

To buy, sell, rent or trade-in this product please click on the link below:
<https://www.avionteq.com/Konica-Minolta-CS-200-Chroma-Meter>



CHROMA METER CS-200

Instruction Manual



Please read before
using this instrument.



KONICA MINOLTA

Safety Symbols

The following symbols are used in this manual to prevent accidents which may occur as a result of incorrect use of the instrument.



Denotes a sentence regarding a safety warning or note.
Read the sentence carefully to ensure safe and correct use.



Denotes a prohibited operation.
The operation must never be performed.



Denotes an instruction.
The instruction must be strictly adhered to.



Denotes an instruction.
Disconnect the AC adapter from the AC outlet.



Denotes a prohibited operation.
Never disassemble the instrument.



This symbol indicates alternating current (AC).



This symbol indicates direct current (DC).













This symbol indicates class II protection against electric shock.

Notes on This Manual

- Copying or reproduction of all or any part of the contents of this manual without KONICA MINOLTA's permission is strictly prohibited.
- The contents of this manual are subject to change without prior notice.
- Every effort has been made in the preparation of this manual to ensure the accuracy of its contents. However, should you have any questions or find any errors, please contact the nearest Konica Minolta-authorized service facility.
- KONICA MINOLTA will not accept any responsibility for consequences arising from the use of the instrument.

Safety Precautions

To ensure correct use of this instrument, read the following points carefully and adhere to them. After you have read this manual, keep it in a safe place where it can be referred to anytime a question arises.

 Warning (Failure to adhere to the following points may result in death or serious injury.)
 Do not use this instrument in places where flammable or combustible gases (gasoline etc.) are present. Doing so may cause fire.
 Always use the AC adapter and power cord supplied as a standard accessory or optional (AC-A305), and connect it to indoor AC outlet of rated voltage and frequency. Failure to follow either of these may result in damage to unit, fire or electric shock.
 If this instrument is not used for a long time, disconnect AC adapter from AC outlet. Accumulated dirt or water on prongs of AC adapter plug may cause fire and should be removed.
 Do not forcibly pull any part on power cord when unplugging since this may damage power cord, resulting in fire or electric shock. Gently disconnect by holding plug. Also, do not handle power cord with wet hands. Doing so may cause electric shock.
 Do not forcibly bend, twist or pull power cord. Also, do not place heavy object on power cord, or damage or modify one. Any of these may cause fire or electric shock due to damage to power cord.
 Do not disassemble or modify this instrument or AC adapter. Doing so may cause fire or electric shock.
 Do not expose this instrument to liquid or metal object which may cause fire or electric shock. Should either of these happen, switch power off and unplug AC adapter immediately. If used on batteries, remove them and contact the nearest <u>Konica Minolta-authorized service facility</u> .
 Do not dispose of batteries in fire, short their terminals, apply heat to them or disassemble them. Doing so may cause explosion or liquid leakage, resulting in fire or injury.
 Should liquid leak from batteries and contact to eye, wash liquid off with clean water without rubbing eyes and immediately seek for medical professional's advice. In case liquid contacts with hand or clothes, wipe it off with plenty of water. Avoid further use of such unit.
 Insulate battery contact with such object as tape in disposing of batteries. Contact to other metal object may cause explosion or fire. Follow local regulation for proper disposal or recycling of batteries.



Should this instrument or AC adapter be damaged or smoke or odd smell be generated, do not keep using such instrument or AC adapter without correction. Doing so may cause fire. In such situations, switch power off immediately, unplug AC adapter (or remove batteries in using ones) and contact the nearest Konica Minolta-authorized service facility.



Do not look at sun or intense light through finder of this instrument. This may lose your sight.



Caution

(Failure to adhere to following points may result in injury or damage to this instrument or other property.)



Use this instrument near AC outlet for easy plugging or unplugging in using AC adapter.



Do not use batteries other than those specified by KONICA MINOLTA. Do not use new and old batteries together or combine different type batteries. When installing batteries in instrument, make sure that they are correctly oriented according to (+) and (-) marks. Failure to any of these may damage battery or liquid leakage, resulting in fire, injury or air pollution.



Do not place this instrument on unstable or sloping surface which may drop or overturn it. Dropping or overturning may injure someone around. Take care not to drop this instrument when carrying it.



Do not move while looking inside finder since this would fall or injure user.



Take special care in handling close-up lens. Breakage of close-up lens may injure someone around.

Introduction

This chroma meter realizes high-precision measurement of luminance and chromaticity comparable to spectroradiometers by the employment of newly developed spectral fitting method. Carefully read this manual before using one.

Packaging material

Retain accompanying packaging materials (carton, protector, and plastic bag) and holding cap (CS-A24) supplied as standard accessory for future usage.

This is delicate measurement instrument. Use packaging materials supplied in purchasing in case this instrument needs to be transferred for such purpose as maintenance in KONICA MINOLTA's factories. These packaging materials are useful for minimizing shock or vibration to this instrument in such situation. Use holding cap for the same purpose especially to protect optical system of this instrument.

Should any of these packaging materials or holding cap (CS-A24) be lost or broken, please contact the nearest Konica Minolta-authorized service facility.

Note on Use

Operating Environment

- Do not use this instrument outdoor since standard accessory AC adapter is designed for indoor use.
- Do not disassemble this instrument for being composed of delicate electronic components.
- Use this instrument at rated voltage of 100 V - 120 V \sim or 200 V - 240 V \sim .
Connect AC power cord to AC outlet with rated voltage and frequency. Connected voltage should not be outside the range of +/-10% of nominal.
- This instrument is classified into a Pollution Degree 2 as instrument used in mainly in manufacturing plant, laboratory, warehouse or equivalents. Use this instrument in metal dust free and non condensing potential environment.
- This instrument is categorized into Installation Category II as equipment connected to commercially available power source.
- Connect PC for controlling this instrument to the outlet with protective grounding. Failure to follow this may result in electric shock due to short circuit.
- Take care not to enter foreign substance like water or metal in this instrument. Operating in such state cause serious danger.
- Do not use this instrument under direct sunlight or near heater. The internal temperature of this instrument to becomes much higher than ambient temperature which may break this instrument.
- Avoid rapid change in ambient temperature which may form dew condensation.
- Avoid using this instrument in extremely dusty or humid place.
- Use this instrument at ambient temperature between 0 and 40°C and relative humidity 85% or less (at 35°C) with no condensation. Operating this instrument outside specified temperature and humidity range may unsatisfy its original performance.

This Instrument

- Do not subject this instrument to strong impact or vibration.
- Do not forcibly pull, bend, or apply strong force to power cord for attached AC adapter or USB cable. This may result in snapping.
- Connect this unit to power source with minimal noise.
- Should breakage or abnormality be found during operation, switch power off immediately and unplug. Then refer to "Error Check" on page 111.
- Should this instrument break down, do not try to disassemble and repair it by yourself. Please contact the nearest Konica Minolta-authorized service facility.
- Warm this instrument up for 15 minutes at least after switching power on when the luminance is 10 cd/m² or lower (measuring angle 1°). This helps to improve the measuring accuracy.

Backup Battery

- Measurement data and settings are stored in memory which is backed up by internal backup battery. Backup battery is charged during operation of this instrument, and can retain memory content for 3 months if it has been fully charged. At the time of purchasing, battery may have already been partially discharged, so switch power on to charge. Battery can be fully charged in 20 hours. Overcharge does not have to be worried about in this case.
- Do not replace internal backup battery (Type: ML2030 3V) by yourself. Please contact the nearest Konica Minolta-authorized service facility.
- We recommend that you should backup important data with data management software CS-S10w Standard Edition as standard accessories to store separately.

Objective and Close-Up lenses (Optional)

- Make sure that surfaces of objective and close-up lenses are clear. Correct measurement may not be performed if there is dirt, dust, hand soil or part left unclean.
- Do not touch surface of objective or close-up lens with hand.
- Do not change ambient temperature rapidly under high humidity. This may mist lens, resulting in incorrect measurement.

Recommended batteries

- Batteries themselves give poor performance at low ambient temperature, which should cause to decrease the measurement frequency. For power source of this instrument, we recommend that you should use the lithium or nickel metal hydride batteries that are hardly affected by temperature change at low ambient temperature.

Storage

Body

- Do not store this instrument under direct sunlight or near heater. The internal temperature of this instrument becomes much higher than ambient temperature which may break this instrument.
- Store this instrument at ambient temperature between 0 and 40°C and relative humidity 85% or less (at 35°C) with no condensation. Storage under high temperature and humidity may deteriorate performance of this instrument. For added safety, we recommend storage with such drying agent at room temperature.
- Take care not to form condensation. Avoid rapid change in ambient temperature when transferring body for storage.
- Put body in packaging box supplied when purchased or optional soft case (CS-A23) to store in safe place.

Objective Lens

- For storage, cover with standard accessory lens cap.

Cleaning

Body

- If this unit becomes dirty, wipe with dry and soft cloth. Do not use organic solvent like benzene or thinner and other chemical agent for cleaning. Should none of these methods be helpful, please contact the nearest Konica Minolta-authorized service facility.

Objective Lens

- Should it be gotten dirt or dust, wipe off with dry and soft cloth or lens cleaning paper. Do not use organic solvent like benzene or thinner and other chemical agent for cleaning. Should none of these methods be helpful, contact the nearest Konica Minolta-authorized service facility.

Notes on transfer

- Use packaging material supplied when purchased to minimize vibration or shock generated during transfer.
- Use holding cap for the same purpose especially to protect optical system of this instrument. Set measuring angle selector at center 0.2° and cover with holding cap (CS-A24) supplied as standard accessory.
- Put all material including unit and accessories in original packaging material when returning this instrument for service.

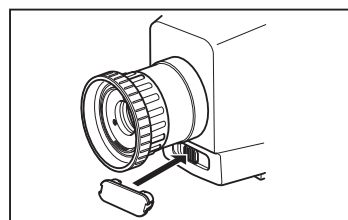

Maintenance

- Periodical checkup is recommended annually to maintain measurement accuracy of instrument. For details on checkup, please contact the nearest Konica Minolta-authorized service facility.

Disposal Method

- Make sure that the instrument, all accessories (including any used batteries), and the packing materials are either disposed of or recycled correctly in accordance with local laws and regulations.

INDEX

Safety Precautions	2
Introduction	3
Note on Use	3
Operating Environment	3
This Instrument	4
Backup Battery	4
Objective and Close-Up lenses (Optional)	4
Recommended batteries	4
Storage.....	5
Body	5
Objective Lens.....	5
Cleaning	5
Body	5
Objective Lens.....	5
Notes on transfer	5
Maintenance	5
Standard Accessory	8
Optional Accessories.....	9
System Configuration	11
Names and Functions of Parts	12
Names of Each Part	12
Inside Finder	12
Functions of Each Part.....	13
Key Panel.....	14
Main Functions of Each Key	14
SHIFT mode.....	15
Indicator Inside Finder	16
1°Aperture.....	16
0.2° Aperture	16
0.1° Aperture	16
Diopter Adjustment	17
LCD Screen.....	18
Measurement Screen.....	18

Installing

Installing	20
Hand Strap	21
Adjusting hand strap	21
How to carry.....	21
Notes on carrying	21
Connecting AC Adapter	22
Connection Method	23
Placing Batteries	24
Note on Use	24
Remaining Battery Level Mark	24
Placing Batteries	25
ON(I)/OFF(O) of Power Switch	26
Turning power switch ON	26
Turning power switch OFF	26

Setting

Selecting Measurement Time	28
Internal Sync Measurement Mode Setting ...	30
Setting Observer.....	32
Selecting Color Space	34
Selecting Absolute Value (ABS)	36
/Difference (DIFF) Display	
Selecting Digit for Chromaticity Display	38
Selecting Lens Type	40
Selecting Single or Continuous Measurement	42
Selecting of Max or Minimum Value Display	44
Opening and Closing of Finder Shutter...	46
Setting of Stored Data Protection ...	48
Setting of Update Method for Memory Channel ...	50
to Store Measurement Value	

Buzzer Setting	52
Backlight ON/OFF	54
Setting Sleep Mode	56
Setting Internal Clock	58

Measurement Preparation

Calibration	62
Calibration Channel	62
User Calibration	63
Implementing User Calibration	64
(1) Through measurement	66
(2) Through selection from saved data ...	68
(3) Copy from other calibration channel	70
Numerical value entry ranges	71
Reset User Calibration	72
Setting CH ID Name	74
Entering Character	77
Setting and Changing Target Color	78
(1) Through user calibration	79
(2) Through measurement	80
(3) Through selection from saved data ...	82
(4) By entering numerical value	84

Measurement

Measurement	88
Measuring distance and measuring area ...	88
Storing Measurement Value.....	90
Displaying Stored Data and	92
Setting Measurement Value ID Name	
Deleting Stored Data	94

Communication

Connecting to PC	98
Remote Mode	99

Description

Principle of Measurement	102
Spectral Fitting Method	102
$L_v T_{\Delta uv}$	103
Dominant Wavelength	104
Measurement of Object Color	106
Operation Procedure	107
(Without data management software CS-S10w)	
Operation Procedure	108
(With data management software CS-S10w)	
Outer Dimensions	109
Error Messages	110
Error Check	113
Identifying Version	116
Changing Luminance Unit (cd/m ² /fL)	118
Specification	120

Standard Accessory

Standard and optional accessories are available with the instrument.

* The shape of some products may be different from those shown.

Lens Cap

- Attached to objective lens for protecting it when not using this instrument.

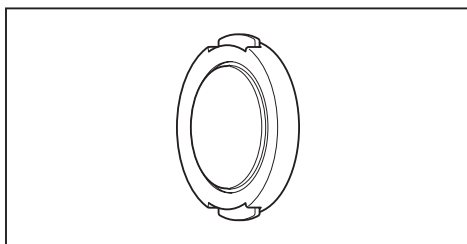

Holding Cap CS-A24

- Prevents measuring angle selector position from deviating during transfer. Remove one when using this instrument and store not to lose. Do not fail to set measuring angle selector at center 0.2° for transfer before attaching this holding cap to measuring angle selector.

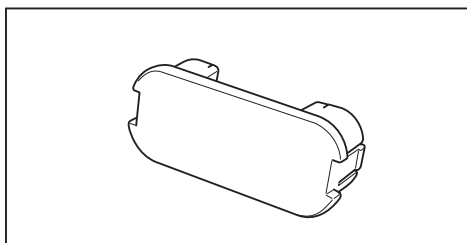

ND Eyepiece Filter CS-A27

- Eases glare when peeping into finder to measure high luminance object. Always set this filter on finder when measuring high luminance object.

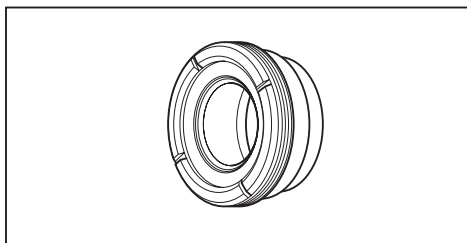

AC Adapter AC-A305

- Supplies power from AC outlet.
Input: 100 V - 240 V \sim , 24 - 38 VA,
0.24 - 0.16 A, 50/60 Hz
Output: 5 V \equiv 2.0 A

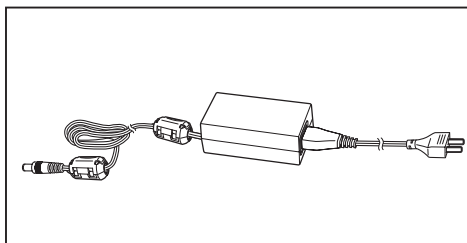

Data Management Software CS-S10w Standard

- Software to control this instrument from PC for data management

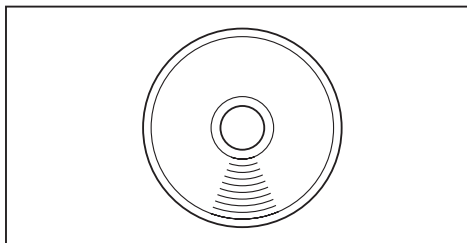

USB Cable (2 m) IF-A33

- Used for communication between this instrument and PC.

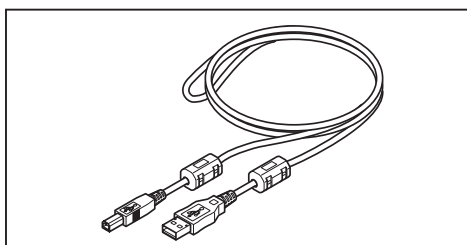

Optional Accessories

Close-Up lens No.107

Close-Up lens No.122

- Placed before objective lens for measurement of small object.

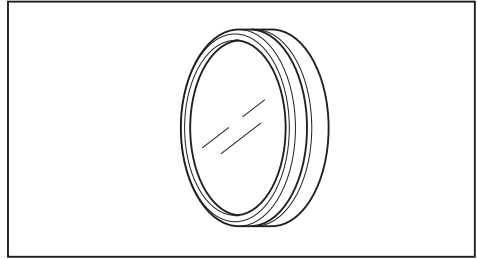

ND Filter (1/10) CS-A6

ND Filter (1/100) CS-A7

- Placed before objective lens for measurement of high luminance object, but sandwich step up ring (40.5 to 55 mm) CS-A26 inbetween.

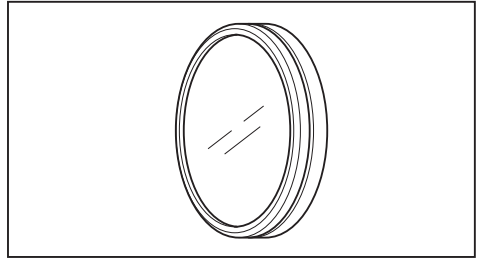

Calibration Certificate (For ND Filter)

- Calibration certificate is available for ND filters (1/10) CS-A6 and (1/100) CS-A7.

Step Up Ring (40.5 to 55 mm) CS-A26

- Placed before objective lens in using ND filters (1/10) CS-A6 or (1/100) CS-A7.

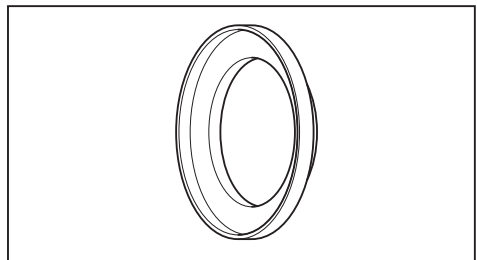

White Calibration Plate (For 45/0) CS-A20

White Calibration Plate (For d/0) CS-A21

- Used for measurement of object colors.

White Calibration Plate Set CS-A22

- A set of white calibration plates (For 45-0) CS-A20 and (For d-0) CS-A21.

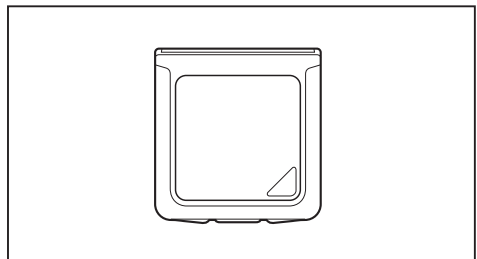

Soft Case CS-A23

- Used to keep this instrument and accessories or carry them with hand. Never use for transfer.

**Data Management Software****CS-S10w Professional**

- Enables multiple data management thanks to additional functions to that for CS-S10w Standard.

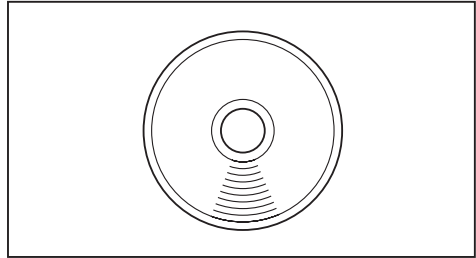

System Configuration

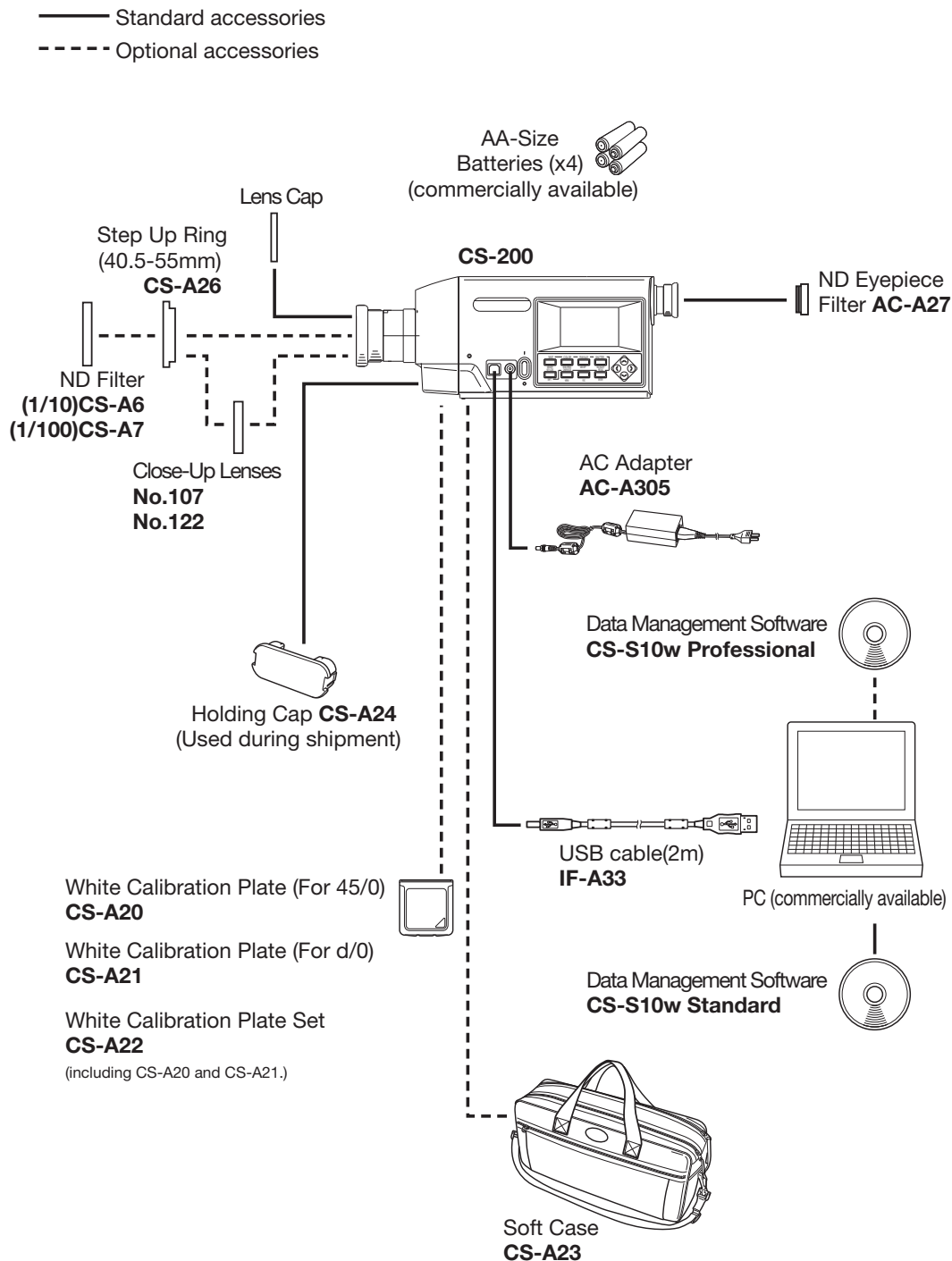

Names and Functions of Parts

Names of Each Part

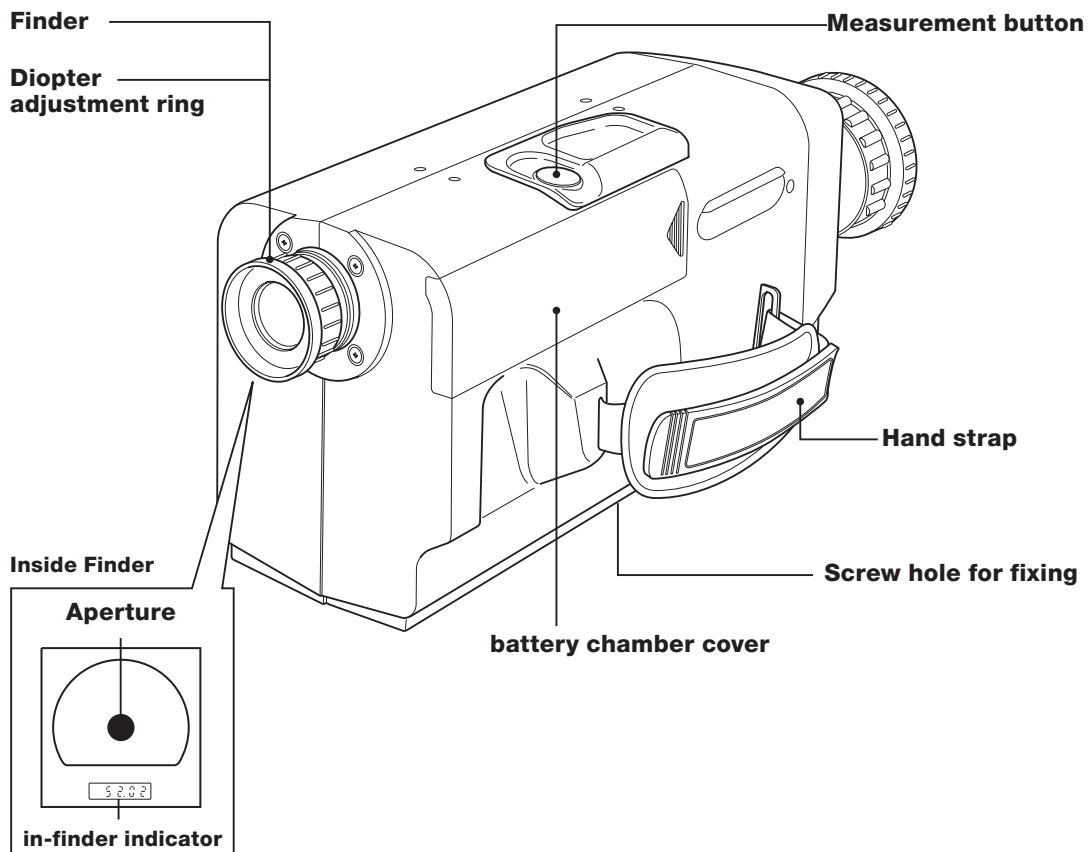
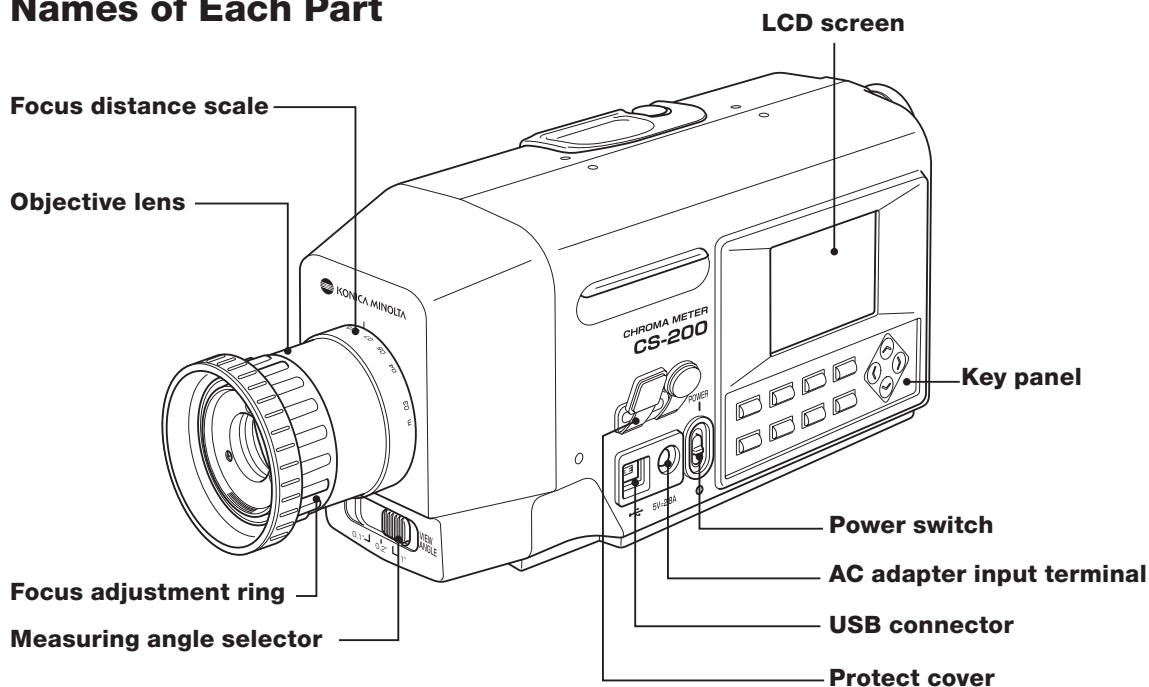

Functions of Each Part

Power switch:(p.23)

Switches this instrument on/off. (I) for ON; (O) for OFF

AC adapter input terminal:(p.23)

To which accessory AC adapter is connected.

USB connector: (p.98)

To which USB cable is connected when used with PC.

Measuring angle selector: (p.88)

Used to select measuring angle among 1°, 0.2° and 0.1°.

Protect cover: (p.23,98)

Protects AC adapter input terminal and USB connector.

Objective lens:

Directed to object for measurement.

Focus adjustment ring: (p.88)

Adjusts focus of objective lens before measurement.

Focus distance scale: (p.88)

Helps adjusting focus.

LCD screen: (p.18)

Displays various screens like measurement and menu.

Key panel: (p.14)

Offers several keys for operation of this instrument.

Measurement button: (p.88)

For measurement. Stops measurement when pressed during measurement.

Finder: (p.16, 88)

Used to observe object for measurement.

Diopter adjustment ring: (p.17,88)

Adjusts diopter.

Aperture: (p.16)

Indicates measuring area. Size of black circle will change depending on measuring angle.

In-finder indicator: (p.16)

L_v value appears on in-finder indicator.

Hand strap: (p.21)

Used to carry this instrument with hand.

Screw hole for fixing: (p.20)

Used to fix this instrument with tripod or jig.

Battery chamber: (p.25)

Used to set the batteries.

Key Panel

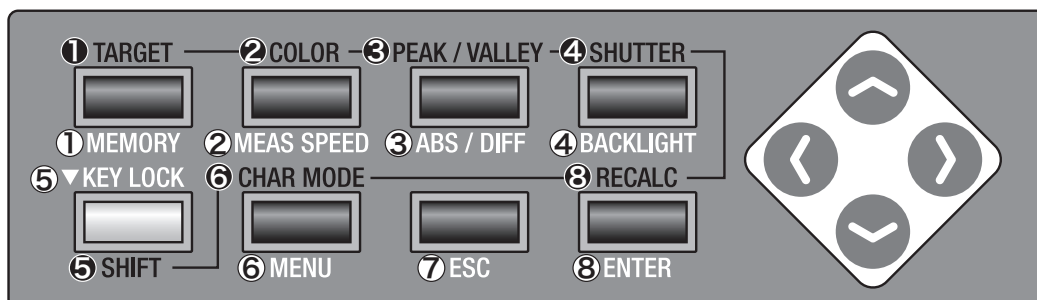

Main Functions of Each Key

- ① MEMORY** Measured data is stored in memory by pressing this key when measurement screen and save screen appears.
- ② MEAS SPEED** Measurement time is switched in order AUTO → LTD. AUTO → Super-FAST → FAST → SLOW → Super-SLOW → MANUAL → AUTO if pressed when screen with which measurement is available.(p.28)
- ③ ABS/DIFF** Selects whether chromaticity is displayed in absolute value (ABS) or difference (DIFF) if pressed when measurement screen appears.(p.36)
- ④ BACKLIGHT** Selects backlight ON/OFF on LCD screen.(p.54)
- ⑤ KEY LOCK** Switches between valid/invalid for acceptance of each key operation after being kept pressed for at least 2 seconds approximately.
- ⑥ MENU** Menu screen appears if pressed when measurement or save screen appears. In case of menu screen, screen switches in order of menu 1/4 → menu 2/4 → menu 3/4 → menu 4/4 → menu 1/4.
- ⑦ ESC** To return to measurement screen if pressed when menu or target value setting screen appears. If pressed when entering numerical value or making various settings, setting is stopped.
- ⑧ ENTER** To enter numerical value with or fix settings.

SHIFT mode

Press **5** SHIFT key to switch between SHIFT mode and normal mode. In SHIFT mode, keys from **1** to **4**, **6** and **8** become valid; in normal mode, keys from **1** to **4**, **6** and **8** become valid. Keys of **5**, **7** and **9** are always valid either in SHIFT mode or normal mode.

1TARGET

To go to target value setting screen from either measurement or save screen.

2COLOR

If pressed when screen with which measurement is available, color space is switched in order of $L_vxy \rightarrow L_vu'v' \rightarrow L_vT(d)uv \rightarrow XYZ \rightarrow$ dominant wavelength $\rightarrow L_vxy$.(p.35)

3PEAK/VALLEY

Switched to either of normal measurement, PEAK (Max. value appears for continuous measurement) or VALLEY (Minimum value appears for continuous measurement.) screen if pressed when measurement screen appears.(p.44)

4SHUTTER

Selects whether finder shutter automatically closes for each measurement or always opens if pressed when screen with which measure is available. To close automatically, **[●]** appears on bottom left of screen and **[○]** to always keep opened.(p.48)

5SHIFT

Selects either SHIF1 mode/ Normal mode. For SHIFT mode, **[SFT]** appears on bottom left of screen and keys from **1** to **4**, **6**, and **8** become valid. In case of normal mode, **[]** appears on bottom left of screen and keys from **1** to **4**, **6**, and **8** become valid.

6CHAR MODE

If pressed when screen where ID is to input, character type to enter switches in order of Capital Alphabet \rightarrow Sm all Alphabet \rightarrow Numerical Value \rightarrow Symbol \rightarrow Capital Alphabet. (p.77)

8RECALC

Pressed when calibration channel is changed for measurement value on measurement screen. Measurement value is recalculated.(p.89)

↶key, **↷**key

If pressed when measurement or save screen appears, calibration channel is changed in SHIFT mode; memory channel is changed in normal mode.

If pressed when entering numerical value or making various settings, numerical value or setting is changed.

⬅ key, **➡**key

If pressed when measurement or save screen appears, the screen switches between measurement and save screen.

If pressed when entering numerical value or making various settings, cursor position is moved.

Indicator Inside Finder

1° Aperture

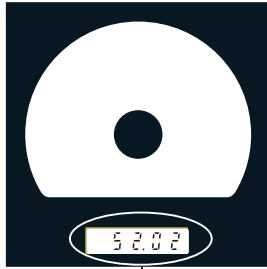

0.2° Aperture

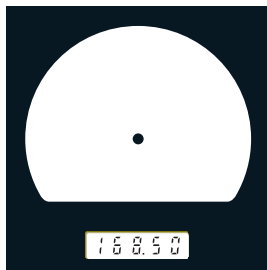

0.1° Aperture

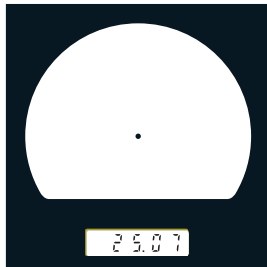

**L_v value appears
on in-finder indicator.**

K (displayed as $\overset{K}{\uparrow}$) and
M (displayed as $\overset{M}{\uparrow}$) show
 $\times 10^3$ and $\times 10^6$ respectively.

Diopter Adjustment

Rotate diopter adjustment ring for adjustment of diopter.

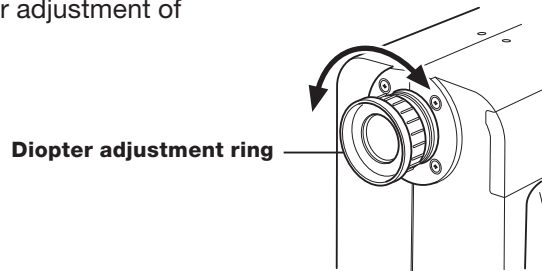

Adjust so that A or B on aperture or black circle indicating measuring area looks clear when observing object through finder.

Adjustment would be easy starting with 1° aperture where object near aperture looks blur.

Make sure to adjust diopter before measurement. Diopter should be adjusted for the eyesight of the person who will be taking measurement. If diopter is not adjusted before focus measurement, correct measurement value may not be expected. This is because the focus is actually off even if you think it is correctly in focus. In addition, if diopter is not correctly adjusted, you may see the aperture moving depending on viewing angle.

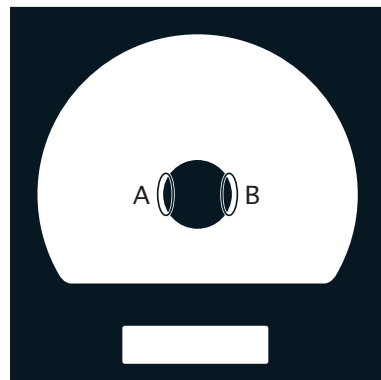

*You sometimes see small black dots or stripes in internal finder. This happens due to characteristics of optical system, not dust or dirt in internal finder. It gives no effect on measuring performance.

LCD Screen

Measurement Screen

CH ID name(p.74)

Calibration channel(p.62)

<PEAK> is displayed when the measurement result was obtained at <PEAK> for “Continuous mode”; <VALLEY> is displayed when the measurement result was obtained at <VALLEY> for “Continuous mode”.(p.44)
Nothing is displayed here when it was obtained at “Single measurement” or normal screen for “Continuous mode”.

Measurement result is displayed in the currently selected color space. (L_v,x_y, L_vu'v', L_vTΔuv, XYZ ,Dominant wavelength)(p.34)

SINGLE is displayed when the measurement mode is set to “Single measurement”; CONT. is displayed when set to normal screen for “Continuous mode”. (p.42)

Nothing is displayed here when set to <PEAK> or <VALLEY> for “Continuous mode”.

Setting status in this instrument is displayed.

<ANGL>

Currently selected measuring angle is displayed.(1°,0.2°,0.1°)(p.88)

<SPD>

Currently selected measuring time is displayed.(AUTO,LTD.AUTO, S-FAST, FAST, SLOW, S-SLOW, MANU)(p.28)

<SYNC>

Synchronization frequency is displayed when internal sync measurement mode is set; NO SYNC is displayed when it is not set.(p.30)

<LENS>

Currently selected lens type is displayed. (STANDARD,No.107,No.122)(p.40)

<MEM>

Update method for directory to store measurement value is displayed.(AUTO NUM,MAN NUM,AUTOSAVE)(p.46)

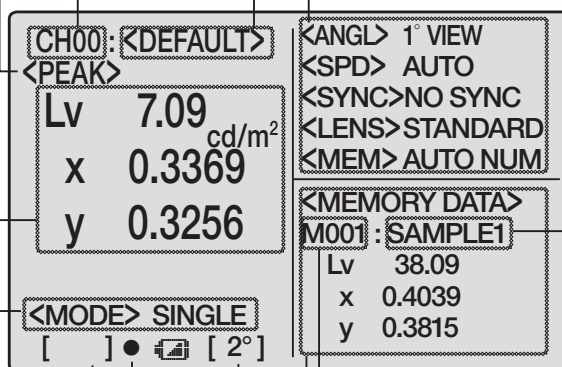

Measurement value ID name (p.92)

Memory channel

Stored data is displayed.(p.90)

Currently selected observer angle is displayed.(2°,10°)(p.32)

Battery level mark ( , )(p.24)

● is displayed when the finder shutter is set to automatically close for every measurement; ● is displayed when set to always open.(p.48)

[SFT] is displayed when this instrument is in SHIFT mode; [] is displayed when SHIFT mode is released.

Installing

Installing

Use screw hole for fixing at the bottom of this instrument if utilized with tripod or jig. 2 type holes are available.

Tripod screw hole : To set on tripod. Screw depth is 6.5 mm.

ISO screw hole : To set on jig. Use ISO screw with top diameter of 5mm and depth of 6.5 mm.

Standard plane for distance measurements

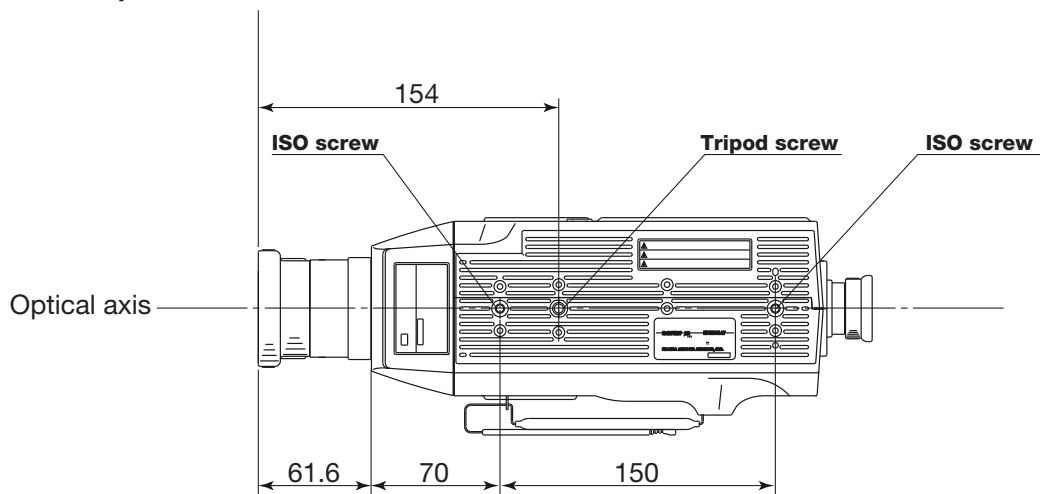

For other detailed dimensions, see p.109.

Hand Strap

Hand strap can be used to carry this instrument with hand.

Adjusting hand strap

Insert your right hand between this instrument and hand strap, and adjust hand strap so that your hand securely fits to the instrument without any gap.

How to carry

As shown in the figure, insert your right hand through hand strap and support the bottom close to objective lens with your left hand. Tighten your arms to carry it more securely.

Notes on carrying



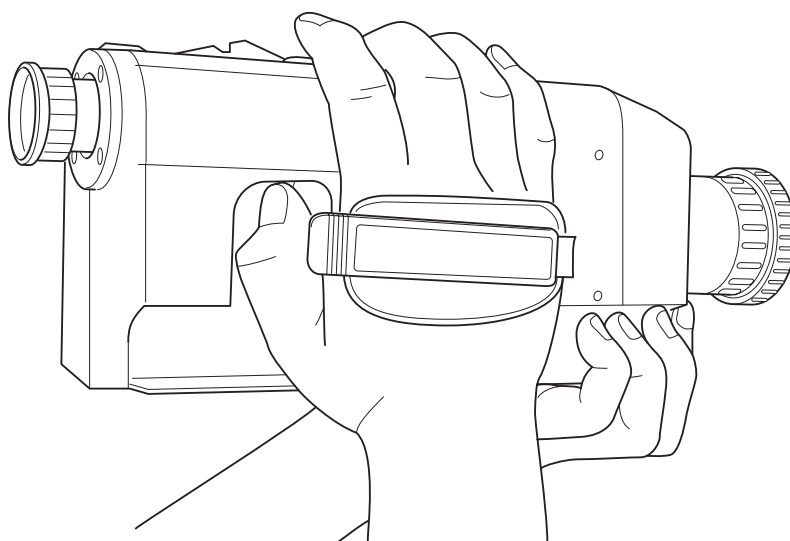



Be careful not to thud this instrument when carrying. You must always insert your right hand through hand strap.





Connecting AC Adapter

Either AC adapter(accessory) or 4 AA size batteries(commercially available) can be used as power source of this instrument.

 **Warning** (Failure to adhere to the following points may result in death or serious injury.)

-  Always use the AC adapter and power cord supplied as a standard accessory or optional (AC-A305), and connect it to indoor AC outlet of rated voltage and frequency. Failure to follow either of these may result in damage to unit, fire or electric shock.
-  If this instrument is not used for a long time, disconnect AC adapter from AC outlet.
Accumulated dirt or water on prongs of AC adapter plug may cause fire and should be removed.
-  Do not forcibly pull any part on power cord when unplugging since this may cause fire or electric shock. Gently disconnect by holding plug. Also, do not handle power cord with wet hands. Doing so may cause electric shock.
-  Do not forcibly bend, twist or pull power cord. Also, do not place heavy object on power, or damage or modify one. Any of these may cause fire or electric shock due to damage to power cord.
-  Do not disassemble or modify this instrument or AC adapter. Doing so may cause fire or electric shock.
-  Should this instrument or AC adapter be damaged or smoke or odd smell be generated, do not keep using one without correction. Doing so may cause fire. In such situations, switch power off immediately, unplug AC adapter (or remove batteries in using ones) and contact the nearest Konica Minolta-authorized service facility.



 **Caution** (Failure to adhere to following points may result in injury or damage to instrument or other property.)

-  Use this instrument near AC outlet for easy plugging or unplugging in using AC adapter.

Connection Method

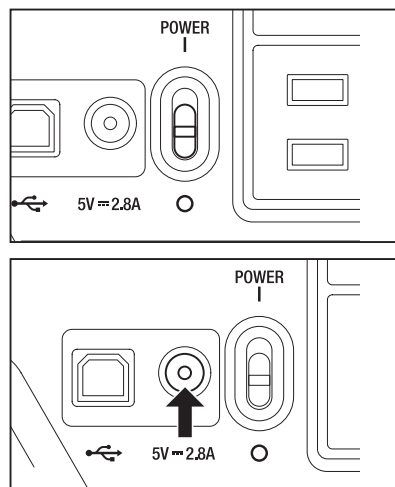



- 1. Make sure that power switch is OFF (slided to [O] mark side).**
- 2. Lift protect cover and connect AC adapter plug to AC adapter input terminal on body.**
- 3. Plug AC adapter to outlet (AC 100V-120V \sim or 200-240V \sim , 50 Hz/60 Hz).**





Insert AC adapter plug all the way seated in AC outlet. If not,  may appear when turning power switch on. Turn power switch off once and unplug AC adapter before resuming. (See p.24 for details on  mark.)

Placing Batteries

 **Warning** (Failure to adhere to the following points may result in death or serious injury.)

-  Do not dispose of batteries in fire, short their terminals, apply heat to them or disassemble them. Doing so may cause explosion or liquid leakage, resulting in fire or injury.
-  Should liquid leak from battery and contact to eye, wash liquid off with clean water without rubbing eyes and immediately seek for medical professional's advice. In case liquid contacts with hand or clothes, wipe liquid off with plenty of water. Avoid further use of such instrument.
-  Insulate battery contact with such object as tape in disposing of batteries. Contact to other metal object may cause heat, explosion or fire. Follow local regulation for proper disposal or recycle of batteries.
-  Should instrument or AC adapter be damaged or smoke or odd smell be generated, do not keep using it without correction. Doing so may cause fire. In such situations, switch power off immediately, unplug AC adapter (or remove batteries in using ones) and contact the nearest Konica Minolta-authorized service facility.

 **Caution** (Failure to adhere to following points may result in injury or damage to instrument or other property.)

-  Do not use batteries other than those specified by KONICA MINOLTA. Or do not use new and old batteries together or combine different type batteries. When installing batteries in this instrument, make sure that they are correctly placed according to (+) and (-) marks. Failure to any of these may damage battery or leak liquid, resulting in fire, injury or air pollution.

Note on Use



Remove batteries if unused for 2 weeks or longer. If not, liquid in battery may leak, which would damage this instrument.

To avoid draining of battery, sleep mode setting is available for the case not using for 30 minutes. See p.56 for details.

If batteries are installed and AC adapter is used, power is supplied through AC adapter.

Remaining Battery Level Mark

Mark indicating remaining battery level appears on bottom left of LCD screen.

-  mark indicates that remaining battery level is low. If this appears, replacement with new ones or AC adapter connection is recommended.
-  mark indicates that there is no battery left. This instrument cannot be used. Replace with new ones or connect AC adapter.

Make sure that power switch is off before replacing batteries or connecting AC adapter.

Placing Batteries

1. Make sure that power switch is OFF (slided to [O] mark side).

2. Open battery chamber cover while pressing and sliding  mark to the direction shown in illustration.

3. Place 4 AA size batteries following polarity indication in battery chamber.

Do no touch or short terminals in battery chamber. Doing so may cause breakage of this instrument.

Use alkaline-manganese, lithium, or nickel-metal-hydrate batteries.

4. Slide battery chamber cover to the direction shown in illustration and close until clicking.

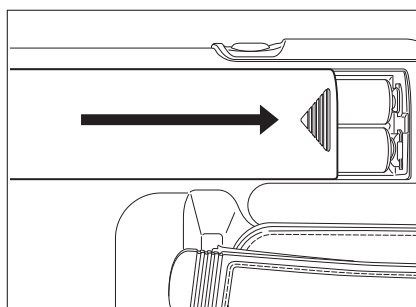
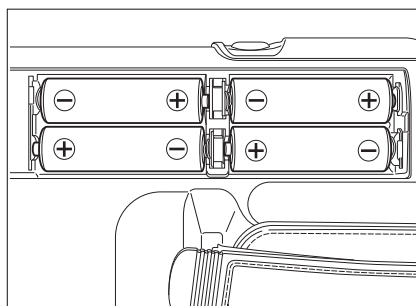
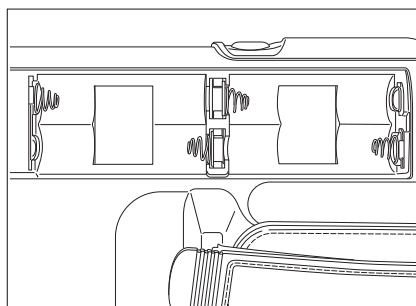
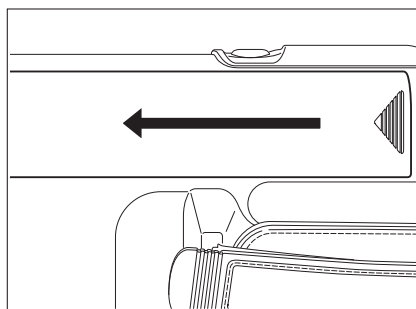
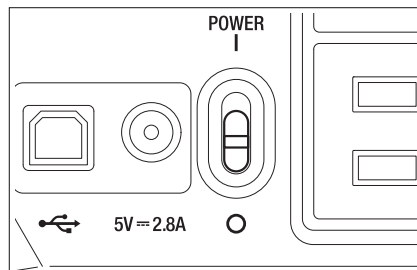

ON(I)/OFF(O) of Power Switch

To secure accurate measurement in either of following situations, 15-minute warm-up is recommended at least.

1. Measuring low luminance light source object: At 2856K (Standard light source A) as measuring stick
 - 10cd/m² or lower (1° Aperture)
 - 250cd/m² or lower (0.2° Aperture)
 - 1000cd/m² or lower (0.1° Aperture)
2. Outside room temperature and normal humidity ranges

Turning power switch ON

1. Slide power switch to ON (I) side.

Measurement screen appears 5 seconds after initial screen on LCD.

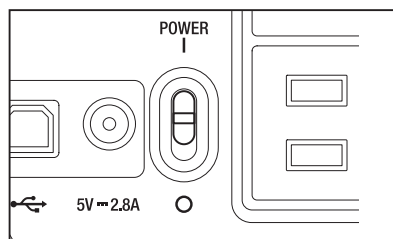

Turning power switch OFF

2. Slide power switch to OFF (O side) after measurement.

After measurement, do not switch OFF until measurement value appears. When message "PLEASE WAIT..." appears, do not switch OFF, either. Doing so may break stored data.

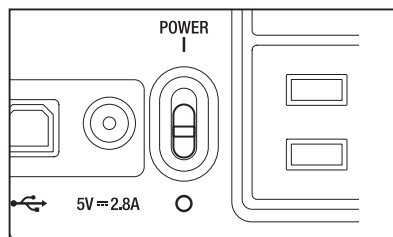

Setting

Selecting Measurement Time

Select measurement time depending on purpose.

7 modes are available for measurement time.

Select the mode with long measurement time when repeated accuracy is required such as when measuring object of low luminance.

* Setting at the shipment from factory : AUTO.

	Zero Calibration	Measurement Time calculated by formula (Time for integration x 2 + Time to open/close shutter + Time for calculation) indicating time needed for actual measurement.	Time for integration Time for sensor to measure light indicating "exposure time".
Super-FAST	Not be done every time *1	0.5s approx.	300 ms
FAST	Done every time automatically	1s approx.	300 ms
SLOW		3s approx.	1300 ms
Super-SLOW		12s approx.	1300 ms x 4 times
LTD.AUTO ※2		1s or 3s approx.	300 ms or 1300 ms
AUTO ※3		1s to 60 s	
MANUAL		1s to 60 s (Every 1s)	

* Zero calibration is performed automatically one minute after previous measurement.

* 2 Selects FAST/SLOW automatically depending on luminance. Luminance for which FAST/SLOW is switchable is as follows for measuring angle 1°.

FAST → SLOW: $L_v=20 \text{ cd/m}^2$ or lower (Measurement is redone in SLOW mode.)

SLOW → FAST: $L_v=40 \text{ cd/m}^2$ pt or higher

* 3 Selects the measurement time automatically depending on luminance.

For measuring angle 1°, when luminance is higher than 20 cd/m^2 , the measurement time switches as LTD.

AUTO mode. When luminance is 20 cd/m^2 or lower, the measurement time is calculated depend on luminance as following examples. The higher limit is 60 s.

L_v	20.0 cd/m^2	15.0 cd/m^2	10.0 cd/m^2	6.6 cd/m^2	4.6 cd/m^2
Measurement Time	3 s approx.	7 s approx.	14 s approx.	30 s approx.	60 s approx.

Operation Procedure

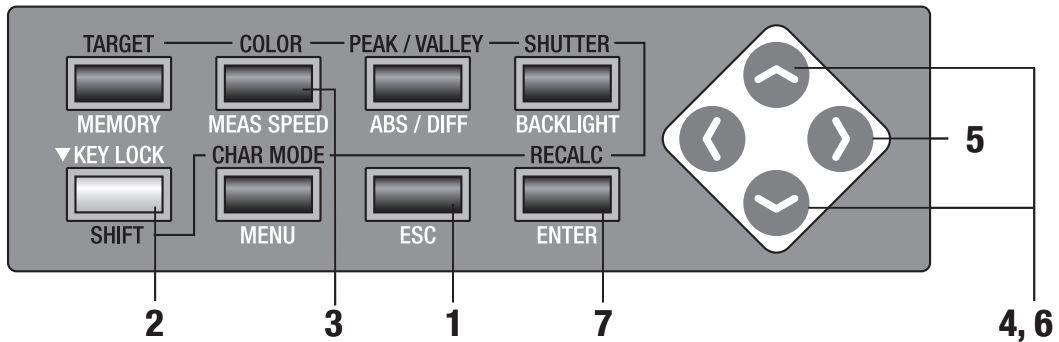

1. Press **ESC** key when menu or target value setting menu appears.
Measurement screen appears on LCD screen.

2. Make sure that [] appears on bottom left of measurement screen indicating it has not been set for SHIFT mode.

If [SFT] appears instead, it means that instrument is operate in SHIFT mode.
Press **SHIFT** key to cancel SHIFT mode.

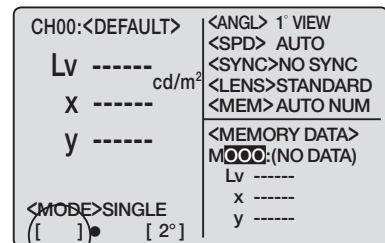

3. Press **MEAS SPEED** key to select measurement speed.

<SPD> switches in order of AUTO → LTD.AUTO → S-FAST → FAST → SLOW → S-SLOW → MANU → AUTO while this key is pressed.

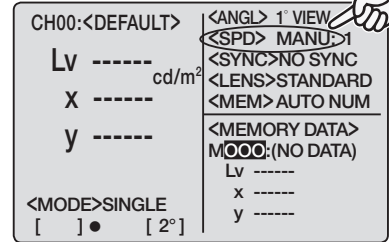

MANU Setting

Screen to set measurement time from appears.

4. Press either or key to set value.

 key for larger number. If kept pressed, value continuously increases.

 key for smaller number. If kept pressed, value continuously becomes small.

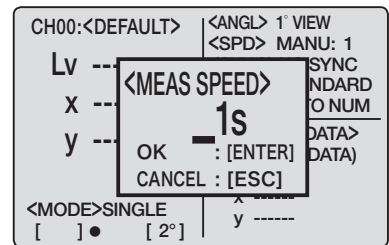

5. press key to move cursor to second digit position.

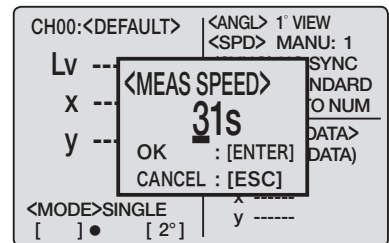

6. Press either or key to set value.

Selectable measurement time range is 1 to 60 sec. Press **ESC** key to stop.

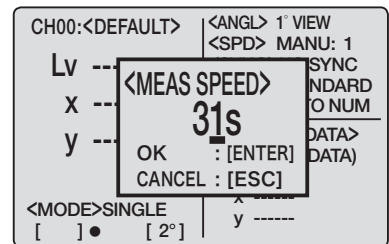

7. Press **ENTER** key to fix measurement time.

Measurement time setting remains even after switching OFF (O).

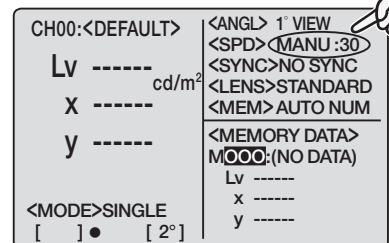
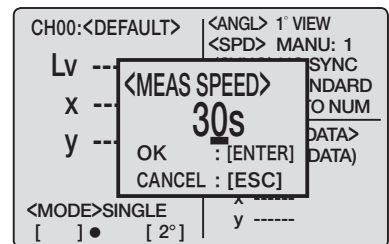

Internal Sync Measurement Mode Setting

Internal sync measurement mode refers to measurement mode where measurement is made in the same timing as periodical light source pulse frequency, such as vertical synchronization frequency for display.

* Setting at the shipment from factory : NO SYNC

Operation Procedure

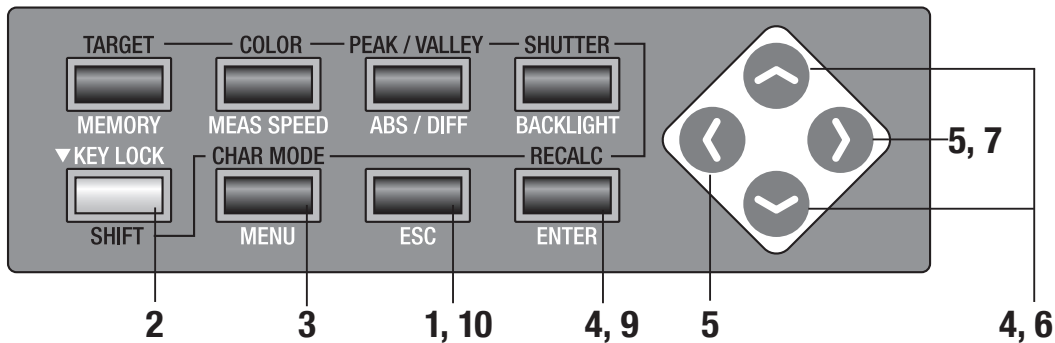

1. Press **ESC** key when menu or target value setting menu appears.

Measurement screen appears on LCD screen.

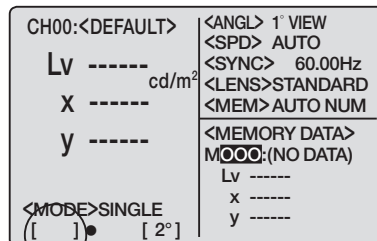

2. Make sure that [] is shown on bottom left of measurement screen indicating it has not been set for SHIFT mode.

If [SFT] appears instead, it means that instrument is to operate in SHIFT mode. Press **SHIFT** key to cancel SHIFT mode.

3. Press **MENU** key.

Menu 1/4 screen appears on LCD screen.

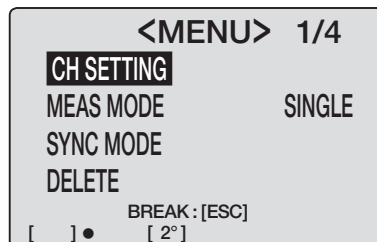

4. Press either or key to select [SYNC MODE] and then **ENTER** key.

< SYNC MODE > screen appears on LCD screen.

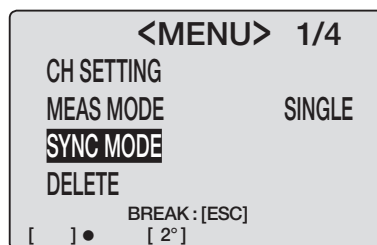

5. Press either **→** or **←** key to move inversion cursor from [NO SYNC] to [SYNC] so that light source pulse frequency can be entered.

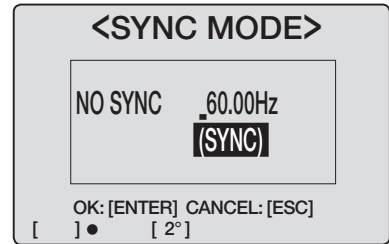

6. Press either **↑** or **↓** key to set arbitrary value.

↑ key: 0 to 9 (0 to 2 in 100 position) in descending order, decimal point and space available. If kept pressed, numerical value continuously increases.

↓ key: 9 to 0 (2 to 0 in 100 position) in ascending order, decimal point and space available. If kept pressed, numerical value continuously becomes small.

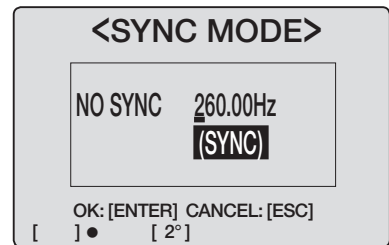

7. Press **→** key to move cursor to second digit position.

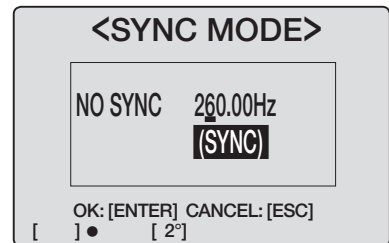

8. Repeat the same procedures 6. and 7. as necessary.

Selectable frequency range is from 40.00Hz to 200.00Hz. Press **ESC** to stop.

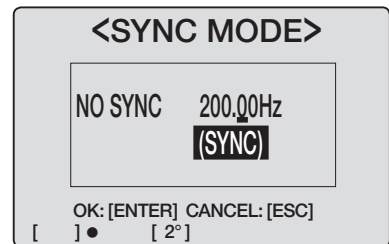

9. Press **ENTER** key to show <MENU>1/4 screen.

Now frequency has been set.

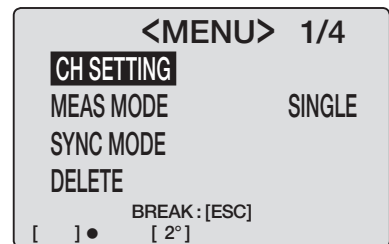

10. Press **ESC** to return to measurement screen.

Internal sync mode setting remains even after switching OFF (O).

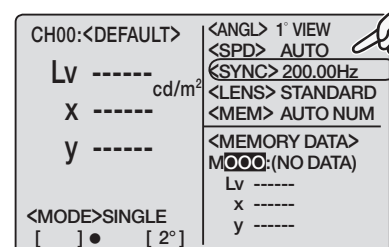

Setting Observer

Color matching function for chromaticity calculation is selectable between 2° and 10°.

* Setting at the shipment from factory : 2° OBS

Operation Procedure

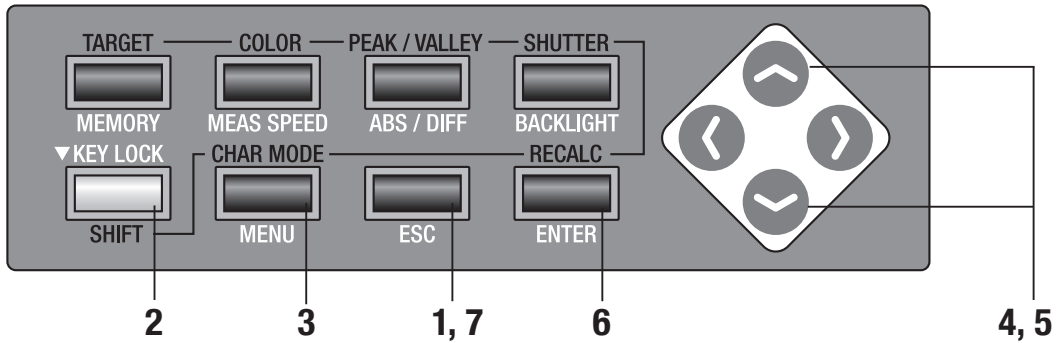

1. Press **ESC** key when menu or target value setting menu appears.
Measurement screen appears on LCD screen.

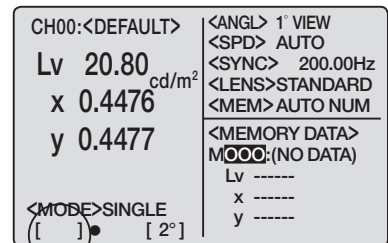

2. Make sure that [] appears on left bottom indicating this instrument has not been set for **SHIFT** mode.
If [SFT] appears instead, it means that instrument is to operate in SHIFT mode.
Press **SHIFT** key to cancel SHIFT mode.

3. Press **MENU** key four times.
Menu 4/4 screen appears on LCD screen.

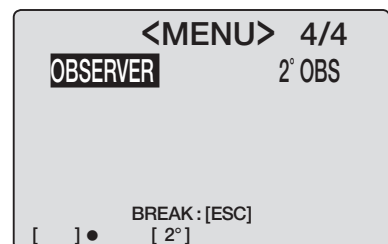

4. Press **ENTER** key.
Inversion cursor moves from [OBSERVER] to right to change observer angle.

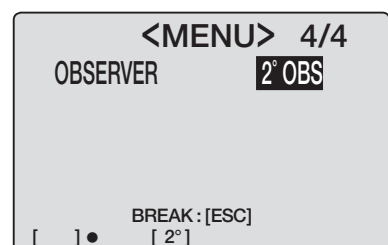

5. Press either  or  key to set either for [2°OBS] or [10°OBS].

Press **ESC** key to stop.

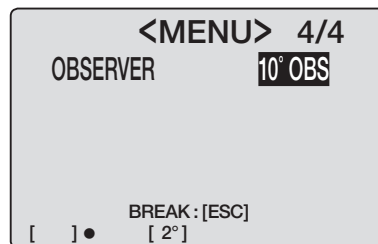

6. Press **ENTER key.**

After “**PLEASE WAIT...**” appears, inversion cursor moves from [**OBSERVER**] to right to change observer angle.

When “**PLEASE WAIT...**” appears, do not switch OFF. Doing so may break stored data.

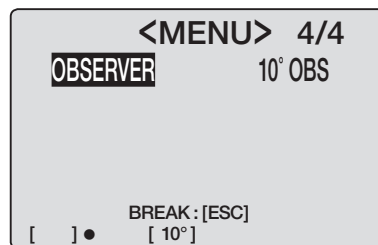

7. Press **ESC key to return to measurement screen.**

Setting remains even after switching OFF (O).

When observer angle is set to 10°, Lv display changes to Y display. Lv and Y display in stored data is retained after changing observer angle.

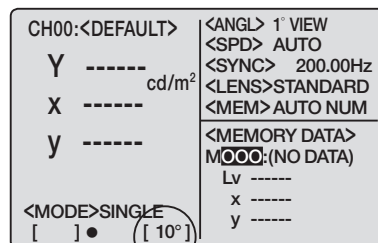

Selecting Color Space

See below table for available color space.

* Setting at the shipment from factory : L_vxy

Color space	LCD Screen	Display Description
L_vxy *1	<pre> CH00:<DEFAULT> <ANGL> 1° VIEW <SPD> AUTO <SYNC>200.00Hz Lv ----- cd/m² x ----- <LENS>STANDARD <MEM>AUTO NUM y ----- <MEMORY DATA> M000:(NO DATA) Lv ----- x ----- y ----- <MODE>SINGLE [] ● [2°] </pre>	Displayed and output in luminance L_v and chromaticity coordinates x, y .
$L_vu'v'$ *1	<pre> CH00:<DEFAULT> <ANGL> 1° VIEW <SPD> AUTO <SYNC>200.00Hz Lv ----- cd/m² u' ----- <LENS>STANDARD <MEM>AUTO NUM v' ----- <MEMORY DATA> M000:(NO DATA) Lv ----- x' ----- y' ----- <MODE>SINGLE [] ● [2°] </pre>	Displayed and output in luminance L_v and $u'v'$ chromaticity diagram (CIE 1976 UCS chromaticity diagram) coordinates u', v'
$L_v T \Delta uv$ *2	<pre> CH00:<DEFAULT> <ANGL> 1° VIEW <SPD> AUTO <SYNC>200.00Hz Lv ----- cd/m² T ----- K Δuv ----- <LENS>STANDARD <MEM>AUTO NUM <MEMORY DATA> M000:(NO DATA) Lv ----- T ----- Δuv ----- <MODE>SINGLE [] ● [2°] </pre>	Displayed and output in luminance L_v , correlated color temperature T and color difference from blackbody locus Δuv .
XYZ	<pre> CH00:<DEFAULT> <ANGL> 1° VIEW <SPD> AUTO <SYNC>200.00Hz X ----- <LENS>STANDARD <MEM>AUTO NUM Y ----- <MEMORY DATA> M000:(NO DATA) X ----- Y ----- Z ----- Z ----- <MEMORY DATA> M000:(NO DATA) X ----- Y ----- Z ----- <MODE>SINGLE [] ● [2°] </pre>	Displayed and output in tristimulus values X, Y, Z .
Dominant wavelength*3	<pre> CH00:<DEFAULT> <ANGL> 1° VIEW <SPD> AUTO <SYNC>200.00Hz λd ----- nm <LENS>STANDARD <MEM>AUTO NUM <MEMORY DATA> M000:(NO DATA) Δd ----- <MODE>SINGLE [] ● [2°] </pre>	Displayed and output in dominant wavelength λd .

*1 Y is displayed instead of L_v when observer angle is 10° .

*2 Not displayed when observer angle is 10° .

*3 For non-spectral colors, the complementary wavelength will be displayed. However, the display indication will remain λd .

Operation Procedure

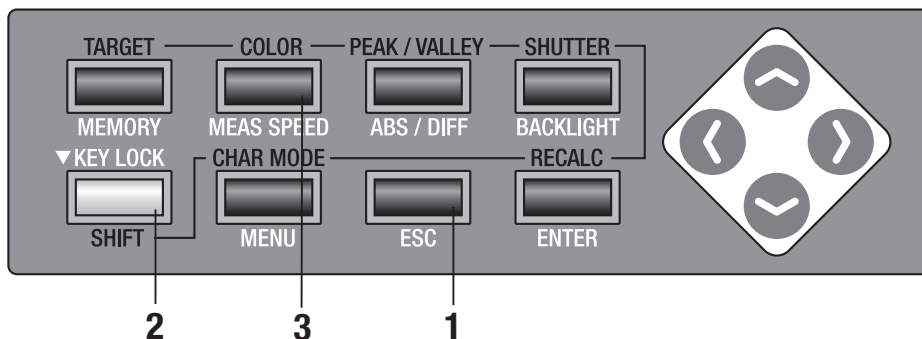

1. Press **ESC** key when menu or target value setting menu appears.
Measurement screen appears on LCD screen.

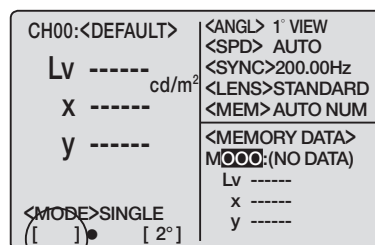

2. Press **SHIFT** to switch to **SHIFT** mode.
[SFT] appears on bottom left of measurement screen. Or make sure that [SFT] appears on left bottom indicating that this instrument has been operated in SHIFT mode.

3. Press **COLOR** key to select color space.

Measurement screen switches in order of $L_{vxy} \rightarrow L_{vu'v'} \rightarrow L_{vT\Delta uv} \rightarrow XYZ \rightarrow \lambda d \rightarrow L_{vxy}$ in SHIFT mode while **COLOR** key is pressed.

It switches in order of $Y_{xy} \rightarrow Y_{u'v'} \rightarrow XYZ \rightarrow \lambda d \rightarrow Y_{xy}$ when observer angle is 10° .

Color space setting remains even after switching OFF (O).

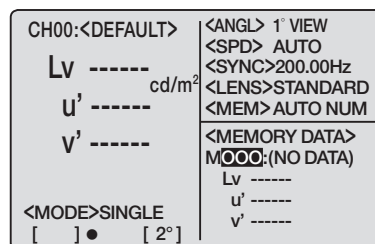

Selecting Absolute Value (ABS)/Difference (DIFF) Display

Whether chromaticity value is shown in absolute (ABS) or difference (DIFF) is selectable. See below table for each case.

* Setting at the shipment from factory : Absolute value (ABS)

Color Space	Switching between Absolute Value (ABS) and Difference (DIFF) Dominant wavelength		
L_Vxy *1	$L_V \cdot x \cdot y$ <div style="border: 1px solid black; padding: 5px; margin-top: 5px;"> CH00:<DEFAULT> <ANGL> 1 VIEW <SPD> AUTO <SYNC>200.00Hz <LENS>STANDARD <MEM>AUTO NUM <MEMORY DATA> M000:(NO DATA) Lv ----- x ----- y ----- <MODE>SINGLE [] ● [2°] </div>	$\%L_V \cdot \Delta L_V \cdot \Delta x \cdot \Delta y$ <div style="border: 1px solid black; padding: 5px; margin-top: 5px;"> CH00:<DEFAULT> <ANGL> 1 VIEW <SPD> AUTO <SYNC>200.00Hz <LENS>STANDARD <MEM>AUTO NUM <MEMORY DATA> M000:(NO DATA) %Lv ----- % ΔLv ----- cd/m² Δx ----- Δy ----- <MODE>SINGLE [] ● [2°] </div>	
$L_Vu'v'$ *1	$L_V \cdot u' \cdot v'$ <div style="border: 1px solid black; padding: 5px; margin-top: 5px;"> CH00:<DEFAULT> <ANGL> 1 VIEW <SPD> AUTO <SYNC>200.00Hz <LENS>STANDARD <MEM>AUTO NUM <MEMORY DATA> M000:(NO DATA) Lv ----- u' ----- v' ----- <MODE>SINGLE [] ● [2°] </div>	$\%L_V \cdot \Delta L_V \cdot \Delta u' \cdot \Delta v'$ <div style="border: 1px solid black; padding: 5px; margin-top: 5px;"> CH00:<DEFAULT> <ANGL> 1 VIEW <SPD> AUTO <SYNC>200.00Hz <LENS>STANDARD <MEM>AUTO NUM <MEMORY DATA> M000:(NO DATA) %Lv ----- % ΔLv ----- cd/m² Δu' ----- Δv' ----- <MODE>SINGLE [] ● [2°] </div>	
$L_V T \Delta uv$ *2	$L_V \cdot T \cdot \Delta uv$ <div style="border: 1px solid black; padding: 5px; margin-top: 5px;"> CH00:<DEFAULT> <ANGL> 1 VIEW <SPD> AUTO <SYNC>200.00Hz <LENS>STANDARD <MEM>AUTO NUM <MEMORY DATA> M000:(NO DATA) Lv ----- T ----- Δuv ----- <MODE>SINGLE [] ● [2°] </div>	$\%L_V \cdot \Delta L_V \cdot \Delta T$ <div style="border: 1px solid black; padding: 5px; margin-top: 5px;"> CH00:<DEFAULT> <ANGL> 1 VIEW <SPD> AUTO <SYNC>200.00Hz <LENS>STANDARD <MEM>AUTO NUM <MEMORY DATA> M000:(NO DATA) %Lv ----- % ΔLv ----- cd/m² ΔT ----- K <MODE>SINGLE [] ● [2°] </div>	
XYZ	$X \cdot Y \cdot Z$ <div style="border: 1px solid black; padding: 5px; margin-top: 5px;"> CH00:<DEFAULT> <ANGL> 1 VIEW <SPD> AUTO <SYNC>200.00Hz <LENS>STANDARD <MEM>AUTO NUM <MEMORY DATA> M000:(NO DATA) X ----- Y ----- Z ----- <MODE>SINGLE [] ● [2°] </div>	$\Delta X \cdot \Delta Y \cdot \Delta Z$ <div style="border: 1px solid black; padding: 5px; margin-top: 5px;"> CH00:<DEFAULT> <ANGL> 1 VIEW <SPD> AUTO <SYNC>200.00Hz <LENS>STANDARD <MEM>AUTO NUM <MEMORY DATA> M000:(NO DATA) ΔX ----- ΔY ----- ΔZ ----- <MODE>SINGLE [] ● [2°] </div>	$\%X \cdot \%Y \cdot \%Z$ <div style="border: 1px solid black; padding: 5px; margin-top: 5px;"> CH00:<DEFAULT> <ANGL> 1 VIEW <SPD> AUTO <SYNC>200.00Hz <LENS>STANDARD <MEM>AUTO NUM <MEMORY DATA> M000:(NO DATA) %X ----- % %Y ----- % %Z ----- % <MODE>SINGLE [] ● [2°] </div>
Dominant wavelength	λd <div style="border: 1px solid black; padding: 5px; margin-top: 5px;"> CH00:<DEFAULT> <ANGL> 1 VIEW <SPD> AUTO <SYNC>200.00Hz <LENS>STANDARD <MEM>AUTO NUM <MEMORY DATA> M000:(NO DATA) λd ----- nm Δd ----- <MODE>SINGLE [] ● [2°] </div>	$\Delta \lambda d$ *3 <div style="border: 1px solid black; padding: 5px; margin-top: 5px;"> CH00:<DEFAULT> <ANGL> 1 VIEW <SPD> AUTO <SYNC>200.00Hz <LENS>STANDARD <MEM>AUTO NUM <MEMORY DATA> M000:(NO DATA) Δλd ----- nm <MODE>SINGLE [] ● [2°] </div>	

*1 Y is displayed instead of Lv when observer angle is 10°.

*2 Not displayed when observer angle is 10°.

*3 Even if either the measured value, target color, or both are the complementary wavelength, the difference between the two values will be displayed. Further, even in such case, the display indication will remain $\Delta \lambda d$.

Operation Procedure

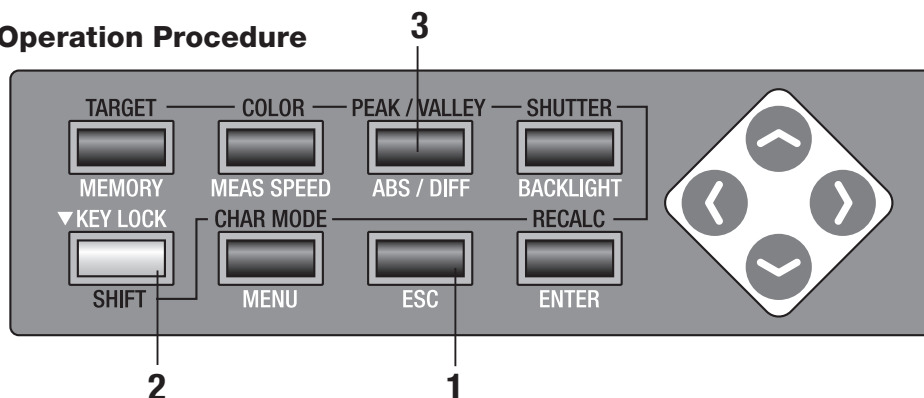

1. Press **ESC** key when menu or target value setting menu appears.
Measurement screen appears on LCD screen.

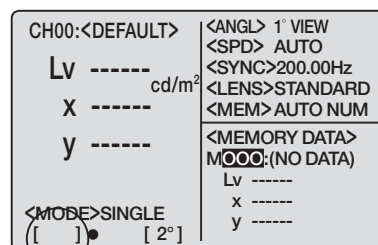

2. Make sure that [] appears on left bottom indicating this instrument has not been set for **SHIFT** mode.

If [**SFT**] appears instead, it means that instrument is to operate in SHIFT mode. Press **SHIFT** key to cancel SHIFT mode.

3. Press **ABS/DIFF** key to show absolute value (**ABS**) or color difference (**DIFF**) to select.

Measurement value switches between that for absolute value (ABS) and difference while pressing key.

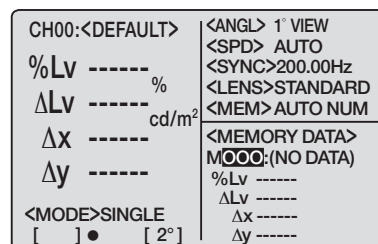

Setting remains even after switching OFF (O).

Selecting Digit for Chromaticity Display

This is selectable either 4 or 3.

If measurement value on LCD screen is illegible because of blinking, set for 3 digits.

* Setting at the shipment from factory : 4 FIGURES

Operation Procedure

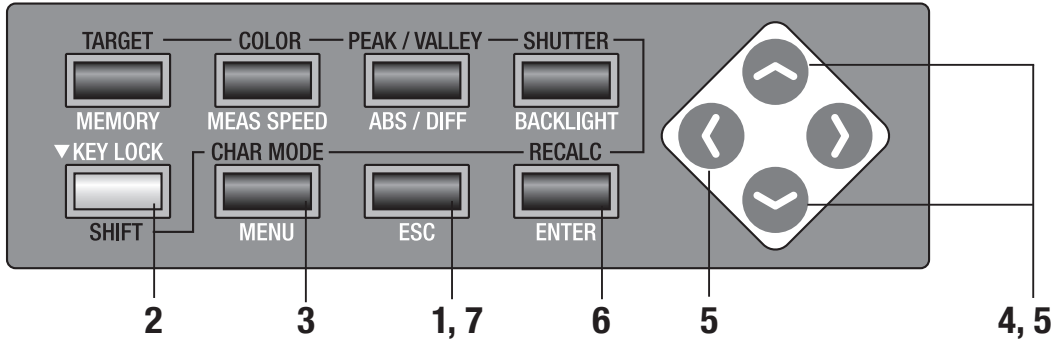

1. Press **ESC** key when menu or target value setting menu appears.
Measurement screen appears on LCD screen.

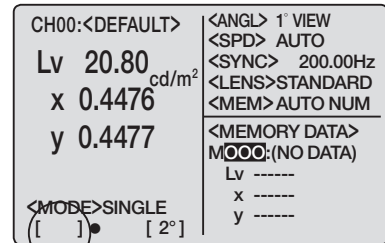



2. Make sure that [] appears on left bottom indicating this instrument has not been set for **SHIFT** mode.

If [SFT] appears instead, it means that instrument is to operate in SHIFT mode. Press **SHIFT** key to cancel SHIFT mode.

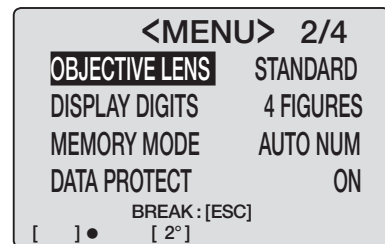
3. Press **MENU** key twice.
Menu 2/4 screen appears on LCD screen.



4. Press either  or  key to select **[DISPLAY DIGITS]** and then **ENTER** key.
Inversion cursor moves from **[DISPLAY DIGITS]** to right to change digits to display.

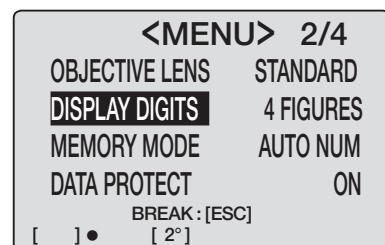

5. Press either  or  key to set for either [4 FIGURES] or [3 FIGURES].

Press **ESC** key to stop.

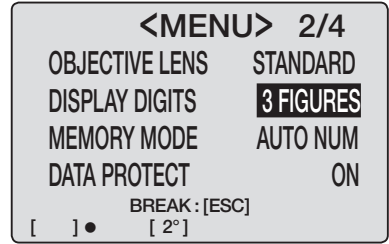

6. Press **ENTER key.**

Inversion cursor returns to **[DISPLAY DIGITS]**. Now change has been set.

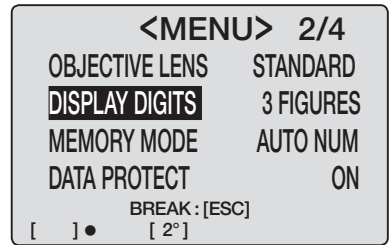

7. Press **ESC key to return to measurement screen.**

Setting remains even after switching OFF (O).

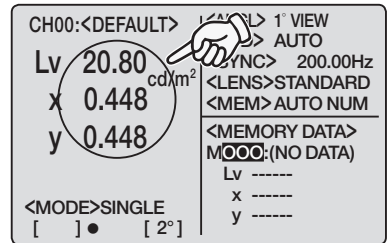

Selecting Lens Type

Use optional accessory close-up lens for small area measurement. See instruction manual for close-up lens for the placement of one. If close-up lens is to use, measurement value is required for calibration of lens transmission factor. Since calibration value varies depending on lens type, lens type has to be set in this instrument in advance. Erroneous setting causes incorrect measurement. Below table shows lens to set and setting for this instrument.

Lens to Set	No lens	Close-Up lens No.107	Close-Up lens No.122	Arbitrary lens like optional accessory ND filter (1/10) CS-A6, ND Filter (1/100) CS-A7, Combination of close-up lens and ND filter		
Setting	STANDARD	No.107	No.122	USER1*	USER2*	USER3*

- * Setting at the shipment from factory : STANDARD
- * Use standard accessory data management software CS-S10w Standard or optional CS-S10w Professional to avail more lens type like USER1, USER2 and USER3, and register calibration value for lens other than close-up lens No.107 and No.122 set in USER1, USER2 or USER3. See instruction manual for data management software for details.

Operation Procedure

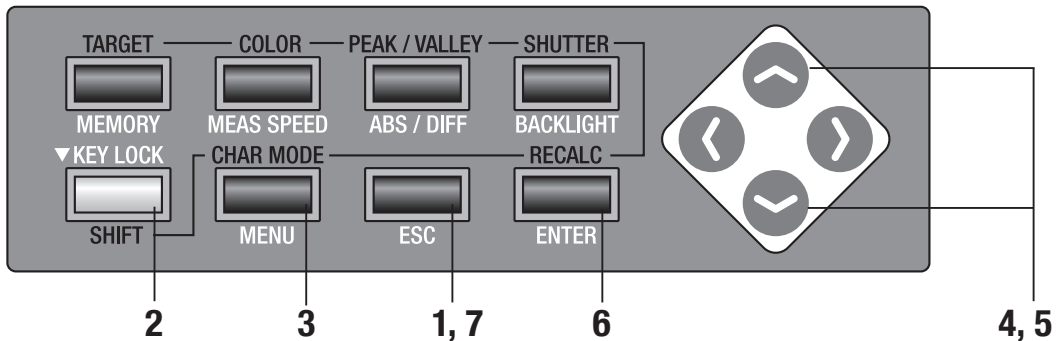

1. Press **ESC** key when menu or target value setting menu appears.
Measurement screen appears on LCD screen.

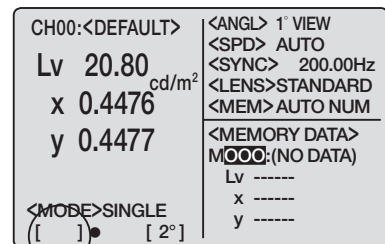

2. Make sure that [] appears on left bottom indicating this instrument has not been set for SHIFT mode.

If [SFT] appears instead, it means that instrument is to operate in SHIFT mode. Press **SHIFT** key to cancel SHIFT mode.

3. Press **MENU** key twice.

Menu 2/4 screen appears on LCD screen.

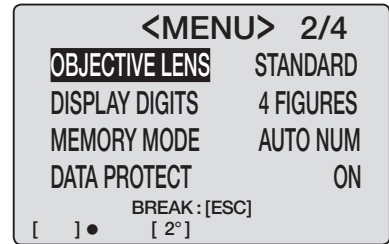

4. Press either **▲** or **▼** key to select **[OBJECTIVE LENS]** and then **ENTER** key.

Inversion cursor moves from **[OBJECTIVE LENS]** to right to change lens type.

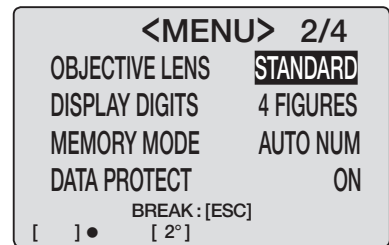

5. Press either **▲** or **▼** key to switch lens type.

If **▲** is pressed, lens type switches in order of [STANDARD] → [No.122] → [No.107] → [STANDARD]. Keep pressing to continuously switch.

If **▼** is pressed, lens type switches in order of [STANDARD] → [No.107] → [No.122] → [STANDARD]. Keep pressing to continuously switch.

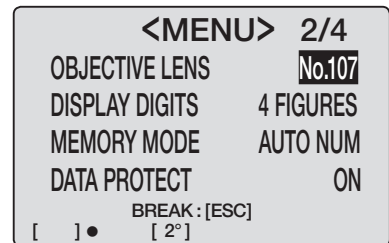

Set to [No.107] for close-up lens No.107, [No.122] for close-up lens No.122 and [STANDARD] for nothing with objective lens.

Press **ESC** key to stop.

6. Press **ENTER** key.

Inversion cursor returns to **[OBJECTIVE LENS]**. Now change has been set.

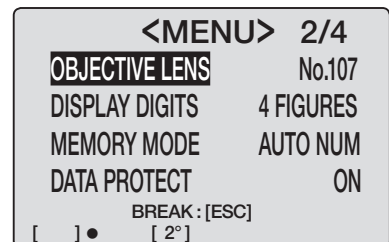

7. Press **ESC** key to return to measurement screen.

Setting remains even after switching OFF (O).

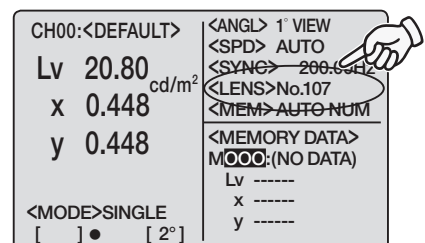

Selecting Single or Continuous Measurement

Here, measurement mode is selectable between “Single measurement” and “Continuous measurement”. Former means one measurement for one press and the latter continuous measurement from one press to another press of any key. In case of “Continuous measurement”, you can also view max and min values during continuous measurement when measurement is completed.

* Setting at the shipment from factory : SINGLE

Operation Procedure

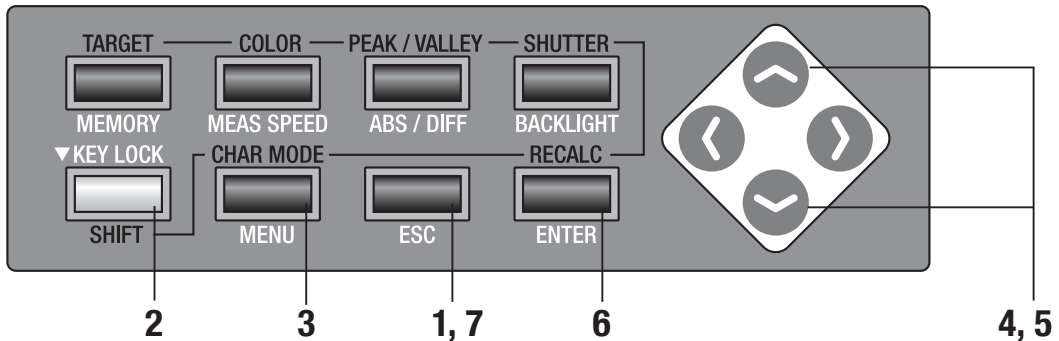

1. Press **ESC** key when menu or target value setting menu appears.
Measurement screen appears on LCD screen.

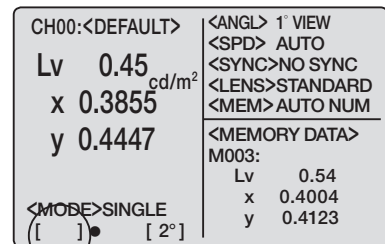

2. Make sure that [] appears on left bottom indicating this instrument has not been set for SHIFT mode.

If [SFT] appears instead, it means that instrument is to operate in SHIFT mode. Press **SHIFT** key to cancel SHIFT mode.

3. Press **MENU** key.
Menu 1/4 screen appears on LCD screen.

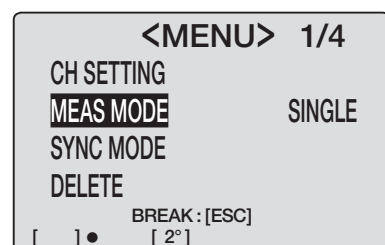

4. Press either  or  key to select [MEAS MODE] and then ENTER key.

Inversion cursor moves from [MEAS MODE] to right to change measurement mode.

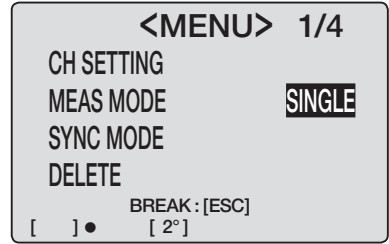

5. Press either  or  key to set for [SINGLE] or [CONT.].

Press ESC key to stop.

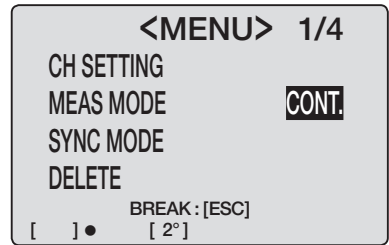

6. Press either ENTER key.

Inversion cursor returns to [MEAS MODE]. Now change has been set.

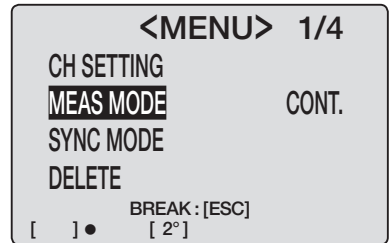

7. Press ESC key to return to measurement screen.

Measurement is made only once when user calibration and target color measurement are done even though [CONT.] has been set. In case of measuring max and min values, continuous measurement is made even though [SINGLE] has been set.

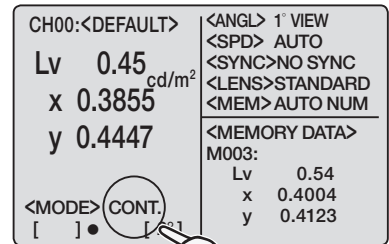

Setting remains even after switching OFF (O).

Selecting of Max or Minimum Value Display

Measurement result display is selectable among latest, max and minimum. If max <PEAK> or minimum <VALLEY> has been selected here, continuous measurement is to perform even though single measurement has been set. Lv determines max and min values.

* Setting at the shipment from factory : latest

Operation Procedure

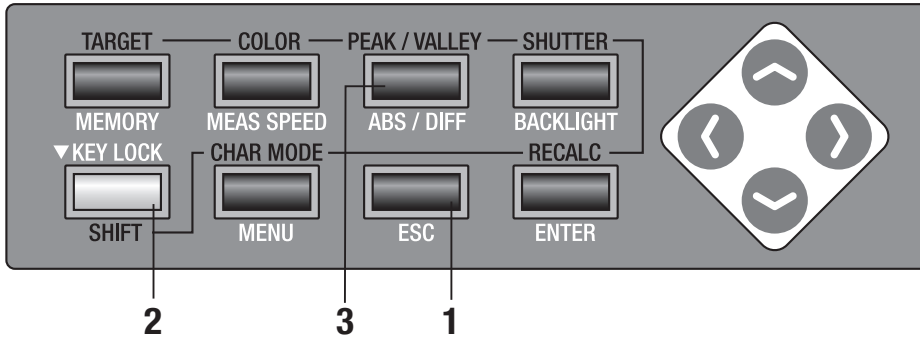

1. Press **ESC** key when menu or target value setting menu appears.

Measurement screen appears on LCD screen.

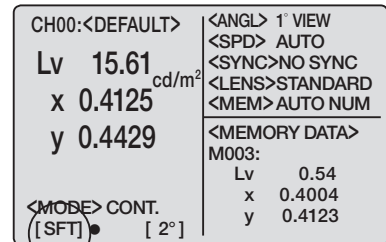

2. Make sure that [] appears on left bottom indicating this instrument has not been set for **SHIFT** mode.

If **[SFT]** appears instead, it means that instrument is to operate in SHIFT mode. Press **SHIFT** key to cancel SHIFT mode.

3. Press **PEAK/VALLEY** key to show measurement mode to select.

Measurement screen switches in order of normal → <PEAK> → <VALLEY> → normal in SHIFT while pressing **PEAK/VALLEY** key.

Latest measurement value shall appear as result in normal, maximum in **<PEAK>**, and minimum in **<VALLEY>** for continuous measurement.

Latest measurement value also appears on LCD screen in case that **<PEAK>** or **<VALLEY>** has been selected.

Setting for normal screen/<PEAK>/<VALLEY> shall be retained even after switching OFF (O).

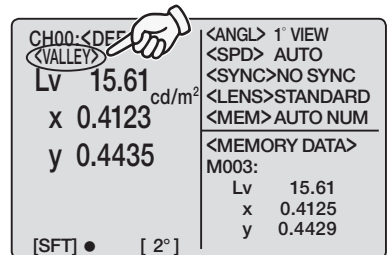
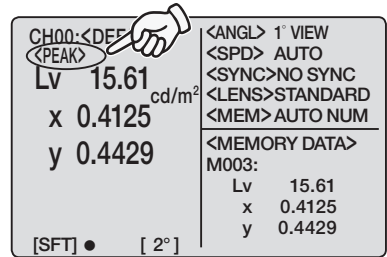
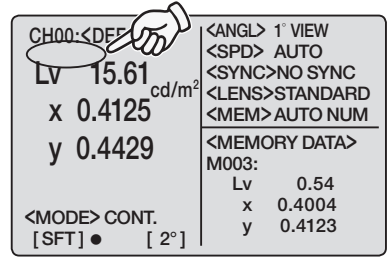

Opening and Closing of Finder Shutter

To prevent light from finder from badly influencing measurement, internal shutter of finder is to close for every measurement. If observation through finder during measurement is required, setting can be changed not to close finder shutter. In this case, light from finder needs to be avoided by looking into finder during measurement.

* Setting at the shipment from factory : ● (automatically closes for every measurement)

Operation Procedure

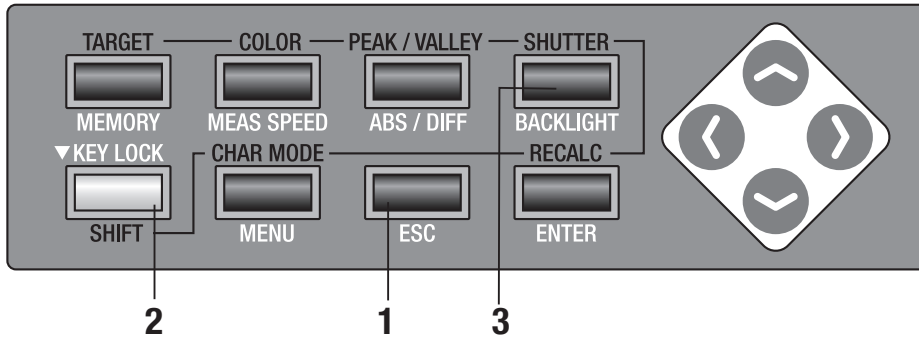

1. Press **ESC** key when menu or target value setting menu appears.
Measurement screen appears on LCD screen.

CH00:<DEFAULT>	<ANGL> 1° VIEW
Lv 92.74	<SPD> AUTO
x 0.4185	<SYNC>NO SYNC
y 0.4242	<LENS>STANDARD
	<MEM>AUTO NUM
	<MEMORY DATA>
	M003:
	Lv 1.04
	x 0.3772
	y 0.3663
<MODE> CONT.	
[SFT]	[2°]

2. Make sure that [] appears on left bottom indicating this instrument has not been set for **SHIFT** mode.

If [SFT] appears instead, it means that instrument is to operate in SHIFT mode. Press **SHIFT** key to cancel SHIFT mode.

3. Press SHUTTER key.

Icon [●] indicating "automatically closes for every measurement" switches to icon [○] meaning "always opens" in SHIFT mode.

Setting remains even after switching OFF (O).

CH00:<DEFAULT>	<ANGL> 1° VIEW
Lv 92.74 ^{cd/m²}	<SPD> AUTO
x 0.4185	<SYNC>NO SYNC
y 0.4242	<LENS>STANDARD
<MODE> CONT.	<MEM>AUTO NUM
[] ● [2°]	<MEMORY DATA>
	M003:
	Lv 1.04
	x 0.3772
	y 0.3663

CH00:<DEFAULT>	<ANGL> 1° VIEW
Lv 92.74 ^{cd/m²}	<SPD> AUTO
x 0.4185	<SYNC>NO SYNC
y 0.4242	<LENS>STANDARD
<MODE> CONT.	<MEM>AUTO NUM
[] ○ [2°]	<MEMORY DATA>
	M003:
	Lv 1.04
	x 0.3772
	y 0.3663

Setting of Stored Data Protection

Whether warning message appears or not is selectable for the case to store data in the memory channel with measurement value.

* Setting at the shipment from factory : ON

Operation Procedure

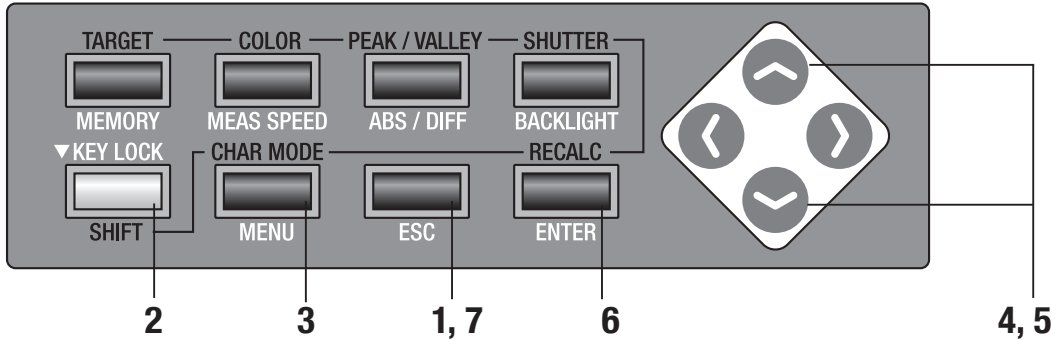

1. Press **ESC** key when menu or target value setting menu appears.

Measurement screen appears on LCD screen.

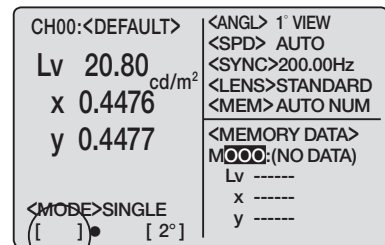

2. Make sure that [] appears on left bottom indicating this instrument has not been set for **SHIFT** mode.

If [SFT] appears instead, it means that instrument is to operate in SHIFT mode. Press **SHIFT** key to cancel SHIFT mode.

3. Press **MENU** key twice..

Menu 2/4 screen appears on LCD screen.

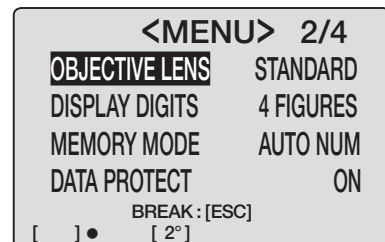

4. Press either  or  key to select **[DATA PROTECT]** and then **ENTER** key.

Inversion cursor moves from [DATA PROTECT] to right to change setting for data protection.

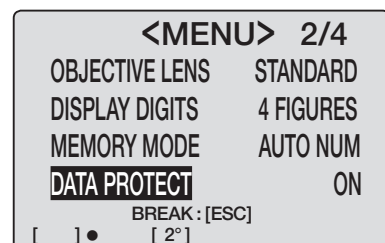

5. Press either \uparrow or \downarrow key to set for [ON] or [OFF].

If [ON] has been selected, a warning message "OK TO OVERWRITE?" appears when trying to store data to the directory with existing data .

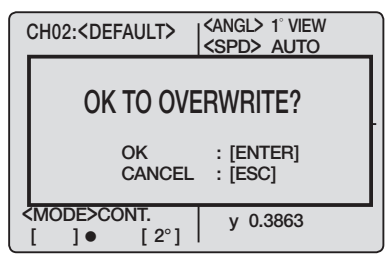

[OFF] proceeds with overwriting without warning message.

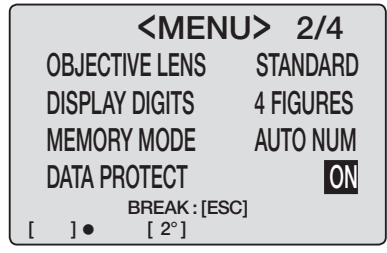

6. Press ENTER key.

Inversion cursor returns to [DATA PROTECT] to fix setting for data protection.

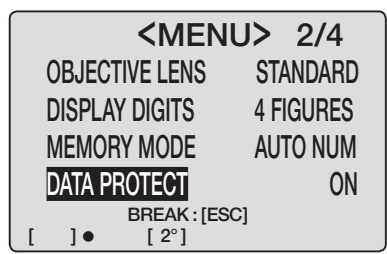

7. Press ESC key to return to measurement screen.

Setting remains even after switching OFF (O).

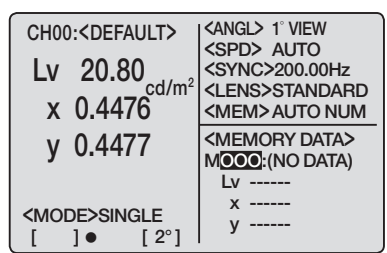

Setting of Update Method for Memory Channel to Store Measurement Value

There are 100 directories to store measurement value from M000 to M100 and each can store one value, therefore 101 in total.

Here, whether measurement value is to store automatically or by pressing **MEMORY** key is selectable for every measurement.

See p.50 for details on protection of stored data when data storage is to perform on memory channel with another measurement value.

* Setting at the shipment from factory : AUTO NUMM

Operation Procedure

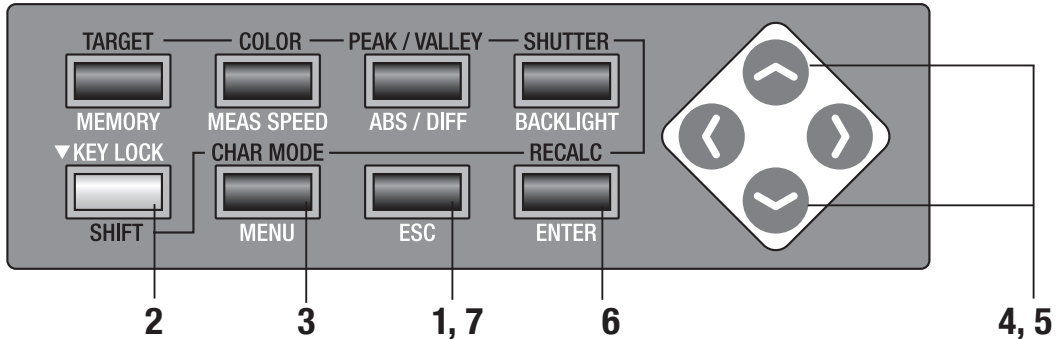

1. Press **ESC** key when menu or target value setting menu appears.
Measurement screen appears on LCD screen.

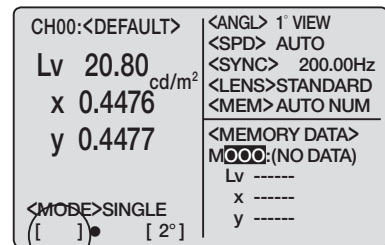

2. Make sure that [] appears on left bottom indicating this instrument is has not been set for **SHIFT** mode.

If [SFT] appears instead, it means that instrument is to operate in SHIFT mode. Press **SHIFT** key to cancel SHIFT mode.

3. Press [MENU] key twice.
Menu 2/4 screen appears on LCD screen.

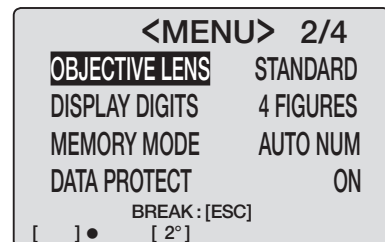

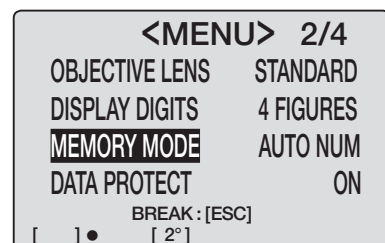

4. Press either or key to select [MEMORY MODE] and then **ENTER** key.

Inversion cursor moves from [MEMORY MODE] to right to change update method of memory channel.



5. Press either or key to switch update method of measurement value directory.

If  key is pressed, mode switches in order of [AUTO NUM] → [AUTOSAVE] → [MAN NUM] → [AUTO NUM]. If kept pressed, this switches continuously.
In case of  key, mode switches in reversing order. Keep pressing to switch continuously.

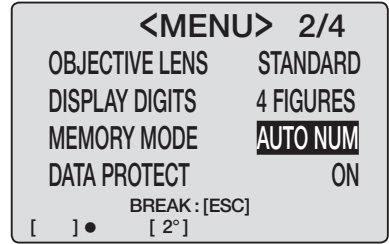

With [AUTO NUM] setting, memory channel number is replaced automatically after storing data by pressing **MEMORY** key. For example, if M005 is displayed, measurement value is to store in M005 after **MEMORY** key is pressed and number of memory channel displayed in **<MEMORY DATA>** is replaced to M006.

If [AUTOSAVE] is set, measurement value will be saved automatically after measurement and memory channel number changes accordingly. For example, if M005 is displayed, measurement value is to store in M005 after measurement is performed and number of memory channel displayed in **<MEMORY DATA>** is replaced to M006.

In case of [MAN NUM], measurement value is to store memory channel of which number is shown then. For example, if M005 is displayed, measurement value is to store in M005 and number of memory channel displayed in **<MEMORY DATA>** remains M005.

With [AUTO NUM] or [AUTOSAVE], and M100 has been used up, data goes back to M000 again.

When data storage is to perform on memory channel with another measurement value, a warning message appears.

Warning message "OK TO OVERWRITE?" appears. If OK, press **ENTER** key, and if not, **ESC** key.

Setting is available not to display such message. See p.50.

Press **ESC** key to stop.

6. Press **ENTER** key.

Inversion cursor returns to **[MEMORY MODE]**. Now change has been set.

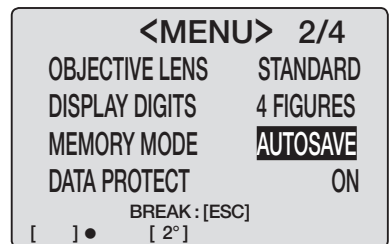

7. Press **ESC** key to return to measurement screen.

remains even after switching OFF (O).

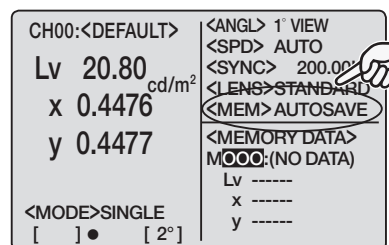

Buzzer Setting

This instrument usually generates buzzer sound for key operation, but setting for buzzer sound is switchable. Buzzer for measurement, operation, and error can be set independently.

* Setting at the shipment from factory : ON for MEASUREMENT, OPERATION, and WARNING

Operation Procedure

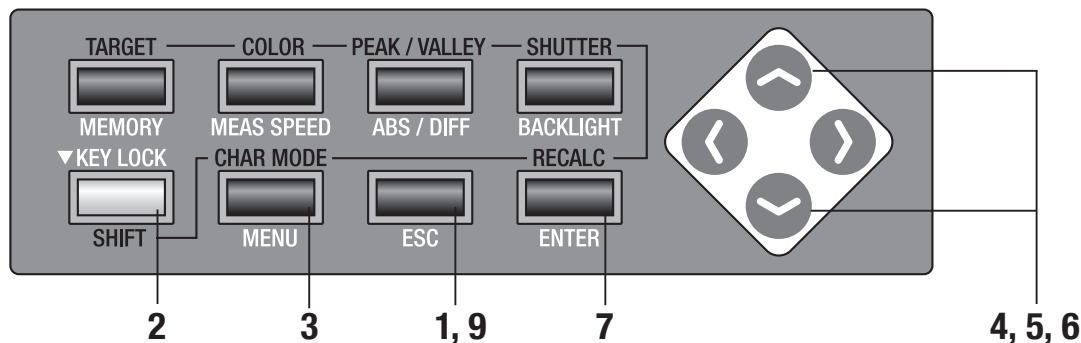

1. Press **ESC** key when menu or target value setting menu appears.

Measurement screen appears on LCD screen.

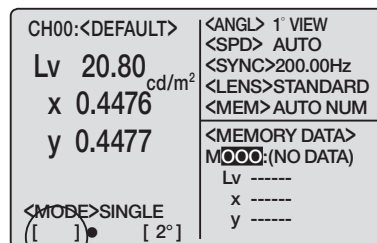

2. Make sure that [] appears on left bottom indicating this instrument has not been set for SHIFT mode.

If [SFT] appears instead, it means that instrument is to operate in SHIFT mode. Press **SHIFT** key to cancel SHIFT mode.

3. Press [MENU] key three times.

Menu 3/4 screen appears on LCD screen.

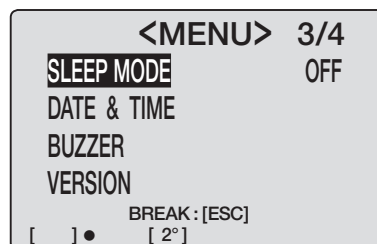

4. Press either  or  key to select [BUZZER] and then [ENTER] key.

<BUZZER> screen appears.

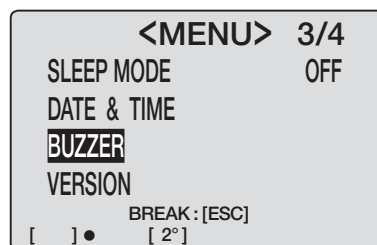

- 5. Press either \uparrow or \downarrow key to select parameter to change and then press ENTER key.**

Inversion cursor moves from parameter name to right to change setting for buzzer sound.

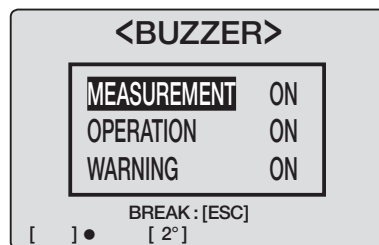

- 6. Press either \uparrow or \downarrow to set for either [ON] or [OFF].**

If [ON] is set for [MEASUREMENT], short blip sounds after measurement, for [OPERATION], short blip when measurement button or related key is pressed, and for [WARNING], repeated blip sounds for erroneous key operation or error message.

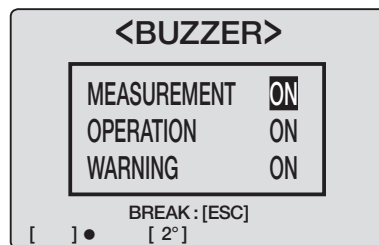

- 7. Press ENTER key.**

Inversion cursor returns to parameter name to fix setting for buzzer sound.

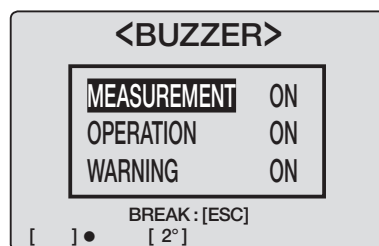

- 8. Repeat procedures 6. and 7. as necessary.**

- 9. Press ESC key twice to return to measurement screen.**

Setting remains even after switching OFF (O).

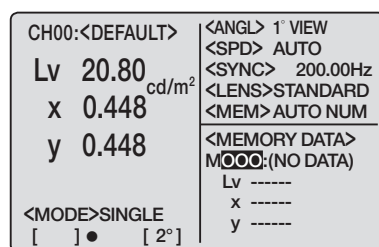

Backlight ON/OFF

Whether turning backlight on LCD is ON or OFF is selectable.

* Setting at the shipment from factory : ON

Operation Procedure

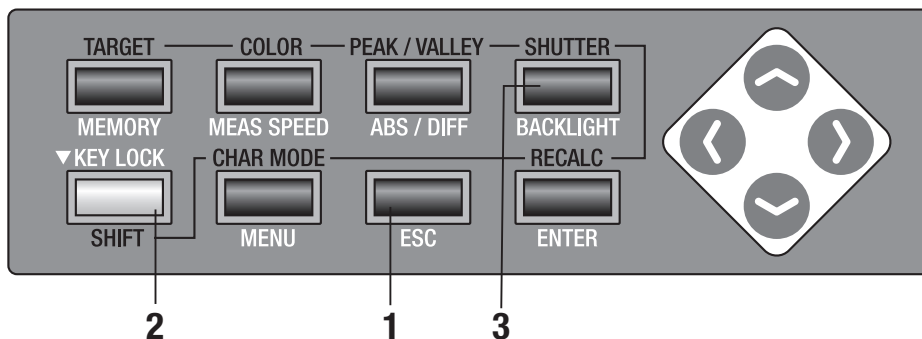

1. Press **ESC** key when menu or target value setting menu appears.

Measurement screen appears on LCD screen.

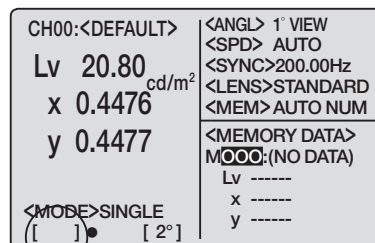

2. Make sure that [] appears on left bottom indicating this instrument has not been set for **SHIFT** mode.

If [**SFT**] appears instead, it means that instrument is to operate in SHIFT mode. Press **SHIFT** key to cancel SHIFT mode.

3. Press **BACKLIGHT** key.

If backlight has been on, it is switched off, and off, switched on.

Setting remains even after switching OFF (O).

Setting Sleep Mode

Sleep mode can be set for saving electric power consumption for the case that key has not been operated or communication has not been done for more than 30 minutes.

* Setting at the shipment from factory : OFF

Operation Procedure

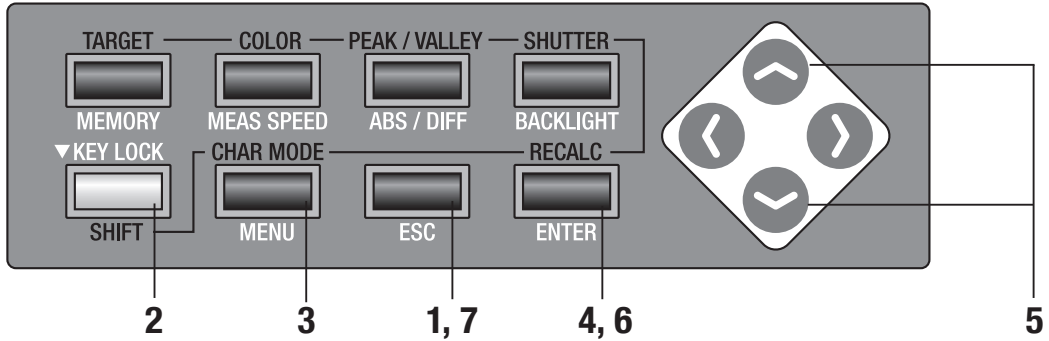

1. Press **ESC** key when menu or target value setting menu appears.
Measurement screen appears on LCD screen.

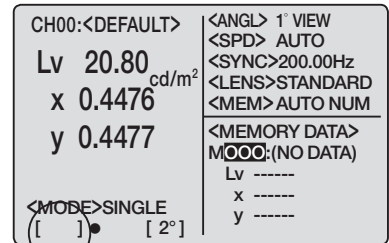

2. Make sure that [] appears on left bottom indicating this instrument has not been set for **SHIFT** mode.
If [SFT] appears instead, it means that instrument is to operate in SHIFT mode. Press **SHIFT** key to cancel SHIFT mode.

3. Press **MENU** key three times.
Menu 3/4 screen appears on LCD screen.

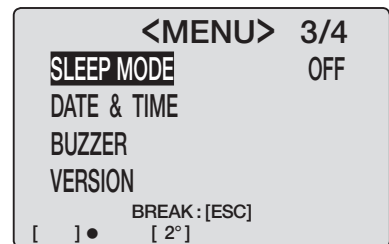

4. Press **ENTER** key.
Inversion cursor moves from [SLEEP MODE] to right to change setting for sleep mode.

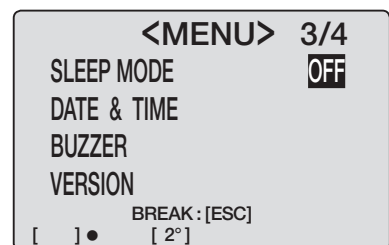

5. Press either  or  to set either for [ON] or [OFF].

If [ON] is set, this instrument operates in sleep mode when key operation or communication has not been done for more than 30 minutes. "SLEEP MODE" appears on LCD in sleep mode.

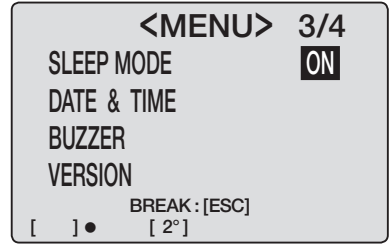

If measurement button or any key is pressed, original screen appears after "PLEASE WAIT".

When "PLEASE WAIT..." appears, do not switch OFF. Doing so may break stored data.

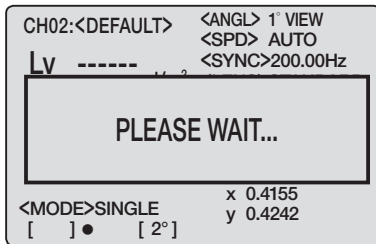

6. Press ENTER key.

Inversion cursor returns to [SLEEP MODE] to fix setting.

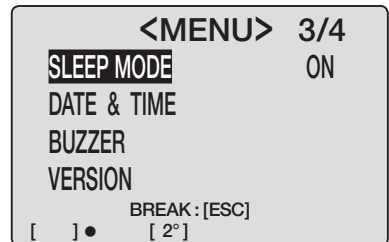

7. Press ESC key to return to measurement screen.

Setting remains even after switching OFF (O).

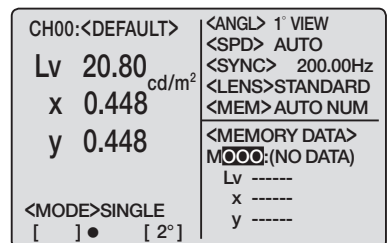

Setting Internal Clock

This instrument is equipped with internal clock to record measurement time. Although measurement date and time are not indicated in this instrument, one can be output together with measurement value when this unit is controlled with PC. If used with either standard accessory data management software CS-S10w Standard or optional CS-S10w Professional, measurement time is to display together with measurement value.

* Internal clock adjustment has been completed before shipment from factory.

Operation Procedure

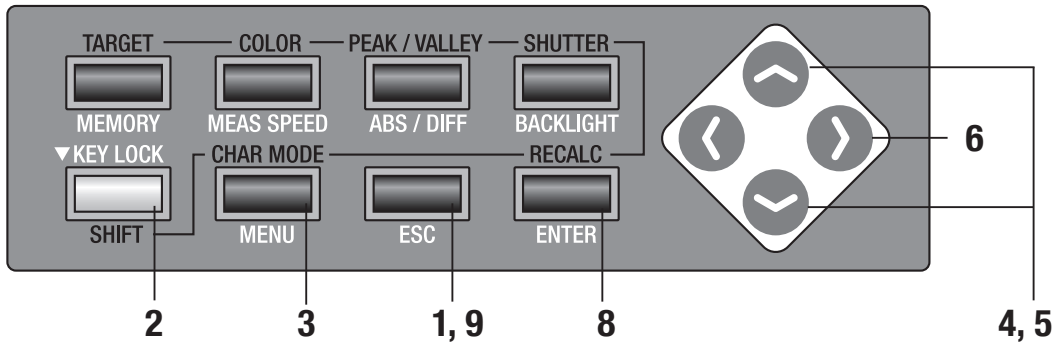

1. Press **ESC** key when menu or target value setting menu appears. Measurement screen appears on LCD screen.

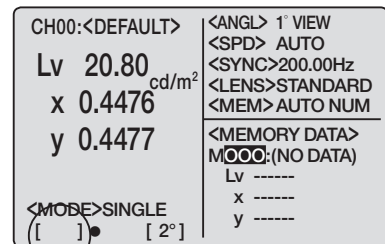



2. Make sure that [] appears on left bottom indicating this instrument has been set for **SHIFT** mode.



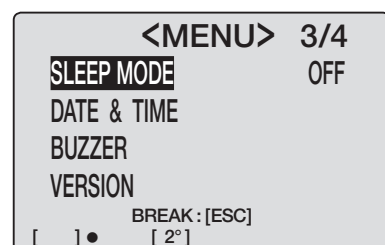

If [SFT] appears instead, it means that instrument is to operate in SHIFT mode. Press **SHIFT** key to cancel SHIFT mode.

3. Press **MENU** key three times. Menu 3/4 screen appears on LCD screen.

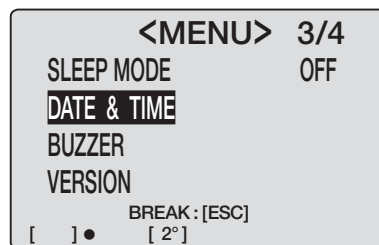

4. Press either  or  to select [DATE & TIME] and then **ENTER** key.
< DATE & TIME > screen appears.



5. Press either  or  to set arbitrary value.
 key for larger number. If kept pressed, value continuously increases.
 key for smaller number. If kept pressed, value continuously becomes small.

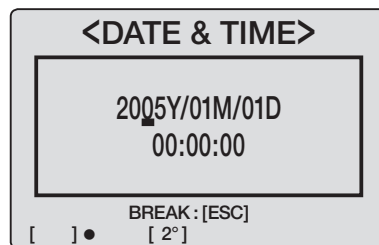

6. Press  key to move cursor to second digit position.
Cursor shall not move if unsettable number has been entered.

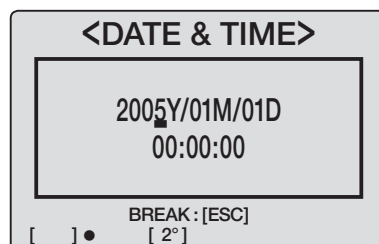

7. Repeat the procedures from 5. to 6. as necessary.
Year range available to set is 2000 to 2099. If you enter month and day that do not exist in calendar, error occurs. Time range available to set is 00:00:00 to 23:59:59. If you enter incorrect time, error occurs. Press **ESC** key to stop.

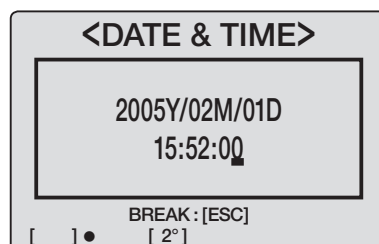

8. Press **[ENTER]** key.
Menu 3/4 screen appears on LCD screen indicating internal clock has been set.

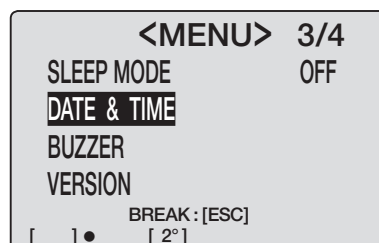

9. Press **ESC** key to return to measurement screen.

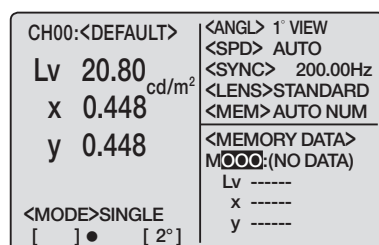

Measurement Preparation

Calibration

Calibration Channel



There are 21 calibration channels from CH00 to CH20.

Following settings are available for all channels.

- (1) Correction coefficient of user calibration
- (2) Target color
- (3) CH ID name

These are commonly used among each measurement mode of L_vxy , $L_vu'v'$, $L_vT\Delta uv$, XYZ, and dominant wavelength in one channel.

CH00 is for measurement based upon KONICA MINOLTA's calibration standard. Its calibration correction coefficient has been set and is unchangeable. Only target color and CH ID name settings are available.

To switch calibration channel, press either  or  key in SHIFT mode to switch one appearing on LCD screen.

CH ID name can be given to each channel through key operation. CH ID name is shown on LCD screen together with calibration channel.

User Calibration

User calibration indicates to set user's original correction coefficients in calibration channel by setting calibration value (For L_v , x , and y or L_v , u' and v' or X , Y and Z) in this instrument.

Displayed and output values for every measurement are values corrected with this correction coefficient unexceptionally.

Following calibration is available based on coefficient set by user.

- (1) Difference in instrument readings due to difference between CIE 1931 color-matching functions and spectral sensitivity.
- (2) Difference in instrument readings between units if multiple numbers of this unit are used.

This instrument employs monocalibration for user calibration. Accurate measurement can be performed at luminance and chromaticity around calibration light source.

- If you obtain calibration value by measuring a calibration light source with a prototype standard, set the prototype standard and CS-200 in the same position and angle as for the calibration light source and measure the same area. If measurement conditions with the prototype standard and with CS-200 are different, you fail to perform correct calibration.
- Keep calibration light source as stable as possible with fixed voltage power source during measurement.

User calibration can be applied to every channel except for CH00.

KONICA MINOLTA's correction coefficient has been set in all channels including CH00 by the time of shipment.

This shall restore if user calibration is reset.

Color on which user calibration is based is to set as target color in the same calibration channel.

Target color serves as reference to determine how measured color deviates from reference.

User calibration can be done through either of following methods.

- (1) Measurement
- (2) Select from stored data
- (3) Copy from other calibration channel

Implementing User Calibration

User calibration cannot be conducted in calibration channel CH00.

(CH00 serves as calibration channel for measurement based on KONICA MINOLTA's calibration standard.)

When user calibration is performed in the calibration channel for which target color has already been set, previous target color is cancelled.

These are commonly used among each color space of L_vxy , $L_vu'v'$, $L_vT\Delta uv$, XYZ, and dominant wavelength in one channel.

Operation Procedure

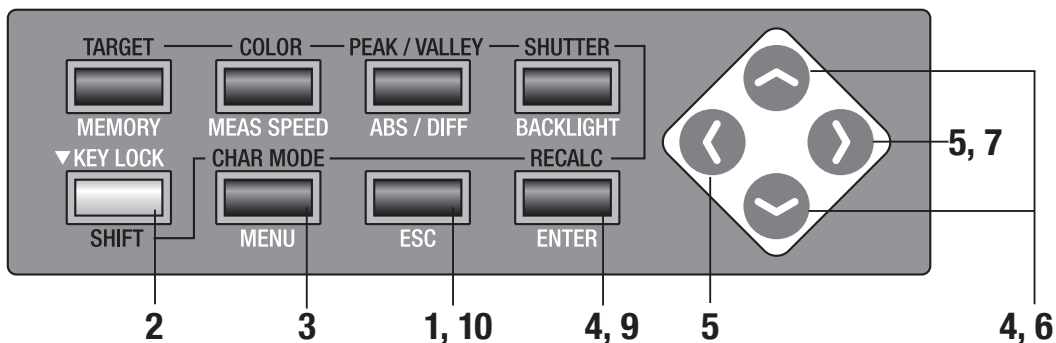

1. Press **ESC** key when menu or target value setting menu appears.

Measurement screen appears on LCD screen.

2. Press **SHIFT** key to switch to **SHIFT** mode.

[SFT] appears on left bottom indicating this instrument is to operate in SHIFT mode. Or make sure that [SFT] appears on left bottom indicating that this instrument has been operated in SHIFT mode.

3. Press either **↑** or **↓** key to switch calibration channel and select one for user calibration.

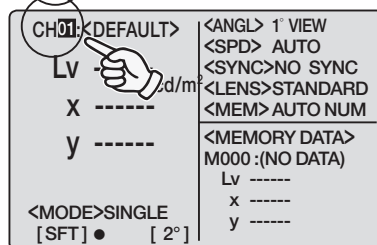
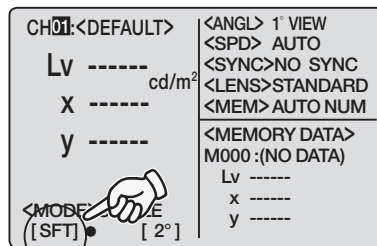

4. Press **SHIFT key to cancel **SHIFT** mode.**

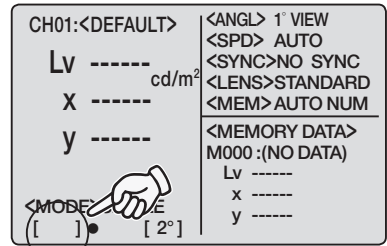

5. Press **MENU key.**

Menu 1/4 screen appears on LCD screen.

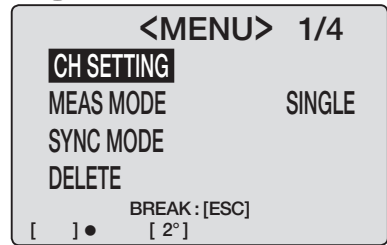

6. Press either  or  key to select **USER CAL and then **ENTER** key.**

< **USER CAL** > screen appears.

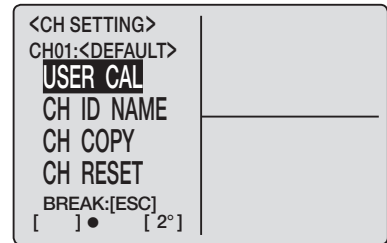

Continues to the following page.

- (1) Through measurement (p.66 to 67)
- (2) Through selection from saved data (p.68 to 69)
- (3) Copy from other calibration channel (p.70 to 71)

continuation from a p.64, 65.

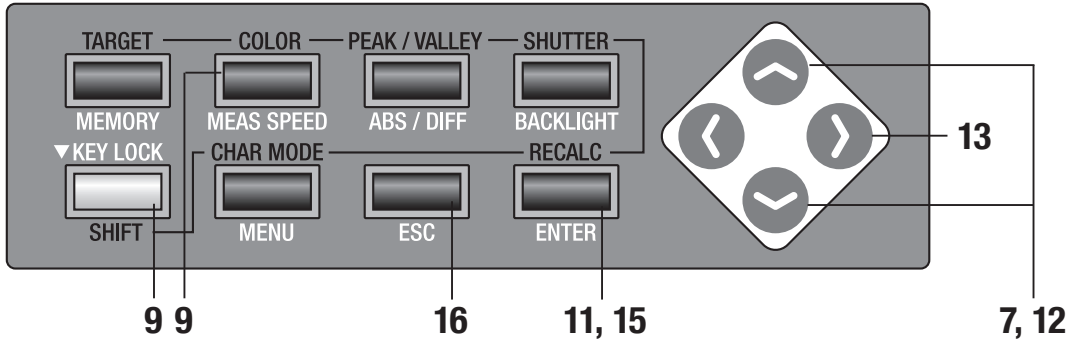

(1) Through measurement

- Press either or key to select **[USER CAL]** and then **ENTER** key. **< USER CAL DATA >** screen appears.

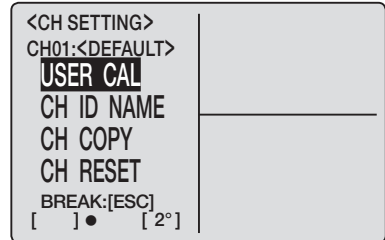

- Use close-up lens, select measuring angle, adjust finder diopter and focus.

For more details on each operation, see p.88.

Use light source of which luminance and chromaticity are known on object.

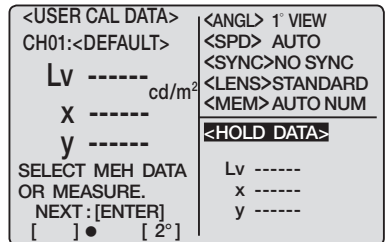

- Press **COLOR** key in **SHIFT** mode, and select color space.

Select same color space as calibration value to be entered in procedures from **12** to **13**.

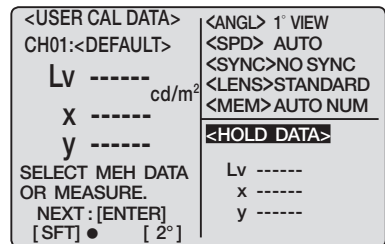

- Press measurement button to start measurement.

Now starts measurement.

This measurement is performed with correction coefficient (CH00) based upon KONICA MINOLTA's calibration standard.

Measurement value appears on **<CURRENT DATA>** part of LCD screen after measurement is completed.

After measurement, do not switch OFF until measurement value appears. Doing so may break stored data.

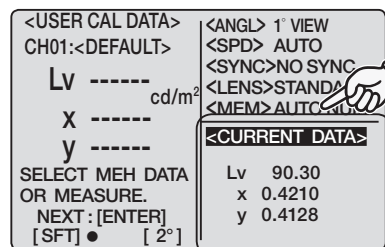

11. Press **ENTER** key.

Calibration entry screen appears.

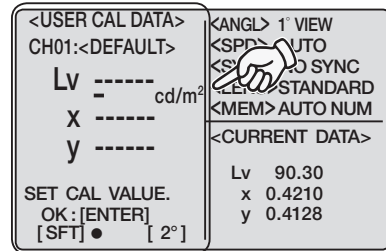

12. Enter value for calibration.

key: 0 to 9 in ascending order. K, M, decimal point and space available. If kept pressed, value continuously changes.

key: 9 to 0 descending order. K, M, decimal point and space available. If kept pressed, value continuously changes.

K and **M** show $\times 10^3$ and $\times 10^6$ respectively.

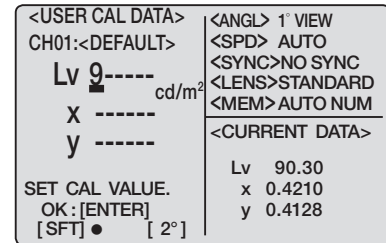

13. Press key to move cursor to second digit position.

(See p.71 for details on 'Numerical value entry ranges')

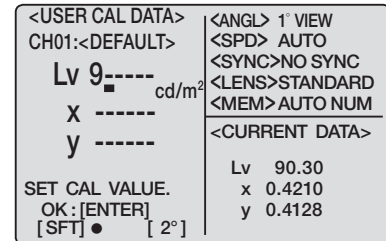

14. Repeat procedures from 12 to 13 as necessary to enter calibration values for Lv, x and y (or each value for other color spaces) respectively.

Press **ESC** key to stop.

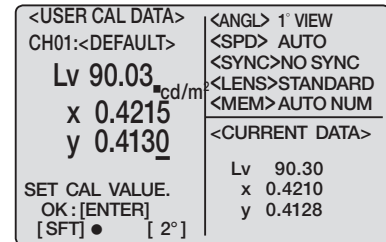

15. Press **ENTER** key.

After "**PLEASE WAIT...**" appears, **<CH SETTING>** screen appears.

When "**PLEASE WAIT...**" appears, do not

switch OFF. Doing so may break stored data.

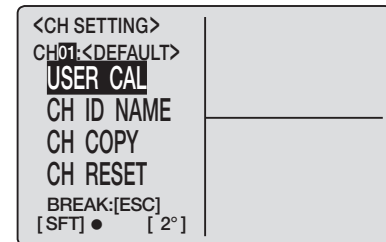

16. Press **ESC** key twice to return to measurement screen.

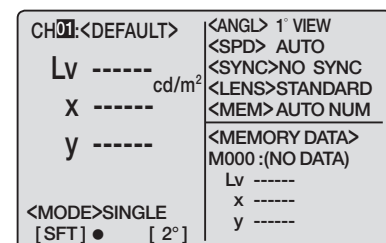

continuation from a p.64, 65.

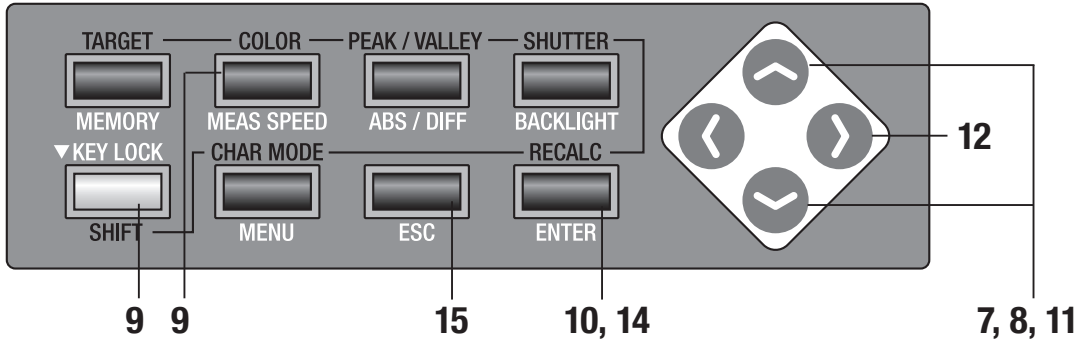

(2) Through selection from saved data

7. Press either or key to select **[USER CAL]** and then **ENTER** key.

< USER CAL DATA > screen appears.

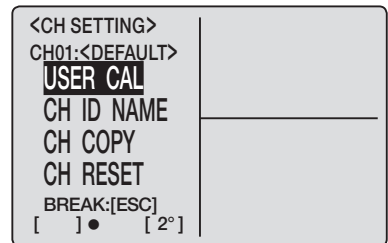

8. Press either or key to select stored data.

Please select data which was measured using CH00 (KONICA MINOLTA's calibration standard.)

The data are considered to have been calculated using CH00 (KONICA MINOLTA's calibration standard) without compensation coefficients for user calibration, even if data measured using a calibration channel other than CH00 are selected. Because of this, when existing data measured using a calibration channel other than CH00 are selected for performing user calibration, user calibration cannot be performed properly.

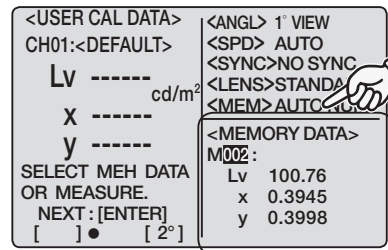

9. Press **COLOR** key in **SHIFT** mode, and select color space.

Select same color space as calibration value to be entered in procedures from 11 to 13.

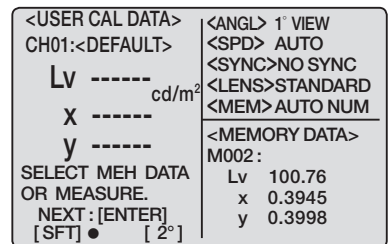

10. Press **ENTER** key.

Calibration entry screen appears.

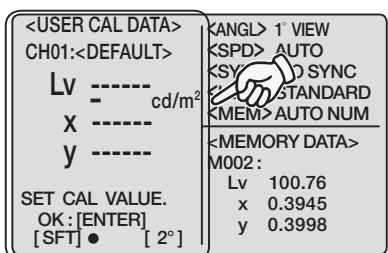

11. Enter value for calibration.

◀ key: 0 to 9 in ascending order. K, M, decimal point and space available. If kept pressed, value continuously changes.

▶ key: 9 to 0 descending order. K, M, decimal point and space available. If kept pressed, value continuously changes.

K and **M** show $\times 10^3$ and $\times 10^6$ respectively.
(See p.71 for details on 'Numerical value entry ranges')

<USER CAL DATA> CH01:<DEFAULT> Lv 1----- x ----- y ----- SET CAL VALUE. OK:[ENTER] [SFT] ● [2°]	<ANGL> 1° VIEW <SPD> AUTO <SYNC>NO SYNC <LENS>STANDARD <MEM>AUTO NUM <MEMORY DATA> M002: Lv 100.76 x 0.3945 y 0.3998
---	---

12. Press ▶ key to move cursor to second digit position.

<USER CAL DATA> CH01:<DEFAULT> Lv 1.----- x ----- y ----- SET CAL VALUE. OK:[ENTER] [SFT] ● [2°]	<ANGL> 1° VIEW <SPD> AUTO <SYNC>NO SYNC <LENS>STANDARD <MEM>AUTO NUM <MEMORY DATA> M002: Lv 100.76 x 0.3945 y 0.3998
--	---

13. Repeat procedures from 10 to 11 as necessary to enter calibration values for Lv, x, and y respectively.

Press **ESC** key to stop.

<USER CAL DATA> CH01:<DEFAULT> Lv 100.77 x 0.3945 y 0.4000 SET CAL VALUE. OK:[ENTER] [SFT] ● [2°]	<ANGL> 1° VIEW <SPD> AUTO <SYNC>NO SYNC <LENS>STANDARD <MEM>AUTO NUM <MEMORY DATA> M002: Lv 100.76 x 0.3945 y 0.3998
---	---

14. Press ENTER key.

After "PLEASE WAIT..." appears, <CH SETTING> screen appears.

When "PLEASE WAIT..." appears, do not switch OFF. Doing so may break stored data.

<CH SETTING> CH01:<DEFAULT> USER CAL CH ID NAME CH COPY CH RESET BREAK:[ESC] [SFT] ● [2°]	
--	--

15. Press ESC key twice to return to measurement screen.

CH01:<DEFAULT> Lv ----- x ----- y ----- <MODE>SINGLE [SFT] ● [2°]	<ANGL> 1° VIEW <SPD> AUTO <SYNC>NO SYNC <LENS>STANDARD <MEM>AUTO NUM <MEMORY DATA> M002: Lv 100.76 x 0.3945 y 0.3998
---	---

continuation from a p.64, 65.

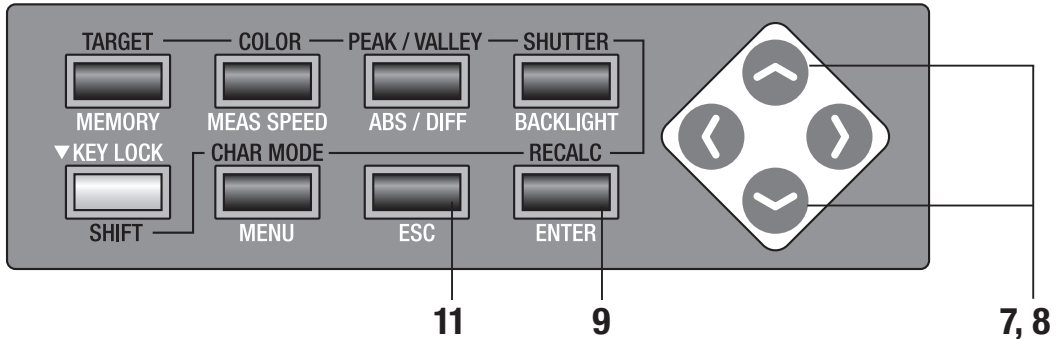

(3) Copy from other calibration channel

7. Press either or key to select [CH COPY] and then **ENTER** key.

< COPY TO ?? > screen appears.

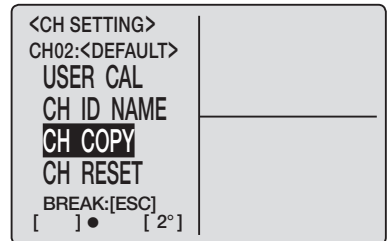

8. Press either or key to select calibration channel to copy from.

To change calibration channel to copy to, press **SHIFT** key to switch to SHIFT mode or press or key to select calibration channel to copy to.

Once copied, calibration channel to copy to cannot be returned to previous status before coping. Make sure to check channel number before copying.

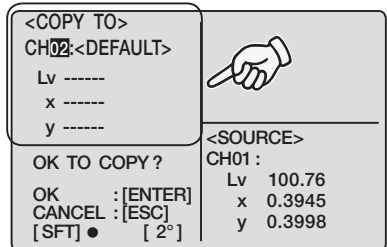
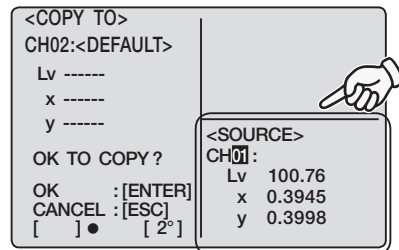

9. Press **ENTER** key.

After “**PLEASE WAIT...**” appears and the value is copied, <COPY TO> screen appears.

When “**PLEASE WAIT...**” appears, do not switch OFF. Doing so may break stored data.

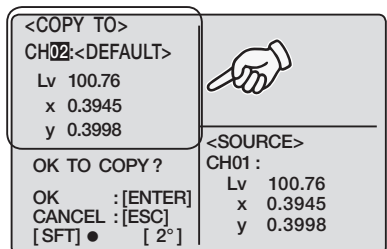

10. You can return to procedure 8 and continue copying other channel.

Note that original calibration channel appears when you return to measurement screen in procedure 11.

11. Press **ESC** key three times to return to measurement screen.

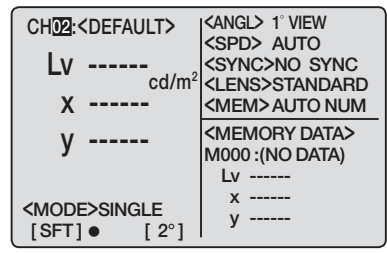

Numerical value entry ranges

- Numerical value entry ranges are shown below.
- All conditions should be satisfied.
 - 0 < x < 1, and
 - 0 < y < 1, and
 - 0 < x + y ≤ 1, and
 - 0 < X ≤ 99999000000, and
 - 0 < Y ≤ 99999000000, and
 - 0 ≤ Z ≤ 99999000000

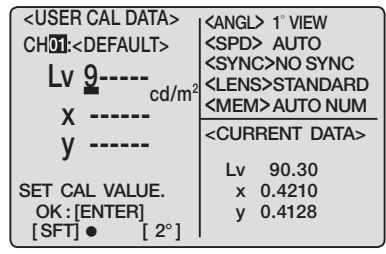

- Characters following K and M are ignored. ("1.0K3" is interpreted as "1.0K", i.e. 1000.)
- Characters following second decimal point are ignored. ("1.2.3" is interpreted as "1.2".)
- Characters following space between numbers are ignored. ("1.2_3" is interpreted as "12".)

Reset User Calibration

User calibration can be reset channel by channel. KONICA MINOLTA's calibration is to apply to channel for which user calibration has been reset. Also, target color and ID name settings in the channel are to delete.

Operation Procedure

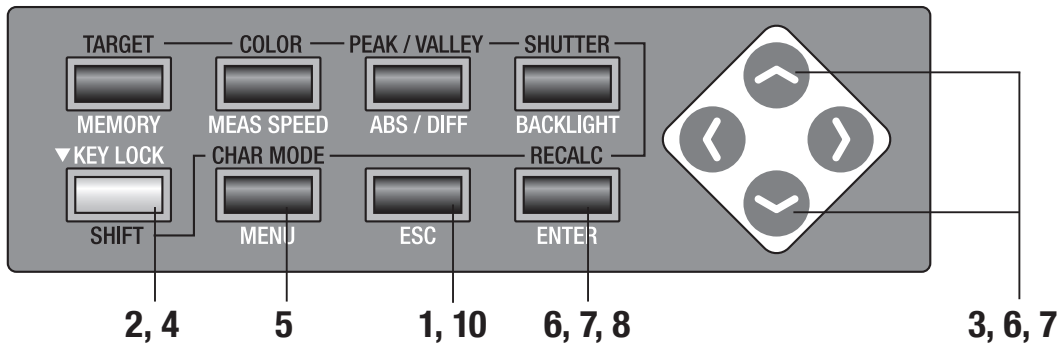

1. Press **ESC** key when menu or target value setting menu appears.

Measurement screen appears on LCD screen.

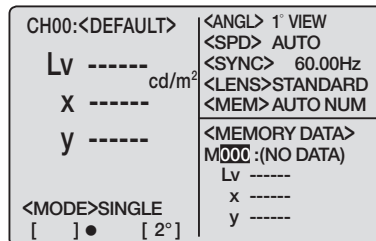

2. Press **SHIFT** key to switch to **SHIFT** mode.

[SFT] appears on left bottom. Or make sure that [SFT] appears on left bottom indicating that this instrument has been operated in SHIFT mode.

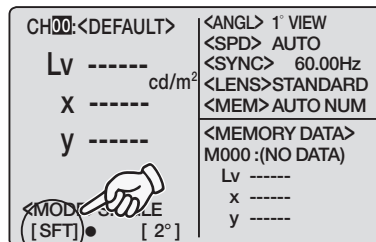

3. Press either **↑** or **↓** key to switch calibration channel and select one for which user calibration is to reset.

Once reset, calibration channel to copy to cannot be returned to previous status before resetting. Make sure to check channel number before copying.

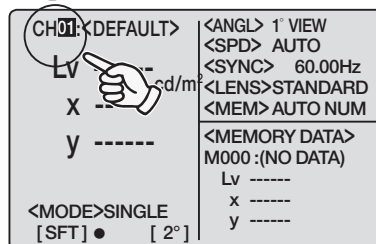

4. Press **SHIFT** key to cancel **SHIFT** mode.

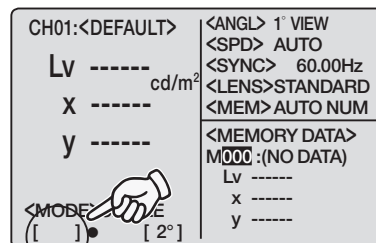

5. Press MENU key.

Menu 1/4 screen appears on LCD screen.

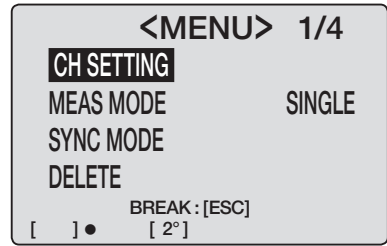

6. Press either or key to select <CH SETTING> and then ENTER key. < CH SETTING> screen appears.

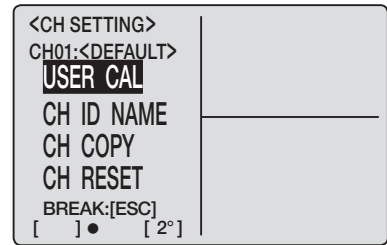

7. Press either or key to select [CH RESET] and then ENTER key. < RESET > screen appears.

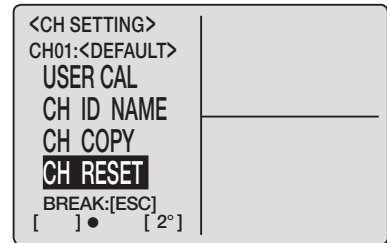

8. Press ENTER key.

After “PLEASE WAIT...” appears and it is reset, <RESET> screen appears.

When “PLEASE WAIT...” appears, do not switch OFF. Doing so may break stored data.

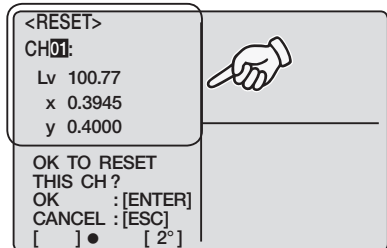

9. As in procedure 3, you can switch calibration channel to continue to reset other calibration channel.

Note that original calibration channel appears when you return to measurement screen in procedure 10.

10. Press ESC key three times to return to measurement screen.

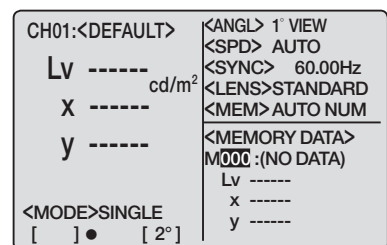

Setting CH ID Name

CH ID name indicates name given to each calibration channel by entering characters. CH ID name appears on LCD screen in measurement together with calibration channel. It is helpful if for which object user calibration or target color setting has been done is entered.

- Available number of characters for entry: 9 max
- Available character type for entry: A to Z, a to z, space, 0 to 9, symbol

Operation Procedure

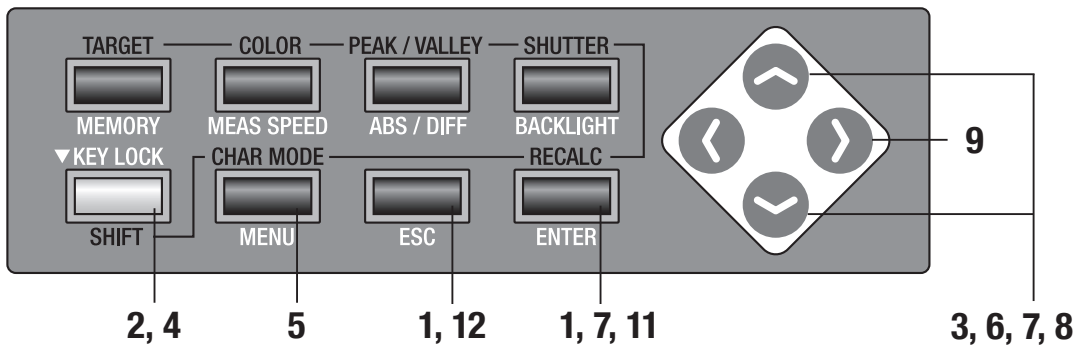

1. Press **ESC** key when menu or target value setting menu appears.

Measurement screen appears on LCD screen.

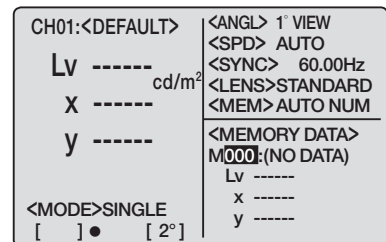

2. Press **SHIFT** key to switch to **SHIFT** mode.

[SFT] appears on left bottom. Or make sure that [SFT] appears on left bottom indicating that this instrument has been operated in SHIFT mode.

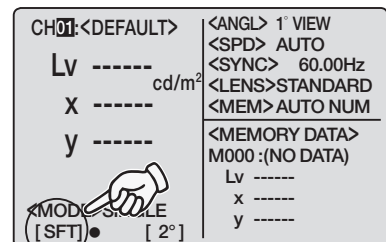

3. Press either **↑** or **↓** key to switch calibration channel and select one for CH ID name setting.

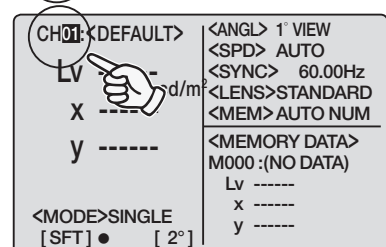

4. Press **SHIFT key to cancel **SHIFT** mode.**

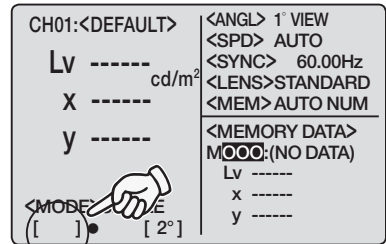

5. Press **MENU key.**

Menu 1/4 screen appears on LCD screen.

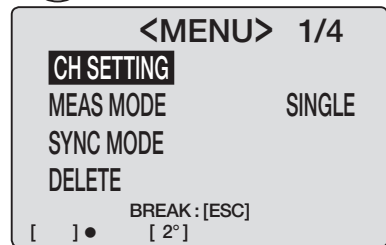

6. Press either **▲ or **▼** key to select **[CH SETTING]** and then **ENTER** key.**

< CH SETTING > screen appears.

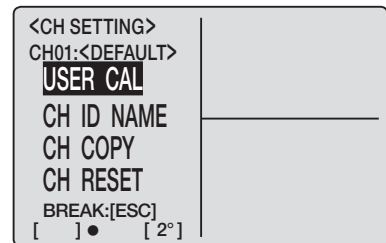

7. Press either **▲ or **▼** key to select **[CH ID NAME]** and then **ENTER** key.**

< CH ID NAME > screen appears.

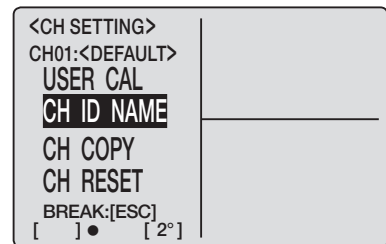

8. Enter CH ID name.

▲ : A to Z in descending order and space. If kept pressed, character switches continuously.

▼ : Z to A in ascending order and space. If kept pressed, character switches continuously.

Small alphabets, numerical values, and symbols are also available. See p.77 for details.

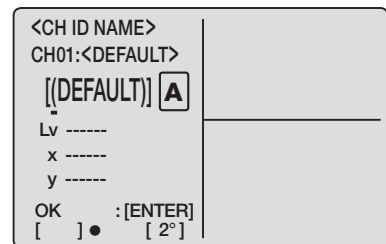

9. Press  key to move cursor to second digit position.

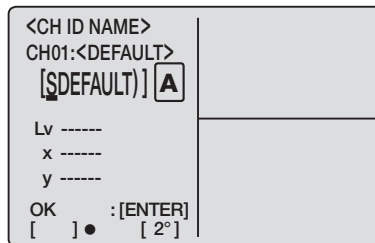

10. Repeat procedures from 8. to 9. as necessary.

Press **ESC** key to stop.

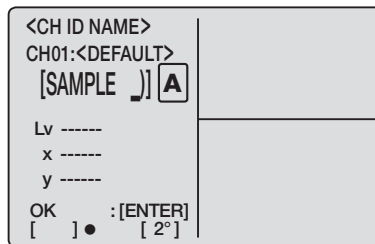

11. Press **ENTER** key.

After “PLEASE WAIT...” appears and it is reset, <CH SETTING> screen appears.

When “PLEASE WAIT...” appears, do not switch OFF. Doing so may break stored data.

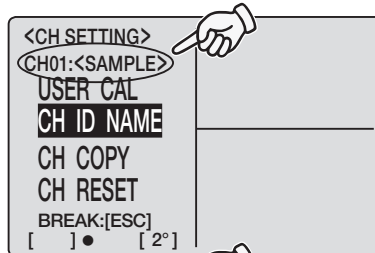

12. Press **ESC** key two times to return to measurement screen.

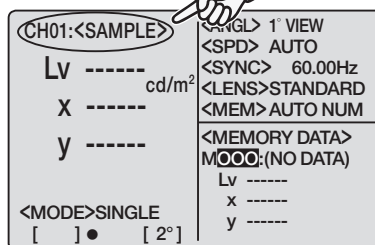

Entering Character

If you press **SHIFT** key to switch to SHIFT mode and then **CHAR MODD** key when screen to enter calibration channel ID and measurement value ID of stored data in appears, available character type for entry shifts in order of **Capital Alphabet** → **Small Alphabet** → **Numerical** → **Symbol**.

Either **A**, **a**, **1**, or **#** appears on the right of character entry area, depending on character type.

Characters available to enter Mark

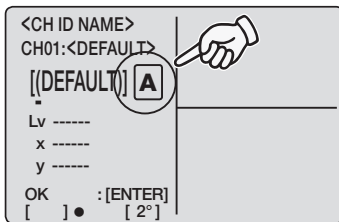

Capital Alphabet

A to Z, Space

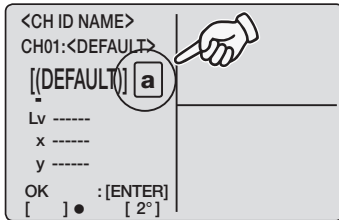

Small Alphabet

a to z, Space

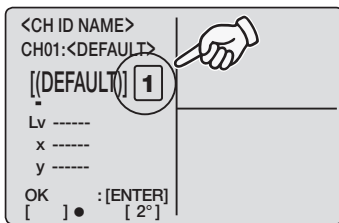

Numerical

0 to 9

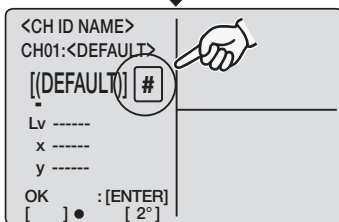

Symbol

Space ! " # \$ % & ' () * + , - . / : ;
< = > ? @ [] ^ _ ' { | }

Setting and Changing Target Color

Target color

Target color serves as reference for measurement of deviation of measured color from reference. It can be set channel by channel. Setting methods are as follows:

- (1) User calibration: Calibration value is simultaneously set as target color in user calibration.
- (2) Measurement
- (3) Select from stored data
- (4) Enter numerical value

Previously set target color is to erase since target color setting is performed at the same time as entry of user calibration correction coefficient.

Previously set target color should be replaced with and changed to another one to change. User calibration correction coefficient shall not be influenced despite of target color change.

Target color is commonly used among each measurement mode of Lv_{xy} , $Lv_u'v'$, $Lv_T(d)_{uv}$, XYZ, and dominant wavelength in one calibration channel.

No target color has been set for calibration channel without target color set by the time of shipment from factory. Only “-----” appears.

In the target setting screen, the target data for a channel other than the displayed channel may be displayed. If this occurs, use the up/down keys to temporarily select a different channel, and then return to the desired channel. The correct data will then be displayed.

When the display is switched repeatedly between the <TARGET> screen and <USER CAL DATA> screen while checking data, the target data shown in the <TARGET> screen may be the data for a different target channel than the channel number which is shown. For example, if the channel is set to CH01 in the <TARGET> screen, and then the screen is changed to the <USER CAL DATA> screen and CH02 is selected, and then the screen is changed back to the <TARGET> screen, the channel display continues to show CH02 but the displayed data are actually the data for CH01.

(1) Through user calibration

Calibration value is simultaneously set as target color if user calibration is performed in calibration channel from CH01 to CH20. No further target color setting is needed if target color has been fixed for calibration channel.

Follow below next page only when target color set in CH01 to CH20 needs to change or target color is needed to set in KONICA MINOLTA's calibration standard CH00.

(2) Through measurement

Operation Procedure

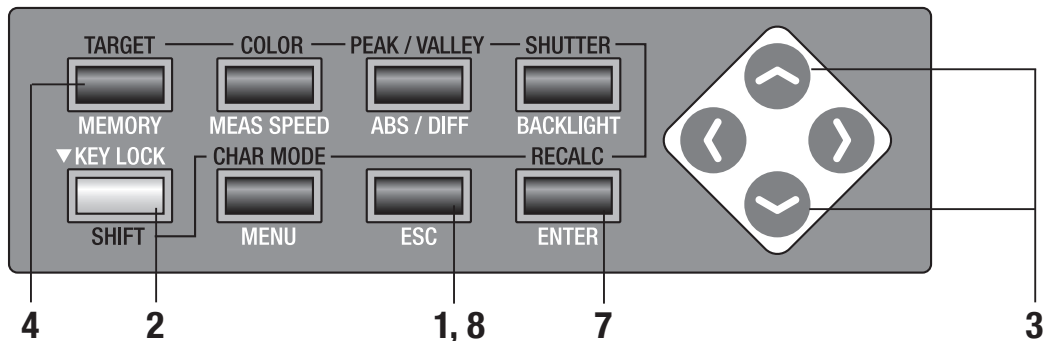

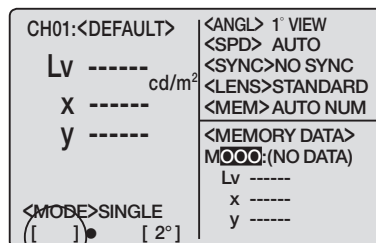

1. Press **ESC** key when menu or target value setting menu appears.

Measurement screen appears on LCD screen.



2. Press **SHIFT** key to switch to **SHIFT** mode.

[SFT] appears on left bottom. Or make sure that [SFT] appears on left bottom indicating that this instrument has been operated in SHIFT mode.

3. Press either  or  key to switch calibration channel and select one for which target color is to set.

Once target color is set, calibration channel cannot be returned to previous status before setting. Make sure to check channel number before overwriting.

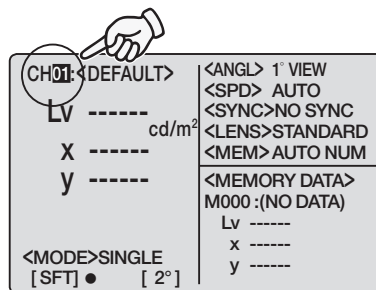

4. Press **TARGET** key.

<TARGET> screen appears.

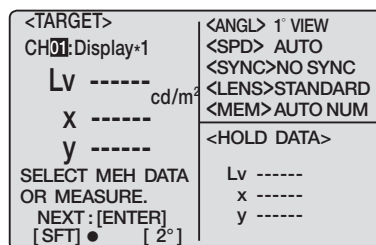

5. Use close-up lens, select measuring angle, adjust finder diopter and focus.

For more details on each operation, see p.88.

6. Press Measurement button to start measurement.

Now starts measurement.

Measurement value appears on **<HOLD DATA>** of LCD after measurement is completed.

After measurement, do not switch OFF until measurement value appears. Doing so may break stored data.

This measurement is corrected with user calibration value for selected calibration channel.

<TARGET>	<ANGL> 1° VIEW
CH01:Display*1	<SPD> AUTO
Lv ----- cd/m ²	<SYNC>NO SYNC
X -----	<LENS>STANDARD
y -----	<MEM>AUTO NUM
SELECT MEH DATA OR MEASURE.	<HOLD DATA>
NEXT : [ENTER]	Lv 90.41
[SFT] ● [2°]	x 0.4174
	y 0.4237

7. Press ENTER key.

After **"PLEASE WAIT..."** appears, measurement value has been set as target color.

When **"PLEASE WAIT..."** appears, do not switch OFF. Doing so may break stored data.

<TARGET>	<ANGL> 1° VIEW
CH01:Display*1	<SPD> AUTO
Lv 90.41 cd/m ²	<SYNC> 200.00Hz
x 0.4174	<LENS>STANDARD
y 0.4237	<MEM>AUTO NUM
<MODE>SINGLE	<HOLD DATA>
[SFT] ● [2°]	Lv 90.41
	x 0.4174
	y 0.4237

8. Press ESC key to return to measurement screen.

CH01:<DEFAULT>	<ANGL> 1° VIEW
Lv ----- cd/m ²	<SPD> AUTO
X -----	<SYNC>NO SYNC
y -----	<LENS>STANDARD
	<MEM>AUTO NUM
<MODE>SINGLE	<MEMORY DATA>
[SFT] ● [2°]	M000 :(NO DATA)
	Lv -----
	x -----
	y -----

(3) Through selection from saved data

Operation Procedure

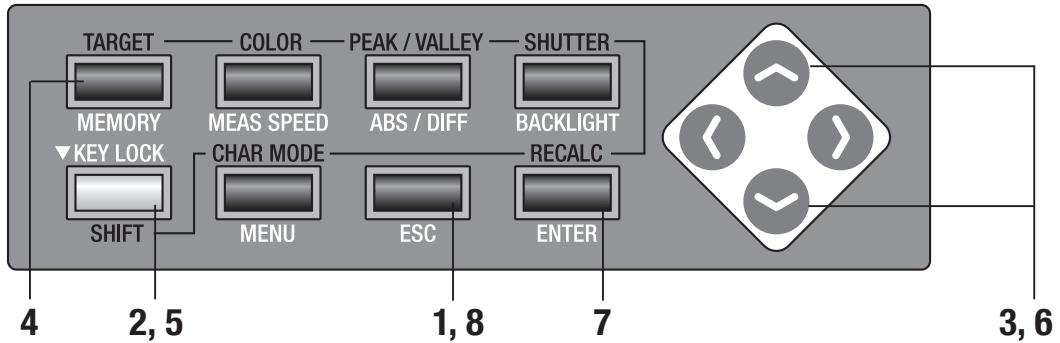

1. Press **ESC** key when menu or target value setting menu appears.

Measurement screen appears on LCD screen.

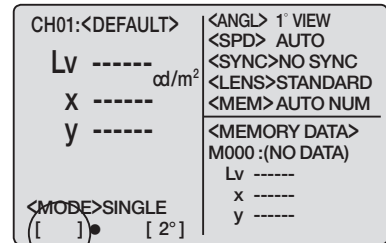

2. Press **SHIFT** key to switch to **SHIFT** mode.

[SFT] appears on left bottom. Or make sure that [SFT] appears on left bottom indicating that this instrument has been operated in SHIFT mode.



3. Press either **↑** or **↓** key to switch calibration channel and select one for which target color is to set.

Once target color is set, calibration channel cannot be returned to previous status before setting. Make sure to check channel number before overwriting.

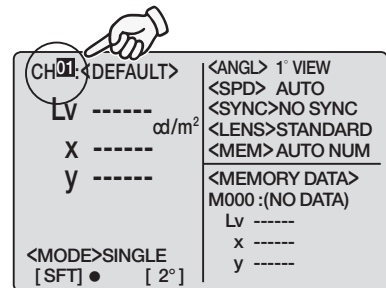

4. Press **TARGET** key.

<TARGET> screen appears.

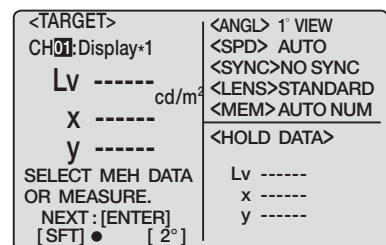

5. Press **SHIFT key to cancel **SHIFT** mode.**

<TARGET> CH01:Display*1 Lv ----- X ----- y ----- SELECT MEH DATA OR MEASURE. NEXT:[ENTER] []● [2°]	<ANGL> 1° VIEW <SPD> AUTO <SYNC>NO SYNC <LENS>STANDARD <MEM>AUTO NUM <HOLD DATA> Lv ----- x ----- y -----
---	--

6. Press either  or  key to select stored data.

<TARGET> CH01:Display*1 Lv 90.41 X 0.4174 y 0.4137 SELECT MEH DATA OR MEASURE. NEXT:[ENTER] []● [2°]	<ANGL> 1° VIEW <SPD> AUTO <SYNC>NO SYNC <LENS>STANDARD <MEM>AUTO NUM <MEMORY DATA> MO01: 90.78 x 0.3872 y 0.3996
---	--

7. Press **ENTER key.**

After “**PLEASE WAIT...**” appears, selected value has been set as target color.

When “**PLEASE WAIT...**” appears, do not switch OFF. Doing so may break stored data.

<TARGET> CH01:Display*1 Lv 90.78 X 0.3872 y 0.3996 BREAK:[ESC] []● [2°]	<ANGL> 1° VIEW <SPD> AUTO <SYNC>NO SYNC <LENS>STANDARD <MEM>AUTO NUM <MEMORY DATA> MO01: 90.78 x 0.3872 y 0.3996
--	--

8. Press **ESC key to return to measurement screen.**

CH01:<DEFAULT> Lv ----- X ----- y ----- <MODE>SINGLE []● [2°]	<ANGL> 1° VIEW <SPD> AUTO <SYNC>NO SYNC <LENS>STANDARD <MEM>AUTO NUM <MEMORY DATA> MO00:(NO DATA) Lv ----- x ----- y -----
--	--

(4) By entering numerical value

Operation Procedure

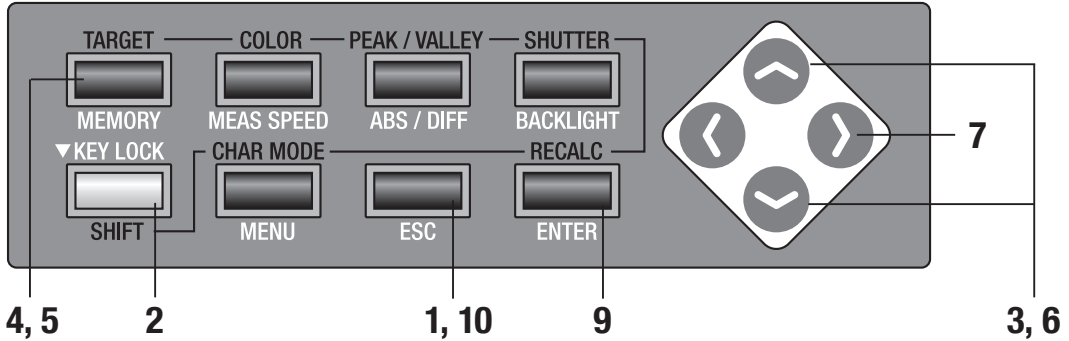

1. Press **ESC** key when menu or target value setting menu appears.

Measurement screen appears on LCD screen.

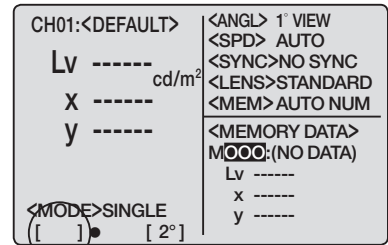

2. Press **SHIFT** key to switch to **SHIFT** mode.

[SFT] appears on left bottom. Or make sure that [SFT] appears on left bottom indicating that this instrument has been operated in SHIFT mode.

3. Press either  or  key to switch calibration channel and select one for which target color is to set.

Once target color is set, calibration channel cannot be returned to previous status before setting. Make sure to check channel number before overwriting.

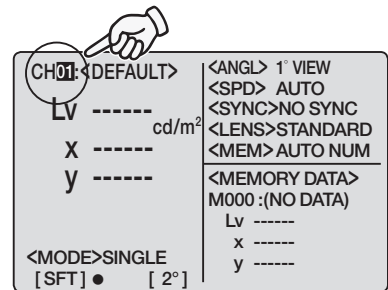

4. Press **TARGET** key.

<TARGET> screen appears.

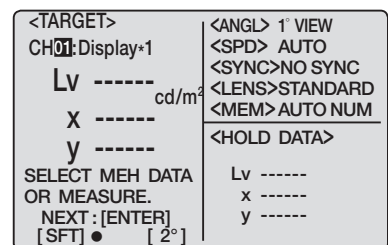

5. Press **TARGET** key to go to target color entry screen.

```

<TARGET>
CH01:Display*1
Lv -----cd/m2
x -----
y -----

<ANGL> 1° VIEW
<SPD> AUTO
<SYNC>NO SYNC
<LENS>STANDARD
<MEM>AUTO NUM

SET CAL VALUE.
OK:[ENTER]
[SFT]● [ 2°]
    
```

6. Enter target color in numerical value.

⬆ key: 0 to 9 in ascending order. K, M, decimal point and space available. If kept pressed, value continuously changes.

⬇ key: 9 to 0 descending order. K, M, decimal point and space available. If kept pressed, value continuously changes.

K and **M** show $\times 10^3$ and $\times 10^6$ respectively.

(See p.71 for details on 'Numerical value entry ranges')

```

<TARGET>
CH01:Display*1
Lv 9-----cd/m2
x -----
y -----

<ANGL> 1° VIEW
<SPD> AUTO
<SYNC>NO SYNC
<LENS>STANDARD
<MEM>AUTO NUM

SET CAL VALUE.
OK:[ENTER]
[SFT]● [ 2°]
    
```

7. Press ⬅ key to move the cursor to second digit position.

```

<TARGET>
CH01:Display*1
Lv 9-----cd/m2
x -----
y -----

<ANGL> 1° VIEW
<SPD> AUTO
<SYNC>NO SYNC
<LENS>STANDARD
<MEM>AUTO NUM

SET CAL VALUE.
OK:[ENTER]
[SFT]● [ 2°]
    
```

8. Repeat procedures from 6. to 7. as necessary to enter target color of Lv, x and y respectively.

Press **ESC** key to stop.

```

<TARGET>
CH01:Display*1
Lv 90.78-----cd/m2
x -----
y -----

<ANGL> 1° VIEW
<SPD> AUTO
<SYNC>NO SYNC
<LENS>STANDARD
<MEM>AUTO NUM

SET CAL VALUE.
OK:[ENTER]
[SFT]● [ 2°]
    
```

9. Press **ENTER** key.

After "PLEASE WAIT..." appears, entered value has been set as target color.

When "PLEASE WAIT..." appears, do not switch OFF. Doing so may break stored data.

```

<TARGET>
CH01:Display*1
Lv 90.78-----cd/m2
x 0.3545
y 0.3965

<ANGL> 1° VIEW
<SPD> AUTO
<SYNC>NO SYNC
<LENS>STANDARD
<MEM>AUTO NUM

SET CAL VALUE.
OK:[ENTER]
[SFT]● [ 2°]
    
```

10. Press **ESC** key to return to measurement screen.

```

CH01:<DEFAULT>
Lv -----cd/m2
x -----
y -----

<ANGL> 1° VIEW
<SPD> AUTO
<SYNC>NO SYNC
<LENS>STANDARD
<MEM>AUTO NUM
<MEMORY DATA>
M000:(NO DATA)
Lv -----
x -----
y -----

<MODE>SINGLE
[SFT]● [ 2°]
    
```



Measurement

Measurement

Operation Procedure

1. Decide whether you use close-up lens (optional) or not according to measuring object size and distance.

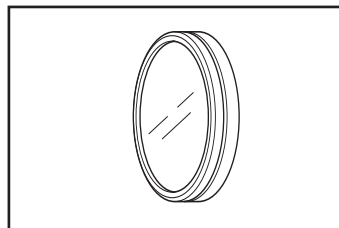
See the table below for details on measuring distance and measuring area. If you set close-up lens, lens type setting is required in this instrument. (see p.40)



Measuring distance and measuring area

(unit:mm)

(Measuring angle)	Minimum measuring area			Maximum measuring area			Minimum measuring distance			Maximum measuring distance			Measuring area at 500 mm			Measuring area at 1000 mm			
	1°	0.2°	0.1°	1°	0.2°	0.1°	1°	0.2°	0.1°	1°	0.2°	0.1°	1°	0.2°	0.1°	1°	0.2°	0.1°	
Without a Close-Up Lens	4.7	1.0	0.5	∞	∞	∞	296			∞			8.5	∅1.7	∅0.9	∅17.7	∅3.6	∅1.8	
Close-up Lens No.122	2.2	0.5	0.3	4.6	1.0	0.5	128			240			-	-	-	-	-	-	-
Close-up Lens No.107	0.8	0.2	0.1	1.1	0.3	0.2	43			52			-	-	-	-	-	-	-

*Measuring distance is the distance from the front edge of the metal lens barrel or close-up lens ring.

2. Slide measuring angle selector according to size of object and select either aperture 1°, 0.2°, or 0.1°.

* The measuring angle select is covered with holding cap CS-A24 (see p.8) at shipment from factory.

Pressing with finger cushion, slide measuring angle selector slowly.

Do not operate measuring angle selector during measurement. If measuring angle is switched during measurement, you may fail to perform measurement or to obtain correct measurement value.

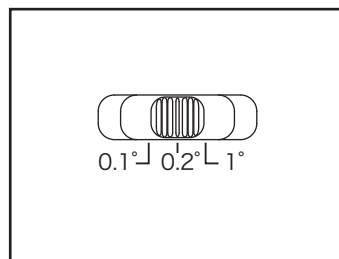

3. Rotate diopter adjustment ring on finder for diopter adjustment.

Make sure that aperture (black circle indicating measurement area) looks clear when observing object through finder. (See p.17.)

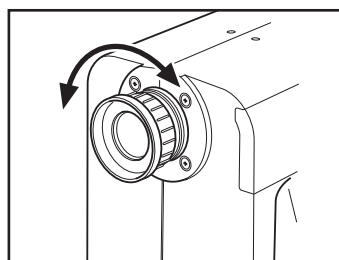

4. Rotate focus adjustment ring for objective lens for that purpose.

Make sure that object around aperture looks clear when observing object through finder. Only measuring area for measuring object must be placed in aperture. If extra area, which is not measuring object, is included in aperture, you cannot perform correct measurement.

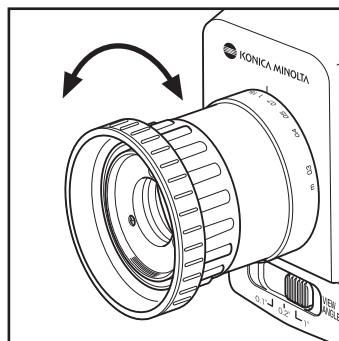

5. Press **ESC** key when menu or target value setting menu appears.

Measurement screen appears on LCD screen.

6. Press measurement button.

Securely support this instrument so that measuring object should not be removed from aperture when pressing measurement button.

L_v value appears in finder. (L_v value (Y value when observer angle is 10°) appears in any color space setting for LCD screen.)



Measurement result appears on LCD screen.

After measurement, do not switch OFF until measurement value appears. Doing so may break stored data.

To stop measurement in continuous, press measurement button or arbitrary key on LCD screen.

When long measurement time is set in single measurement, press measurement button or any option key before measurement is completed to stop measurement.



In case calibration channel is to specify for measurement, keep following procedure to select calibration channel before measurement.

Press either  or  key to switch calibration channel if measurement screen has been operated in SHIFT mode. Calibration channel can be changed after measurement in the same way, but recalculation is needed for measurement value after measurement.

For recalculation, press **RECALC** key if measurement screen is in SHIFT mode after changing calibration channel.

Recalculation can be done only for measurement data, not for stored data.

Keep following procedure to select memory channel before measurement if memory channel to store measurement value in is to specify in advance.

Press  or  key to switch memory channel if measurement screen is not in SHIFT mode.

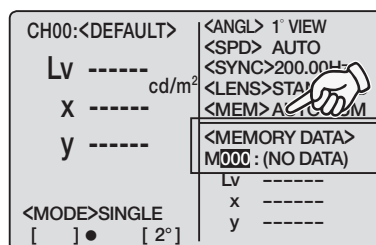
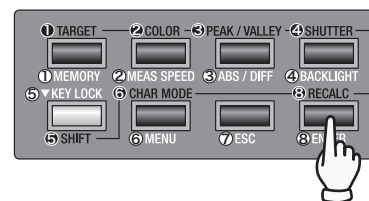
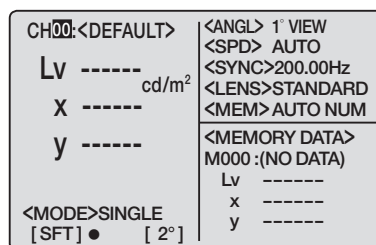
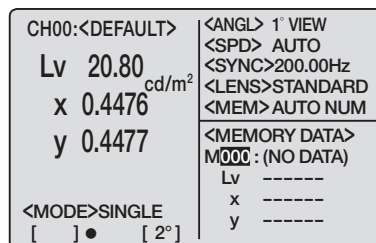
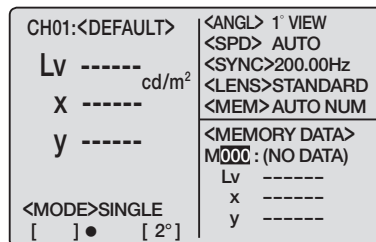

Storing Measurement Value

There are 100 directories to store measurement value from M000 to M100 and each can store one value, 101 in total. If memory channel update method has been set for [AUTO-SAVE], measurement value is to store after measurement automatically. In case of [AUTO NUM] or [MAN NUM], follow below procedure to store measurement value. (See p.50.)

Operation Procedure

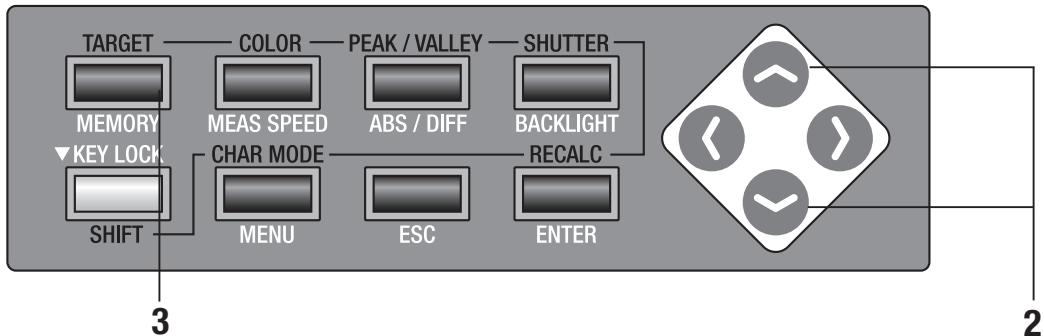

1. Make sure that [] is shown on bottom left of measurement screen indicating it has not been set for SHIFT mode.

If [SFT] appears instead, it means that instrument is to operate in SHIFT mode. Press **SHIFT** key to cancel SHIFT mode.

2. Press either  or  key to select memory channel.

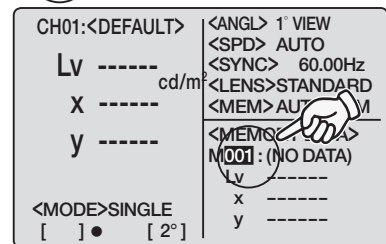
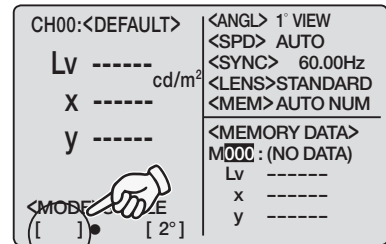

3. Press **MEMORY** key.

If **[MAN NUM]** has been set for memory channel update, measurement value is to store in selected channel.

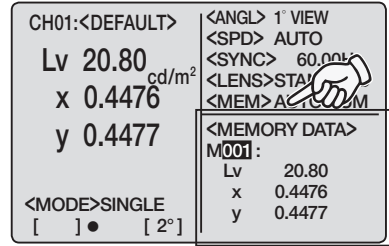

In case of **[AUTO NUM]**, measurement value is to store in selected channel and next channel number appears.

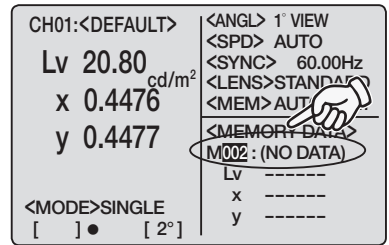

Maximum value/minimum value is stored in max/min value measurement. (Note that measurement value for every measurement is stored when **[AUTONUM]** is set in max/min value measurement.)

If set for **[AUTO NUM]** or **[AUTOSAVE]** and all memory channels have been used up, M000 is to use again to be overwritten.

In case that stored data already exists in the channel to store in, warning message **"OK TO OVERWRITE?"** appears.

If OK, press **ENTER** key, and if not, **ESC** key.

This warning message can be set not to appear. (See p.48.)

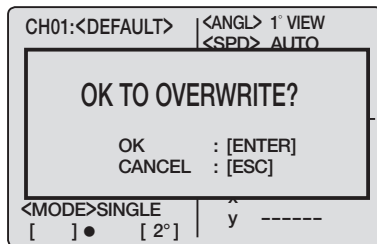

Displaying Stored Data and Setting Measurement Value ID Name

Follow below procedures to display stored data.

Operation Procedure

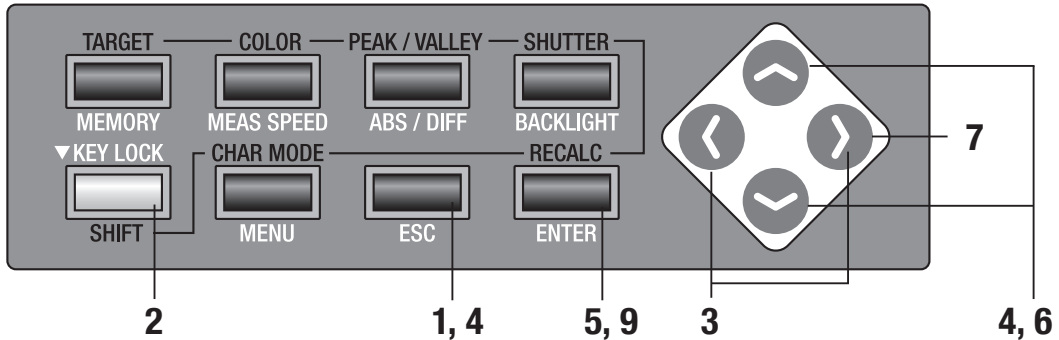

1. Press [ESC] key when menu or target value setting menu appears. Measurement screen appears on LCD screen.

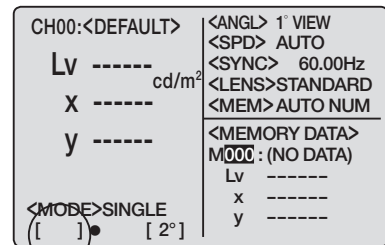

2. Make sure that [] appears on bottom left of measurement screen indicating it has not been set for SHIFT mode.

If [SFT] appears instead, it means that instrument is to operate in SHIFT mode. Press **SHIFT** key to cancel SHIFT mode.

3. Press either or key to move to save screen.

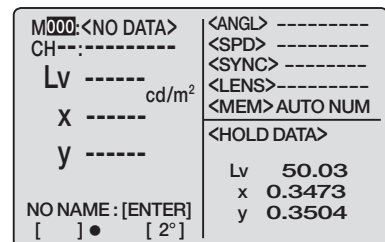

4. Press either or key to switch channel number.

: Number increases in descending order. If kept pressed, number continuously changes.
: Number decreases in ascending order. If kept pressed, number continuously changes.

Measurement value stored in memory channel

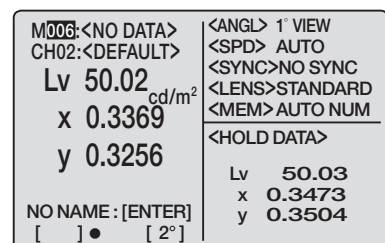

appears. Stored data is displayed on the condition when measurement was made. However, converted form in current color space for this instrument appears for color space.

To return to measurement screen, press either **▶** or **◀**, or **ESC** key.

Measurement value ID Name can be given to stored data.

Measurement value ID Name refers to name to each stored data by entering characters. It appears on LCD screen together with channel number. It is helpful if for which object user Measurement value ID Name has been used.

- Available number of characters to enter: 9 max
- Available type of characters to enter: A to Z, a to z, space, 0 to 9, symbol

5. Press [ENTER] key.

Measurement value ID Name appears on LCD screen.

<ID NAME> M006: [_] [A]	<ANGL> 1° VIEW <SPD> AUTO <SYNC>NO SYNC <LENS>STANDARD <MEM>AUTO NUM [HOLD DATA]
Lv 50.02 x 0.3369 y 0.3256	Lv 50.02 x 0.3473 y 0.3504
OK : [ENTER] [] ● [2°]	

6. Enter Measurement value ID Name.

⤴: A to Z in descending order and space. If kept pressed, character switches continuously.

⤵: Z to A in ascending order and space. If kept pressed, character switches continuously.

Small alphabet, numerical value, and symbols are also available.

See p.77 for details.

<ID NAME> M006: [S] [A]	<ANGL> 1° VIEW <SPD> AUTO <SYNC>NO SYNC <LENS>STANDARD <MEM>AUTO NUM [HOLD DATA]
Lv 50.02 x 0.3369 y 0.3256	Lv 50.02 x 0.3473 y 0.3504
OK : [ENTER] [] ● [2°]	

7. Press **▶** key to move cursor to second digit position.

8. Repeat procedure from 6. to 7 as necessary.

<ID NAME> M006: [SAMPLE] [A]	<ANGL> 1° VIEW <SPD> AUTO <SYNC>NO SYNC <LENS>STANDARD <MEM>AUTO NUM [HOLD DATA]
Lv 50.02 x 0.3369 y 0.3256	Lv 50.02 x 0.3473 y 0.3504
OK : [ENTER] [] ● [2°]	

9. Press [ENTER] key to return to save screen to show entered Measurement value ID Name.

M006: SAMPLE CH02: <DEFAULT> Lv 50.02 _{cd/m²} x 0.3369 y 0.3256	<ANGL> 1° VIEW <SPD> AUTO <SYNC>NO SYNC <LENS>STANDARD <MEM>AUTO NUM [HOLD DATA]
ID NAME : [ENTER] [] ● [2°]	Lv 50.02 x 0.3473 y 0.3504

Deleting Stored Data

Follow below procedures to delete stored data.

Operation Procedure

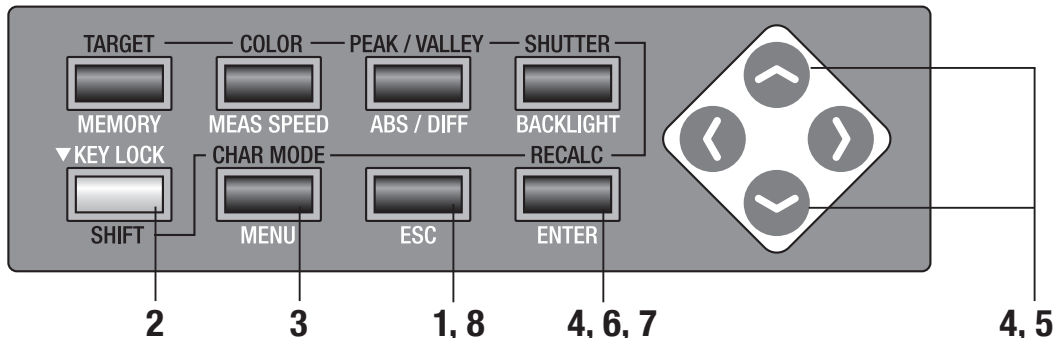

1. Press **ESC** key when menu or target value setting menu appears.
Measurement screen appears on LCD screen.

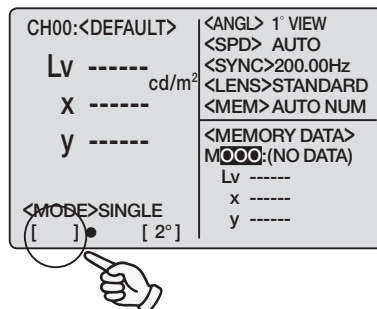

2. Make sure that [] appears on bottom left of measurement screen indicating it has not been set for SHIFT mode.
If [SFT] appears instead, it means that instrument is to operate in SHIFT mode. Press **SHIFT** key to cancel SHIFT mode.

3. Press **MENU** key.
Menu 1/4 screen appears on LCD screen.

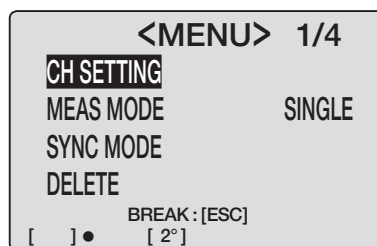

4. Press either or key to select **[DELETE]** and then **ENTER**.
< DELETE > screen appears.

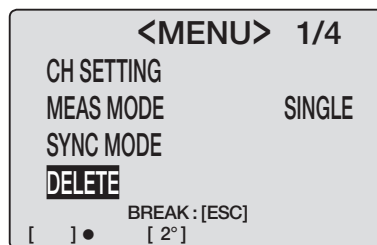

5. Press either  or  key to select channel number of which stored data is to delete.

Press  key and move cursor to **[ALL]** to delete all stored data not that only for individual channel.

```
<DELETE>
SELECT DATA
M009 ALL
OK TO DELETE ?
OK : [ENTER]
CANCEL: [ESC]
[ ]● [ 2°]
<ANGL> 1° VIEW
<SPD> AUTO
<SYNC>NO SYNC
<LENS>STANDARD
<MEM>AUTO NUM
<MEMORY DATA>
M009:
Lv 50.02
x 0.3666
y 0.3826
```

6. Press **ENTER key.**

Message "OK TO DELETE M***?" appears.

In case of deleting all data, message "OK TO DELETE ALL DATA?" appears.

```
<DELETE>
SELECT DATA
M009 ALL
OK TO DELETE ?
OK : [ENTER]
CANCEL: [ESC]
[ ]● [ 2°]
<ANGL> 1° VIEW
<SPD> AUTO
<SYNC>NO SYNC
<LENS>STANDARD
<MEM>AUTO NUM
<MEMORY DATA>
M009:
Lv 50.02
x 0.3666
y 0.3826
```

```
<DELETE>
OK TO DELETE
M009 ?
OK : [ENTER]
CANCEL: [ESC]
[ ]● [ 2°]
<ANGL> 1° VIEW
<SPD> AUTO
<SYNC>NO SYNC
<LENS>STANDARD
<MEM>AUTO NUM
<MEMORY DATA>
M009:
Lv 50.02
x 0.3666
y 0.3826
```

7. Press **ENTER key.**

(NO DATA) appears after stored data is deleted.

```
<DELETE>
OK TO DELETE
ALL DATA ?
OK : [ENTER]
CANCEL: [ESC]
[ ]● [ 2°]
<ANGL> 1° VIEW
<SPD> AUTO
<SYNC>NO SYNC
<LENS>STANDARD
<MEM>AUTO NUM
<MEMORY DATA>
M009:
Lv 50.02
x 0.3666
y 0.3826
```

8. Press **ENTER key twice to return to measurement screen.**

When **[ALL]** is set in procedure 5, press **ESC** key once.

```
<DELETE>
SELECT DATA
M009 ALL
OK TO DELETE ?
OK : [ENTER]
CANCEL: [ESC]
[ ]● [ 2°]
<ANGL> 1° VIEW
<SPD> AUTO
<SYNC>NO SYNC
<LENS>STANDARD
<MEM>AUTO NUM
<MEMORY DATA>
M009: (NO DATA)
Lv -----
x -----
y -----
```

Communication

Connecting to PC

This instrument can be used together with PC for mutual communication. Use USB cable (2m) IF-A33 supplied as standard accessory for this purpose.

USB cable is allowed to plug/unplug while power is on, but it is recommended to switch power off in this case.

Operation Procedure

- 1. Switch power OFF (O).**
- 2. Left protect cover and connect USB cable to USB connector of this instrument.**
- 3. Make sure that USB cable is all seated to USB connector.**

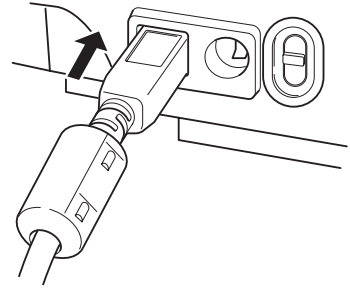

Communication interface in this instrument conforms to USB1.1.

Hold USB cable plug in unplugging. Do not pull cord part.

Plug USB cable to fit the connector entry point.

Any USB port on PC may be usable if there are multiple on PC. However, normal operation may not be secured if used with other USB units than CS-200.

Remote Mode

Remote mode refers to sending command from PC to this instrument with both connected. If this instrument is controlled with PC, "REMOTE MODE" appears on PC. When this message appears, key operation of this instrument is not acceptable except for following cases.

- If measurement button is pressed, measurement starts to forward its data to PC. (in case that measurement button is in valid mode by transferring command from PC to this instrument. Use data management software below.)
- **ESC** key is pressed to cancel remote mode.

Use standard accessory data management software CS-S10w Standard for this purpose.

See instruction manual of CS-S10w Standard for details on the spec and usage.

If you want to use independent program in PC to control this instrument, download Communication Specifications from KONICA MINOLTA's website at URL below for your reference.

<http://konicaminolta.com/instruments/download/software/index.html>

(Described URL above is subject to change without notice.)

(If the target page will not appear, please search the site by keywords, CS-200 and download.)

In addition to above tools, various data management can be done with CS-S10w Professional.

Description

Principle of Measurement

Spectral Fitting Method

Konica Minolta's newly-developed spectral fitting method provides tristimulus values (XYZ = red, green, blue) with significantly higher accuracy than that of conventional tristimulus colorimeters. This is achieved by using the output from 40 sensors to calculate the spectral response corresponding to human eye sensitivity (CIE 1931 color-matching functions).

- The CS-200 uses 40 sensors for sensitivity covering the entire visible region and multiplies each sensor output by appropriate coefficients. This adjusts the spectral response of the instrument to close to the CIE 1931 color-matching functions.
- In addition to the 2° Standard Observer, the 10° Standard Observer (for object-color measurements) can also be selected, which is impossible with conventional tristimulus colorimeters.

Object is measured with this spectral response and gained tristimulus values (X,Y, and Z) are converted into L_vxy , $L_vu'v'$, $L_vT\Delta uv$, and dominant wavelength through calculation to be displayed as measurement value.

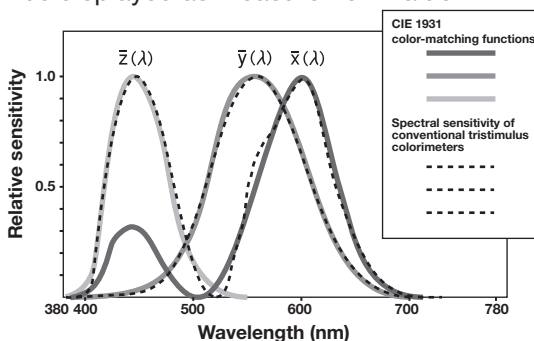

CIE 1931 color-matching functions and spectral response of a conventional tristimulus colorimeter

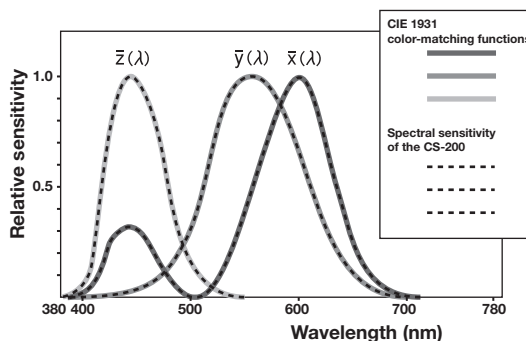

CIE 1931 color-matching functions and spectral response of the CS-200

Chromaticity coordinates (x,y) in L_vxy (CIE 1931 color space) can be obtained through following formula.

$$x = \frac{X}{X+Y+Z}, \quad y = \frac{Y}{X+Y+Z}$$

X,Y, and Z are tristimulus values.

$L_v T \Delta uv$

Following factors can be acquired as measurement value with $L_v T(d)uv$ as color space of this instrument.

- L_v : Luminance
- T : Correlated color temperature
- Δuv : Color difference from blackbody locus

While L_v stands for luminance, T and Δuv for color in $L_v T \Delta uv$.

<Relation between correlated color temperature T and color difference from blackbody locus Δuv >

Color temperature refers to the temperature of black body (perfect radiator) which has equal chromaticity coordinates to certain light. However, color temperature only represents colors on blackbody locus.

Correlated color temperature, slightly wider interpretation of color temperature, is very useful to eliminate such problem. Here, correlated color temperature covers those which are slightly outside the range of that of blackbody locus.

If a certain color positions on isothermperature line, the intersection point of isothermperature line and blackbody locus is indicated as correlated color temperature for the color. Isothermperature line means line on chromaticity coordinates which is a set of colors visually close to color temperature on blackbody locus.

However, since all colors on a color-matching temperature line are represented with equal correlated color temperature, it is not possible to describe color only with correlated color temperature. To solve that, Δuv , deviation of correlated color temperature T from blackbody locus, is to apply for that purpose. If Δuv exists above blackbody locus, it is represented with "+", and below, with "-".

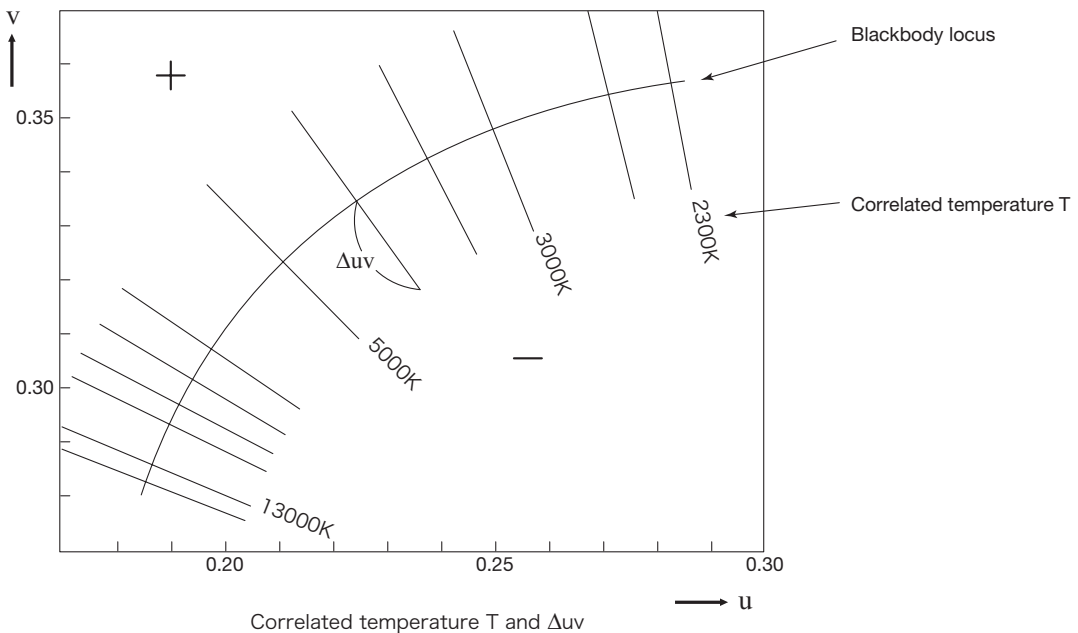

Dominant Wavelength

In the x, y chromaticity diagram shown below, the curve **VS_cSR** is the spectrum locus, and point **N** is the white point.

Colors located in the region enclosed by the spectrum locus and the straight lines **VN** and **NR** are referred to as spectral colors; colors located in the triangle **NVR** with the white point **N** at the apex and the pure purple line **VR** as the base are referred to as non-spectral colors.

Dominant wavelength (spectral colors)

For spectral colors, the dominant wavelength (generally symbolized as λ_d) is the wavelength corresponding to the point on the spectrum locus (the curve **VS_cSR**) where a line drawn from the white point through the chromaticity point obtained from the measured values intersects the spectrum locus. In the example shown, for a measured chromaticity point **C**, the dominant wavelength is the wavelength corresponding to point **S**, where the extension of line **NC** from the white point **N** through chromaticity point **C** intersects the spectrum locus.

Complementary wavelength (non-spectral colors)

For non-spectral colors, a line drawn from the white point through the chromaticity point obtained from the measured values does not intersect the spectrum locus (the curve **VS_cSR**), and instead intersects the pure purple line, which has no corresponding wavelengths. In such case, the complementary wavelength (generally symbolized as λ_c) is used instead of the dominant wavelength. The complementary wavelength is determined by extending the line in the opposite direction, from the chromaticity point through the white point to the spectrum locus, and using the wavelength corresponding to the point of intersection. In the example, chromaticity point **C'** is in the non-spectral region; the complementary wavelength is the wavelength corresponding to point **SC**, where the line extended from **C'** through white point **N** intersects the spectrum locus.

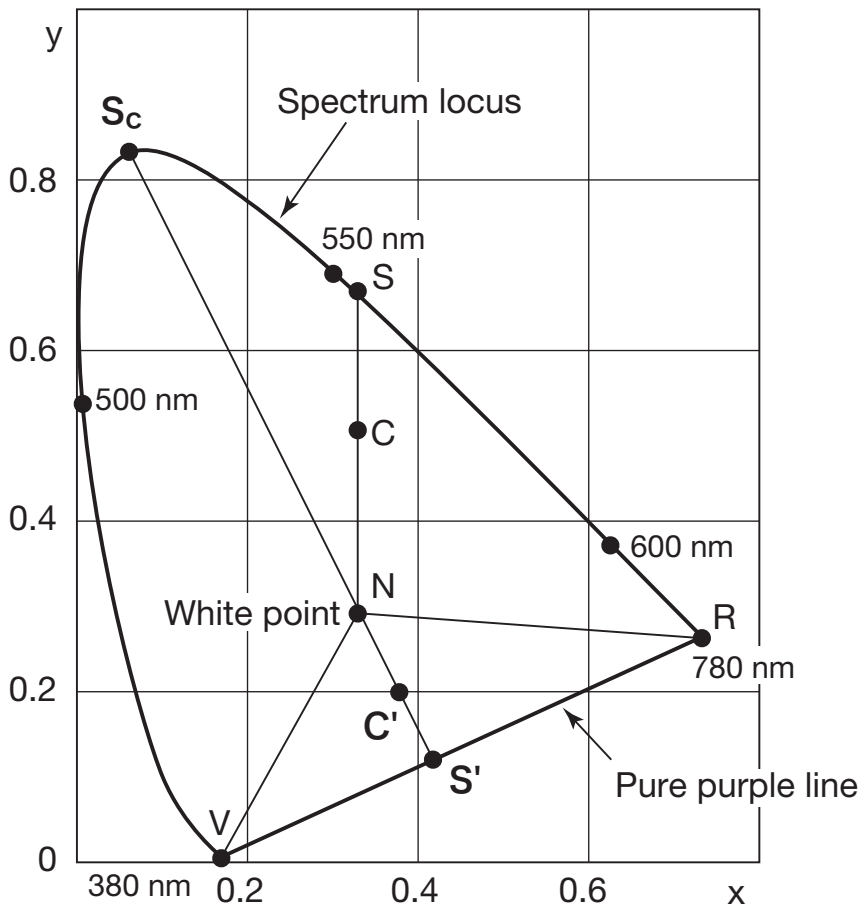

Dominant wavelength on chromaticity diagram

Measurement of Object Color

This instrument can perform simple measurement by utilizing user calibration function. This is also available by using standard accessory data management software CS-S10w Standard or optional CS-S10w Professional. Measured data is evaluated based on luminance which has been stored as light source data in CS-S10w. See instruction manual of CS-S10w for details.

- Set while calibration plate and object on the same position with the same angle from this instrument. Uniform illumination and measurement conditions of white calibration plate and those of object. If not, measurement data may vary, causing incorrect data.
- Keep illumination light source as stable as possible with fixed voltage power source during measurement.

Operation Procedure (Without data management software CS-S10w)

Setting Necessary for Object Color Measurement

1. Set one or more tungsten lumps or equivalent as illumination source toward white calibration plate as in the right illustration.

- Set this instrument vertical to white calibration plate.
- Keep the angle between illumination light source and white calibration plate at 45°.

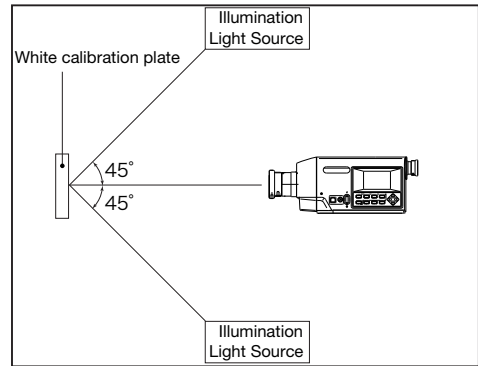

White Calibration

2. Perform user calibration.

- ◆ See p.64 for details.

Measurement of Object

3. Set object on the same position and at the same angle as white calibration plate.

4. Now, measurement can be done.

Operation Procedure (With data management software CS-S10w)

Setting Necessary for Object Color Measurement

- 1. Set one or more tungsten lumps or equivalent as illumination source toward white calibration plate as in the right illustration.**

- Set this instrument vertical to white calibration plate.
- Keep the angle between illumination light source and white calibration plate at 45°.

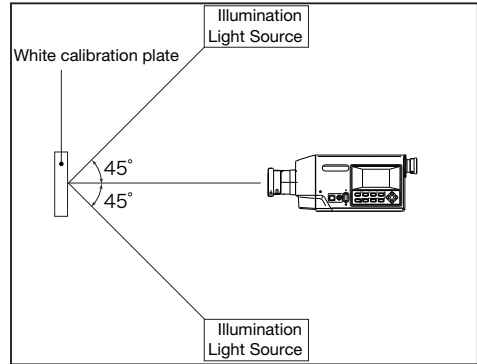

- 2. Start up this instrument, PC, and software CS-S10w.**

White Calibration

- 3. Set color measuring mode for object color with CS-S10w.**
- 4. Conduct white calibration with CS-S10w.**

Measurement of Object

- 5. Set object on the same position and at the same angle as white calibration plate.**
- 6. Now, measurement can be done with CS-S10w.**
 - ◆ See instruction manual of data management software CS-S10w for details.

Outer Dimensions

(Unit: mm)

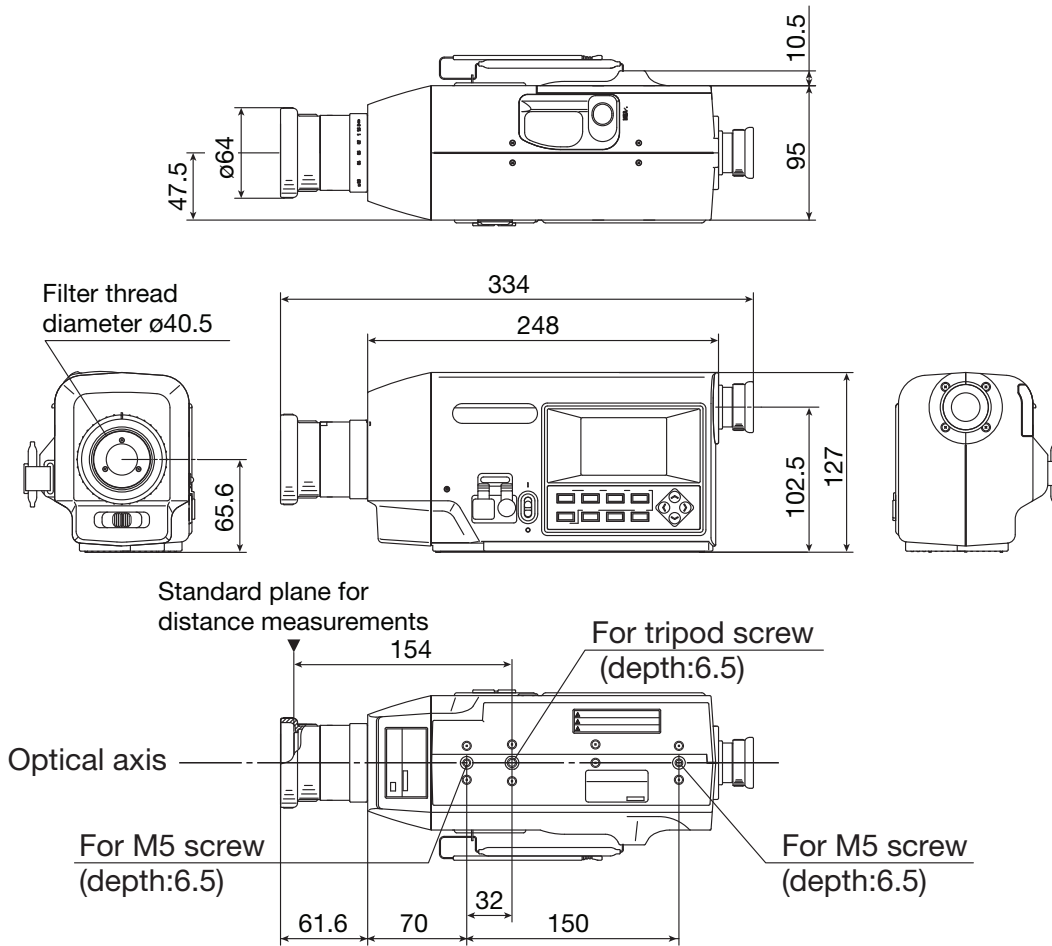

Error Messages

Error message appears on LCD screen for incorrect operation of this instrument through key. Below table shows type of error message, its description and corrective action respectively.

	Error message	Cause (Description)	Corrective Action
1	BATTERY OUT	Battery voltage decreases.	<ul style="list-style-type: none"> Switch this instrument OFF (O side), and replace with new batteries or use AC adapter.
2	DATA SET ERROR	Entered numerical value is out of range.	<ul style="list-style-type: none"> Enter again. Note that measurement value should completely satisfy the ranges below: $0 < x < 1$, $0 < y < 1$, $0 < x + y \leq 1$, $0 < X \leq 999999000000$, $0 < Y \leq 999999000000$, $0 \leq Z \leq 999999000000$
3	CH00 DATA NOT SETTABLE BY USER	When CH00 is selected, calibration channel is going to be operated or target color is going to be set.	<ul style="list-style-type: none"> Select channel except CH00 and redo the operation.
4	INCORRECT OBSERVER CONDITION	Measurement data measured with different observer angle from that for channel is going to be used for user calibration for that channel, or for target color setting.	<ul style="list-style-type: none"> Select measurement data measured with channel and observer angle or reset calibration channel, and redo setting.
5	NO DATA	Without measurement data, user calibration is going to be performed, or target color to be set.	<ul style="list-style-type: none"> Select data to measure or measurement data, and redo setting.
6	UNDER	Luminance of measuring object is lower than available measurement range.	<ul style="list-style-type: none"> Remove lens cap and check if luminance of measuring object is within available measurement range, and then redo measurement. Check if user calibration is correctly performed, and redo measurement. Check if settings for measurement angle, observer angle and lens are correct, and redo measurement. If symptom does not improve, please contact the nearest Konica Minolta-authorized service facility.

	Error message	Cause (Description)	Corrective Action
7	OVER	Luminance of measuring object is higher than available measurement range.	<ul style="list-style-type: none"> • Use ND filter and redo measurement. • If symptom does not improve, please contact the nearest Konica Minolta-authorized service facility.
8	OFFSET ERROR	Zero calibration has not been correctly performed.	<ul style="list-style-type: none"> • Reset the power and redo measurement. • If symptom does not improve, please contact the nearest Konica Minolta-authorized service facility.
9	EXCESSIVE LUMINANCE VARIATION	Luminance change for measuring object is large.	<ul style="list-style-type: none"> • Place this instrument on stable surface and redo measurement. • If symptom does not improve, please contact the nearest Konica Minolta-authorized service facility.
10	VIEWING-ANGLE SELECTOR ERROR	Measurement was performed when measurement angle selector was in wrong position, or measurement angle selector was changed during measurement.	<ul style="list-style-type: none"> • Switch measurement angle selector and check that measurement angle appears in screen (----- is not displayed), and then redo measurement. In addition, do not operate measurement angle selector during measurement. • If symptom does not improve, please contact the nearest Konica Minolta-authorized service facility.
11	ROM ERROR	Data stored in ROM is broken.	<ul style="list-style-type: none"> • Do not switch OFF (O side) while storing data or changing setting, or when message "PLEASE WAIT..." appears. • If symptom does not improve, please contact the nearest Konica Minolta-authorized service facility.

	Error message	Cause (Description)	Corrective Action
12	MEMORY ERROR	Data stored in ROM is broken, or backup batteries drain.	<ul style="list-style-type: none"> • Do not switch OFF (O side) while storing data or changing setting, or when message "PLEASE WAIT..." appears. • Switch ON (I side) to charge back-up battery. Backup battery is to fulfill its function after fully charged for approx. 20 hours. • If symptom does not improve, please contact the nearest Konica Minolta-authorized service facility.
13	INCORRECT CLOCK OPERATION	Clock IC does not operate correctly.	<ul style="list-style-type: none"> • Reset the power to set correct date and time. • If symptom does not improve, please contact the nearest Konica Minolta-authorized service facility.
14	A/D ERROR	Error in AD converter	<ul style="list-style-type: none"> • Reset the power to redo measurement. • If symptom does not improve, please contact the nearest Konica Minolta-authorized service facility.
15	RECALCULATION ERROR	There exists no measurement value for recalculation, or measurement value becomes lower than measurement available range after recalculation.	<ul style="list-style-type: none"> • Check that measurement value appears and redo measurement. • Check that user calibration is correct and redo measurement.

Error Check

Should error be found in this instrument, try corrective actions shown in the following table. If this does not help, this instrument has possibly been broken. Please contact the nearest Konica Minolta-authorized service facility with error number and version of your instrument. Version can be identified in procedure on p.116.

Error No.	Symptom	Item to Check	Corrective Action	Page to Refer
1	No display on LCD screen even after power is on.	Has AC adapter been properly plugged to AC outlet?	Connect AC adapter.	23
		Has AC adapter been connected to this instrument?	Connect AC adapter.	23
		Is AC power source within rated?	Use within +/-10% of the nominal voltage.	8
		Have batteries been placed?	Place batteries.	25
		Haven't batteries drained?	Replace with new batteries or connect with AC adapter.	25
2	Nothing is visible through finder.	Isn't lens cap on objective lens?	Remove lens cap.	-
		Hasn't ND filter covered objective lens?	Do not use ND filter except for the case when object to measure is of high luminance.	-
		Hasn't ND filter covered finder?	Do not use ND filter except for the case when object to measure is of high luminance.	-
3	Does not accept key operation.	Hasn't remote mode been set?	Press [ESC] key to cancel remote mode.	99
		Don't you press unfunctional key?	Press correct key.	-
		Hasn't it been KEY LOCK?	Press [KEY LOCK] key for approx. 2 or more seconds to release KEY LOCK.	14
4	Measurement unavailable even after pressing measurement button	Doesn't menu screen appear?	Conduct measurement with measurement screen appearing.	18
5	Gap between entered value in calibration value or target color and that appearing after setting		Calculation error could be found by 1 digit.	116

Error No.	Symptom	Item to Check	Corrective Action	Page to Refer
6	Measurement value appears as "-----".	Does data exist?	This appears when there is no data in measurement value, stored data, calibration value and target color.	-
		Doesn't color space become color temperature?	This appears when color temperature cannot be converted for display. Available display range is as follows: $2300 \leq T \leq 20000(K)$ $ \Delta uv < 0.1$	34
		Doesn't measurement value become larger by user calibration?	This appears when luminance value exceeds the available display area in this instrument.	-
		Do you set target color for color difference measurement?	This appears in color difference display when target color is not set.	78
7	Measurement values vary.	Is object to measure stable?	Keep object to measure stable.	-
		Isn't object to measure of low luminance?	Repeatability of x, y worsens if object of low luminance is measured. It becomes worse especially when measurement angle is 0.2° or 0.1°. Also it becomes worse especially when measurement time is FAST or Super-FAST. Measure in slower measurement time.	4 28
		Is measurement sync frequency appropriate when measuring display?	Set appropriate measurement sync frequency for proper measurement.	30
		Haven't ambient temperature and humidity rapidly changed?	Conduct measurement under environment free from such fluctuation.	3
8	Strange measurement value appears.	Is objective lens clean?	Wipe off with dry and soft cloth or lens cleaning paper.	106
		Has user calibration been performed correctly?	Redo user calibration.	64
		Haven't you put close-up lens on?	Select lens type setting corresponding to applied close-up lens.	62
		Haven't you put ND filter on?	Select lens type setting corresponding to applied ND filter.	40

Error No.	Symptom	Item to Check	Corrective Action	Page to Refer
9	Display of the remaining measurement time freezes, and measurement is not completed for the set measurement time.	Is object to measure stable?	When an object whose luminance has changed greatly from the previous measurement is measured, measurement may be interrupted to set the optimum gain for measurement and then remeasurement will be performed; during remeasurement, the remaining measurement time display is frozen. Keep object to measure stable.	
		Are you measuring an object whose luminance has changed greatly from the previous measurement?	When an object whose luminance has changed greatly from the previous measurement is measured, measurement may be interrupted to set the optimum gain for measurement and then remeasurement will be performed; during remeasurement, the remaining measurement time display is frozen.	
10	PC cannot read output data from this instrument when connected with USB. Command or data cannot be entered from PC to this instrument.	Has USB cable been tightly connected?	Connect this instrument and PC securely.	98
		Hasn't remote mode been cancelled?	Switch to remote mode by sending connection command from PC to this instrument. Use standard accessory data management software CS-S10w Standard.	99
		Has prepared program been correct?	Check referring to sample program. Use standard accessory data management software CS-S10w Standard.	-
11	Measurement data or various setting becomes invalid soon.	Hasn't backup battery been insufficient after a long time period of nonuse? Has backup battery been charged enough at the time of purchased?	Switch ON to charge backup battery. Backup battery is to fulfill its function after fully charged for approx. 20 hours. Shelf life of backup battery is 10 years under general use, but replacement is needed should memory disappears soon after full charge. For replacing backup battery, please contact the nearest Konica Minolta-authorized service facility.	4
12	Same error message appears repeatedly.	Check corrective action for error message.	If symptom does not improve, please contact the nearest Konica Minolta-authorized service facility.	108

Identifying Version

Operation Procedure

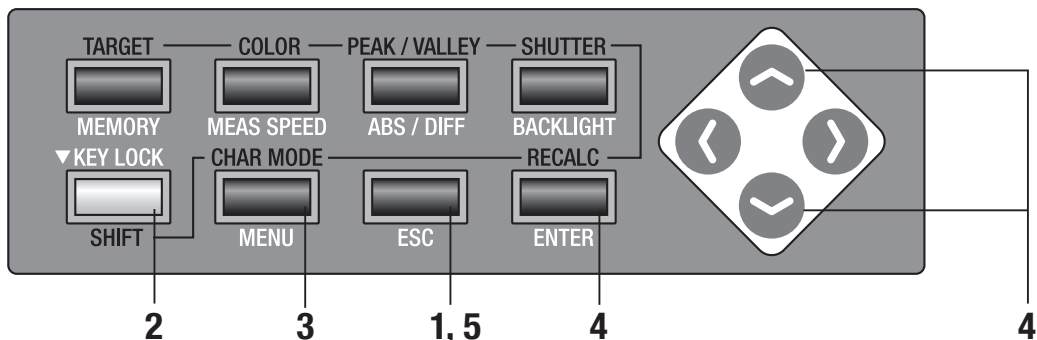

1. Press **ESC** key when menu or target value setting menu appears.
Measurement screen appears on LCD screen.

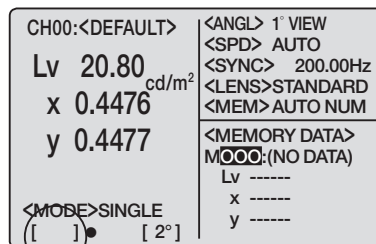

2. Make sure that [] appears on bottom left of measurement screen indicating it has not been set for **SHIFT** mode.

If [**SFT**] appears instead, it means that instrument is to operate in SHIFT mode. Press **SHIFT** key to cancel SHIFT mode.

3. Press **MENU** key three times.
Menu 3/4 screen appears on LCD screen.

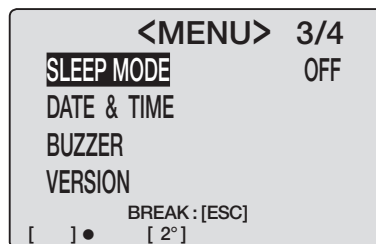

4. Press either  or  key to select **[VERSION]** and then **ENTER** key.

Such information as version No. appears on LCD.

5. Press **ESC** key twice to return to measurement screen.

```

<MENU> 3/4
SLEEP MODE OFF
DATE & TIME
BUZZER
VERSION
BREAK : [ESC]
[ ] ● [ 2° ]
  
```

```

<VERSION>
VER. 1.00.0000
S/N 0000000
BREAK : [ESC]
[ ] ● [ 2° ]
  
```

```

CH00:<DEFAULT> <ANGL> 1° VIEW
Lv 20.80<SPD> AUTO
x 0.4476<SYNC> 200.00Hz
y 0.4477<LENS>STANDARD
<MEM>AUTO NUM
<MEMORY DATA>
M000:(NO DATA)
Lv -----
x -----
y -----
<MODE>SINGLE
[ ] ● [ 2° ]
  
```

Changing Luminance Unit (cd/m² / fL)

You can select [cd/m²] or [fL] as luminance unit.

Operation Procedure

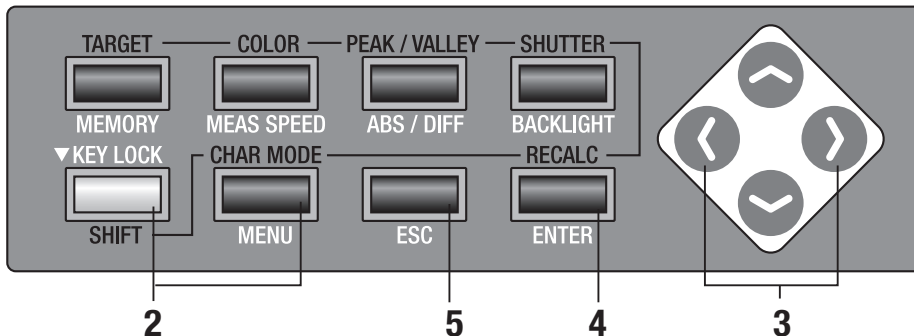

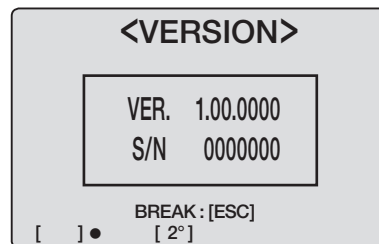

1. Follow procedures from 1. to 4. in “Identifying Version”(p.118) to display <VERSION> screen on LCD screen.

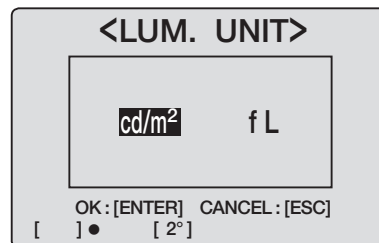

2. Press **SHIFT** key, **MENU** key and  key at the same time. <LUM.UNIT> appears on LCD screen.



3. Press  key or  key to select [cd/m²] or [fL]. Press **ESC** key to stop.

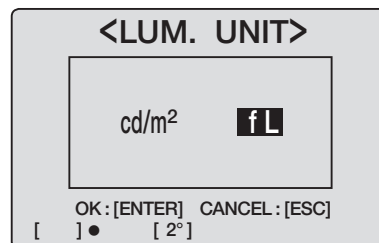

4. Press ENTER key.

<VERSION> screen appears on LCD screen.

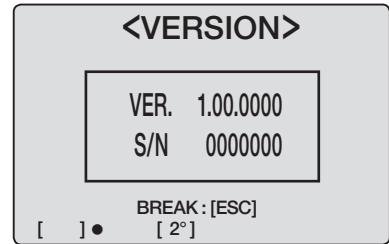

5. Press ESC key twice.

Measurement screen appears on LCD screen.

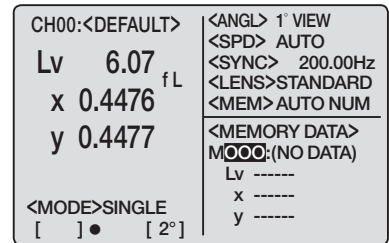

Specification

Item	CHROMA METER CS-200
Display range	0.01 to 200,000 cd/m ² (Measuring angle 1°) 0.01 to 5,000,000 cd/m ² (Measuring angle 0.2°) 0.01 to 20,000,000 cd/m ² (Measuring angle 0.1°)
Accuracy (Measuring angle 1°)*1 (Temperature: 23±2°, RH 65% max.)	150 cd/m ² (for illuminant A) L _v ±2 %±1digit xy ±0.002 0.01 to 0.5 cd/m ² (for illuminant A) L _v ±0.02 cd/m ² ±1digit --- 0.5 to 1 cd/m ² (for illuminant A) L _v ±0.02 cd/m ² ±1digit xy ±0.007 1 to 10 cd/m ² (for illuminant A) L _v ±2 %±1digit xy ±0.004 10 to 200,000 cd/m ² (for illuminant A) L _v ±2 %±1digit xy ±0.003 (5,000 cd/m ² for illuminant A) color filter (R,G,B) xy ±0.006
Repeatability (Measuring angle 1°)*2	0.01 to 1 cd/m ² (for illuminant A) L _v 0.01 cd/m ² +1digit --- (2 σ) (AUTO) 1 to 2 cd/m ² (for illuminant A) L _v 0.5 %+1digit xy 0.002 (2 σ) (AUTO) 2 to 4 cd/m ² (for illuminant A) L _v 0.5 %+1digit xy 0.001 (2 σ) (AUTO) 4 to 8 cd/m ² (for illuminant A) L _v 0.5 %+1digit xy 0.0005 (2 σ) (AUTO) 8 to 200,000 cd/m ² (for illuminant A) L _v 0.1 %+1digit xy 0.0004 (2 σ) (AUTO)
Measurement time	Automatically set between approx. 1 sec/meas. and 60 sec/meas. (AUTO) Automatically set to approx. 1 sec/meas. or 3 sec/meas. (LTD.AUTO) approx. 0.5 sec/meas.(Super-FAST) approx. 1 sec/meas.(FAST) approx. 3 sec/meas. (SLOW) approx. 12 sec/meas. (Super-SLOW)
Measurement method	Spectral method, Grating + linear photo diode array
Measuring angle	1°, 0.2°, 0.1° (Switchable)
Minimum measuring area	ø0.5 mm, ø0.1 mm (With close-up lens No.107)
Minimum measuring distance	296 mm (Distance from front edge of metal lens barrel)
Color space	L _v x y, L _v u' v', L _v TΔuv, XYZ, dominant wavelength
Measurement synchronization frequency	Vertical synchronization frequency:40.00 to 200.00 Hz
Interface	USB1.1
Power source	AC adapter and 4 AA-Size Batteries
Battery life	3 hours approx. (in Continuous measurement/FAST mode, with AA-Size battery under company testing KONICA MINOLTA's conditions.)
Size	95 (W) x 127(H) x 334(L) mm
Weight	1.8 kg (without battery)
Operating temperature /humidity range	0 to 40°C, RH 85 % or less (at 35°C) with no condensation
Storage temperature /humidity range	0 to 40°C, RH 85 % or less (at 35°C) with no condensation
Standard accessory	Lens cap, Holding cap CS-A24, ND eyepiece filter CS-A27, AC adapter AC-A305, Data management software CS-S10w Standard, USB cable (2 m) IF-A33
Optional accessory	Close-up lens No.107, Close-up lens No.122, ND filter (1/10) CS-A6, ND filter (1/100) CS-A7, Calibration instruction (For ND filter), Step up ring (40.5 to 55 mm) CS-A26, White calibration plate (For 45-0) CS-A20, White calibration plate (For d-0) CS-A21, White calibration plate CS-A22, Soft case CS-A23, Data management software CS-S10w Professional

*1. 23°C±2°C, L_v=0.01 to 10 cd/m² SLOW average of 30 measurements

L_v= 10 cd/m² and higher SLOW average of 10 measurements

*2. At 0.2° Measuring angle, the amount of received light is approx. 1/25 of that for 1°.

Therefore, the repeatability becomes the same as that for 1° with 25 times lower luminance.

0.1° Measuring angle, the amount of received light is approx. 1/100 of that for 1°.

Therefore, the repeatability becomes the same as that for 1° with 100 times lower luminance.

< CAUTION >

KONICA MINOLTA WILL NOT BE LIABLE FOR ANY DAMAGES RESULTING FROM THE MISUSE, MISHANDLING, UNAUTHORIZED MODIFICATION, ETC. OF THIS PRODUCT, OR FOR ANY INDIRECT OR INCIDENTAL DAMAGES (INCLUDING BUT NOT LIMITED TO LOSS OF BUSINESS PROFITS, INTERRUPTION OF BUSINESS, ETC.) DUE TO THE USE OF OR INABILITY TO USE THIS PRODUCT.



KONICA MINOLTA