

To buy, sell, or trade in this product please click on the link
<https://www.avionteq.com/GE-Sensing-Druck-DPI620G-Multifunction-Calibrator>



User Manual

Druck DPI620 Genii

GE Measurement & Control

Druck DPI 620 Genii Advanced Modular Calibrator K0541



© 2014 General Electric Company. All Rights Reserved. Specifications are subject to change without notice. GE is a registered trademark of General Electric Company. Other company or product names mentioned in this document may be trademarks or registered trademarks of their respective companies, which are not affiliated with GE

Contents

- 1 Overview 9
 - 1.1 Equipment in the Box..... 9
 - 1.2 Optional Items 10
 - 1.3 Observance of the User Manual 10
 - 1.4 General Safety Precautions..... 11
 - 1.5 General Warnings 12
 - 1.6 Electrical warnings 13
 - 1.7 Pressure Warnings 16
 - 1.8 Preparing the Instrument 17
 - 1.9 Install the Battery..... 17
 - 1.10 Charge the Battery 19
 - 1.10.1 Battery Charging Times 19
 - 1.11 Basic Modes 20
 - 1.11.1 Power On 20
 - 1.11.2 Power Off 20
 - 1.11.3 Power up from Standby Mode..... 21
 - 1.12 Druck DPI 620 Genii, Modes 22
 - 1.12.1 Dashboard navigation 23
 - 1.12.2 Set Date, Time and Language 24
 - 1.12.3 Themes..... 24
 - 1.12.4 Druck DPI 620 Genii Manual 24
 - 1.12.5 Alarm Status..... 24
 - 24

- To View Alarms select:..... 25
- 1.13 Software and Firmware Upgrades 26
 - 1.13.1 Viewing Software Revision..... 26
 - 1.13.2 Upgrading the Software..... 26
- 1.14 Maintenance 31
 - 1.14.1 Cleaning..... 31
- 1.15 Instrument Return 32
 - 1.15.1 Returned Material Procedure for USA..... 32
 - 1.15.2 Returned Goods Procedure for Europe 33
 - 1.15.3 Instrument Disposal in the European Union..... 34
- 1.16 Packaging for Storage or Transportation 35
 - 1.16.1 Environment..... 35
- 1.17 Marks and Symbols 35
- 2 Electrical Operations..... 36
 - 2.1 Basic Calibrator Operation 36
 - 2.1.1 Saving Tasks 37
 - 2.1.2 Electrical Tasks 38
 - 2.1.3 Favourites..... 40
 - 2.1.4 Custom Task..... 41
 - 2.2 Set the Function Utility Options..... 44
 - 2.2.1 Max/Min 44
 - 2.2.2 Switch Test 45
 - 2.2.3 Relief Valve..... 46
 - 2.3 Measurement Display Options 48
 - 2.4 Example Procedure: Measure or Source Current 50
 - 2.5 Example Procedure: Measure DC Voltage 51

- 2.6 Example Procedure: Measure AC Voltage (CH1), 0 to 20 Vrms Only 52
- 2.7 Example Procedure: Measure AC Voltage (CH1) with the AC Probe 53
- 2.8 Example Procedure: Source DC Voltage (CH1) 54
- 2.9 Example Procedure: Measure or Source Current with 24V Loop 55
- 2.10 Example Procedure: Measure or Source Frequency Signals 57
- 2.11 Example Procedure: Measure/Simulate a Resistance Temperature Detector (RTD) 59
- 2.12 Example Procedure: Measure or Simulate a Thermocouple (TC) 61
- 2.13 Example Procedure: Switch Test 63
- 2.14 Measure Pressure: IDOS Option 66
 - 2.14.1 IDOS Option Assembly Instructions 67
 - 2.14.2 IDOS Function Procedures 68
- 2.15 Error Indications 69
- 3 Pressure Indicator Operation (MC620) 70
 - 3.1 Parts and Assembly 71
 - 3.1.1 Assembly Instructions 73
 - 3.2 Pressure Connections 74
 - 3.2.1 Procedure (Attaching External Equipment) 74
 - 3.3 Procedure Overview 76
 - 3.4 Set up a Leak Test 79
 - 3.5 Set the Pressure Module to Zero 81
 - 3.6 Error Indications 82
- 4 Data Logging Operation 83
 - 4.1 Set-up 85
 - 4.2 Operation 87
 - 4.3 File Review 87

4.4	Chart View	88
4.5	File Management	89
4.5.1	Transfer	89
4.5.2	Erase.....	90
4.5.3	Memory Status.....	90
4.6	Data Format	91
5	Documentation	92
5.1	Analysis	92
5.2	Set-up.....	94
5.2.1	Define the Reference Channel	95
5.2.2	Define each Input Channel.....	96
5.3	Analysis Function	98
5.4	Run Procedure	99
5.4.1	Sequence to Upload and Download File.....	100
6	HART® Operations.....	101
6.1	HART® Menu Operations	101
6.2	Start-up	102
6.3	HART® Connections.....	103
6.4	Power Supply from the Calibrator	103
6.5	External Loop Power	104
6.6	Communicator Attached to a Network.....	105
6.7	Use of Test Connections	105
6.8	Viewing Primary Variables	106
6.8.1	Device Polling.....	106
6.8.2	Viewing HART® Configuration.....	107
6.9	Start HART® SDC Application	107

6.10	HART® Toolbar	110
6.11	Data Display	111
6.12	Editing Values.....	112
6.13	Executing Methods	114
6.13.1	Method Example - Self-test	115
6.13.2	Method Example - Analog Trim	116
6.14	Preferences	118
6.15	Failed to find Device	119
7	HART® Offline.....	120
7.1	Introduction	120
7.2	Start-up	120
7.3	Start HART® Offline	121
7.4	Create an Offline Configuration	122
7.4.1	Connected Configuration	123
7.4.2	Disconnected Configuration	124
7.5	Edit an Offline Configuration	125
7.6	Saving the Configuration.....	127
7.7	Uploading the Configuration	128
7.8	Working with Saved Configurations	128
7.8.1	Open HART Config.....	128
7.8.2	Upload Config to Device	128
7.8.3	Copy HART Config to USB	128
7.8.4	Delete HART Config.....	129
7.9	Further Operations	129
7.9.1	Delete All Configuration Files.....	129
7.9.2	Import Configuration Files from USB Memory stick.....	129

8	Foundation™ Fieldbus.....	130
8.1	Introduction	130
8.2	Start up.....	130
8.3	FOUNDATION™ Fieldbus Toolbar	133
8.4	Scanning For Devices	135
8.4.1	Context Sensitive Menu	137
8.4.2	Troubleshooting.....	139
8.5	Device Focus View.....	140
8.6	The Navigation Menu Tree	142
8.6.1	7.6.1 Block Header bar.....	143
8.7	Functional Group View	144
8.7.1	Displaying Parameter Help.....	146
8.7.2	Refreshing Data.....	147
8.7.3	Editing Values.....	148
8.7.4	Methods.....	149
8.8	Function Finder	150
8.9	Exporting Data to Main Genii Application	152
8.9.1	Viewing Exported Variables in Channel Window.....	154
8.10	My Block.....	155
8.11	Application Settings	157
8.11.1	Device Library.....	157
8.11.2	Options.....	158
8.11.3	Advanced	159
9	Calibration Procedures	160
9.1	Before Starting.....	160
9.2	Procedures (CH1/CH2): Current (measure)	163

9.3	Procedures (CH1/CH2): Current (source)	166
9.4	Procedures (CH1/CH2): DC mV/Volts (measure)	168
9.5	Procedures (CH1): DC mV/Volts (source)	170
9.6	Procedures (CH1): Frequency (measure/source)	172
9.7	Procedures (CH1): Frequency Amplitude (source)	178
9.8	Procedures (CH1): Resistance measure).....	180
9.9	Procedures (CH1): True Ohms (measure).....	182
9.10	Procedures (CH1): Resistance (source).....	183
9.11	Procedures (CH1): TC mV (measure or source)	185
9.12	Procedures (CH1): Cold Junction (TC method) and CJ (measure).....	187
9.13	Procedures (CH1): AC mV/Volts (measure)	190
9.14	Procedures: Pressure Indicator Modules (PM 620).....	192
9.15	Procedures: IDOS UPM	195
10	General Specification	196
10.1	Introduction	196
11	Manufacturer	199
12	Display Icons	200

1 Overview

The Druck DPI620 Genii is a battery-powered instrument for electrical measure and source operations and HART® communications. The Druck DPI620 Genii also supplies the power and user interface functions for all optional items. The touch-screen displays up to six different parameters.

This version of the manual is applicable to software revisions DK420 v2.01 and above.

1.1 Equipment in the Box

The following items are supplied with the Druck DPI 620 Genii:

- DC power supply
- Li-polymer battery
- Set of six test leads
- AC Probe
- Quick Start Guide
- Stylus

1.2 Optional Items

The items that follow are optional items which can be used with the Druck DPI 620 Genii:

- **Pressure Module Carrier, MC 620**, this attaches directly to the Druck DPI 620 Genii to make a fully integrated pressure instrument.
- **Pressure Module, PM 620**, this attaches to the pressure module carrier (MC 620) or a Pressure Station (PV 62X) to enhance the pressure measurement functionality.
- **Pressure Stations, PV 62X**, if the Druck DPI 620 Genii is installed in a Pressure Station, it becomes a fully integrated pressure calibrator.

1.3 Observance of the User Manual

This manual contains safety and battery installation information for the Druck DPI 620 Genii. It is the responsibility of the customer, to make sure that all personnel operating and maintaining the equipment are correctly trained and qualified. Before operating or using the equipment read and obey all sections, including all WARNINGS and CAUTIONS given in the Quick Start Guide.

1.4 General Safety Precautions

Read and obey all the operator's local Health and Safety regulations and Safe Working Procedures or Practices.

When doing a procedure or task:

- Use only the approved tools, consumable materials and spares to operate and maintain the equipment.
- Read and obey all applicable WARNING signs.
- Make sure that:

All work areas are clean and clear of unwanted tools, equipment and materials.

All unwanted consumable materials are discarded in accordance with local health and safety and environmental regulations.

1.5 General Warnings

- It is dangerous to ignore the specified limits for the instrument or its related accessories. This can cause injuries.
- If the equipment is used in a manner not specified by the manufacturer, the protection provided by the equipment may be impaired.
- Do not use the instrument in locations with explosive gas, vapour or dust. There is a risk of an explosion.
- Make sure all equipment is serviceable.
- Use equipment only for the purpose for which it is provided.
- Wear all applicable Personal Protective Equipment (PPE).
- Do not use sharp objects on the touch-screen.

1.6 Electrical warnings

- To prevent electrical shocks or damage to the instrument, do not connect more than 30V CAT I between the terminals, or between the terminals and the ground (earth).
- External circuits should have appropriate insulation to the mains.
- To prevent electrical shocks, use only the GE specified AC probe (Part: IO620-AC) to measure AC voltages that are more than 20 Vrms. Do not connect more than 300V CAT II between the IO620-AC leads, or between the leads and the ground (earth). Attach it to the specified connections only.
- This instrument uses a Lithium-Polymer (Li-Polymer) battery pack. To prevent an explosion or fire, do not short circuit, do not disassemble, and keep it safe from damage.
- To prevent an explosion or fire, use only the GE specified battery (Part: 191-356), power supply (Part: 191-339) and battery charger (Part: IO620-CHARGER).
- To prevent battery leakage or heat generation, only use the battery charger and power supply in the temperature range 0°C to 40°C (32°C to 104°F).
- The power supply input range is 100 – 240Vac, 50 to 60Hz, 250mA, installation category CAT II.
- Position the power supply so not to obstruct the supply disconnecting device.

- Note that the operating and storage temperature range of the mains PSU does not match that of the DPI620. Mains PSU operating temperature range 0°C to +40°C, storage temperature range -40°C to +70°C.
- The DC input to the DPI620 Genii is rated at 5V (+/-5%). Maximum current 2 Amps.
- To make sure the display shows correct data, disconnect the test leads before power is set to on or changing to another measure or source function.
- Make sure the power is OFF before connecting or disconnecting the probe.
- Keep the probe and leads free from all contaminants.

The following summary of installation and measurement overvoltage categories are derived from IEC61010-1. The overvoltage categories indicate the severity of overvoltage transients

Overvoltage Category	Description
CAT I	<i>Overvoltage category I has the least severe overvoltage transients. Generally CAT I equipment is not designed to be directly connected to the mains supply. Examples of CAT I equipment are process loop powered devices</i>
CAT II	<i>Overvoltage category II describes an electrical installation where typically single phase equipment is connected. Examples of such equipment are appliances and portable tools</i>

1.7 Pressure Warnings

- Some liquid and gas mixtures are dangerous. This includes mixtures that occur because of contamination. Make sure that the equipment is safe to use with the necessary media.
- To prevent a dangerous release of pressure, isolate and bleed the system before disconnecting a pressure connection.
- To prevent a dangerous release of pressure, make sure that all the related pipes, hoses and equipment have the correct pressure rating, are safe to use and are correctly attached.
- To prevent damage to the Druck DPI 620 Genii, only use it within the specified pressure limits.
- Do not exceed the maximum pressures stated in the appropriate component manual for the unit under test.
- Reduce pressure at a controlled rate when venting to atmosphere.
- Carefully de-pressurize all pipes to atmospheric pressure before disconnecting and connecting to the unit under test.
- Observe cleanliness when using the instrument.
- Severe damage can be caused if equipment connected to this instrument is contaminated.
- Connect only clean equipment to the instrument. To avoid any contamination, an external filter is recommended.

1.8 Preparing the Instrument

On receipt of the instrument check the contents in the box, listed in section 1.1. It is recommended to retain the box and packaging for future use.

1.9 Install the Battery

1. Remove the five Pozidriv screws **(A)** (Ref: Figure 1-1).
2. Remove the battery cover.
3. Check the connections on the battery line up with the connections in the battery compartment.
4. Place the battery in the battery compartment.
5. Replace the battery cover.
6. Secure the cover with the five Pozidriv screws.

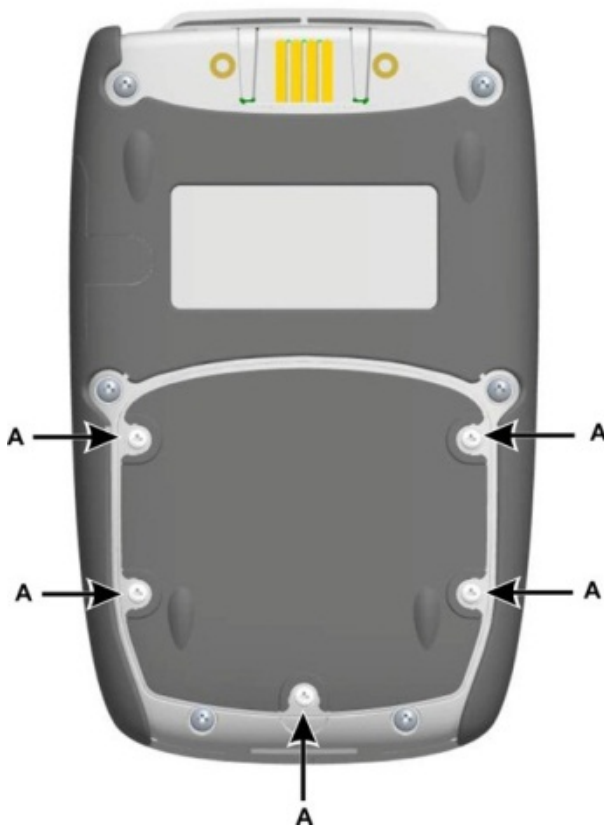

Figure 1-1

1.10 Charge the Battery

1. Connect the DC power supply into the +5V DC connection on the side of the unit (Ref: Figure 1-3).
2. The battery can also be charged using the USB connections (Ref: Figure 1-3).
3. The unit can be On or Off when charging. Charging times may be longer if charging when the unit is switched on.

1.10.1 Battery Charging Times

Charging Connection	Charge Time
DC Power Supply	6.5 hours
External Battery Charger	6.5 Hours

1.11 Basic Modes

1.11.1 Power On

From OFF – momentarily press the power button until the display flashes (Ref: Figure 1-3) .

1.11.2 Power Off

Press and Release the Power Button:

The POWERDOWN OPTIONS window will be displayed

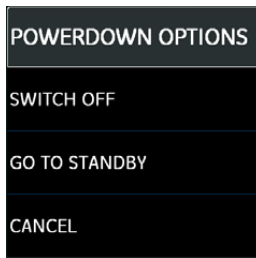

Figure 1-2 Powerdown Options

SWITCH OFF – Full power down of Druck DPI 620 Genii – recommended if unit is not going to be used for several hours (Requires full reboot on next power up)

STANDBY – DPI620G placed in standby mode – reduced power consumption from operating mode – recommended if unit is to be inactive for short periods. (Druck DPI 620 Genii has fast turn on from STANDBY mode).

Note: **SWITCH OFF** can also be achieved by pressing and holding the power button until the screen is blank.

1.11.3 Power up from Standby Mode

When powered-up from standby mode the instrument always opens the last screen shown before going into standby mode.

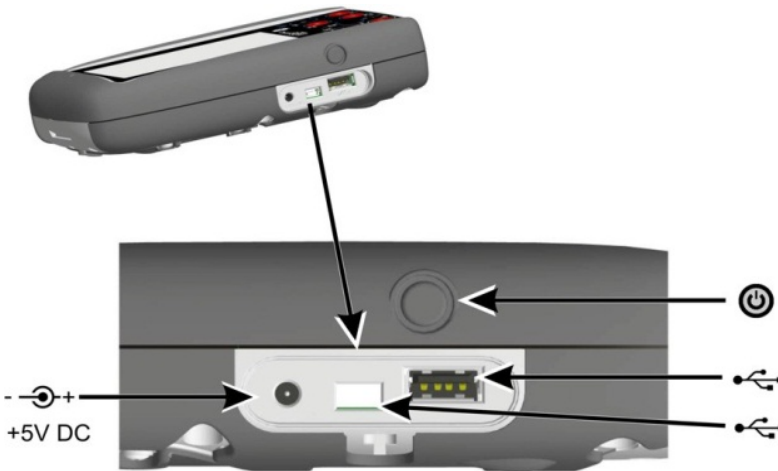

Figure 1-3

1.12 Druck DPI 620 Genii, Modes

The Druck DPI 620 Genii can be used as follows:

- Calibrator (with independent functions on each of six channels).
 - Data logging capabilities
 - Documenting capabilities
- HART® Communicator.
- Foundation Field-bus Communicator.

1.12.1 Dashboard navigation

The Dashboard is navigated by swiping a finger from top to bottom while touching the screen. Functions screens are navigated by swiping a finger from right to left while touching the screen.

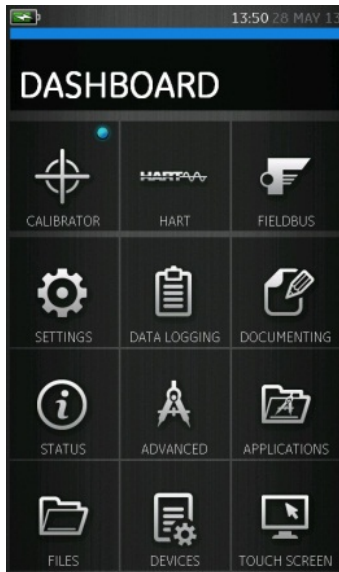

Figure 1-4 Dashboard

Note: *Fieldbus is not installed on all units*

1.12.2 Set Date, Time and Language

To access Date, Time and Language menus select:

DASHBOARD >>  SETTINGS >> DATE
>> TIME
>> LANGUAGE

1.12.3 Themes

Two themes are available: Dark and Light; select the correct theme for the light level. Select:

DASHBOARD >>  SETTINGS >> THEME

1.12.4 Druck DPI 620 Genii Manual

Select the Help icon on the Dashboard to access the manual. All the information required to operate the Druck DPI 620 Genii, is in the Help section of the Dashboard which is accessed by selecting:

DASHBOARD >>  HELP

1.12.5 Alarm Status

An Alarm Status is indicated on the DASHBOARD with a Red LED on the Status button and on the Home button on other screens.



1-5 Alarm Indication

To View Alarms select:

DASHBOARD >> ⓘ STATUS >> ALARM STATE

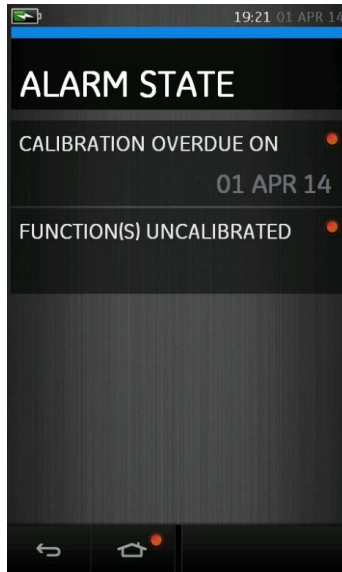

Figure 1-6 Alarm State

Selecting the Alarm will clear the indication until the next power down.

1.13 Software and Firmware Upgrades

1.13.1 Viewing Software Revision

The software revisions running on the Druck DPI 620 Genii can be viewed by selecting:

DASHBOARD >>  STATUS >> SOFTWARE BUILD

Note: If the software revision number is highlighted red then an upgrade is available.

1.13.2 Upgrading the Software

Follow the website instructions to download the files onto a USB flash memory device.

www.ge-mcs.com

1. Select:

DASHBOARD >>  ADVANCED

2. Enter the calibration PIN: 5487

3. Select the  button.

4. Select:

UPGRADE

5. Continue with one of these operations:

- **Upgrade the Application software and SDC625 Application.**

1. Copy the 'AMC' application folder into the root of a USB flash memory device.
2. Put the USB flash memory device in the USB type A connector.
3. Select:

APPLICATION

4. Follow the on-screen instructions.

Note: The SDC625 HART® Application can only be upgraded as part of an application upgrade.

- **Upgrade the Operating System and Bootloader software.**

1. Create a folder named 'OS' in the root of a USB flash memory device.
2. Copy the files 'DK418.nb0' and 'DK419.nb0' into the 'OS' folder.
3. Put the USB flash memory device in the USB type A connector.
4. Select:

OPERATING SYSTEM

5. Follow the on-screen instructions.

Note: The bootloader can only be upgraded as part of an operating system upgrade.

- **Upgrade the HART processor Application and Boot Loader**

1. Create a folder named 'HART' in the root of a USB flash memory device.
2. Copy the files 'DK416.s19' and 'DK417.s19' into the 'HART' folder.
3. Put the USB flash memory device in the USB type A connector.
4. Select:

HART APPLICATION

5. Follow the on-screen instructions.

Note: The HART bootloader can only be upgraded as part of an HART application upgrade.

- **Upgrade the CH1 FPGA**

1. Create a folder named 'FPGA' in the root of a USB flash memory device.
2. Copy the files 'DK413.bin' into the 'FPGA' folder.
3. Put the USB flash memory device in the USB type A connector.
4. Select:

CH1 FPGA

5. Follow the on-screen instructions.

Note: The CH2 cannot be remotely upgraded .

- **Upgrade the HART Device Library**

By default the HART device library is stored on the micro SD Card.

1. Set the DPI620 Genii USB client port to Storage Device mode by selecting:

DASHBOARD >>  DEVICES >> USB CLIENT PORT

2. Locate the self-extracting file 'DPI620_DD_library_20**_*.exe'
3. Connect DPI620 Genii Client USB port to PC USB port. Device will connect to PC as a Removable Disk.
4. Run 'DPI620_DD_library_20**_*.exe' and extract files to the Removable Disk (this will take several minutes due to the large file size).

**_* indicates the DD release version from the HART foundation.

The required directory structure on the micro SD card is shown in Figure 1-7 Hart DD Directory Structure.

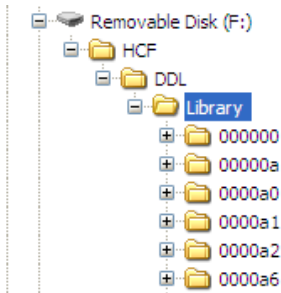

Figure 1-7 Hart DD Directory Structure

Note:

- *If a mistake is made during upgrade and there are no files to upload, follow the on-screen instructions and complete the procedure.*
- *When an upgrade completes normally, the initial operation of the touch screen may be slower (a period of approximately 30 seconds).*
- *To make sure the upgrade completed correctly, use the Status menu.*

1.14 Maintenance

The DPI620 Genii instrument contains no user serviceable parts and should be returned to a GE service center for repair.

1.14.1 Cleaning

CAUTION

Do not use solvents or abrasive materials.

Clean the case and display with a lint free cloth and a weak detergent solution.

1.15 Instrument Return

1.15.1 Returned Material Procedure for USA

If the instrument is unserviceable and requires a repair, return to a GE Service Centre or Approved Service Agent.

Web site: www.ge-mcs.com

Contact the GE Service Centre, either by 'phone, fax or e-mail to obtain a Returned Material Authorization (RMA) number, providing the following information:

Product (i.e. Druck DPI 620 Genii)

Serial number

Details of defect/work to be undertaken

Operating conditions

Safety Precautions

Provide information if the product has been in contact with any hazardous or toxic substances and the relevant MSDS references and precautions to be taken when handling.

Important notice

Do not use unauthorized sources to service this equipment as this will affect the warranty and may not guarantee future performance.

1.15.2 Returned Goods Procedure for Europe

If the instrument is unserviceable and requires a repair, return to a GE Service Centre or Approved Service Agent.

Web site: www.ge-mcs.com

Contact the GE Service Centre, either by 'phone, fax or e-mail to obtain a Returned Material Authorization (RMA) number, providing the following information:

Product (i.e. Druck DPI 620 Genii)

Serial number

Details of defect/work to be undertaken

Operating conditions

Safety Precautions

Provide information if the product has been in contact with any hazardous or toxic substances and the relevant COSHH references and precautions to be taken when handling.

Important Notice

Do not use unauthorized sources to service this equipment as this will affect the warranty and may not guarantee future performance. When discarding used equipment and batteries, obey all the local health and safety procedures.

1.15.3 Instrument Disposal in the European Union

Do not dispose of this product or its battery as household waste.



Use an approved organization that collects and/or recycles the applicable item.

For more information contact

- GE Sensing customer service department:
www.ge-mcs.com
- Local government office.

1.16 Packaging for Storage or Transportation

To store the unit or to return the unit for calibration or repair carry out the following procedures:

1. Pack the Instrument.
2. To return the instrument for calibration or repair, complete the return goods procedure (Ref: 1.14).
3. Return the instrument to the manufacturer or an approved service agent for all repairs.





1.16.1 Environment

The following conditions apply for both shipping and storage:

Temperature Range -20° to $+70^{\circ}\text{C}$ (-40° to $+158^{\circ}\text{F}$)

Altitude Up to 15,000 feet (4,570 metres)

1.17 Marks and Symbols

	Complies with FCC directives
	Complies with European Union directives
	USB ports: Type A; Mini Type B connector
	Ground (Earth)
	DC adaptor polarity: the centre of the plug is negative

2 Electrical Operations

2.1 Basic Calibrator Operation

1. Select:
DASHBOARD >>  CALIBRATOR
2. Select the channel by performing the following tasks:
 - Swipe to the TASK MENU by swiping the display from right to left.

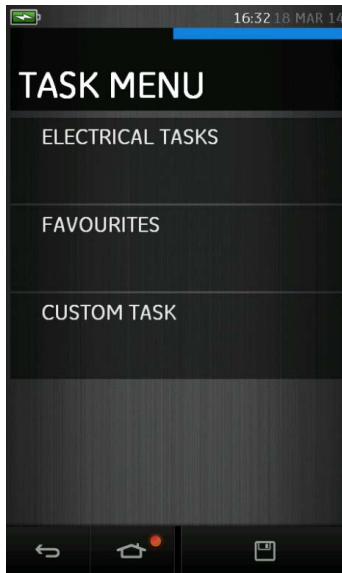



Figure 2-1 Task Menu

2.1.1 Saving Tasks

At any point within the **TASK MENU** the currently active tasks can be saved to **FAVOURITES** (refer to section 2.1.3) by selecting Save Task. 

Note: Saved Function is what is currently active in the calibrator window. It is NOT a selected Task – refer to **COPY TASK** in Section 2.1.2.

2.1.2 Electrical Tasks

1. Select ELECTRICAL TASKS from the TASK MENU.
 - This will allow the user to select from commonly used combinations of electrical functions



Figure 2-2 Electrical Tasks

2. Select the required function by selecting on either the appropriate text or diagram. The DPI620G will set the functions and return to the CALIBRATOR screen.

3. Functions can be copied to **FAVOURITES** (refer to section 2.1.3) by selecting as shown in Figure 2-3 and selecting Copy Task. 



Figure 2-3 Selected Task

If the required task is not available as a Default, a new task should be created using **CUSTOM TASK**. Refer to Section 2.1.3.

2.1.3 Favourites

1. Selecting FAVOURITES from the TASK MENU allows selection of all SAVED and COPIED tasks.

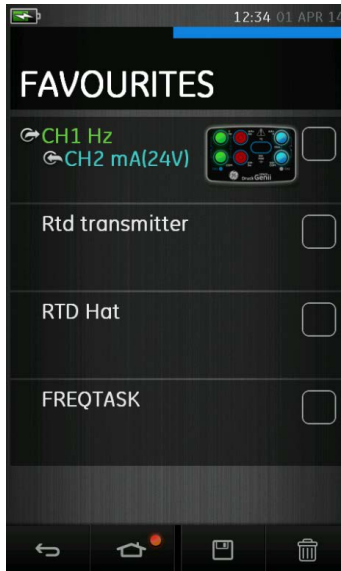



Figure 2-4 Favourites

2. Select the required function by selecting on either the appropriate text or diagram. The DPI620G will set the functions and return to the CALIBRATOR screen.
3. Tasks can be deleted by selected as shown in Figure 2-3 and selecting DELETE. 

2.1.4 Custom Task

1. Select CUSTOM TASK from the TASK MENU.
 - This will allow the user to set up Channels 1 & 2 in addition to the Pressure Channels, USB (IDOS) and Communications (HART or Foundation Fieldbus).

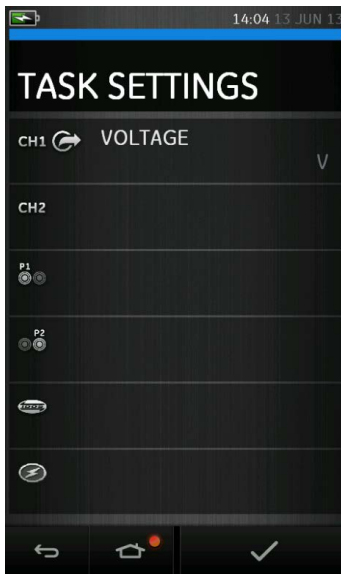





Figure 2-5 Task Settings Menu

3. Select CH1 or CH2 to enter the CHANNEL SETTINGS menu.

 P1 and  P2 are used for pressure measurements. (Refer to Section 3).

 IDOS is used for external IDOS sensors. (Refer to Section 2.14)





 is used for Hart® and FOUNDATION™ Fieldbus. (Refer to sections 6, 7 and 8).



Figure 2-6 Channel Settings Menu

4. Setup a channel for measurement.
 - **DIRECTION** selects  source or  measure for the selected function
 - **FUNCTION** selects the function required (eg Current or Voltage). For more options scroll down the menu by swiping the display from bottom to top.
 - **UNITS** selects the type of unit required, (eg Hz, kHz), please note that there may only be 1 type of unit available in particular Functions.
 - **UTILITY** selects the required utility (Refer to section 2.2 for details).
 - **CAPTION** allows the user to change the caption, if required.
5. Once all settings have been selected, press the  button at the bottom of the screen to return to the **TASK SETTINGS** screen.

Please note for the settings to be set the user must also press the  button in the **TASK SETTINGS** menu.
6. Repeat the above if another channel is required.

2.2 Set the Function Utility Options

For each function only one utility may be active. Not all source and measure functions have associated utilities.

For all options the  button resets the additional readings.

2.2.1 Max/Min

 This utility is only available with measure functions.

The additional values displayed show the minimum, maximum, and average values of the input signal.



Figure 2-7 Max/Min Example

2.2.2 Switch Test

- ⏏ This utility is available with measure or source functions.

The additional values displayed show signal values (measure or source) when the instrument detects a switch opening and closing. The difference between the two values is displayed as hysteresis value for the switch. This utility can be used with Ramp Automation, where the rising signal causes the switch to change state and the falling signal causes the switch to resume its' original state.

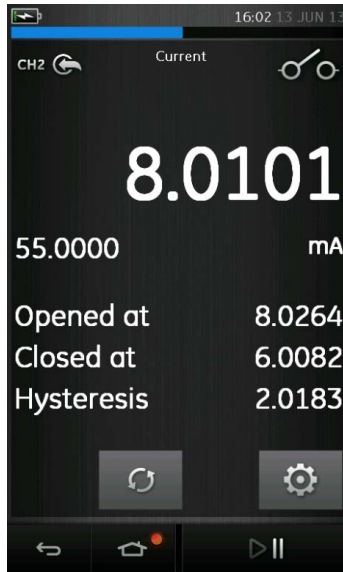



Figure 2-8 Switch Test Example

2.2.3 Relief Valve

 This utility is only available with measure functions.

This utility tests circuits or mechanisms that have a cut-out response when an input reaches a defined threshold value. The utility allows the user to select a mode of operation which can be rising or falling. The utility displays additional values that represent the maximum and minimum values achieved by the input signal.



Figure 2-9 Relief Value Example

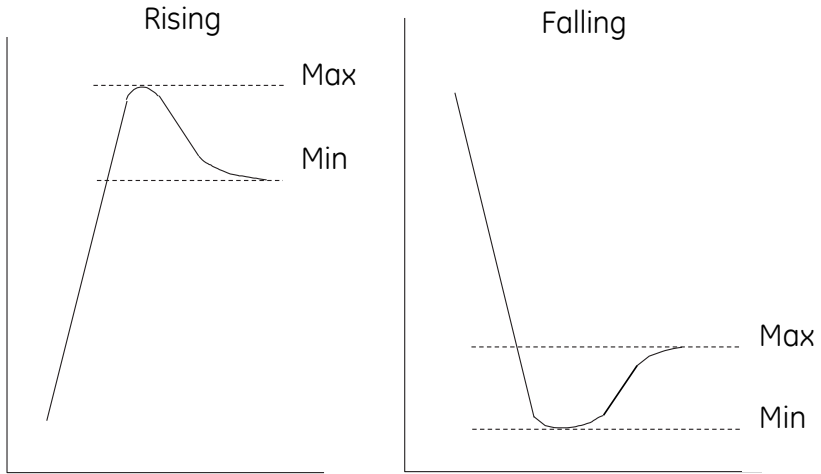

Figure 2-10 Relief Value Utility

-

2.3 Measurement Display Options

There are 2 display views in the CALIBRATOR screen when multiple channels are in use:

- Figure 2-11 displays a reduced view of all the selected channels.

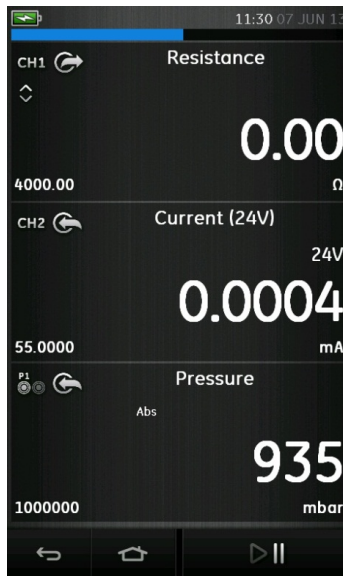



Figure 2-11 Calibrator Window – Reduced View

- Figure 2-12 displays an expanded view of the selected channel and minimizes the remaining channels.



Figure 2-12 Calibrator Window - Expanded View

The displays options can be changed by pressing the channel the user wants to display in expanded view.

Selecting  displays all channels in the reduced view

2.4 Example Procedure: Measure or Source Current

Figure 2-13 shows CH1 set-up to measure or source a current with external loop power.

Note: When using the CH2 connectors, set CH 2 to measure or source these ranges with internal or external loop power. Set the appropriate function by selecting mA or mA +24V. Loop power has three possible settings:

- 1) OFF
- 2) 24V
- 3) 28V

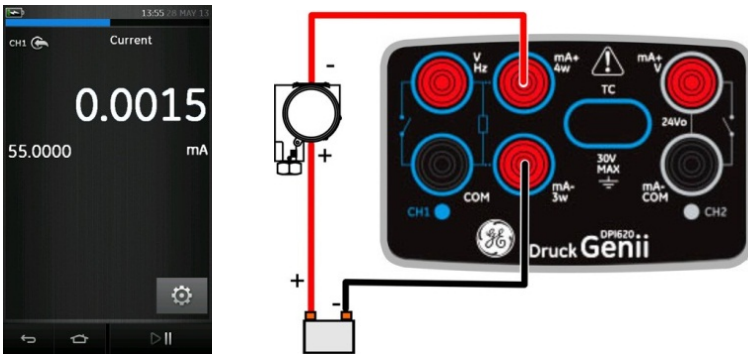

Figure 2-13 Measure current on CH1. Range ± 55 mA

1. Set the applicable software option.
2. Complete the electrical connections and continue with the measure or source operation.
3. Source only (Automation). Set the applicable output value.

2.5 Example Procedure: Measure DC Voltage

Figure 2-14 shows CH1 set-up to measure a DC voltage (0 to 30 V) or DC mV (0 to 2000 mV)

Note: When using the CH2 connectors, set-up CH2 to measure these range.



Figure 2-14 Measure DC Volts or DC mV on CH1. Range ± 30 V

1. Set the applicable software options
2. Complete the electrical connections and continue with the measure operation

2.6 Example Procedure: Measure AC Voltage (CH1), 0 to 20 Vrms Only

WARNING

To prevent electrical shocks, use only the GE specified AC probe (Part: IO620-AC) to measure AC voltages that are more than 20 Vrms (maximum: 300 Vrms). Refer to Section 2.7.

Figure 2-15 shows CH1 set-up to measure an AC voltage (0 to 20 Vrms) or AC mV (0 to 2000 mVrms).

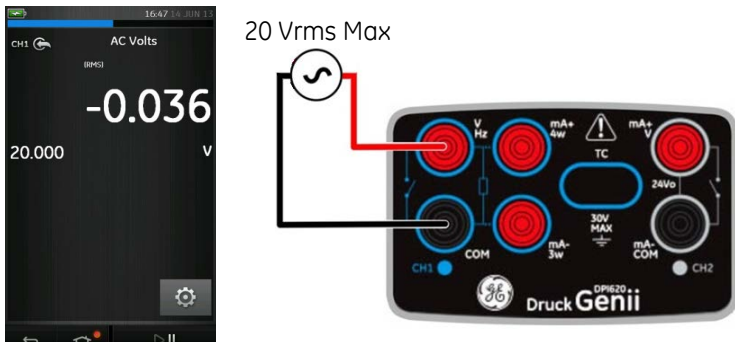

Figure 2-15 Measure AC Volts or AC mV on CH1. Range ± 20 Vrms

1. Set the applicable software options.
2. Complete the electrical connections and continue with the measure operation.

2.7 Example Procedure: Measure AC Voltage (CH1) with the AC Probe

WARNING

To prevent electrical shocks, use only the GE specified AC probe (Part: IO620-AC) to measure AC voltages that are more than 20 Vrms (maximum: 300 Vrms). Attach it to the specified connections only.

Figure 2-16 shows CH1 set-up to measure an AC voltage with the AC probe Maximum: 300 V rms.

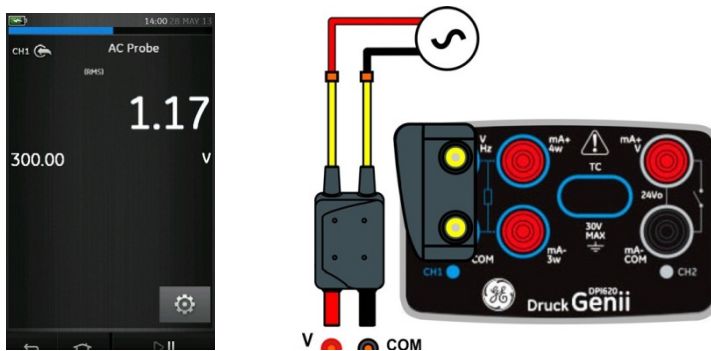

Figure 2-16 Measure AC Volts with AC Probe. Range 300 Vrms

1. Set the applicable software options for the AC Probe.
2. Complete the electrical connections Red - V/Hz connector, Black - COM connector. Then continue with the measure operation.

2.8 Example Procedure: Source DC Voltage (CH1)

Figure 2-17 shows CH1 Set-up to source a DC voltage on CH1 (0 to 20V).

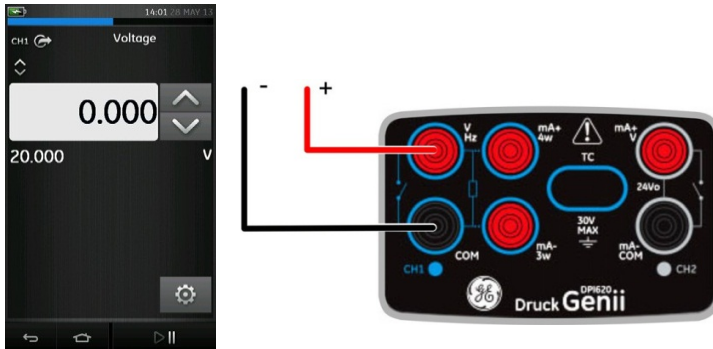

Figure 2-17 Source Voltage on CH1. Range 0 to 20V.

1. Set the applicable software options.
2. Complete the electrical connections.
3. To continue, set the applicable output value.

2.9 Example Procedure: Measure or Source Current with 24V Loop

Figure 2-19 and Figure 2-18 show CH2 set-up to measure ($\pm 55\text{mA}$) or source (0 to 24mA) a current with internal loop power (Selectable to 24 V or 28V).

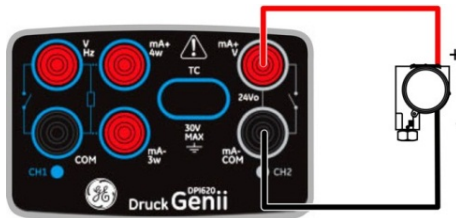

Figure 2-19 Measure current on CH2 with internal loop power (Range: $\pm 55\text{mA}$)

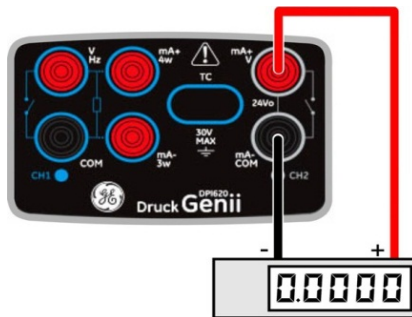

Figure 2-18 Source current on CH2 with internal loop power. (Range: 0 to 24 mA)

Set the applicable software options.

1. Complete the electrical connections and continue with the measure or source operation.
2. Source only (Automation): Set the applicable output value.

Note: The current limit of the Loop power is 30mA.

2.10 Example Procedure: Measure or Source Frequency Signals

Figure 2-20 and Figure 2-21 show CH1 set-up to measure or source a frequency. The units could be Hz, kHz or counts (cpm or cph).

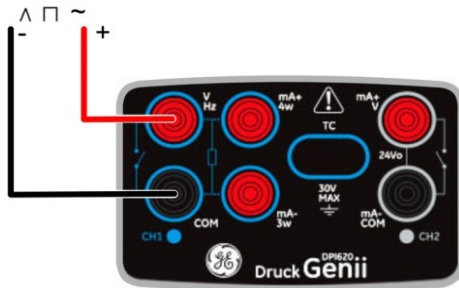
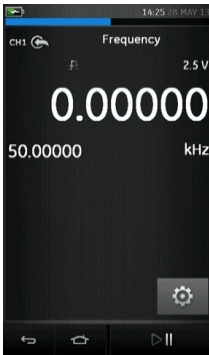

Figure 2-20 Example A - Measure Frequency on CH1 (Range 0 to 50 kHz)

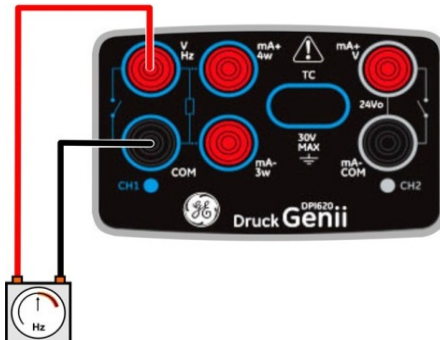
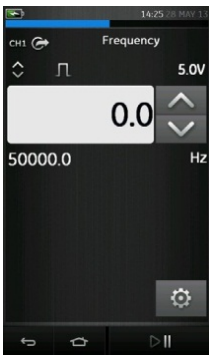



Figure 2-21 Example B - Source Frequency CH1 (Range 0 to 50 kHz)

Example A	Example B
<p>Measure frequency on CH1</p> <p>Range: 0 to 50 kHz</p> <p>Trigger level: 2.5V</p>	<p>Source frequency on CH1</p> <p>Range: 0 to 50 kHz</p> <p>Waveform: Square</p> <p>Amplitude:5.0 V</p>
<ol style="list-style-type: none"> 1. Set the applicable software options 2. Complete the electrical connections 3. If necessary, change the Trigger Setup <ul style="list-style-type: none">  SETTINGS >> AUTO TRIGGER 4. Set the values that follow: <ul style="list-style-type: none"> AUTO TRIGGER (Enabled / Disabled) MANUAL LEVEL Trigger Level for Manual Trigger only 	<ol style="list-style-type: none"> 1. Set the applicable software options 2. Complete the electrical connections 3. If necessary, change the Waveform Setup: <ul style="list-style-type: none">  SETTINGS 4. Set the values that follow: <ul style="list-style-type: none"> WAVEFORM Square Triangle Sine AMPLITUDE Peak to Peak Amplitude OFFSET Only Applies to Sine and Triangle

2.11 Example Procedure: Measure/Simulate a Resistance Temperature Detector (RTD)

Figure 2-22 and Figure 2-23 show CH1 set-up to measure or simulate an RTD. A 4-wire configuration gives the best accuracy; a 2-wire configuration has the lowest accuracy (4- wire RTD shown).

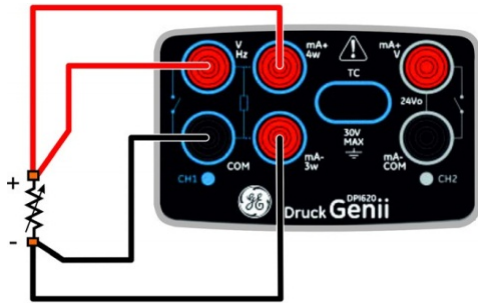
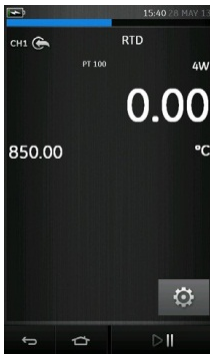

Figure 2-22 PT100 RTD Measure CH1 4-Wire (Range -200 to 850 °C)

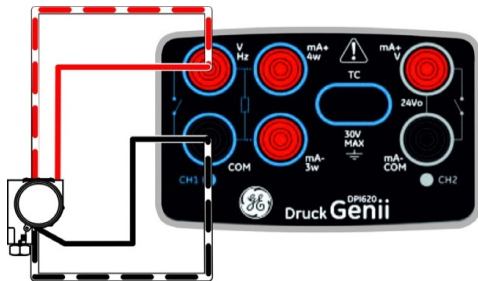

Figure 2-23 PT100 RTD Source CH1 4-Wire (Range -200 to 850 °C)

Note: To measure or simulate resistance Ω , select the Resistance function (Range 0 to 4000 Ω).

1. Set the applicable software options.
2. Complete the electrical connections.
3. If necessary change the RTD Type.



SETTINGS >> RTD TYPE

2.12 Example Procedure: Measure or Simulate a Thermocouple (TC)

Figure 2-24 and Figure 2-25 show CH1 set-up to measure or simulate a TC temperature.

To measure or simulate TC millivolts, set the TC mV function.

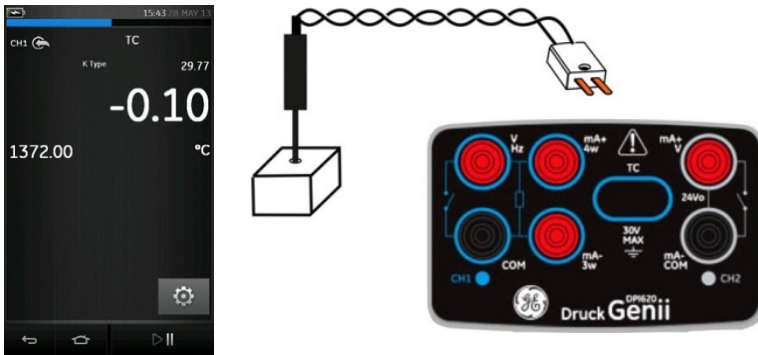

Figure 2-24 K-Type Thermocouple Measure CH1 (Range -270 to 1372 °C)

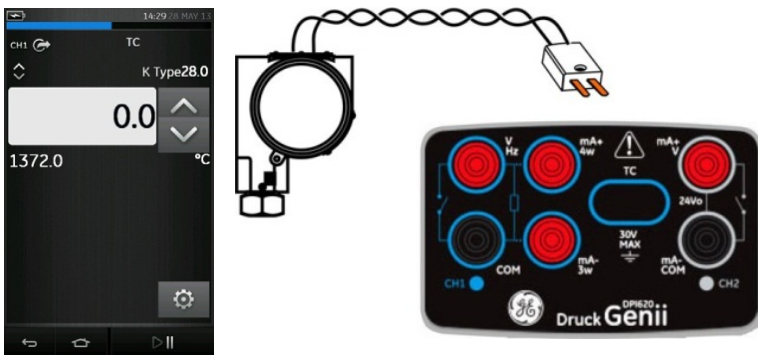



Figure 2-25 K-Type Thermocouple Source CH1 (Range -270 to 1372 °C)

Note: To measure or simulate TC millivolts, set the TC mV function

1. Set the applicable software options.
2. Complete the electrical connections.
3. If necessary change the thermocouple type.

 **SETTINGS >> TC TYPE**

4. Set CJ Compensation mode.

 **SETTINGS >> MANUAL CJ COMPENSATION**

If Manual CJ compensation is not selected, the internal cold junction is used to calculate the thermocouple value.

If using an external cold junction, select check box on **MANUAL CJ COMPENSATION** and enter value for cold junction temperature.

2.13 Example Procedure: Switch Test

CH1, P1, P2 and IDOS functions use the CH2 switch connections. CH2 functions use the CH1 switch connections.

Switch operation

When setting the Switch Test utility on one channel, the software automatically sets-up the other channel for the switch connections.

Note: *If there is a measure or source function on the switch connection channel it is automatically disabled. The display will show a screen message:*

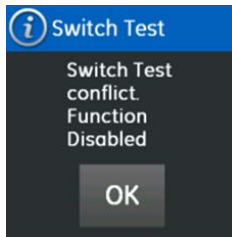

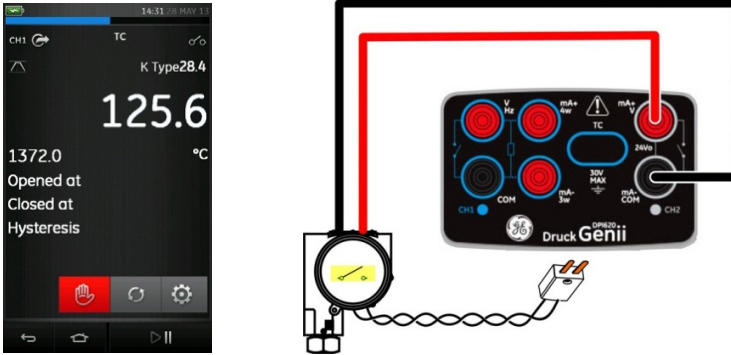





Figure 2-26 CH1 Thermocouple Source CH2 Switch Test

Figure 2-26 shows a thermocouple switch test.

1. Set the applicable software options:
 - The TC is set to source a temperature
 - The UTILITY is set to SWITCH TEST. The AUTOMATION is set to RAMP
2. Complete the electrical connections.
3. It is a CH1 function, the switch connections must be on CH2.
4. For the Ramp process, set START and STOP values that are applicable to the switch value.
5. To get an accurate switch value, set a long TRAVEL period.

6. Use  to start the "Ramp" cycle.
7. Use  to stop the "Ramp" cycle.
8. If necessary, supply the output values in the opposite direction until the switch changes condition again.
9. The display will show the following:
 - Values for switch Open and switch Close Points
 - Hysteresis value

Opened at	8.0264
Closed at	6.0082
Hysteresis	2.0183

10. To do the test again press the  button.

2.14 Measure Pressure: IDOS Option

Optional item. An IDOS Universal Pressure Module (UPM) uses Intelligent Digital Output Sensor (IDOS) technology to measure the applied pressure and supply the data to an IDOS instrument. Before using an IDOS module, (Ref: User Manual: K0378, Druck IDOS UPM).

Note: To attach an IDOS module to the Druck DPI 620 Genii calibrator use an IO620-IDOS-USB adaptor.

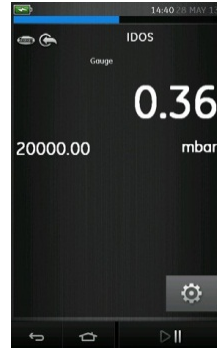
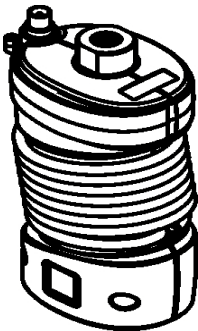

2.14.1 IDOS Option Assembly Instructions

Step	Procedure
1.	Attach one end of the adaptor IO620-IDOS-USB to the IDOS module
2.	Push the Type A end of USB Cable into the USB socket on the instrument and the type B end into the adaptor (IO620-IDOS-USB)
3.	Set the instrument power on
	When this symbol flashes at the top of the display, it shows there is communication between the IDOS module and the calibrator

2.14.2 IDOS Function Procedures

Set the calibrator functions for use on the display.

This includes:

- IDOS function (to measure the pressure)
- If necessary, change the Units for the function
- If necessary, set a Utility for the function:
 - i Max/Min/Avg
 - ii Switch Test
 - iii Leak Test . The procedure is the same for an IDOS module or for a MC 620/PM 620 assembly.
- If necessary, change the Settings for the IDOS function:
- Process (Tare, Alarm, Filter, Flow, Scaling)
 - i Leak Test (Only when the Utility is set). The procedure is the same for an IDOS module or for a MC 620/PM 620 assembly.
 - ii Zero. The procedure is the same for an IDOS module or for a PM 620 module. Zero the gauge sensor before use.
- Continue with the pressure operation.

2.15 Error Indications

Under range:

The display shows this symbol for this condition:

<<<<<

Reading < 102% Negative Full Scale

Over range:

The display shows this symbol for this condition:

>>>>>

Reading > 102% Positive Full Scale

If the display shows <<<< (under range) or >>>> (over range):

- Make sure that the range is correct.
- Make sure that all the related equipment and connections are serviceable.

3 Pressure Indicator Operation (MC620)

This section gives examples of how to connect and use the instrument to measure pressure with the module carrier (MC 620) and the applicable pressure modules (PM 620).



Figure 3-1 MC620G

To make a fully integrated pressure calibrator instrument with one of the three Pressure Stations, refer to the User Manual for the PV62x Series of Pressure Stations, K0457.

CAUTION

To prevent damage to the PM620 module, only use it within the specified pressure limit on the label.

When the items are attached to the Druck DPI 620 Genii it is a fully integrated pressure indicator, measuring pneumatic or hydraulic pressure.

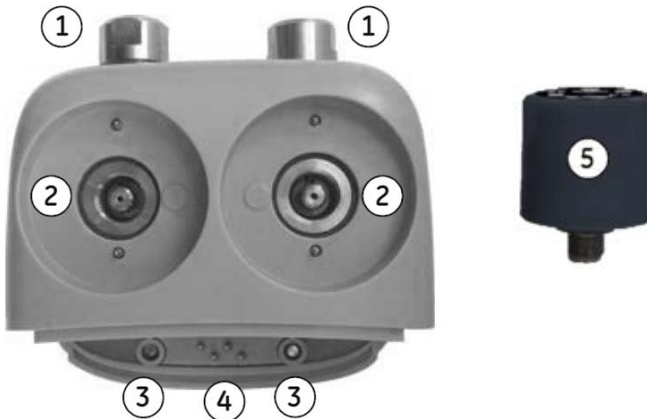

Figure 3-2 MC620G and PM620G Part Identification

3.1.1 Assembly Instructions

Step	Procedure
1	Align the two slots (a) on the calibrator with the two posts (b) on the module carrier.
2	When the posts are fully engaged in the slots, tighten the two screws (2) hand-tight.
3	Attach one or two PM 620 modules (4) with the correct range and type.
4	Tighten each PM 620 module (4) hand-tight only.
5	When the  symbol flashes at the top of the display, there is communication between the module and the calibrator.



Figure 3-3 MC620 Assembly Procedure

3.2 Pressure Connections

WARNING

Pressurized gases and fluids are dangerous. Before attaching or disconnecting pressure equipment, safely release all the pressure.

The pressure ports for external equipment use “Quick fit” pressure adaptors. (Refer to Figure 3-4).



Figure 3-4 Quick Fit Pressure Adaptor

3.2.1 Procedure (Attaching External Equipment)

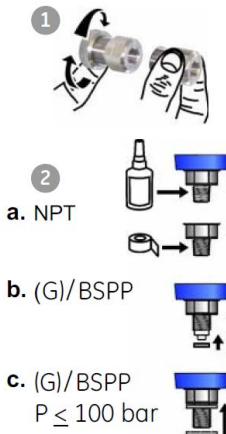

Figure 3-5 Pressure Connections

Step	Procedure (refer to Figure 3-5)
1	Remove the adaptor from the pressure port.
2	Use an applicable seal for the pressure connection: <ol style="list-style-type: none"> <li data-bbox="319 459 964 526">a. NPT type: Use an applicable sealant on the thread. <li data-bbox="319 529 964 596">b. BSP (parallel) type: Use the applicable bonded seal at the bottom. <li data-bbox="319 600 964 678">c. BSP (parallel) type, 100 bar (1500 psi) or less: a bonded seal at the top is permitted.
3	Attach the adaptor to the external equipment. If necessary use an alternative adaptor.
4	Tighten to the applicable torque.
5	Attach the adaptor to the MC 620 carrier and hand-tighten.

When the pressure indicator assembly is complete use the menus to set-up the necessary operations. (refer to Section 3.3).

3.3 Procedure Overview

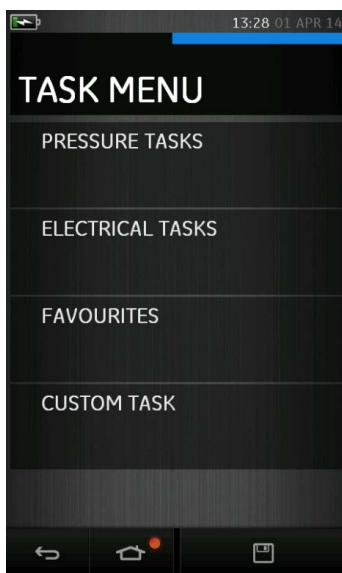

Figure 3-6 Task Menu

When PM620 Pressure modules are fitted, **PRESSURE TASKS**, are available in the **TASK MENU**. Refer to Section 2.1 Basic Calibrator Operation for details.



Figure 3-7 Pressure Tasks

Select the required function by selecting on either the appropriate text or diagram. The DPI620G will set the functions and return to the CALIBRATOR screen.

Pressure Functions can also be selected through the CUSTOM TASK function. Refer to Section 2.1.4 for details.

Tasks can be SAVED or COPIED into the FAVOURITES. Refer to Section 2.1.1 for details.

If required, change the Units or the function. If necessary, set a Utility for the function:

- Max/Min/Avg
- Switch Test
- Relief valve
- Leak Test



Figure 3-8 Channel Settings

Note: **UNITS** and **UTLILITIES** are accessed through selecting the function through **CUSTOM TASK**.

3.4 Set up a Leak Test

 This utility is only available in Pressure Measurement modes.

This utility provides a test to calculate the leak of a system.



Figure 3-9 Leak Test Example

To configure leak test:

1. Set the Utility to Leak Test.
2. Select:

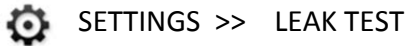



3. Set the following periods

WAIT TIME:

The time before the test starts in hours:minutes:seconds (hh:mm:ss).

TEST TIME:

The period of the leak test in hours:minutes:seconds (hh:mm:ss)

4. Use  to start the Leak Test
5. Use  to stop the "Ramp" cycle

Note: To set the Leak Test options, a pressure module must be correctly installed.

3.5 Set the Pressure Module to Zero



SETTINGS >> ZERO >> ZERO

Use this option to write a new zero pressure value to the pressure module in use. The sensor adjustment is permitted if it obeys the condition that follows:

- Adjustment $\leq 10\%$ FS positive pressure value (for the Sensor).

Note: To make a temporary adjustment for zero, use the Tare function.

3.6 Error Indications

Under range:

The display shows this symbol for this condition:

<<<<<

Reading < 110% Negative Full Scale

Over range:

The display shows this symbol for this condition:

>>>>>

Reading > 100% Positive Full Scale

If the display shows <<<< (under range) or >>>> (over range):

- Make sure that the range is correct.
- Make sure that all the related equipment and connections are serviceable.

4 Data Logging Operation

Select the  DATA LOGGING option on the Dashboard. The Data Logging function records instrument readings so they can be reviewed or analysed.

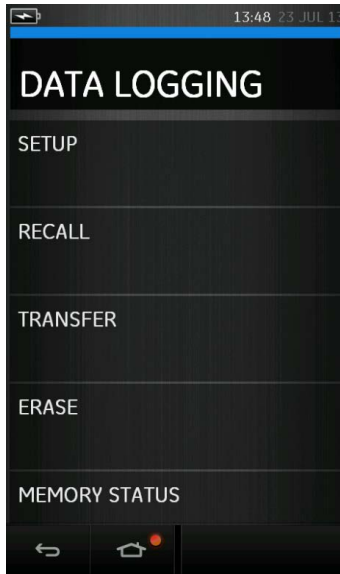

Figure 4-1 Data Logging

The data file can be reviewed by using the following:

- Recall

The data file can be processed externally by using the following:

- Transferred to a USB Flash Memory Device
- Transferred to a computer

This chapter describes how to use the Data Logging function to log data to a file.

In Data Logging mode the display data from all active channels is stored at each data point. The data can be stored:

- Periodically
- Key press

The data is stored in the internal memory or on an SD card until the Data Logging is stopped. When Data Logging has stopped, data can be automatically transferred to a USB Flash Memory Device.

4.1 Set-up

Before starting, set all channels to the correct functions. (Refer to section 2.1). To access the Data logging function do the following:

DASHBOARD >>  DATA LOGGING >> SETUP

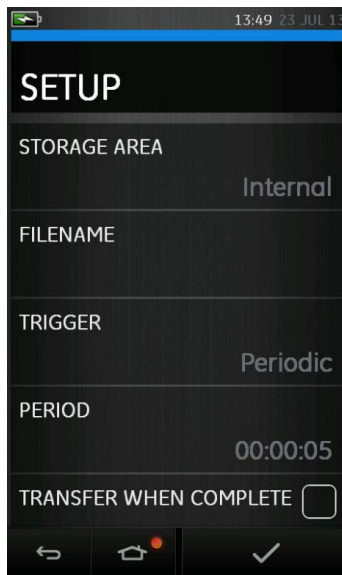

Figure 4-2 Datalogging Setup

- **STORAGE AREA**

Used to set Internal or SD card storage. Only the SD card can be read when connected to a PC.

- **FILENAME**

Enter the filename (10 characters maximum)

- **TRIGGER**

Select one of the following:

- Key Press (logs one data point each time the button is pressed)
- Periodic (logs one data point at a set time interval)

- **PERIOD**

Used to set the time interval for periodic data logging

- **TRANSFER WHEN COMPLETE**

Used to transfer data to a Flash Drive

To start Data Logging Mode:

1. Select appropriate options and enter filename for Data Log file.
2. Select the  button.

4.2 Operation

In periodic mode, to begin data logging tap 'Start logging' button. 

In Key press mode, a data point is taken every time the user taps the log button. 



To stop Data Logging select . 

The data logging indicator  flashes to indicate whenever a reading is logged.

4.3 File Review

DASHBOARD >>  DATA LOGGING >> RECALL

To view a data file point by point do the following:

1. Tap the Filename button to display the list of data files.
2. Select the file to be displayed.
3. Tap  to see the data display.
4. To step the display one data point, tap the Next Log button. 

Note: The data point number sequence is displayed in the top right-hand corner (e.g. 4 of 100).

5. To go back one data point, press the Previous Log button. 
6. Exit the screen.

4.4 Chart View

DASHBOARD >>  DATA LOGGING >> RECALL

To view a data file on a chart do the following:

1. Tap the Filename button to display the list of data files.
2. Select the file to be displayed.
3. Select VIEW CHART

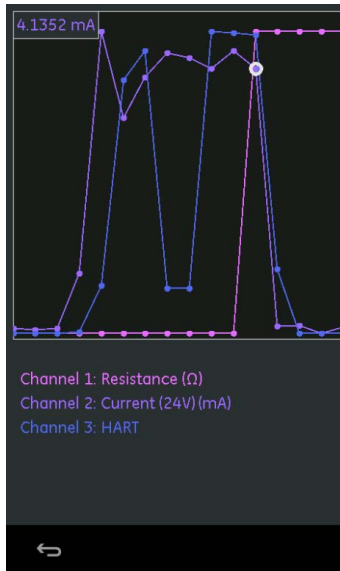

Figure 4-3 Datalog Chart

Selecting Individual Points will highlight selected value.

4.5 File Management

The data log file management options are as follows:

- **TRANSFER** : Upload data log files to another computer.
- **ERASE**: Delete data log files.
- **MEMORY STATUS**: Displays amount of free memory.

4.5.1 Transfer

Data may be transferred as follows:

- **USB Flash Memory Device**: Selected files are written in the root folder of the USB Flash memory Device.
- **SD card**: Data logged in an internal storage area can be transferred to the SD card storage area.
- **USB Serial Port**: Transfers data as a text file to a computer. A communications program can be used to receive the data (e.g. Microsoft® Hyper Terminal). The serial set-up is as follows:

Baud rate - 19,200 bits/sec

Data bits - 8

Parity - none

Stop bits -1

4.5.2 Erase

The Erase options are as follows:

- **ERASE ONE FILE:** Select file and tap tick bottom right on the screen to erase.
- **CLEAR INTERNAL:** Clears all internal files.

4.5.3 Memory Status

The **MEMORY STATUS** button will show the amount of available memory in the areas that follow:

- Internal
- USB Flash Memory Device (if fitted)
- SD card

4.6 Data Format

The data files are produced in a Comma Separated Variable (csv) format (refer to Figure 4-4).. This allows the data to be imported into a spreadsheet (e.g. Microsoft® Excel). The first section of the data file contains the following:

FILENAME - The data file name
 COLUMNS - Information for internal use
 START - Datalog start time
 VERSION - Data format version
 CHANNEL - The function setting of each active channel

The second section of the data file contains the following:

Individual headings
 Data point data

```
FILENAME,P080821A
COLUMNS,3,9
START,21 Aug 2008, 21:38:59
CHANNEL 001, Current (24V), In,mA,55
CHANNEL 005, HART, In,,0
DATA,START
ID,Date,Time,Main Reading,Secondary Reading,
0,21 Aug 2008, 21:39:14,8.7525,24V,4,0,False
1,21 Aug 2008, 21:39:29,8.5711,24V,4,0,False
2,21 Aug 2008, 21:39:44,8.4080,24V,4,0,False
3,21 Aug 2008, 21:39:59,8.2475,24V,4,0,False
4,21 Aug 2008, 21:40:14,8.0733,24V,4,0,False
5,21 Aug 2008, 21:40:29,7.9288,24V,4,0,False
```

Figure 4-4 Example .csv Datalog File

5 Documentation

This chapter describes the Documenting functions available with the Druck DPI 620 Genii calibrator and are as follows:

- ANALYSIS
- RUN PROCEDURE

5.1 Analysis

The Analysis function takes readings from two or more DPI 620 channels to calibrate the transfer characteristic of the device being tested. One channel is the Reference channel and is used as follows:

- Provides a measure of the input signal to the device.
- If calibrating a temperature transmitter the Reference channel could be CH1 in either RTD or TC source mode.
- If the device is a pressure transmitter the Reference channel would be P1 or P2 measuring the input pressure to the device.

The other channel is the Input channel and is used as follows:

- Measures the output signal from the device
- If calibrating a process transmitter it could be CH2 in Current Measure mode.



A second input channel can also be used, to calculate the transfer characteristic between three points in the signal path and may be calibrated at the same time, as in the example that follows.

- When calibrating a process transmitter that is HART® enabled the second input channel could be the HART® channel. The HART® channel reads the Primary Variable (PV) value from the sensor in the process transmitter this would allow the pressure sensor to be calibrated at the same time as the current loop output.

Any active channel that is not defined as Reference is Input by default.

There must be one Reference channel and at least one Input channel defined for the Analysis function set-up to be correct.

At each value the Analysis function calculates the difference of each Input channel to the ideal transfer characteristic and compares this to a tolerance limit.

- The deviation is shown in %Span or %Rdg
- The tolerance test result is shown a Pass  or Fail  icon.

5.2 Set-up

1. Set the Druck DPI 620 Genii channels in the Calibrator function. (Refer to section 2.1).
2. Connect the calibrator to the device under test.
3. Enter the Documenting function.

DASHBOARD >>  DOCUMENTING

4. Tap the ANALYSIS button.

5.2.1 Define the Reference Channel

1. Tap the channel button that is to be used as the Reference channel for the analysis.

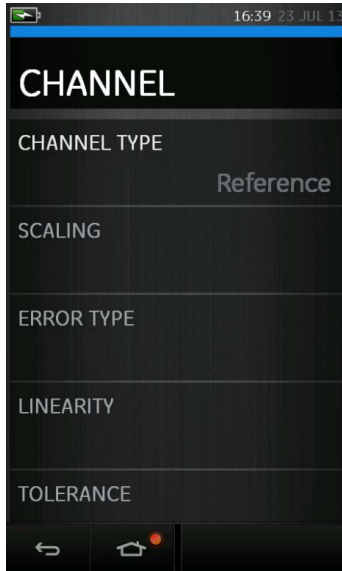

Figure 5-1 Select Reference Channel

2. Set the channel type to Reference.
3. All other channel settings for that channel are cancelled. All other active channels are set to Input.

5.2.2 Define each Input Channel

Tap each Input channel button to set the Input options.

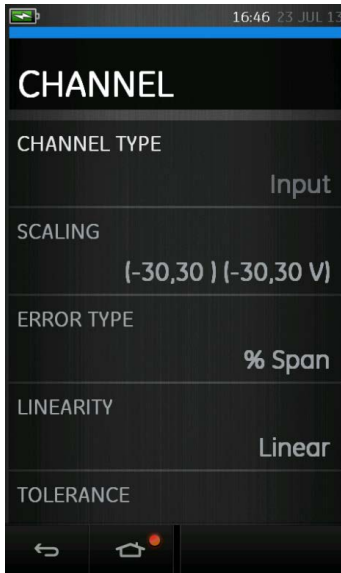

Figure 5-2 Select Input Options

- **SCALING** - The scaling values are four set values:
The maximum and minimum Reference signal values (Reference High and Reference Low).
The Input signal values (Input High and Input Low).
The Input signals should relate to the Reference signal values with a linear or square root transfer characteristic.

- **ERROR TYPE** – The deviation from which the transfer characteristic is to be calculated. This can be one of the following:
 - % Span** - a percentage of the Input signal span.
 - % Rdg** - a percentage of the Input signal reading.

- **LINEARITY** - The transfer characteristic from Reference to Input signal. This can be one of the following:
 - Linear** - a proportional response.
 - Square Root** - often found in flow sensors.

- **TOLERANCE** – The test limits for the deviation from the transfer characteristic.



5.3 Analysis Function

Set Input channel parameters (refer to section 5.2), and return to CHANNEL SETUP screen.

Select the Start button 

The Analysis window displays the following:

- The deviation of each Input channel from the ideal transfer characteristic.
- A tolerance limit test icon

Pass  (within tolerance test limit)
Fail  (outside tolerance test limit)

To check the full range of the device do the following:

1. Step the Reference signal value through its range.
2. Check the Analysis window at each step.
3. If the Reference is sourced from the calibrator, move to the channel window to change the Reference value.
4. Return to the Analysis window.
5. When the analysis is complete exit the window by selecting exit .



5.4 Run Procedure

The purpose of the Run procedure is to do calibration procedures which have been downloaded from 4 Sight software. The 4 Sight calibration procedure contains all the values to calibrate a device under test (test points, ramp time).

The same calibration procedure can be used for all the applicable devices under test. To use the Run Procedure function, the following items are required:

- A copy of the 4 Sight Calibration Software.
- Standard USB lead (as supplied).
- A Druck DPI 620 Genii calibrator device driver available as a download from the website www.ge-mcs.com.

5.4.1 Sequence to Upload and Download File

Step	Procedure
1.	Connect Standard USB lead (as supplied) to the Druck DPI 620 Genii calibrator.
2.	Connect the lead to the USB port on the computer that has the calibrator manager installed.
3.	Use 4 Sight to set-up the procedure and create a work order for the device. The procedure includes the parameters for the calibration, the number of test points, the relationship and pass/fail tolerance.
4.	Use the Download button in calibrator manager to Download the file to the Druck DPI 620 Genii calibrator. A communications symbol will be displayed at the bottom of the screen.
5.	Select DASHBOARD >> DOCUMENTING >> RUN PROCEDURE
6.	In the Results window, select the filename specified in calibrator manager.
7.	Enter the User ID and the DUT Serial Number.
8.	Tap on the Start button  . The Procedure sets up the necessary Channel options e.g. mA and Volts.
9.	Use the Take Reading button at each point specified by the procedure. A prompt shows for each point.
10.	When all the readings are complete, tap on the Exit Button  . Look at the results on the display (As found/As Left).
11.	To complete the process, use the calibrator manager to Upload the file back into the 4 Sight database

6 HART® Operations

The Druck DPI 620 Genii can communicate with devices that use the HART® protocol as follows:

- The Universal and Common Practice commands specified in HART® revision 5 to 7.
- Devices that support Device Descriptions (DD).

This section includes procedures to use the HART functions available in the calibrator.

6.1 HART® Menu Operations

The HART® application is started from the Dashboard. The HART® uses a digital signal on top of a standard 4 - 20 mA current loop to get data to and from a HART® enabled field device. Typical operations include the following:

- Read the primary variable and the analogue output.
- Read the device serial number, type and supplier.
- Get calibration data (upper and lower range values, sensor limits, calibration date).
- Do status and fault finding checks.
- Change the device configuration (range, units, damping).

The Druck DPI 620 Genii can be used to communicate with other HART® field devices as follows:

- As a **Primary Master** the Druck DPI620 Genii starts and controls all communications. The field device (slave) uses each command from the master device to make a change and/or send data back.
- As a **Secondary Master** the Druck DPI620 Genii is connected into an existing HART® communications network. The Secondary Master communicates with the field device in between Primary Master messages.

6.2 Start-up

HART® communication is started by selecting:

DASHBOARD >>  HART

Task can be selected for CH1, CH2, P1 and P2. Refer to Section 2.1.

HART® can also be selected from the CALIBRATOR  function.

Select:  COMMUNICATOR channel from TASK SETTINGS

FUNCTION >> HART

6.3 HART® Connections

Before setting-up the electrical connections between the HART® device and the Druck DPI 620 Genii get the correct connection scheme (Ref: DASHBOARD >> HELP).

6.4 Power Supply from the Calibrator

A 24 V or 28 V loop power can be supplied using the CH2 Current (24V) measure function.

In the example that follows, the Druck DPI 620 Genii supplies the loop power and a 250 Ω HART® resistor.



Figure 6-1

6.5 External Loop Power

In the example that follows, there is an external power supply.

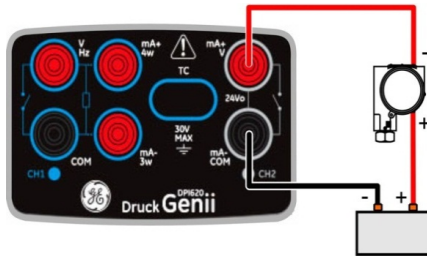

Figure 6-2

Measure current on CH2 without 24 V loop power.

HART® function is enabled and 250 Ω resistor is enabled.

6.6 Communicator Attached to a Network

In the example that follows, the calibrator connects directly to a network. There must be a 250 Ω resistor in series with the loop power supply and the HART® device.

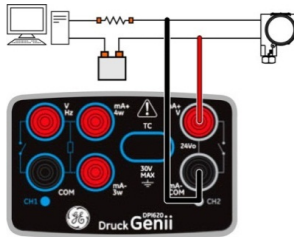

Figure 6-3

CH2 function is set to None. HART® function is enabled and 250 Ω resistor is set to Off.

6.7 Use of Test Connections

Use the test connection with a HART® transmitter. Use CH1 to measure current and CH2 to communicate with the HART® device. CH2 must be set to None, and CH1 must be placed into current measure mode. There must be an external HART® resistor in the loop.

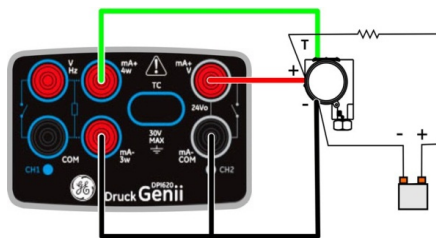

Figure 6-4

6.8 Viewing Primary Variables

When connected to a HART® device, the Primary Variable value and PV units will be displayed in the channel window.

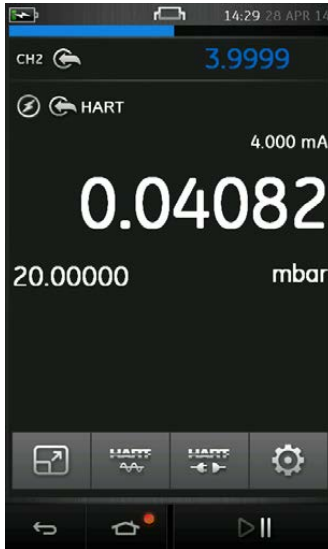



Figure 6-5 Primary Variables

6.8.1 Device Polling

The connected HART® device may be configured with a unique Poll Address. If the PV is not displayed then the Device Polling Scheme should be set as follows:

-  Settings >> DEVICE POLLING
 - Select Poll Address and scheme “Use Poll Address” to

use a specific Poll Address.

- Select “Find First Device” to search from 0 to 63 and use the first device found.
- Select targeted address ranges to select from a range of devices at poll addresses.

6.8.2 Viewing HART® Configuration

To view an overview of the HART® configuration (e.g. Tag, URV, LRV, etc.) select:



Settings >> VIEW HART CONFIG

6.9 Start HART® SDC Application

1. Select the HART® channel so that it is in its expanded view (refer to Section 2.3)
2. Select  button



Figure 6-6 Hart Channel Window

The Main HART® SDC application will now open.

The Druck DPI 620 Genii displays the HART® SDC application screen in light or dark mode.

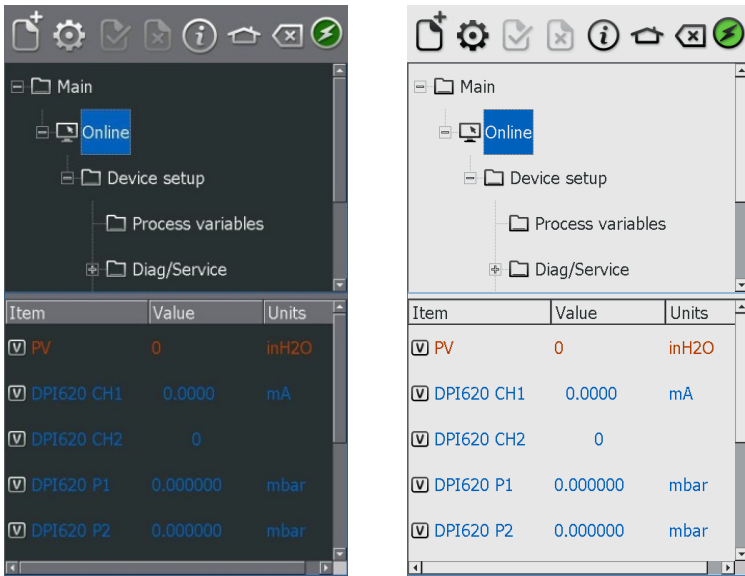

Figure 6-7 HART® Application Main Screen







6.10 HART® Toolbar





Figure 6-8 HART® Toolbar

On entering the HART® SDC application, the toolbar is displayed. The ICONS are greyed out when they are not active.

The ICON functions are described below:

-  **OPEN NEW CONNECTION** – Requires HART® application to Exit and Restart from Dashboard.
-  **CLOSE** – Closes down connection and returns to Channel Window
-  **PREFERENCES** – Selection of Search Options (Poll Address / Short and Long Tags)
-  **COMMIT** – Commit updated values back to the device (refer to Section 6.12)
-  **ABORT** – Abort Update of parameters, reverts to previous values (refer to Section 6.12)
-  **STATUS** – Field Device Status and HART® operations summary.
-  **HOME** – Return to Dashboard. Minimizes HART® application.

-  DEVICE COMMUNICATIONS ON.
-  DEVICE COMMUNICATIONS STARTING.
-  DEVICE COMMUNICATIONS FAILED.

6.11 Data Display

The display data is colour coded as follows:

- **Red** - HART® transmitter data
- **Blue** - Druck DPI 620 Genii channel data
- Black/White - can be edited

Common acronyms used are as follows:

- PV - Primary Variable
- AO - Analogue Output
- URV - Upper Range Value
- LRV - Lower Range Value
- USL - Upper Sensing Limit
- LSL - Lower Sensing Limit

The data display also shows the current readings of the DPI 620 Genii instrument channels. This is used in calibration procedures.

6.12 Editing Values

Any value displayed in white/black with a [V] or [E] icon can be edited. Edit variables as follows:

1. Select the variable
2. If a selection window is opened select the variable (or select Edit button).

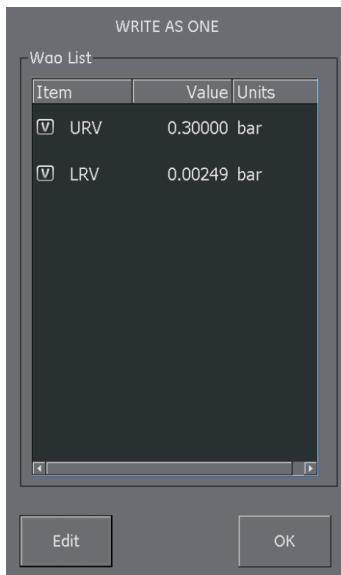



Figure 6-9 Hart Write Variable Selection

3. Enter a new value
4. Select the Set button
5. Select OK button to return to main application screen.
6. The new value is highlighted in yellow

Note: *To go back to the original value, select the Abort button  in the menu bar.*

7. Select Commit button  in the menu bar to implement a new value
8. The yellow highlight will disappear.

6.13 Executing Methods

Not all HART® devices have the same methods available.

The function, purpose and execution of each method can be different. Methods may include the following:

- Self-test
- Loop test
- Sensor trim
- D/A trim

Execute a method as follows:

1. Select the method name. A screen opens with information about the selected method. Four buttons are displayed on the screen:

HELP Displays a description of the method.

ABORT Exits from the procedure.

OK Accepts inputs and proceeds to the next step.

SWITCH APP: Returns to Druck DPI 620 Genii screen (to change channel function settings without interrupting the method procedure).

Note: Some methods may make the HART® device output a certain current.

A warning will appear on the screen before the device enters this mode.

2. Some methods need values to be entered. Use the alpha/numeric keypads.
3. A drop down menu can be used for method selection options.
4. Some methods require input from the DPI 620 instrument channels. A drop down menu displays the channels as follows:
 - CH1
 - CH2
 - P1
 - P2
 - IDOS
5. On completion the procedure will return to the HART® application. If required use the Abort button.

6.13.1 Method Example - Self-test

1. To confirm that the transmitter is functioning correctly, navigate to the Test device folder.
2. Select the Test device folder.
3. Select OK.

The self-test executes.

6.13.2 Method Example - Analog Trim

The Druck DPI 620 Genii can perform an analogue trim on the 4 to 20 mA loop without connecting to any external reference meters.

1. Navigate to the calibration folder

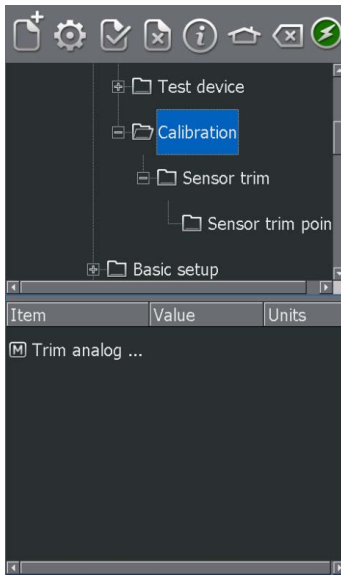

Figure 6-10 Calibration Folder

2. Select Trim analog method.
3. Follow the on-screen instructions. If channel 2 is set to Measure Current (24V), this can be used to supply the reference meter value.

4. Read the CH2 value and enter this in the meter value text box using the keypad.

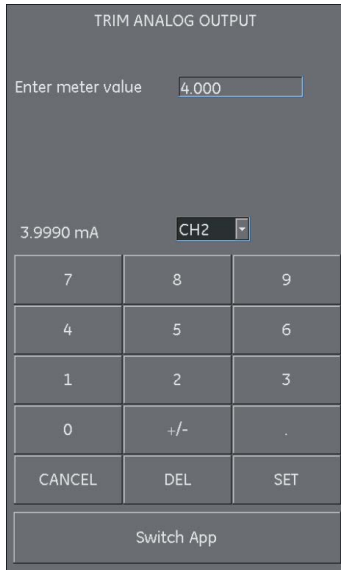

Figure 6-11 Enter Calibration Point

5. Select SET.
6. Repeat steps 3 and 4 with 20 mA selected. This will calibrate the transmitter's output current.

6.14 Preferences

Select the Preferences icon  to setup the HART ® device search method.

The application allows searching by:

- Poll Address - when each transmitter has a unique address.
- Short tag - if the transmitter supports 8 character tags.
- Long tag - if the transmitter supports 32 character tags.

Transmitters with a non-zero poll address are in multi-drop mode and default to a fixed loop current of 4 mA.

By default, the Druck DPI 620 Genii polls address 0 (zero) only. Change the Poll Address by selecting the appropriate search radio button or entering the tag name in the search field.

6.15 Failed to find Device

Fault	Possible Cause	Action
Failed to find device	Power Supply	Check device is turned on. Check applicable fuses. Check the supply voltage is within limits.
	Device under test	Check device is HART® compatible. Connect multiple devices one at a time.
	Circuit	Check circuit connections. Check circuit Continuity. Check correct polarity of supply to the transmitter. Check the HART® resistor is in the correct place in the loop. Check the HART® resistor has the correct value. Check the loop current is in the range 3.5mA to 24mA.
	Druck DPI 620 Genii	Check the Druck DPI 620 Genii is connected to the correct points in the loop. No external HART® resistor present, check the internal resistor setting. External HART® resistor present, check the DPI 620 resistor setting is OFF. Check that the CH 2 function is set to 'NONE' if the Druck DPI 620 Genii is used as a secondary master (in parallel with an external supply).
	Preferences	Select the 'search 0-63' option to scan all possible Poll Addresses to get the Poll Address and Tag details of the connected device.

7 HART® Offline

7.1 Introduction

The HART® Offline feature sits alongside the existing HART® application to provide extended offline capabilities. Typical operations include the following:

- Connect to a HART enabled device to view its configuration and save to file.
- Full configuration is supported for all commands (universal/common & device specific)
- All devices available in HART library are supported
- Amend configuration files
- Work offline to create configuration files
- Upload configuration files to HART devices
- Export configuration files (to USB stick)
- Import configuration files on PC for viewing offline

7.2 Start-up

Refer to Sections 6 for details of configuring the HART® function settings.

7.3 Start HART® Offline

1. Select the HART® channel so that it is in its expanded view (refer to Section 2.3)
2. Select HART offline button 



Figure 7-1 Hart Channel Window

The HART® offline feature will be presented.



Figure 7-2 HART Offline Main Menu

On first use, an empty menu will be presented. Once Offline Configurations have been created, they will be listed in this menu (most recent first).

7.4 Create an Offline Configuration

An offline configuration can be created either when *connected* to a device or *disconnected*.

7.4.1 Connected Configuration

Press the New Configuration button 

Details of the connected device will be displayed:

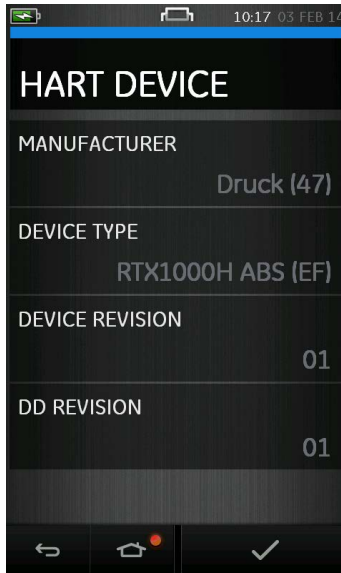



Figure 7-3 Device Details

Press the  button to continue.

7.4.2 Disconnected Configuration

Press the New Configuration button 

Select from the menu the device details that you want to configure.

Press the  button to continue.

7.5 Edit an Offline Configuration

Having created an offline configuration (either connected or disconnected) the HART Commands menu will be displayed.

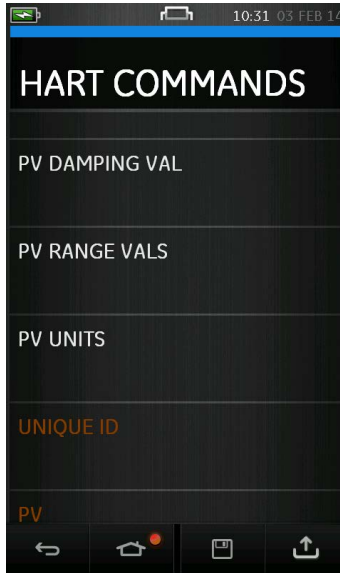

Figure 7-4 Commands

Read/write commands appear at the top of the list.

Read only commands appear at the bottom of the list and are coloured red.

Selecting a Command will display a list of Variables relevant to the Command.

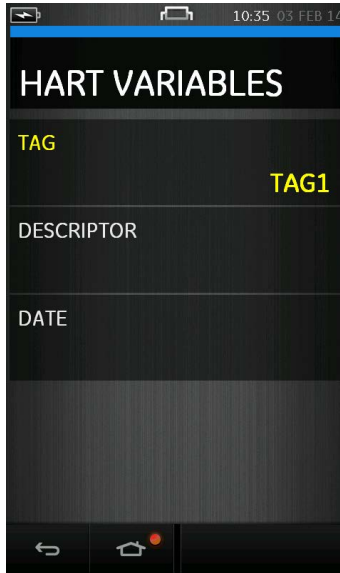



Figure 7-5 Variables

When connected, the Variables will be populated with values from the device.

When disconnected, the variables are populated by the user.

When a Variable value has been edited it will be displayed in **yellow**.

Pressing the Back button  will return back to the Commands menu. Any changes to Variable will also be reflected in the Commands menu (also in **yellow**).

7.6 Saving the Configuration

From the Commands menu, the configuration may be saved by pressing the Save Button 

The device name will be used as the default file name.

Having saved the configuration, the main Offline menu will be presented with the new configuration file first in the list.

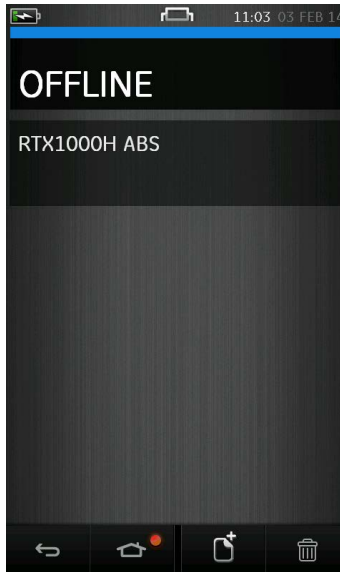



Figure 7-6 Main Menu with Configuration File

7.7 Uploading the Configuration

From the Commands menu, the configuration may be uploaded to connected device by pressing the Upload Button 

7.8 Working with Saved Configurations

Selecting a Saved Configuration from the main Offline menu enables the user to perform the following operations:

7.8.1 Open HART Config

This enables a previously saved HART configuration file to be edited.

7.8.2 Upload Config to Device

This enables a previously saved HART configuration file to be uploaded to a connected device.

7.8.3 Copy HART Config to USB

This enables a previously saved HART configuration file to be saved to a USB memory stick. The USB memory stick should be inserted into the DPI620 Genii prior to selecting this option.

Once copied to the USB memory stick, the HART configuration file can be modified, copied or cloned on a user's PC.

7.8.4 Delete HART Config

Deletes the HART configuration file from the DPI620 Genii.

7.9 Further Operations

7.9.1 Delete All Configuration Files

From the main offline menu, all saved configuration files may be deleted by pressing the Delete All Button. 

7.9.2 Import Configuration Files from USB Memory stick

Insert a USB memory stick containing saved configuration files. From the main offline menu press the New Configuration Button. 

WARNING: Any files on the DPI620 Genii with the same name as files on the USB memory stick will be overwritten.

8 Foundation™ Fieldbus

8.1 Introduction

FOUNDATION™ Fieldbus (FF) is a device application for configuration of FF enabled field devices. On-line connection is via the integrated H1 modem. Devices directly connected to an H1 field segment can be configured and supported by FF.

8.2 Start up

FOUNDATION™ Fieldbus is started by selecting:

DASHBOARD >>  FIELDBUS

Task can be selected for CH1, CH2, P1 and P2. Refer to Section 2.1.

FOUNDATION™ Fieldbus can also be selected from the  CALIBRATOR function.

Select:  COMMUNICATOR channel from TASK SETTINGS
FUNCTION >> FIELDBUS

Note: When Fieldbus is operational, only Volts measure is a valid mode for channel 2.

To start the FOUNDATION™ Fieldbus application and connect to a device:

1. Connect DPI620 Genii to a H1 FOUNDATION™ Fieldbus device.

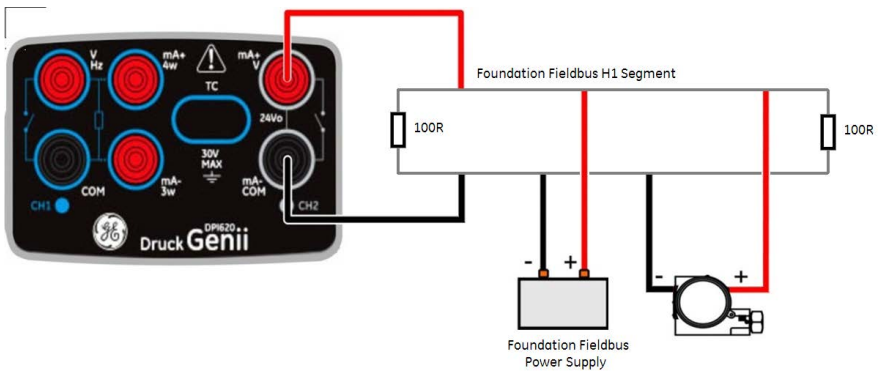

Figure 8-1 Example Connection Diagram Foundation Fieldbus

2. Select the FOUNDATION™ Fieldbus channel so that it is in its expanded view (refer to Section 2.3).

3. Select  button.

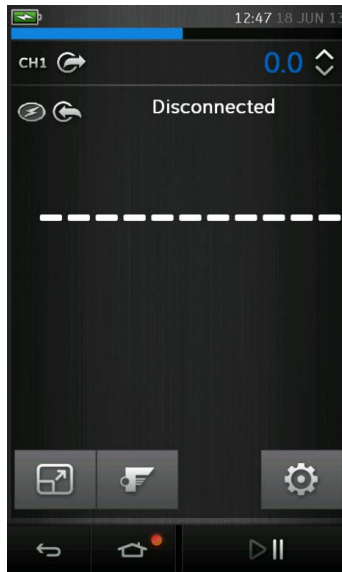



Figure 8-2 Calibrator Fieldbus Channel

4. The Main FOUNDATION™ Fieldbus application will now open.

Note: Updating CH1, CH2, P1, P2 tasks is only possible when the FOUNDATION™ Fieldbus application is not running – to close FOUNDATION™ Field bus application select :

 HOME >> Exit (refer to Section 8.3)



8.3 FOUNDATION™ Fieldbus Toolbar



Figure 8-3 FOUNDATION™ Fieldbus Toolbar

On entering the FOUNDATION™ Fieldbus application, the toolbar is displayed. The ICONS are greyed out when they are not active.

The ICON functions are described below:







 **OPEN CONNECTION** – Only available when awaiting an open connection. (When navigating devices **OPEN CONNECTION** is replaced by the **CLOSE** icon. )

 **CLOSE** – Only available in Navigation Tree (refer to Section 8.6) and Functional Group View (refer to Section 8.7).

Closes down connection and returns to Device Focus View (refer to Section 8.5).

 **SETTINGS** – Application configuration settings and DD library details (refer to Section 8.11).

 **COMMIT** – Commit updated values back to the device (refer to Section 8.7.3).

-  **ABORT** – Abort Update of parameters, reverts to previous values (refer to Section 8.7.3).
-  **STATUS** – Provides Device profile of currently connected device (refer to Section 8.5).
-  **FUNCTION FINDER** – Search FF variables and device functions.
-  **HOME** – Return to Main Application. Allows user to either **MINIMISE** or **EXIT**. (If **FOUNDATION™** Fieldbus readings are to be referenced in Main Application then **MINIMISE** should be selected).
-  **DEVICE COMMUNICATIONS OFF**. Indicator Only.
-  **DEVICE COMMUNICATIONS ON**. Indicator Only.

8.4 Scanning For Devices

The following steps describe how to scan for FOUNDATION™ Fieldbus devices over a FOUNDATION™ Fieldbus H1 connection:

1. Connect DPI620 Genii to H1 bus (refer to section 8.2).
2. Select the **OPEN CONNECTION** icon  on the Toolbar to enter device scan screen.

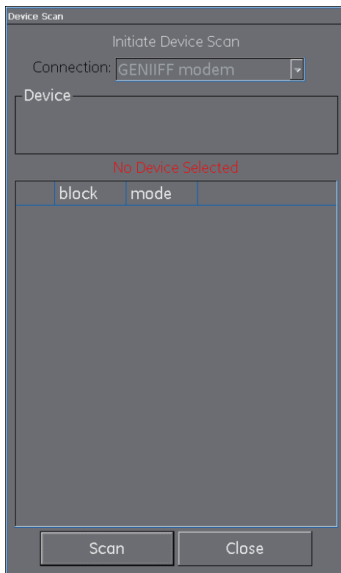

Figure 8-4 Device Scan Screen

3. Select the SCAN button

The 'scanning' progress dialog view will open. Any devices found in the selected range will appear in the bus tree window list - All scanned devices are shown as a bold icon with an associated tag. Previous scan results are indicated in grey.

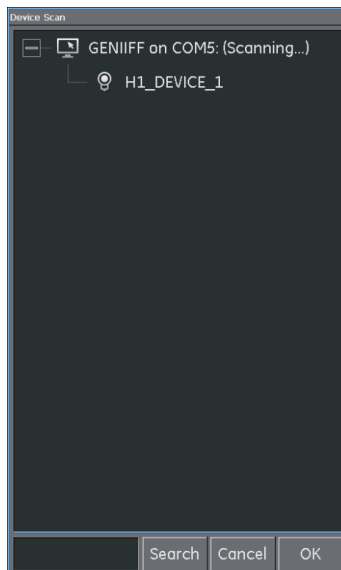

Figure 8-5 Device Scan View

Note: The scan may be stopped at any time by selecting the **CANCEL** button. If cancelled the current scan results are retained.

A search term can be entered into the **SEARCH** dialog to look for a specific device in the discovered scan list.

4. Selecting any device in the search results and selecting **OK** will initiate connection to the 'Device Focus view.'
5. To Re-scan use the context sensitive menu on the Genii Modem (Refer to section 8.4.1).

8.4.1 Context Sensitive Menu

Context sensitive menus are available for each device in the scan Menu by select and hold.

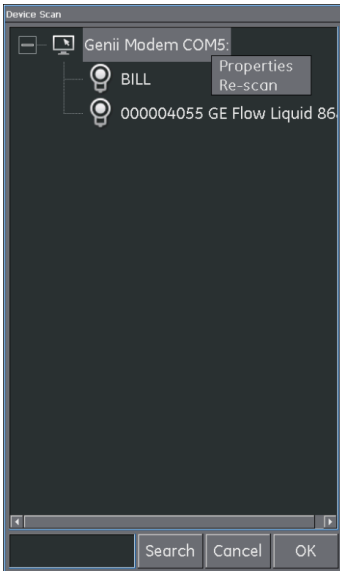

Modem

This provides access to the following functions:

- Properties (Displays modem profile)
- Re-Scan

Figure 8-6 Scan Menu - Context Sensitive - Modem

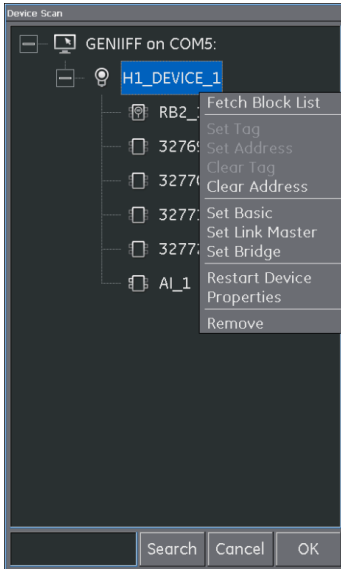

Figure 8-7 Scan Menu - Context Sensitive - Device

Devices

This provides access to the following functions:

- Tag / Address Change
 - Set Tag
 - Set Address
 - Clear Tag
 - Clear Address
- Boot Operational Function (BOF) class change
 - Set Basic
 - Set Link Master
 - Set Bridge
- Restart Device
- Properties (Displays device profile)
- The device Block List can also be fetched from here (Default functionality is to use "Device Focus View" refer to section 8.5)

8.4.2 Troubleshooting

- If no device is found when performing scan check:

Field wiring. Verify electrical segment connections are in accordance with the specific manual supplied with the field device and segment coupler / power supply.

The loop is not suffering from interference due to an unstable voltage supply from the segment power supply and / or electrical interference.

- Some bridging devices / LAS implementations provide an optimization whereby some address ranges are not scanned. This may result in individual device not being found.
- After setting address, it may take some time for the device and the Link Active Scheduler (LAS) to synchronise information including address, identity and protocol timing information.

8.5 Device Focus View

In this view the specific information of the device is shown.

- PD tag
- Device Id
- Block List with Target / Actual Mode

On entering 'Device Focus view' the software will load the Blocks of the target field device and make them available for parameterization.

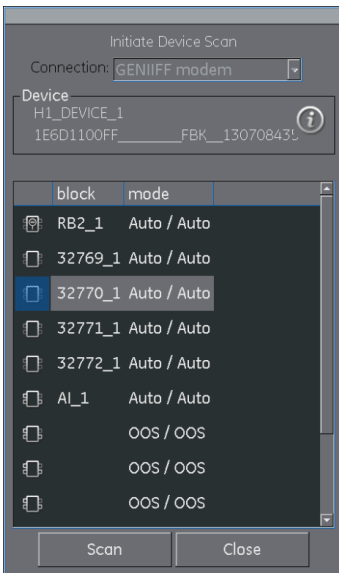

Figure 8-8 Device Focus View

 gives access to the device profile

Figure 8-9 Device Profile

Attribute:	Value:
Manufacturer	GE Sensing
Manufacturer ID	0x004745
Device Name	XMT868
Device Type	0x0001
Serial-No	GE-FLOW- 000004124
PD Tag	000004055 GE Flow Liquid &
Device ID	0047450001-GE-FLOW- 0
H1 Address	33 (0x21)
Device Revision	1
DD Revision	4
Device Class	Basic (no LM)

Selecting the **Scan** button returns device scan view (reference Figure 8-5).

Selecting the desired block with a single key press will open the Navigation Tree for the block (Refer to section 8.6).

8.6 The Navigation Menu Tree

This is the overview of the entire loaded block of the device (this is not the entire field device only one aspect of it) showing all the menus available according to the configured access level. Many field devices have additional menus that become visible when certain access rights are enabled or other parameters set. The navigation tree shows nested menus with a '+' to the left of the description. A momentary touch of this symbol opens up the view to the lower level. This view can be closed by touch on the view '-' setting. In this way even complex devices menu structures can be navigated quickly and clearly.

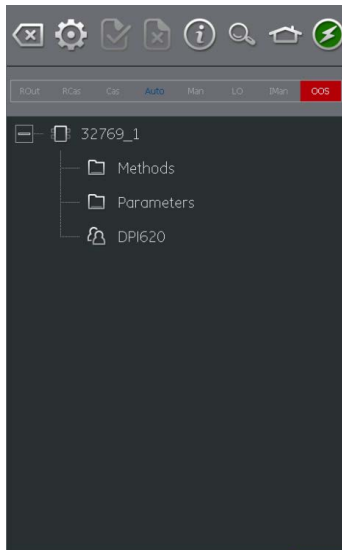

Figure 8-10 Navigation Tree

8.6.1 7.6.1 Block Header bar

The block header bar indicates the target and actual mode of the block.



Figure 8-11 Block Header Bar

The Highlighted text indicates the actual mode of the device block. The highlight is shown in green if the target mode is equal to the actual mode of the device block. If the target mode does not equal the actual mode of the device block, the highlight is in red.

The target mode of the device block is indicated by blue text.

Available options are indicated by black text, unavailable options are shown in grey.

The target mode can be changed with a momentary touch on the block header.

Figure 8-11 shows example where target mode is Auto but actual mode is Out of Service (OOS).

8.7 Functional Group View

The functional groups show all the variables or settings in that menu group along with the current value.

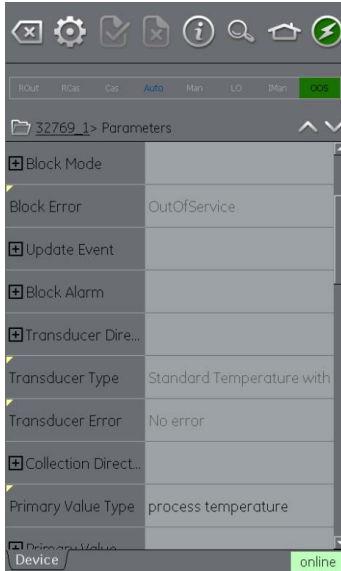

Figure 8-12 Function Group View

The left side hosts the 'Variable Description Area' and access to the context based adjustment functions.

The right side with light background hosts the 'Variable Editing Area' and access to value adjustment.

A grey value is associated with a read only value such as a variable that the device produces.



Black variables are open for editing under the appropriate access conditions, such as access code or PIN that may be required in a different Functional Group.

The Navigation Tree bar shows the hierarchy of menus and groups above the current Function Group View.



Figure 8-13 Navigation Tree Bar

Navigation back out of the function group is possible by the linked references in the tree bar itself (eg 32769_1 in Figure 8-13).

The up and down   navigation arrows move the selected function group to that of the one above or below the current selection in the menu tree.

Communication activity is signified by the communication progress bar in the bottom right of the screen.

8.7.1 Displaying Parameter Help

- The yellow triangle in the corner of the Variable Description area indicates that help is available for that parameter.
- Context menu opened up with touch and hold action.
- Selecting Display Help will show the help attributes.

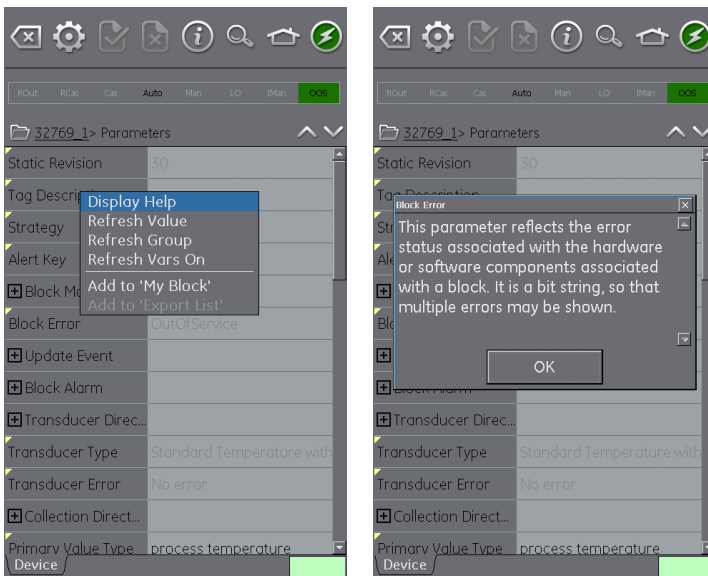

Figure 8-14 Parameter Help

8.7.2 Refreshing Data

When a refresh is in progress the variable description goes grey and in the right area of the Variable Editing area the pending icon appears.



When the read request is fulfilled the variable description goes from grey to black again and the pending icon disappears.



Refreshing Data can be selected from the context menu.



- Refresh Value Updates selected value only
- Refresh Group Updates all values in the function group
- Refresh Vars On Automatically Refreshes Values
- Refresh Vars Off Manual Refresh required to Update Values

8.7.3 Editing Values

Values which may be editable are shown in black in the “variable editing area” of the function group view (Refer to Figure 8-12). Select the parameter to open for editing.

Once Edit is complete, the variable description is highlighted in bold and the commit and cancel icons in the toolbar become active.



-  Commits all Update
-  Aborts all Updates

Individual updates can be reverted by selecting **Revert Value** from the context menu. (Accessed by a touch and hold action on the variable description). Note: This can only occur if the update has not yet been committed.

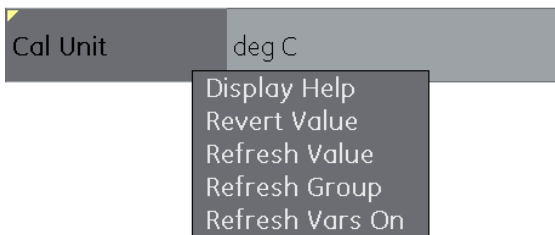

Figure 8-15 Revert Value

If an invalid value is entered the variable will be shown in red and the error icon appears.



8.7.4 Methods

These are viewed as a button or selection menu. In the case of a button, a momentary touch activates the execution of the associated functionality. The user then follows any defined prompts to walk through the method.

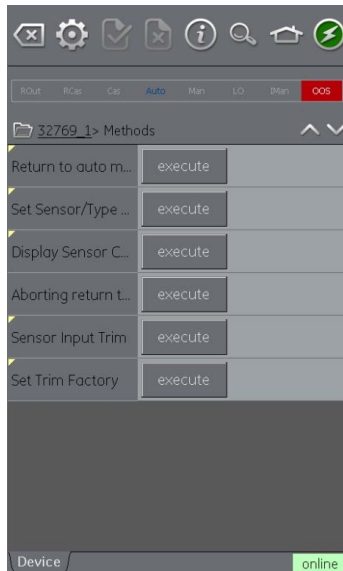



Figure 8-16 Methods

8.8 Function Finder

Function Finder is a way of searching for FF variables and device functions in the on-line device. In complex devices with multiple menus this allows the user to navigate a device without a manual, greatly simplifying the on-line experience, even with an unfamiliar device.

The system requires the input of the name of the variable concerned (or part thereof) and the results show all variables that match the search. Navigation to the variable is just a single click in the search results. To start a search proceed as follows in the on line or off-line device view.

Select the search icon from  the FOUNDATION™ Fieldbus Toolbar.

1. In Name field enter the text you wish to search for in the on- line device.
2. Select return in the keyboard view followed by the Search button to initiate the search.
3. From the list of results select the parameter that you require. Note that the variable name and the function group it relates to is displayed.
4. Function Finder will then display the Function Group concerned in the device view with all searched variables highlighted in yellow (refer to Figure 8-17).

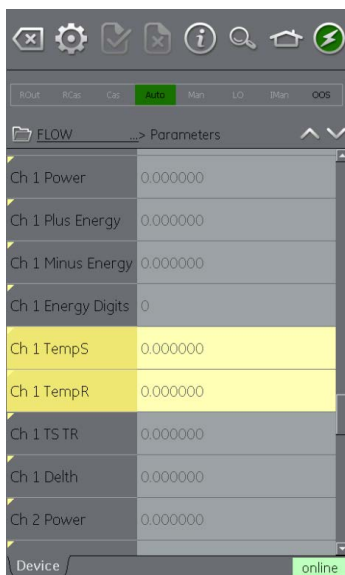

Figure 8-17 Function Finder

8.9 Exporting Data to Main Genii Application

The FOUNDATION™ Fieldbus application allows selected parameters to be displayed in the Communications channel windows for the Calibrator screen.

The selected parameters are defined by the Export List Menu.

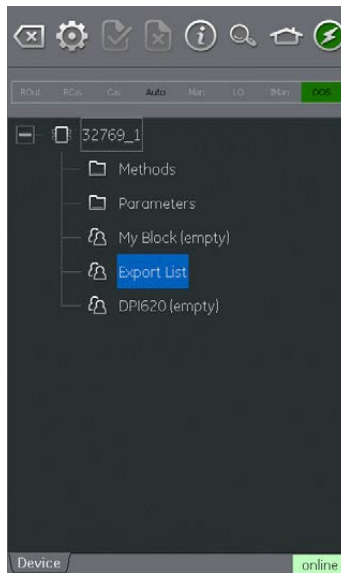

Figure 8-18 Export List

Parameters are added to the Export List using the context menu in the Variable Description area (refer to Section 8.7) and selecting 'Add to 'Export List'.

Note: Only Parameters that return a value can be added to the Export List.

A Maximum of 6 parameters can be added to the Export List.

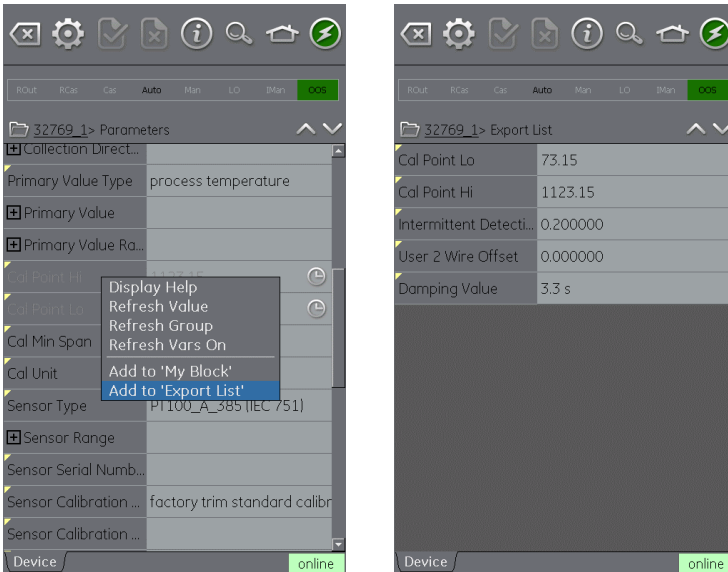



Figure 8-19 Adding Items to Export List

Items on List can be viewed by selecting the Export List menu.

8.9.1 Viewing Exported Variables in Channel Window

Return to Main Application by Minimizing the FOUNDATION™ Fieldbus application.

 HOME >> Minimize

Expand the FOUNDATION™ Fieldbus window and select:

 Settings >> PRIMARY VALUE

The Export List of selected parameters will be displayed. The selected parameter will be displayed in the FOUNDATION™ Fieldbus channel window.

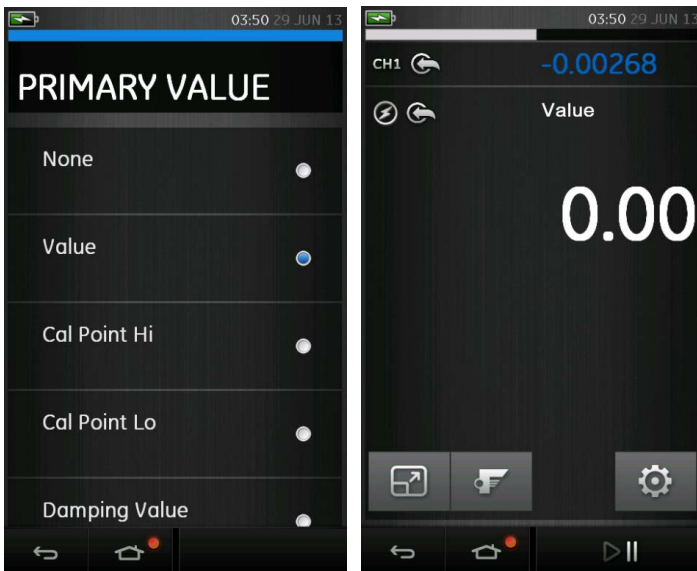

Figure 8-20 Displaying Primary Value

8.10 My Block

My Block allows the user to create Menus of commonly used parameters for easy recall.

Additional Menus can be created under 'My Block' using the context menu accessed with touch and hold gesture.

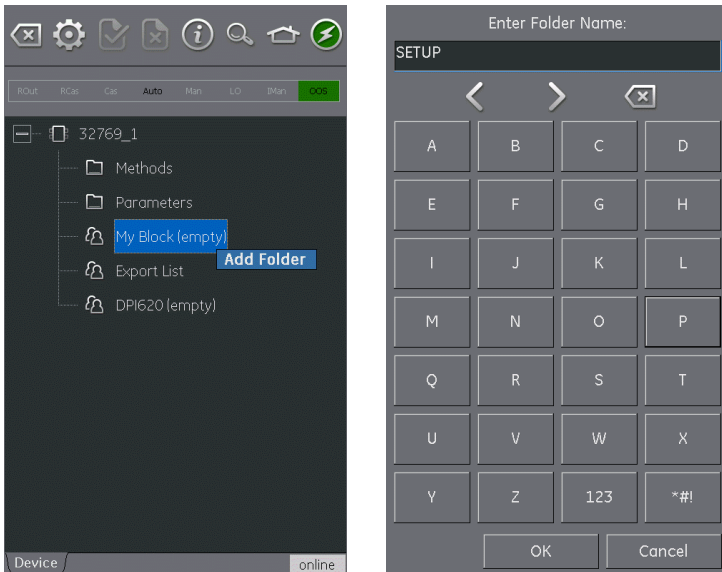

Figure 8-21 Add 'My Block' Menu

Parameters are added to 'My Block' (or the created Menu) using the context menu in the Variable Description area (refer to Section 8.7).

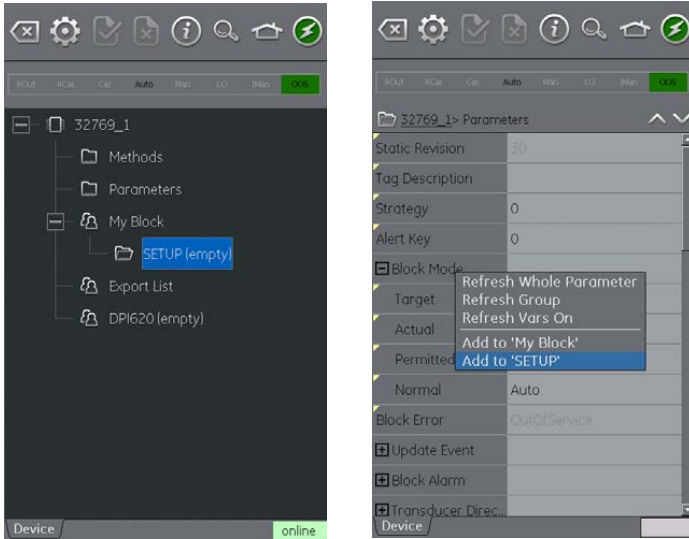

Figure 8-22 Adding Parameters to 'My Block'

8.11 Application Settings

Application settings are access from the FOUNDATION™ Fieldbus toolbar by selecting:



8.11.1 Device Library

The library tab shows the Device Descriptions (DDs) that are currently on the DPI620 Genii. Allows the user to browse for a specific device to determine that there is support for it.

To request support for a non-registered DD please contact your local GE Service centre (refer to Section 1.15).

8.11.2 Options

- **Poll header every** - Sets the refresh rate for the device parameters displayed in the header.
- **Poll all dynamic every** - Sets the refresh rate for FF dynamic variables in the function group view (note this setting only becomes valid if the function group option **Refresh Vars On** is active) (refer to Section 8.7.2).
- **Enable Device Library Monitor** - If checked enables the automatic check of the Open Field Communications DD library on application start up for new Device Descriptions. Note this configuration option requires a network path to the Internet. After installation the default setting is 'checked'.
- **Confirm Device Commits** - If checked brings up a confirmation dialog before every write is committed to the field device. After installation the default setting is 'checked'.
- **Enable My Device Functions** - Enables the My Device and Export to DPI620 Genii functions. After installation the default setting is 'checked'.
- **Enable Value Range Checking** - If checked ensures that all variable edits are within the limits specified by the device. After installation the default setting is 'checked'.
- **Enable Function Blocks** - If checked function blocks are enabled. After installation the default setting is 'unchecked'.
- **Enable Transducer Blocks** - If checked transducer blocks are enabled. After installation the default setting is 'checked'.

8.11.3 Advanced

These settings are for advanced users only and it is recommended to retain Default Values.

9 Calibration Procedures

Note: GE Measurement and Control can provide a calibration service that is traceable to international standards.

Note: GE Measurement and Control recommend returning the instrument to the manufacturer or an approved service agent for calibration. If using an alternative calibration facility, check that it uses the standards that follow.

9.1 Before Starting

Use only original parts supplied by the manufacturer. To do an accurate calibration, use the following:

- Calibration equipment specified in Table 9-1.
- Stable temperature environment: $21 \pm 1^{\circ}\text{C}$ ($70 \pm 2^{\circ}\text{F}$).

Before starting a calibration procedure, it is recommended leaving the equipment in the calibration environment for a minimum of two hours.

Table 9-1

Function	Calibration equipment (ppm = parts per million)	
Current (CH1 or CH2)	Current (mA) calibrator. Accuracy - Current measure/source, refer to Table 9-2 or Table 9-3	
Voltage (CH1 or CH2)	Volts calibrator. Accuracy - Voltage measure/source, Refer to Table 9-5 or Table 9-7	
Millivolts (CH1 or CH2) OR TC mV (CH1)	mV calibrator. Accuracy - Millivolts measure/source, refer to Table 9-4 or Table 9-6 1. Accuracy - TC mV refer to	
Frequency (CH1)	measure	source
	Signal generator Total error: 0.3 ppm or better	Frequency meter Total error: 0.3 ppm or better Resolution: 8 digits (minimum)
Resistance (CH1)	measure	source
	Standard resistor 100R, 200R, 300R, 400R, 1k, 2k, 4k Total uncertainty: 20 ppm	An ohmmeter or an RTD measurement system with the specified excitation currents, refer to Table 9-13
Cold Junction (CH1)	Calibrated K type thermocouple Accuracy: 50 mK for -5 to 28°C (23 to 82.4°F)	

Function	Calibration equipment (ppm = parts per million)
	Thermocouple temperature reference unit (0°C) Accuracy: 30 mK
AC mV (CH1)	AC mV calibrator. Accuracy - AC mV measure, Refer to Table 9-15
AC Volts (CH1)	AC Volts calibrator. Accuracy - AC Volts measure, Refer to Table 9-16
Pressure (P1 or P2)	Genii Module Carrier MC620G or Genii Pressure Base PV62XG: Range 25 mbar/0.36 psi: total uncertainty of 0.015% reading or better Ranges > 25 mbar/0.36 psi: total uncertainty of 0.01% reading or better
IDOS	UPM only. Refer to the user manual for the IDOS UPM.

Before starting the calibration, check the time and date on the instrument are correct.

To do a calibration on a measure or source function, use the advanced menu option.

1. Select:

DASHBOARD >>  ADVANCED

2. Enter the calibration PIN: 4321
3. Select the  button.
4. Select:

PERFORM CALIBRATION

Then select a function and start the calibration:

1. Select channel
2. Select function
3. Select range (if applicable)
4. Follow on-screen instructions

When the calibration is complete, set the next calibration date.

9.2 Procedures (CH1/CH2): Current (measure)

When recalibrating measure functions for this range, any adjustment will affect the corresponding source function calibration. The source function must, therefore be recalibrated after adjusting the measure function.

Do the procedure as follows:

1. Connect the applicable calibration equipment (Ref: Table 9-1).
2. Let the equipment get to a stable temperature (minimum: 5 minutes since the last power on).

3. Use the calibration menu (Ref: Section 9.1) to do a three-point calibration (-FS, Zero and +FS) for each range: 20 mA and 55 mA.
4. Check the calibration is correct.
 - Select the applicable Current (measure) function, (Ref: Section 2).
 - Apply the values that follow:
 - mA: -55, -25, -20, -10, -5, 0 (open circuit)
 - mA: 0, 5, 10, 20, 25, 55.
 - Check the error is in the specified limits (Ref: Table 9-2).

Table 9-2 Current (measure) error limits

Applied mA	Calibrator uncertainty (mA)	Permitted DPI 620 error (mA)
±55	0.003	0.0055
±25	0.0025	0.0040
±20	0.00063	0.0022
±10	0.00036	0.0016
±5	0.00025	0.0013
0 (open circuit)	0.0002	0.0010

9.3 Procedures (CH1/CH2): Current (source)

Do the procedure as follows:

1. Connect the applicable calibration equipment (Ref: Table 9-1):
 - CH1/CH2 (24 mA range): (Ref: Section 2 and Section 2.9).
 - CH2 (-24 mA range only): (Ref: Section 2 and Section 2.9).
2. Let the equipment get to a stable temperature (minimum: 5 minutes since the last power on).
3. Use the calibration menu (Ref: Section 9.1) to do a two-point calibration (0.2 mA and FS):
 - CH1 (one range): 24 mA.
 - CH2 (two ranges): 24 mA (reverse) and 24 mA (forward).

Note: Input positive values for the forward and reverse calibration.

- 4. Check the calibration is correct:
 - Select the applicable Current (source) function(Ref: Section 2 and Section 2.9).
 - Apply the values that follow:
CH1/CH2: 0.2, 6, 12, 18, 24
 - Check the error is within limits (Ref: Table 9-3)

Table 9-3 Current (source) error limits

Source mA	Calibrator uncertainty (mA)	Permitted DPI 620 error (mA)
±0.2	0.00008	0.0010
±6	0.00023	0.0016
±12	0.00044	0.0022
±18	0.0065	0.0028
±24	0.0012	0.0034

9.4 Procedures (CH1/CH2): DC mV/Volts (measure)

When recalibrating measure functions for this range, any adjustment will affect the corresponding source function calibration. The source function must, therefore be re-calibrated after adjusting the measure function.

Do the procedure as follows:

1. Connect the applicable calibration equipment (Ref: Table 9-1).
2. Let the equipment get to a stable temperature (minimum: 5 minutes since the last power on).
3. Use the calibration menu (Ref: Section 9.1) to do a three-point calibration.

(-FS, Zero and +FS) for the applicable set of ranges:

mV (measure) ranges	Volts (measure) ranges
200 mV	20 V
2000 mV	30 V

4. Check the calibration is correct:
 - Select the applicable Millivolts or Voltage (measure) function. (Ref: Section 2.5)
 - Apply the input values that are applicable to the calibration:

mV: -2000, -1000, -200, -100, 0 (short circuit)

mV: 0, 100, 200, 1000, 2000

Volts (V): -30, -21, -20, -10, -5, 0 (short circuit)
 Volts (V): 0, 5, 10, 20, 21, 30.

- Check that the error is within limits (Ref: Table 9-4 or Table 9-5).

Table 9-4 Millivolts (measure) error limits

Applied mV	Calibrator uncertainty (mV)	Permitted DPI 620 error (mV)
±2000	0.051	0.14
±1000	0.040	0.1
±200	0.0051	0.017
±100	0.0040	0.0125
0 (short circuit)	0.0036	0.008

Table 9-5 Voltage (measure) error limits

Applied V	Calibrator uncertainty (V)	Permitted DPI 620 error (V)
±30	0.00052	0.0021
±21	0.0004	0.0018
±20	0.00031	0.0009
±10	0.00016	0.00065
±5	0.00008	0.00053
0	0.000024	0.0004

9.5 Procedures (CH1): DC mV/Volts (source)

Do the procedure as follows:

1. Connect the applicable calibration equipment (Ref: Table 9-1).
2. Let the equipment get to a stable temperature (minimum: 5 minutes since the last power on).
3. Use the calibration menu (Ref: Section 9.1) to do a two-point calibration (Zero and +FS) for the applicable range:

mV (source) ranges	Volts (source) ranges
2000 mV	20 V

4. Check the calibration is correct:
 - Select the applicable Millivolts or Voltage (measure) function (ref Section 2.5). Apply the input values that are applicable to the calibration:
mV: 0, 100, 200, 1000, 2000
Volts (V): 0, 5, 10, 15, 20.
 - Check the error is within limits (Ref: Table 9-6 or Table 9-7)

Table 9-6 millivolts (source) error limits

Source mV	Calibrator uncertainty (mV)	Permitted DPI 620 error (mV)
0	0.0001	0.008
100	0.00046	0.0125
200	0.0009	0.017
1000	0.003	0.1
2000	0.006	0.14

Table 9-7 Voltage (source) error limits

Source V	Calibrator uncertainty (V)	Permitted DPI 620 error (V)
0	0.000004	0.00042
5	0.000019	0.0007
10	0.000034	0.00010
15	0.000049	0.00013
20	0.000064	0.0016

9.6 Procedures (CH1): Frequency (measure/source)

Only do one frequency calibration, use either the measure function or the source function.

Frequency calibration (measure function)

Do the procedure as follows:

1. Connect the applicable calibration equipment
(Ref: Table 9-1)
2. Let the equipment get to a stable temperature
(minimum: 5 minutes since the last power on)
3. Set-up the equipment as follows:

Signal generator: Output = 10V
 Unipolar
 Square wave
 Frequency = 990 Hz

Druck DPI 620 Genii: Input units = Hz
 Input trigger level = 5 V

4. Use the calibration menu (Ref: Section 9.1) to do a one-point calibration.
5. Check the calibration is correct.

Frequency calibration (source function)

Do the procedure as follows:

1. Connect the applicable calibration equipment (Ref: Table 9-1).
2. Let the equipment get to a stable temperature (minimum: 5 minutes since the last power on).
3. Set-up the equipment as follows:

Frequency meter: Gate time = one second

Druck DPI 620 Genii: Waveform = Square;
 Amplitude = 10 V
 Frequency = 990 Hz

4. Use the calibration menu (Ref: Section 9.1) to do a one-point calibration.
5. Check the calibration is correct.

Frequency calibration check

- Frequency (measure) calibration check.

Signal generator: Output = 10 V
 Unipolar
 Square wave

Druck DPI 620 Genii: Input trigger level = 5 V
 Units: Hz or kHz as specified in

.

Table 9-8 or Table 9-9

- Frequency (source) calibration check.

Frequency meter:

Gate time = one second

- **Druck DPI 620 Genii:**
in Table 9-8.

Units: Hz or kHz as specified

Table 9-8 or Table 9-9

- Select the applicable Millivolts or Voltage (measure) function (ref Section 2.10). Apply the input values:

Hz: 0, 990

kHz: 10, 50

- Check the error is within limits (Ref: Table 9-8 or Table 9-9).

Table 9-8 Hz error limits (measure/source)

Measure/ source Hz	Calibrator uncertainty (Hz)	Permitted DPI 620 error (Hz)	
		(measure)	(source)
100	0.0002	0.0023	0.0026
990	0.0005	0.0050	0.0053

Table 9-9 kHz error limits (measure/source)

Measure/ source kHz	Calibrator uncertainty (kHz)	Permitted DPI 620 error (kHz)	
		(measure)	(source)
10.0000	0.00002	0.00023	0.000067
50.0000	0.00002	0.00035	0.000185

9.7 Procedures (CH1): Frequency Amplitude (source)

Do the procedure as follows:

Note: The procedure that follows calibrates the “mark” value of the square wave frequency output. The “space” value is fixed and is approximately -120 mV.

1. Connect the applicable calibration equipment (Ref: Table 9-1).
2. Let the equipment get to a stable temperature (minimum: 5 minutes since the last power on).
3. Set-up the equipment as follows:

Source frequency = 0 (For DC output);

Waveform = Square

4. Use the calibration menu (Ref: Section 9.1) to do a two-point calibration.

Point 1 = 0.2 V, point 2 = 20 V

5. Check the calibration is correct.
 - Set-up the equipment as follows:
 - Source frequency = 0 (For DC output);
 - Waveform = Square
 - Apply the amplitude values that are applicable to the calibration (Ref: Table 9-10).
 - Check the error is within limits (Ref: Table 9-10).

Table 9-10 Amplitude (source) error limits

Amplitude Volts (V)	Calibrator uncertainty (V)	Permitted DPI 620 error (V)
0.2	0.01	0.1
5.0	0.01	0.1
10.0	0.01	0.1
20.0	0.01	0.1

9.8 Procedures (CH1): Resistance measure)

Do the procedure as follows:

1. Connect the applicable calibration equipment (Ref: Table 9-1).
2. Let the equipment get to a stable temperature (minimum: 5 minutes since the last power on).
3. Use the calibration menu (Ref: Section 9.1) to do a two-point calibration .

Range: 0-400 Ω

- Nominal zero ohms:

Make a 4-wire connection to the 0 Ω

- Nominal positive full-scale ohms

Make a 4-wire connection to the 400 Ω resistor

Range: 400 Ω -4k Ω

- Nominal 400 Ω

Make a 4-wire connection to the 400 Ω resistor

- Nominal positive full-scale ohms

Make a 4-wire connection to the 4k resistor

4. Check the calibration is correct
 - Select the applicable Resistance (measure) function (Ref Section 2.1159).
 - Make a 4-wire connection to the applicable standard resistor (Ref: Table 9-11) and measure the value.
 - Check the error is within limits (Ref: Table 9-11)

Table 9-11 Resistance (measure) error limits

Standard Resistor (Ω)	Resistor uncertainty (Ω)	Permitted DPI 620 error (Ω)
0 (short)	-	0.02
100	0.002	0.032
200	0.004	0.044
300	0.006	0.056
400	0.008	0.068
1000	0.02	0.30
2000	0.04	0.41
4000	0.08	0.64

9.9 Procedures (CH1): True Ohms (measure)

Do the procedure as follows:

1. Repeat procedure 9.8; in step 3 and 4 select True Ohms.
2. Check the error is within limits (Ref: Table 9-1).

Table 9-12 True Ohms (measure) error limits

Standard Resistor (Ω)	Resistor uncertainty (Ω)	Permitted DPI 620 error (Ω)
0 (short circuit)	-	0.004
100	0.002	0.0095
200	0.004	0.015
300	0.006	0.0205
400	0.008	0.026
1000	0.02	0.059
2000	0.04	0.114
4000	0.08	0.224

9.10 Procedures (CH1): Resistance (source)

Do the procedure as follows:

1. Connect the applicable calibration equipment (Ref: Table 9-1).
2. Let the equipment get to a stable temperature (minimum: 5 minutes since the last power on).
3. Use the calibration menu (Ref: Section 9.1) to do a two-point calibration, for each range.
 - Range: 0-400 Ω
 - Range: 400 Ω -2000 Ω
 - Range: 2k Ω -4k Ω

4. Check the calibration is correct:
 - Select the Resistance (source) function (Ref: Section 2.11).
 - Apply the resistance values that are applicable to the calibration (Ref: Table 8-13).
 - Check the error is within limits (Ref: Table 8-13).

Table 9-13 Resistance (source) error limits

Ohms (Ω)	Excitation (mA)	Calibrator uncertainty (Ω)	Permitted DPI 620 error (Ω)
0	0.1	0.0014	0.014
100	0.1	0.0016	0.038
200	0.1	0.0021	0.062
300	0.1	0.0028	0.086
400	0.1	0.0035	0.11
1000	0.1	0.008	0.31
2000	0.1	0.016	0.55
3000	0.1	0.024	0.86
4000	0.1	0.032	1.1

9.11 Procedures (CH1): TC mV (measure or source)

When recalibrating measure functions for this range, any adjustment will affect the corresponding source function calibration. The source function must, therefore be re-calibrated after adjusting the measure function.

Note: To ensure correct calibration when calibrating TC mV measure, the applied voltage values should be measured at the TC terminals by applicable calibration equipment (Ref: Table 9-1).

Do the procedure as follows:

2. Connect the applicable calibration equipment (Ref: Table 9-1).
3. Let the equipment get to a stable temperature (minimum: 5 minutes `since the last power on).
4. Use the calibration menu (Ref: Section 9.1) to do a three-point calibration.

(-10 mV, Zero and 100 mV) for the measure or source function

5. Check the calibration is correct:
 - Select the applicable TC mV (measure) or (source) function (ref Section 2.12).
 - Apply the necessary values:

TC mV (measure): -10, 0 (short circuit)

TC (mV): 10, 25, 50, 100

TC mV (source): -10, 0, 10, 25, 50, 100

6. Check the error is within limits (Ref:
7. Table 9-14).

Table 9-14 TC mV (measure or source) error limits

Input or output	Calibrator uncertainty TC (mV)		Permitted DPI 620 error (mV)	
	TC (mV)	(measure)	(source)	(measure)
-10	0.0036	0.00011	0.0085	0.0090
0	0.0036	0.0001	0.008	0.008
10	0.0036	0.00011	0.0085	0.0090
25	0.0036	0.00015	0.0091	0.0100
50	0.0037	0.00025	0.010	0.0125
100	0.004	0.00046	0.0125	0.0170

9.12 Procedures (CH1): Cold Junction (TC method) and CJ (measure)

Note: Do the TC mV (measure) calibration before the cold junction calibration. The conditions for CJ calibration are as follows:

- Battery mode (with DC charger disconnected)
- CH1 active
- CH2 set to “None”
- Burnout Detection off
- Use miniature TC connectors

There are two methods of doing a cold junction test; the CJ (TC Method) is the preferred method. Both procedures are described as follows:

CJ (TC Method)

Do the procedure as follows:

1. Connect the applicable calibration equipment (Ref: Table 9-1).
2. Set the reference unit temperature: 0°C.
3. Let the equipment get to a stable temperature (minimum: 1 hour since the last power on).
4. Use the calibration menu (Ref: Section 9.1) to do a one-point calibration for the CJ (TC method) function.
5. Calculate the expected reading, using the known error in the thermocouple and reference unit.
6. Check the calibration is correct.
 - Select the TC measure function (Ref: Section 2.12).
 - Check the equipment gives a TC temperature that is the same as the temperature on the reference unit $\pm 0.1^{\circ}\text{C}$ (0.2°F), after correction for the known thermocouple and reference unit error.

CJ

Do the procedure as follows:

1. Connect the applicable calibration equipment (Ref: Table 9-1).
2. Set-up the equipment:
 - Function = TC (measure)
 - TC Type = K Type
 - CJ Compensation, Mode = Automatic
3. Set the reference unit temperature: 0°C
4. Let the equipment get to a stable temperature (minimum: 1 hour since the last power on).
5. Record the values that follow:
 - TC temperature given on the reference unit T (actual)
 - TC temperature given on the calibrator, T (measured)
 - CJ temperature given on the calibrator, CJ (measured)
6. Calculate the CJ (Cal Value) as follows:
 - $CJ \text{ (Cal Value)} = CJ \text{ (measured)} - T \text{ (actual)} + T \text{ (measured)}$.
 - Use the calibration menu to do a one-point calibration for the CJ (measure) function.
 - When the display shows "Sampling complete", set the correct Cal Value = CJ (Cal Value) above.

7. Check the calibration is correct
 - Select the TC (measure) function
8. Check the equipment gives a TC temperature that is the same as the temperature on the reference unit $\pm 0.1^{\circ}\text{C}$ (0.2°F)

9.13 Procedures (CH1): AC mV/Volts (measure)

Do the procedure as follows:

1. Connect the applicable calibration equipment (Ref: Table 9-1).
2. Let the equipment get to a stable temperature (minimum: 5 minutes since the last power on).
3. Use the calibration menu (Ref: Section 9.1) to do a two-point calibration for the applicable AC function.
 - Use the local power supply frequency.
 - For the AC mV (measure) function:
 - point 1 = 200.0 mVAC,
 - point 2 = 2000.0 mVAC
 - For the AC Volts (measure) function:
 - point 1 = 2.000 AC,
 - point 2 = 20.000 VAC

4. Check the calibration is correct:
 - Select the applicable AC mV or AC Volts (measure) function (ref Section 2.6).
5. Apply the input values that are applicable to the Calibration.
 - AC mV: 10, 500, 1000, 2000
 - AC Volts: 5, 10, 20
6. Check the error is within limits (Ref: Table 9-15 or Table 9-16)

Table 9-15 AC mV (measure) error limits

Applied AC mV	Calibrator uncertainty (mV)	Permitted DPI 620 error (mV)
10	0.12	2.5
500	0.2	3.1
1000	0.28	3.75
2000	0.44	5.0

Table 9-16 AC Volts (measure) error limits

Applied AC Volts	Calibrator uncertainty	Permitted DPI 620 error
5	0.0018	0.03
10	0.0026	0.037
20	0.0042	0.050

9.14 Procedures: Pressure Indicator Modules (PM 620)

Do the procedure as follows:

1. Assemble the pressure indicator with the necessary PM620 modules.
2. Connect the instrument to the pressure standard.
3. Let the equipment get to a stable temperature (minimum: 60 minutes since the last power on).
4. Use the calibration menu (Ref: Section 9.1) to do a two-point calibration.
 - Zero and +FS for absolute sensors.

Note: If software version requires a three-point calibration for an absolute sensor, use points at 0, 50% and +FS or three-point calibration:

- -FS, Zero and +FS for gauge sensors.
- (Ref: Table 9-17).

Table 9-17 Calibration pressures

Ranges: gage	Nominal applied pressure mbar (psi)		
	-FS †	Zero	+FS
< 700 mbar (10.0 psi)	-FS	0	+FS
> 700 mbar (10.0 psi)	-900 (-13.1)	0	+FS
†For a three-point calibration, do not apply more than -90% of the specified FS for the unit.			
Ranges: absolute	Nominal applied pressure mbar (psi)		
	Zero		+FS
350 mbar (5.00 psi)	< 1.0 (0.02)		+FS
2 bar (30.0 psi)	< 5.0 (0.07)		+FS
7 bar (100.0 psi)	< 20.0 (0.29)		+FS
20 bar (300.0 psi)	< 50.0 (0.73)		+FS
350 bar (5000 psi)	Use atmospheric pressure as zero.		+FS

5. Check the calibration is correct:
 - Select the applicable pressure function.
 - Apply the following pressure values (absolute sensors).
 - 0, 20, 40, 60, 80, 100 (%FS).
 - Go back to 0 in the same steps.
 - Apply the following pressure values (gauge sensors).
 - 0, 20, 40, 60, 80, 100 (%FS).
 - Go back to 0 in the same steps.
 - Check the error is within limits (Ref: Table Gauge Ranges and Absolute Ranges).
 - Gauge ranges or absolute ranges tables (Ref: datasheet).
 - Use the values in the total uncertainty column.
 - The specified values include an allowance for temperature changes, reading stability for one year, and the uncertainty of the standard used for calibration.

9.15 Procedures: IDOS UPM

(Ref: User manual IDOS UPM).

When the calibration is complete, the instrument automatically sets a new calibration date in the UPM.

10 General Specification

10.1 Introduction

For a full specification of the Druck DPI 620 Genii calibrator and its related accessories (MC 620 carrier, PM 620 module and PV 62x pressure stations) refer to the relevant product datasheet.

The DPI 620 is suitable for indoor use with the following environmental requirements. It is permitted to use the DPI 620 outdoors as a portable instrument if the environmental requirements are met.

Display	LCD: Colour display with touch-screen
Operating temperature	-10 to 50°C (14 to 122°F)
Storage temperature	-20 to 70°C (-4 to 158°F)
Ingress Protection	IP55 (Druck DPI 620 Genii calibrator only)
Humidity	0 to 90% relative humidity (RH) non-condensing
Shock/Vibration	MIL-PRF-28800F for class 2 equipment
Pollution Degree	2
EMC	Electromagnetic compatibility: BS EN 61326-1:2006
Electrical safety	Electrical - BS EN 61010:2010
Pressure safety	Pressure Equipment Directive - Class: Sound Engineering Practice (SEP)
Approved	CE Marked
Battery power	<p>Lithium-Polymer battery (GE Part number: 191-356)</p> <p>Capacity: 5040 mAh (minimum), 5280 mAh (typical), Nominal voltage: 3.7 V.</p> <p>Charge temperature: 0 to 40°C (32 to 104°F) outside this range, charging stops.</p>

- Note 1: The DPI 620 has been assessed to the European IEC60529 standard as having an ingress protection rating of IP55, but this is for reliability purposes and not for safety reasons.
- Note 2: To meet the immunity requirements of annex A of EN61326-1:2006, when used in an industrial environment, the unit must be battery powered to guarantee measurement specification.
- Note 3: The case of the DPI620 is not suitable for prolonged exposure to UV.
- Note 4: The DPI620 is not suitable for permanent installation in an outdoor environment.

















11 Manufacturer

Druck Limited
Fir Tree Lane
Groby
Leicester
LE6 0FH
United Kingdom

Tel: +44 (0)116 231 7100

12 Display Icons

Table 12-1 Dashboard Icons

	Advanced		Hart®
	Calibrator		Help
	Data Logging		LED (shows status) Blue – Active Red – Alarm Green - Connected
	Touchscreen		Multimeter
	Documenting		Scope
	Foundation Fieldbus		Settings
	Files		Status
	Applications		Devices