

1811D (SERIES)

PITOT-STATIC TEST SET

USER INSTRUCTION MANUAL
M/N: 1811D, P/N: 101-00164-SERIES

*Doc. P/N: 56-101-00164
Revision F
April 19, 2013*

BARFIELD, INC.



T A T G R O U P

Corporate Headquarters

4101 Northwest 29th Street

Miami, Florida 33142

www.barfieldinc.com

Email: gsesales@barfieldinc.com

Barfield Inc. Confidential and Proprietary Information.

This document and all the information contained herein is the sole property of Barfield Inc.

No intellectual property rights are granted by the delivery of this document or the disclosure of its content.

*This entire document is **proprietary information** and shall **not** be reproduced or disclosed to a third party without the express written consent of Barfield Inc.*

This document and its content shall not be used for any purpose other than that for which it is supplied.



1811D INSTRUCTION MANUAL

CONTACT INFORMATION

Users are requested to notify the manufacturer of any discrepancy, omission, or error found in this manual. Inquiries should include specific questions and reference the publication title, number, chapter, page, figure, paragraph, and effective date.

Please send comments to:

**TECHNICAL CUSTOMER SUPPORT - GSTE
BARFIELD, INC.
P.O. BOX 025367
MIAMI, FL 33102-5367
USA**

Telephone **(305) 894-5400**
 (800) 321-1039

Fax **(305) 894-5401**

Email gsesales@barfieldinc.com



1811D INSTRUCTION MANUAL

ATTENTION

Although every effort has been made to provide the end user of this equipment with the most current and accurate information, it may be necessary to revise this manual in the future. Please be sure to complete and return the enclosed **OWNER WARRANTY REGISTRATION CARD** to Barfield in order to validate the warranty and to ensure that you will receive updated information when published. You **MUST** have your name and address on file at Barfield as a registered user of this equipment, to be able to obtain the service covered by the warranty.

Visit the company website, <http://barfieldinc.com/>, for publication updates.

Please send the Registration Card to:

Barfield, Inc.
P.O. Box 025367
Miami, FL 33102-5367
USA



1811D INSTRUCTION MANUAL

1811 SERIES PITOT-STATIC TEST SET

INFORMATIONAL LETTER

The *Barfield 1811 series Pitot-Static Testers* are not advertised for use to comply with FAR 91.411. The Test Sets do fully meet the requirements of DOT Advisory Circular 43-203B for performing Altimeter and Static System Tests and Inspections. However, the personnel requirements and some of the technical aspects of actual testing put a sizeable burden on the person or persons performing the test.

Barfield advertises its 1811 series Test Sets as general-purpose trouble-shooting testers. With respect to compliance with FAR 91.411, we feel that the customer should first be aware of **all** requirements for performing test tests in the field. With this in mind, Barfield stands ready to offer advice and assistance to its customers for accomplishing the required tests.

In conclusion, the Barfield 1811 Series Pitot-Static Testers meet the requirements for compliance with FAR 91.411, but it is important that the customer be sure that the use of the test set will be in compliance with the regulations.

Please note that a *Barfield Altimeter and Static Test Procedure* (Document number 60-101-00150) is available to use in compliance with FAR 91.411.

1811D INSTRUCTION MANUAL

REVISION RECORD

REV.	ECO #	REV. DATE	DESCRIPTION OF CHANGE
A	N/A	Mar/11/2003	Initial Release. This Instruction Manual replaces TM1811D/E, dated 10/1/82.
B	260-00729	Jul/02/2008	Updated Company logo. Sections and page numbering were reorganized.
C	260-00746	Dec/16/2008	A numeric code was added at the end of the former P/Ns, to identify the instruments configuration supplied with a particular unit.
D	260-00779	Apr/29/2010	Additional information was included in the Certification paragraph (page 3)
E	260-00828	Mar/25/11	Updated warranty; Table 5: Required Inspection updated; shipping and storage information
F	260-00968	Apr / 19 / 13	Amended Static Preset information; updated gauge information regarding inspection



1811D INSTRUCTION MANUAL

MAINTENANCE AND REPAIR INFORMATION

The manufacturer of this equipment does not recommend the user to attempt any maintenance or repair. In case of malfunction, contact the manufacturer, to obtain the list of approved repair facilities worldwide, ensuring that this equipment will be serviced using proper procedures and certified instruments.

BARFIELD PRODUCT SUPPORT DIVISION

Telephone (305) 894-5400
(800) 321-1039

Fax (305) 894-5401

Shipping Address:

Barfield, Inc.
4101 NW 29th Street
Miami, Florida 33142
USA

Mailing Address:

Barfield, Inc.
P.O. Box 025367
Miami, FL 33102-5367
USA



T A T G R O U P

1811D INSTRUCTION MANUAL

THIS PAGE INTENTIONALLY LEFT BLANK



1811D INSTRUCTION MANUAL

TABLE OF CONTENTS

Contact Information
Attention Page
Informational Letter Page
Revision Record Page
Maintenance Information
Table of Contents
List of Figures and Tables

<u>SECTION</u>	<u>PAGE</u>
INTRODUCTION	
1. PUBLICATION BREAKDOWN	1
2. INFORMATION PROVIDED WITH THE UNIT	1
3. RECERTIFICATION	2
1. DESCRIPTION	
1. GENERAL DESCRIPTION	5
2. PHYSICAL DESCRIPTION	6
2. SPECIFICATIONS	
1. PHYSICAL DATA	9
2. INPUT POWER	9
3. OPERATION	
1. THEORY OF OPERATION	11
2. 1811D OPERATIONAL SCHEMATIC DIAGRAM	11
3. 1811D PLUMBING SCHEMATIC DIAGRAM	12
4. PRELIMINARY	12
5. PRETESTS	13
6. PITOT SYSTEM TEST	15



1811D INSTRUCTION MANUAL

TABLE OF CONTENTS (Continued)

<u>SECTION</u>	<u>PAGE</u>
3. OPERATION (continued)	
7. STATIC SYSTEM TEST	16
8. STATIC LEAK TEST	16
9. COMBINED PITOT / STATIC TEST	19
10. MACHMETER TEST	22
11. ENGINE PRESSURE RATIO TEST	23
12. MANIFOLD PRESSURE GAUGE TEST	23
13. LOW PRESSURE TEST	24
14. VACUUM TEST	26
4. VALVE LEAK TEST	
1. METERING VALVE ADJUSTMENT PROCEDURE	27
2. RESETTING NEEDLE VALVE POSITIVE STOP	29
5. INSPECTION RECOMMENDATIONS	31
6. SHIPPING	33
7. STORAGE	34
APPENDIX (ENGINEERING SPECIFICATIONS)	35
1. ALTIMETER	A
2. AIRSPEED INDICATOR	B
3. VERTICAL SPEED INDICATOR	C



1811D INSTRUCTION MANUAL

LIST OF FIGURES AND TABLES

<u>SECTION</u>	<u>FIGURE / TABLE</u>	<u>TITLE</u>	<u>PAGE</u>
INTRO	1	Identification Label	1
INTRO	2	Limited One Year Warranty	3
1	3	1811D Pitot-Static Test Set.....	5
1	4	Leading Particulars	6, 7
3	5	1811D Operational Schematic Diagram.....	11
3	6	1811D Plumbing Schematic Diagram	12
3	7	1811D Panel Mounted Components	13
3	1	Airspeed vs. Mach Number Table.....	22
3	2	EPR Test Table.....	23
3	3	Altitude vs. Manifold Pressure Table.....	24
3	4	Airspeed Equivalent for Differential Pressure Table	25
5	5	Required Periodic Inspections	31



1811D INSTRUCTION MANUAL

THIS PAGE INTENTIONALLY LEFT BLANK

1811D INSTRUCTION MANUAL

INTRODUCTION

1. PUBLICATION BREAKDOWN

This instruction manual establishes the operation standards for the 1811D Pitot-Static Test Set.

2. INFORMATION PROVIDED WITH THE UNIT

Besides this User Instruction Manual, the 1811D Test Set is provided with the items described below.

- A. An identification label similar to Figure 1 and located on the front bulkhead of the Test Set, provides the following information:

Manufacturer Name	
Designation of Equipment	
Equipment Part Number	
Equipment Model Number	Equipment Serial Number
Equipment Modification (if applicable)	Equipment Options (if applicable)

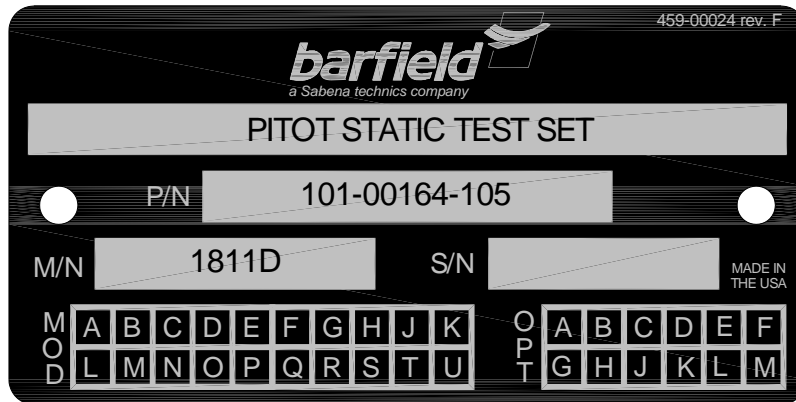

IDENTIFICATION LABEL
Figure 1



1811D INSTRUCTION MANUAL

- B. Each new or re-certified unit is delivered with a Certificate that shows the date when the unit was tested by the manufacturer, its serial number, and when the next certification is due. This certificate confirms that the unit performed according to its design specifications.

3. **RECERTIFICATION**

The Test Sets P/N 101-00184 and P/N 101-00185 have a 6-month recertification period when analog instruments are installed. However, when digital instruments are installed the recertification period is typically one year. For complete specifications on digital instruments, refer to documents 61-101-02184 and 61-101-02194.

It is strongly recommended that the manufacturer, Barfield Inc., service the Test Set. This will ensure that all applicable engineering change orders are incorporated during the required maintenance or recertification processes, which are to be done following Barfield-approved procedures. Additionally, at this time only Barfield technicians are qualified to service the digital instruments.

Note: It is important that the customer ensures the Test Set is in compliance with the Recertification requirement.

Note: If the Test Set is to be used in compliance with F.A.R. 91.170 and Part 43, Appendix E, "Altimeter System Tests and Inspections," refer to FAA Advisory Circular AC43-6B (or subsequent) for approved inspection intervals and procedures.



1811D INSTRUCTION MANUAL



LIMITED ONE YEAR WARRANTY

BARFIELD INC. ("BARFIELD") warrants only to the original Purchaser of this product from BARFIELD or an authorized distributor that this product will be free from defects in material and workmanship under normal use and service for one year after date of purchase. BARFIELD reserves the right, before having any obligation under this limited warranty, to inspect the damaged BARFIELD product, and all costs of shipping the BARFIELD product to BARFIELD for inspection shall be borne solely by the Purchaser. In order to recover under this limited warranty, Purchaser must make claim to BARFIELD within 60 days of occurrence, and must present acceptable proof of original ownership (such as a purchase order, invoice, warranty card registration, or other documentation BARFIELD deems acceptable) for the product. BARFIELD, at its option, shall repair or replace the defective unit covered by this warranty. Please retain the dated sales receipt as evidence of the original purchaser's date of purchase. You will need it for any warranty service. In order to keep this limited warranty in effect, the product must have been handled and used as prescribed in the instructions accompanying this product. This limited warranty does not cover any damage due to accident, misuse, abuse or negligence. This limited warranty is non-transferable and does not apply to any purchaser who bought the product from a reseller or distributor not authorized by BARFIELD, including but not limited to purchases from internet sites. This warranty does not affect any other legal rights you may have by operation of law. Contact BARFIELD at www.Barfieldinc.com or customer service at (305) 894-5506 for warranty service procedures.

DISCLAIMER OF WARRANTY

EXCEPT FOR THE LIMITED WARRANTY PROVIDED HEREIN, TO THE EXTENT PERMITTED BY LAW, BARFIELD DISCLAIMS ALL WARRANTIES, EXPRESS OR IMPLIED, INCLUDING ALL WARRANTIES OF MERCHANTABILITY AND/OR FITNESS FOR A PARTICULAR PURPOSE. TO THE EXTENT THAT ANY IMPLIED WARRANTIES MAY NONETHELESS EXIST BY OPERATION OF LAW, ANY SUCH WARRANTIES ARE LIMITED TO THE DURATION OF THIS WARRANTY. SOME STATES/PROVINCES DO NOT ALLOW LIMITATIONS ON HOW LONG AN IMPLIED WARRANTY LASTS, SO THE ABOVE LIMITATIONS MAY NOT APPLY TO YOU.

LIMITATION OF LIABILITY

REPAIR OR REPLACEMENT OF THIS PRODUCT, AS PROVIDED HEREIN, IS YOUR EXCLUSIVE REMEDY. BARFIELD SHALL NOT BE LIABLE FOR ANY SPECIAL, INCIDENTAL OR CONSEQUENTIAL DAMAGES, INCLUDING, BUT NOT LIMITED TO, LOST REVENUES, LOST PROFITS, LOSS OF USE OF SOFTWARE, LOSS OR RECOVERY OF DATA, RENTAL OF REPLACEMENT EQUIPMENT, DOWNTIME, DAMAGE TO PROPERTY, AND THIRD-PARTY CLAIMS, ARISING OUT OF ANY THEORY OF RECOVERY, INCLUDING WARRANTY, CONTRACT, STATUTORY OR TORT. NOTWITHSTANDING THE TERM OF ANY LIMITED WARRANTY OR ANY WARRANTY IMPLIED BY LAW, OR IN THE EVENT THAT ANY LIMITED WARRANTY FAILS OF ITS ESSENTIAL PURPOSE, IN NO EVENT WILL BARFIELD'S ENTIRE LIABILITY EXCEED THE PURCHASE PRICE OF THIS PRODUCT. SOME STATES/PROVINCES DO NOT ALLOW THE EXCLUSION OR LIMITATION OF INCIDENTAL OR CONSEQUENTIAL DAMAGES, SO THE ABOVE LIMITATION OR EXCLUSION MAYNOT APPLY TO YOU. THIS WARRANTY GIVES YOU SPECIFIC LEGAL RIGHTS AND YOU MAY ALSO HAVE OTHER RIGHTS THAT VARY FROM STATE TO STATE AND PROVINCE TO PROVINCE.

BARFIELD INC.

4101 NW 29th Street
Miami, Florida 33142, USA

Form 7.5.3-13
Dated 02/01/2011, Rev. 0

LIMITED ONE YEAR WARRANTY **Figure 2**



1811D INSTRUCTION MANUAL

THIS PAGE INTENTIONALLY LEFT BLANK

1811D INSTRUCTION MANUAL

SECTION 1: DESCRIPTION

1. GENERAL DESCRIPTION

The Barfield 1811D Pitot Static Test Set (Fig. 3), housed in a plastic carrying case, is a portable, self-contained field tester designed to test aircraft pitot and static systems for leaks as well as the operation and calibration of airspeed, altimeter, engine pressure ratio, manifold pressure indicators, and other vacuum or low pressure units.

Panel mounted hand pumps are equipped with reservoir tanks to supply pressure and vacuum. Metering valves provide control of all pneumatic functions. External pressure ports supply the necessary pressure and vacuum needed for on-board testing. The 1811D has a 50 to 650 knot sensitive airspeed and is available with a 35, 000 or 50,000 ft altimeter.

The tester consists of a hand-operated vacuum pump, a hand-operated pressure pump vacuum and pressure gauges, 5 control valves, an altimeter and an airspeed indicator. The package accessories include two 25-foot hoses, a pitot mast adapter, and a static port adapter kit which enable the user to connect the aircraft pitot and static lines.



1811D PITOT-STATIC TEST SET

Figure 3

Different alternatives are available for the altimeter and airspeed indicators that are installed in the tester, so the three-digit code that follows the basic part number of the 101-00164, identifies which combination of them is provided with a particular tester. The first digit indicates the airspeed range; the last digit in the code identifies the altimeter range (the middle digit is always zero). Possible alternatives for both indicators are shown in the

1811D INSTRUCTION MANUAL

following table. For example, P/N 101-00164-**105** is identified as an 1811D tester with a 650 knot airspeed indicator and a 35,000 feet altimeter. (The 1811D is also available with the Barfield DAS650 digital airspeed and DALT55 digital altimeter.)

Airspeed Code	Airspeed Range
1	650 knots (50-650 kts)
4	420 knot (60-420 kts)
6	250 knot (20-250 kts)
9	SPECIAL
A	DALT650, 650 kt range

Altimeter Code	Altimeter Range
2	Precision dual diaphragm, 3 ptr. 80K range cal to 55k
3	Sensitive, 3 ptr., 50,000 ft
5	Sensitive, 3 ptr., 35,000 ft
9	SPECIAL
A	DALT55, Digital 55k feet

2. PHYSICAL DESCRIPTION

The controls, indicators, and other items located in the Front Panel of the Test Set, are described in Figure 4 (this page and the next).

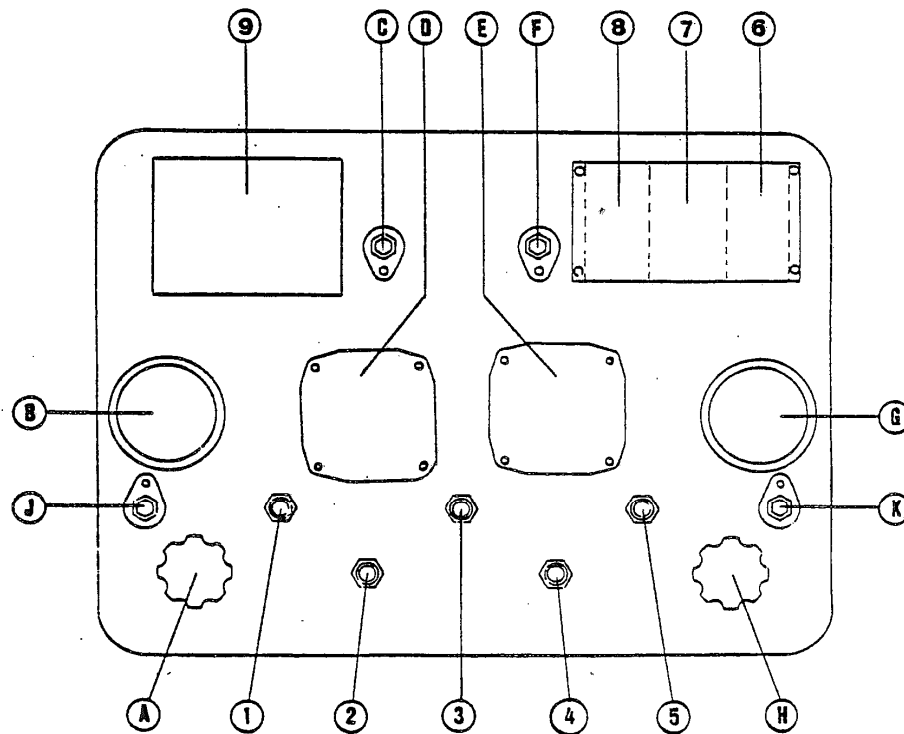

1811D LEADING PARTICULARS

Figure 4

1811D INSTRUCTION MANUAL

ID	ITEM NAME	DESCRIPTION	FUNCTION
A	PRESSURE PUMP	Hand Operated Piston Pump	Integral pressure source for all tests
1	PRESSURE VALVE	Pressure Source Needle Valve	Used to control pressure source
2	PRESSURE VENT	Pressure Vent Needle Valve	Used to release pressure to ambient atmosphere
3	CROSSBLEED VALVE	Crossbleed Needle Valve	Used to control pressure difference between pitot and static
4	VACUUM VENT	Vacuum Vent Needle Valve	Used to release vacuum to ambient atmosphere
5	VACUUM VALVE	Vacuum Source Needle Valve	Used to control vacuum source
H	VACUUM PUMP	Hand Operated Piston Pump	Integral vacuum source for all tests
J	EXTERNAL PRESSURE	1/8-27 NPT Female Bulkhead Fitting	Port for external pressure source
G	VACUUM TANK	0-30 In Hg Vacuum Gauge	Used to monitor vacuum available in vacuum reservoir tank
E	ALTIMETER	--	Monitors pressure altitude at vacuum static side of Test Set
6	CALIBRATION CARD (ALTIMETER)	--	Provides altimeter calibration correction (Only for Analog Indicators)
7	CALIBRATION CARD (HYSTERESIS)	--	Lists altimeter hysteresis at selected altitudes (Only for Analog Indicators)
8	CALIBRATION CARD (AIRSPEED)	--	Provides airspeed calibration correction (Only for Analog Indicators)
F	VACUUM PORT	1/8-27 NPT Female Bulkhead Fitting	Port for connection to aircraft Static System or other vacuum test application
C	PRESSURE PORT	1/8-27 NPT Female Bulkhead Fitting	Port for connection to aircraft Pitot System or other application
D	AIRSPEED INDICATOR	--	Monitors differential pressure in terms of airspeed between pitot and static
9	DECAL	--	Provides instruction for pretesting Test Set
B	PRESSURE TANK	0-30 PSI Pressure Gauge	Monitors pressure available from pressure reservoir tank
K	EXTERNAL VACUUM	1/8-27 NPT Female Bulkhead Fitting	Port for external vacuum source

1811D LEADING PARTICULARS
Figure 4 (continued)



1811D INSTRUCTION MANUAL

THIS PAGE INTENTIONALLY LEFT BLANK



1811D INSTRUCTION MANUAL

SECTION 2: SPECIFICATIONS

Note: Refer to section 5, Inspection Recommendations, and the Engineering Specifications in the Appendix for Specifications and Accuracy Information.

1. PHYSICAL DATA

A. Height:	11.3 (In.)	28.7 (cm.)
B. Width	18.0 (In.)	45.7 (cm.)
C. Depth	12.0 (In.)	30.5 (cm)
D. Weight	18.0 (lbs.)	8.2 (kg)

2. INPUT POWER

The 1811D is hand pump operated. No external power is required. However, when the digital instruments (Barfield DAS650 and DALT55) are installed, battery power is required for their operation.



1811D INSTRUCTION MANUAL

THIS PAGE INTENTIONALLY LEFT BLANK

1811D INSTRUCTION MANUAL

SECTION 3: OPERATION

1. THEORY OF OPERATION

With crossbleed and vent valves closed, the pressure source control needle valve admits pressure from the tank into the system and causes a reaction in both the tester master instrument and the instrument through the pitot connection. The vacuum source control valve, in the same way, controls the vacuum system of the tester. Two vent valves balance their respective systems with atmospheric pressure. A crossbleed valve controls the pressure difference in the pressure and vacuum lines of the tester.

Operating the appropriate valve creates controllable pressure in the Pitot (pressure) and/or Static (vacuum) lines. These pressures appear as readings on the master indicators of the tester. By applying the values listed on the correction cards, the operator can establish a known, correct pressure condition with which to compare the unit being tested.

2. 1811D OPERATIONAL SCHEMATIC DIAGRAM

The following figure shows a rear view of the lines and fittings in the 1811D.

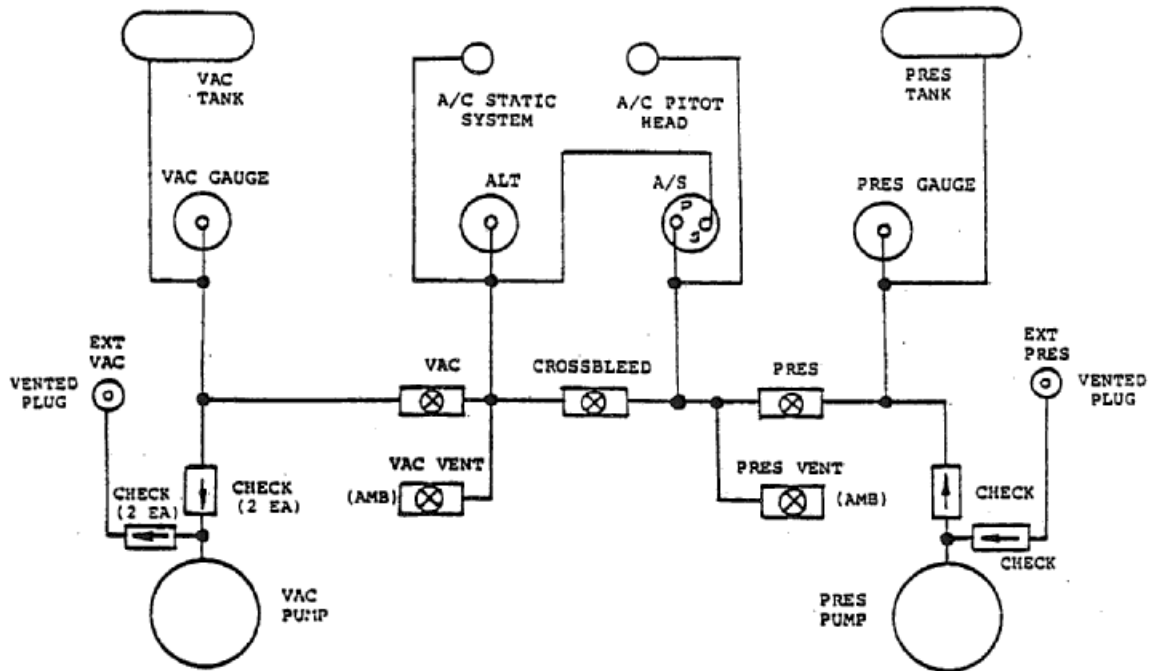

1811D OPERATIONAL SCHEMATIC DIAGRAM
Figure 5

1811D INSTRUCTION MANUAL

3. 1811D PLUMBING SCHEMATIC DIAGRAM

The following figure shows a rear view of the plumbing line and tee fitting connectors for the 1811D.

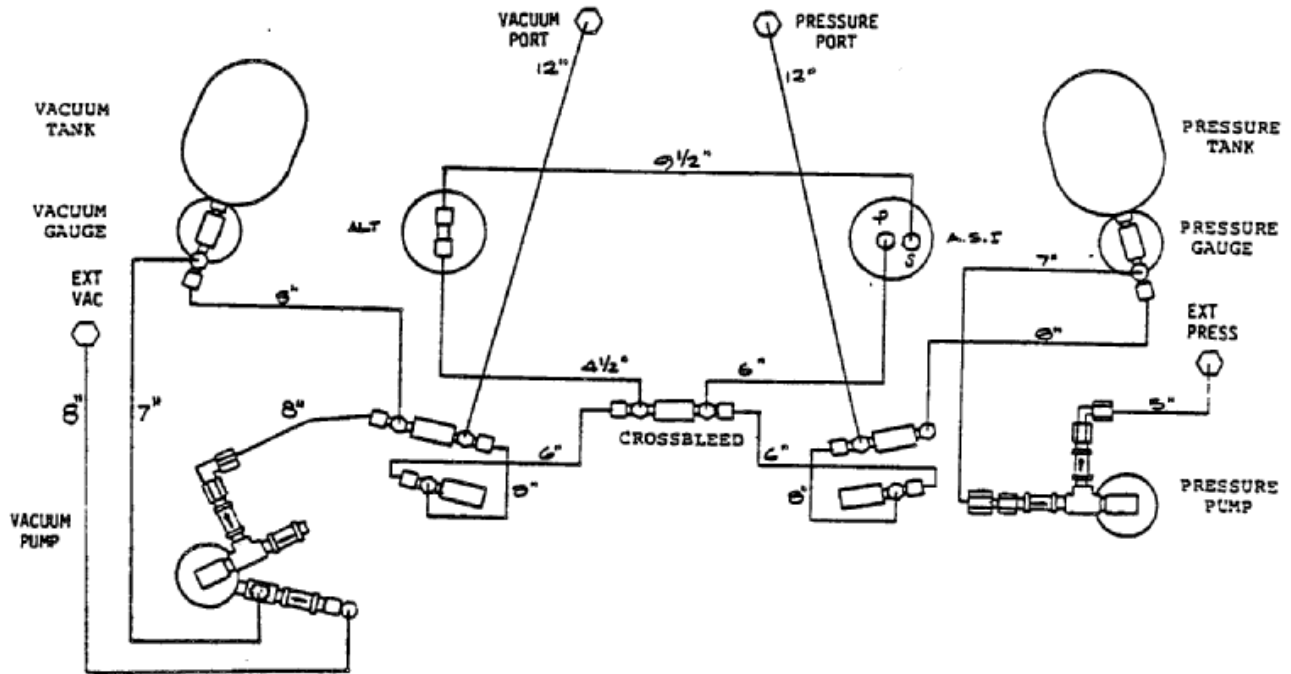

1811D PLUMBING SCHEMATIC DIAGRAM
Figure 6

4. PRELIMINARY

Caution: Do not use unnecessary force to close a Test Set (T/S) valve. New units and units returned to the manufacturer for servicing have been fitted with positive stop spacers on all needle valves to permit the valve to firmly close without damage. However, excessive force may overpower the knob set screw causing valve damage.

To avoid incorrect results or damage to the aircraft or Test Set (T/S) instruments, the manufacturer recommends that the user pay particular attention to the following preliminary procedures. Each T/S is completely calibrated and tested before shipment. However, to ensure the integrity of sensitive tests to be made, the pitot and static system pretests should be done immediately before use. For user convenience, the T/S front panel decal also details these referenced tests.

1811D INSTRUCTION MANUAL

5. PRETESTS

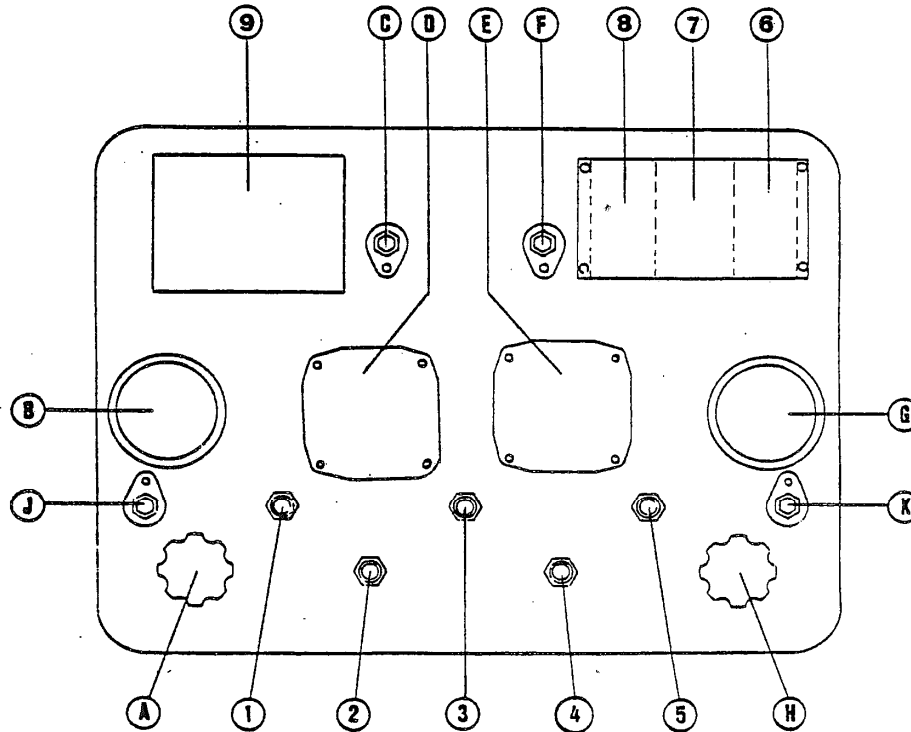

1811D PANEL MOUNTED COMPONENTS
Figure 7

A. Pitot Pretest

Note: Refer to Figure 7 for panel-mounted components referenced by letters and numbers in parentheses.

- (1) Close all ports and valves.
- (2) Pump pressure to 20 psi and vacuum to 20 inHg with PRESSURE pump (#A) and VACUUM pump (#H).
- (3) Open PRESSURE VALVE (#1) until AIRSPEED INDICATOR (#D) shows 300 knots. Close valve and monitor the airspeed for one (1) minute. (Airspeed should not fall more than 2 knots.) Record leak rate.
- (4) Open PRESSURE VENT (#2) valve to return airspeed to ambient pressure. Close valve (#2).

Note: The term “ambient” refers to the existing atmospheric pressure in the area where tests are performed.



1811D INSTRUCTION MANUAL

B. Static Pretest

- (1) Open CROSSBLEED valve (#3) fully.
- (2) Open VACUUM valve (#5) to bring altimeter to 20,000 ft. Close valve and monitor the airspeed for one (1) minute. (Airspeed should not fall more than 2 knots.) Record leak rate.

Note: If necessary, pump additional vacuum.

- (3) Open PRESSURE VENT (#2) valve to return the altimeter to ambient pressure.

Caution: Opening the VACUUM VENT valve (#4) could cause damage to the Airspeed indicator.

C. Applying a Leak Correction

- (1) If the leak rate does not exceed 2 knots or 100 ft in 1 minute, determine the actual aircraft system leak rate by adding the observed rate obtained from a previous aircraft leak test to the recorded rate.

D. Instrument Calibration Correction

Before attempting calibration tests of aircraft instruments, ensure that instrument correction card calibration dates are within the approved recertification periods.

Note: Calibration cards are based on tests performed with instruments vertically mounted (i.e., face up) and at a 75° F (24° C) temperature. A slope of more than 30° from level, and/or a temperature difference of more than ±15° F (±8° C), could affect the precise calibration accuracy.

E. External Pressure and Vacuum

To use the external pressure and vacuum source, remove the vented plugs from ports (#J) and (#K). Install the appropriate connecting fittings and connect them to pressure and vacuum sources. Raise the PRESSURE PUMP handle (#A) before applying external pressure. (The pump handle will rise when external pressure is applied.)

Caution: Do not exceed 20 psi external pressure.

1811D INSTRUCTION MANUAL

6. PITOT SYSTEM TEST

Note: If the aircraft is non-pressurized, the Pitot System and Pitot Leak Tests may be omitted and the Static System Test performed.

A. Pitot System Connection

Using the specific aircraft plumbing diagram, connect the PRESSURE PORT (#C) to the aircraft pitot system. Ensure that the test does not harm the aircraft component.

Caution: Ensure that the connections between the T/S and the aircraft are secure since a sudden break or leak could cause severe instrument damage.

B. Pitot Leak Test

- (1) Ensure that the EXTERNAL PRESSURE (#J) and the EXTERNAL VACUUM (#K) ports are vented.
- (2) Open both the PRESSURE (#2) and the VACUUM (#4) vents fully counterclockwise (CCW).
- (3) Close the PRESSURE (#1), CROSSBLEED (#3) and the VACUUM (#5) valves fully clockwise (CW).
- (4) Operate the PRESSURE PUMP (#A) to obtain 10 psi on the PRESSURE TANK gauge (#B).
- (5) Close the PRESSURE VENT valve (#2).

Note: If any of the following steps fail, close the PRESSURE VALVE (#1) fully CW. Gently open the PRESSURE (#2) vent valve CCW to return the system to ambient atmosphere before disconnecting the T/S.

- (6) Monitor the aircraft and T/S AIRSPEED INDICATOR (#D) while gently opening the PRESSURE valve (#1) until the aircraft airspeed reaches approximately 75% of full range.

Note: The user may compare the aircraft airspeed with the T/S airspeed for calibration by applying T/S calibration card corrections when applicable.

- (7) Close the PRESSURE valve (#1) fully. After the instrument indications stabilize, watch the AIRSPEED INDICATOR (#D) for one minute. The airspeed indicator reading must not decrease by a value greater than 2 kts plus the leak rate (determined previously in the Pitot Pretest) of the Test Set.

Caution: Do not allow the airspeed to fall below its normal resting position of 20 to 40 knots or damage may result to the airspeed indicator.

- (8) Gently open the PRESSURE VENT (#2). (The T/S AIRSPEED INDICATOR (#D) returns to its normal position between 20 and 40 knots.) Then, open the PRESSURE VENT valve (#2) fully.
- (9) Gradually open PRESSURE valve (#1) to bleed off supply.

1811D INSTRUCTION MANUAL

7. STATIC SYSTEM TEST

Caution: If an excessive Pitot Leak rate was detected in the previous test, do not continue until aircraft pitot leak is corrected.

Note: Refer to Figure 7 for number references.

A. Preliminary

Using the specific aircraft plumbing schematic as a guide, connect the VACUUM PORT (#F) to the aircraft Static System.

Note: Ensure that the test will not harm the aircraft component(s).

- (1) If using an external vacuum source, connect it to the EXTERNAL VACUUM port (#K). If not using an external vacuum source, ensure that the EXTERNAL VACUUM port is vented.
- (2) Open both the PRESSURE VENT (#2) and VACUUM VENT (#4) valves fully.
- (3) Close PRESSURE (#1), CROSSBLEED (#3) and VACUUM (#5) valves fully.
- (4) Operate the VACUUM PUMP (#H) or the external pump to develop 20 inHg on the VACUUM TANK gauge (#G).

Note: If the vacuum needs refilling, close the valve (#5) before operating the hand pump.

- (5) Close the VACUUM VENT (#4) fully.
- (6) Set both T/S and aircraft altimeter barometric scales to 29.92 in (or 1013.3 mb). After setting the barometric scales, note the altimeter reading.

8. STATIC LEAK TEST (For Non-Pressurized Aircraft Only)

Note: Using the specific aircraft plumbing diagram, ensure that the pitot aircraft system is connected to the PRESSURE PORT (#C) as referenced in test 6. paragraph A (Pitot System Connection).

Note: When performing the Static Leak Test or if the aircraft airspeed indicator has a range of 150 knots, *do not exceed 1,000 ft increase above field level ambient.* (During the test, both the aircraft and the T/S airspeed indicators increase as the altitude increases.)

Caution: Do not allow the aircraft airspeed to exceed full-scale travel. *If a step fails during testing, close the VACUUM VALVE (#5) fully clockwise.* Then, gently, open the CROSSBLEED VALVE (#3) and return the system to ambient before disconnecting the T/S.

1811D INSTRUCTION MANUAL

A. Leak Test

Caution: Do not exceed aircraft vertical speed indicator (VSI) range while performing the following test.

- (1) Open the VACUUM valve (#5) to produce an altimeter reading of 1,000 ft above the reading noted in test 7. STATIC SYSTEM TEST, paragraph A.(6). Close the valve fully.
- (2) Allow the instrument indications to stabilize. Observe the altimeter (#E) for one minute. Ensure that the altimeter decreases no more than 100 ft plus the leak rate determined from the Static Pretest in test 5, paragraph B.)
- (3) After the test finishes, gradually open the CROSSBLEED valve (#3) to return the system to ambient.
- (4) When the system returns to ambient pressure, open the CROSSBLEED (#3) and VACUUM VENT (#4) valves fully. Disconnect aircraft line from VACUUM port (#F).
- (5) Gradually open the VACUUM valve (#5) to bleed off the vacuum supply. When the VACUUM TANK gauge (#G) returns to zero, close the VACUUM valve (#5) fully.

B. Static Leak Test (Pressurized Aircraft or for an altitude indication of more than 1,000 ft above field level ambient)

(1) Preliminary

Note: Perform all steps described in tests 5. PRETESTS, 6. PITOT SYSTEM TEST, and 7. STATIC SYSTEM TEST first. There must be no significant leakage seen. Verify that all Pitot System tests are satisfactory.

- (a) If using an external vacuum source, connect it to the EXTERNAL VACUUM port (#K). If not, ensure that this port is vented.
- (b) Open the VACUUM VENT (#4) and CROSSBLEED (#3) valves fully. Close all other valves fully.
- (c) Operate the VACUUM PUMP (#H) or the external pump to develop 20 inHg on the VACUUM TANK gauge (#G). If vacuum needs refilling, close the valve (#5) before operating the hand pump.
- (d) Close the VACUUM VENT (#4) fully.

Caution: If any step fails, close the VACUUM VALVE (#5) fully clockwise. Open the PRESSURE VENT valve (#2) to return the system to ambient before disconnecting the T/S.

Note: If the T/S is used outside the aircraft, connect an auxiliary vertical speed indicator (VSI) to the VACUUM PORT (#F) to ensure not exceeding the aircraft VSI range. Verify the aircraft altimeter accuracy by comparing readings with the T/S altimeter with the calibration card corrections applied.

1811D INSTRUCTION MANUAL

C. Negative Altitude Tests

If the test to be done requires altitude readings below field elevation (i.e., above ambient pressure), do the following:

- (1) Open the PRESSURE valve (#1) until the altimeter (#E) reaches the desired test point. Close the PRESSURE valve (#1).

Caution: Do not exceed –1000 ft on the altimeter (#E).

- (2) After the negative altitude test finishes, gently open the VACUUM VENT valve (#4) to return the system to ambient.
- (3) Close VACUUM VENT (#4) fully.

D. Leak Test

Caution: Do not exceed the aircraft VSI full scale range during the test.

- (1) Open the VACUUM valve (#5) until the altimeter reaches the desired reading. Close the VACUUM valve (#5) fully. (If the vacuum needs refilling, close the VACUUM valve (#5) before operating the hand pump.)
- (2) Allow all instruments to stabilize. Monitor the T/S altimeter (#E) for one (1) minute and ensure that the altimeter reading decreases no more than 100 ft or 2% of the indicated altitude whichever is greater.

Note: If the system shows a leak, carefully watch the T/S AIRSPEED INDICATOR (#D). When airspeed pointer movement is seen, open the CROSSBLEED valve (#3). Then, gradually close the CROSSBLEED valve (#3).

Caution: Allowing the airspeed to go lower than 10 knots may result in severe damage to aircraft components or the T/S.

- (3) If the airspeed pointer indication increases, the leak is in the Pitot system. If the indication decreases, the leak is in the Static system. Return the CROSSBLEED valve (#3) to full open.

Caution: Do not exceed the aircraft VSI full-scale range.

- (4) When the test finishes, gradually open the PRESSURE VENT (#2) to return system to ambient.
- (5) When system returns to ambient pressure, open the PRESSURE VENT (#2) and VACUUM VENT (#4) fully. Disconnect the aircraft lines from the PRESSURE (#C) and VACUUM (#F) ports.
- (6) Gradually open the VACUUM (#5) and PRESSURE (#1) valves to bleed off supply tanks.
- (7) When the PRESSURE TANK (#B) and the VACUUM TANK (#G) return to zero, close the PRESSURE (#1) and VACUUM (#5) valves fully.

1811D INSTRUCTION MANUAL

9. Combined Pitot (Airspeed) / Static (Altitude) Test

The following procedure is valid for machmeters, engine pressure ratio indicators, and flight recorders.

Caution: Perform the following test in exact order presented.

A. Preliminary

- (1) Perform all steps described in tests 5. PRETESTS, 6. PITOT SYSTEM TEST, 7. STATIC SYSTEM TEST, and 8. STATIC LEAK TEST (For Non-Pressurized Aircraft Only) first. Correct any leaks found.
- (2) Using the specific aircraft-plumbing diagram, connect the PRESSURE PORT (#C) to aircraft pitot system (Hi port) and the VACUUM PORT (#F) to aircraft static system (Lo port).

Caution: Ensure the test does not harm components in the aircraft system.

- (3) Close all T/S valves. Operate the PRESSURE PUMP (#A) to develop 10 psi. Operate the VACUUM PUMP (#H) to develop 20 inHg.
- (4) Verify that the T/S and the aircraft altimeters are set to 29.92 inHg (1013.3 mb).

B. Below Field Elevation Test

Note: If there are no altitude tests below field elevation, this test may be omitted.

- (1) Open the CROSSBLEED (#3) valve fully. While ensuring not to exceed the aircraft VSI full-scale range, gently open the PRESSURE valve (#1) to reach the desired downscale altimeter test point. Once reaching the test point, close the PRESSURE (#1) and CROSSBLEED (#3) valves fully.
- (2) Taking care not to exceed the test point, carefully open the PRESSURE (#1) valve until the AIRSPEED INDICATOR (#D) increases to the desired test point.

Note: The airspeed test point may only be set above the normal resting position of the pointer.

Note: If an airspeed test point is accidentally exceeded, gently open the CROSSBLEED (#3) valve until the airspeed is 10 knots below the desired test value. (Some altitude change occurs.) Gently open the VACUUM (#5) valve to restore the altitude (#E) to a correct test point. Raise the airspeed to the test point by carefully opening the PRESSURE (#1) valve until reaching the desired airspeed. Repeat procedure to complete the higher airspeed test points. Once done, gently open the CROSSBLEED (#3) valve and return the AIRSPEED INDICATOR (#D) to its normal pointer rest position of 20 to 40 knots. Then, close CROSSBLEED (#3) valve.

1811D INSTRUCTION MANUAL

C. Above Field Elevation Tests

Caution: Perform test in the exact order and method listed. Avoid instrument damage or going above a test point by operating valves gently and going from one test point to the other gradually. *Do not exceed the VSI range while doing this test.*

Note: User skill is necessary for the following tests to adjust the metering valve settings and to maintain the desired instrument readings.

- (1) Open the VACUUM (#5) valve and increase the airspeed to approximately 10 knots below the desired test point.
- (2) Open the CROSSBLEED (#3) to maintain the airspeed below the test point until reaching the desired altitude. Close both valves.

Note: If the altitude will no longer increase, close the VACUUM and the CROSSBLEED valves and operate the VACUUM PUMP (#H) to create more vacuum.

- (3) Once reaching the test altitude with valves closed, gently open the PRESSURE valve (#1) to take the airspeed to the test point.
- (4) Gently open the PRESSURE valve (#1) so that the airspeed goes to 10 knots *below* the next higher airspeed test point.

Note: To correct the altitude *upward*, operate the VACUUM (#5) valve. To lower the altitude, operate the VACUUM VENT (#4) valve.

- (5) Use the PRESSURE (#1) valve to increase airspeed until it is exactly at the desired test point.
- (6) Repeat steps (4) thru (5) for each higher airspeed test point until reaching the highest desired airspeed value at this altitude.
- (7) After the highest airspeed value at this altitude, select the lowest airspeed to be tested at the next higher altitude.
- (8) Open the CROSSBLEED (#3) valve to reduce the airspeed 10 knots below the next test point.
- (9) Raise the altitude to the next test point by opening the VACUUM (#5) valve. (Use the CROSSBLEED valve to maintain airspeed below the test point.) Once reaching the desired altitude, close both valves.
- (10) Repeat steps (3) through (9) until completing all airspeed points at each desired altitude.
- (11) Perform steps listed in test 9, part D and return system to ambient.

1811D INSTRUCTION MANUAL

D. Returning the Pitot / Static Test Set to Ambient

Caution: Perform the following test in exact order given.

- (1) Gently open the CROSSBLEED (#3) valve until AIRSPEED INDICATOR (#D) returns to a normal rest position of 20 to 40 knots. Open valve fully.
- (2) Monitor the VSI. Open the PRESSURE VENT (#2) valve. *Do not exceed the VSI scale range.*

Caution: Do not use the VACUUM VENT (#4) to bleed system. Severe instrument damage could result.

- (3) Once the altimeter (#E) reaches ambient pressure and there is no further decrease in the altitude indication, open the PRESSURE VENT (#2) and VACUUM VENT (#4) fully.
- (4) Open the PRESSURE valve (#1) and VACUUM valve (#5) to bleed pressure and vacuum as indicated by the appropriate pressure or vacuum gauge (#B or #G).

1811D INSTRUCTION MANUAL

10. MACHMETER TEST

A. Test Procedure

- (1) Set an altitude (in feet) as referenced in the following table. Set the corresponding airspeed (in knots). Verify that the MACH value obtained is the same as listed in the table for the settings. (For example, an altitude set to 10k with airspeed of 277 kts would give a MACH reading of .50.)

MACH NUMBER								Altitude (In feet)
.50	.60	.70	.75	.80	.82	.85	.90	
277	334	391	420	449	---	---	---	10k
247	298	350	376	403	414	429	---	15k
228	275	324	348	373	383	398	424	20k
205	248	292	315	338	347	361	384	25k
188	228	269	289	311	319	332	354	29k
172	207	246	265	285	292	304	324	33k
157	190	224	242	260	267	278	297	37k
142	173	204	220	237	243	253	277	41k
---	157	186	201	216	222	231	246	45k
---	143	169	183	196	202	210	225	49k
---	---	161	174	187	193	201	214	51k

↑

Airspeed
(In kts)

↓

**Airspeed vs. MACH Number
TABLE 1**

1811D INSTRUCTION MANUAL

11. ENGINE PRESSURE RATIO (EPR) TEST

A. Test Procedure

- (1) Connect the PRESSURE PORT (#C) to the Pt7 (Hi) port of EPR to be tested.
- (2) Connect the VACUUM PORT (#F) to Pt2 (Lo) port of EPR to be tested.
- (3) Using the methods described in test 9. COMBINED PITOT (AIRSPEED) / STATIC (ALTITUDE) TEST, refer to Table 2 and set up altitude and airspeed combinations.

AIRSPEED (knots) Pt7 (Hi) Port	ALTITUDE (feet) Pt2 (Lo) Port	EPR (Engine Pressure Ratio)
650	25, 870	3.4
546	35,000	3.4
650	21,650	3.0
504	35,000	3.0
650	14,690	2.5
534	25,870	2.5
444	35,000	2.5
650	4,210	2.0
500	20,000	2.0
369	35,000	2.0
478	5,000	1.5
365	20,000	1.5
265	35,000	1.5

**Engine Pressure Ratio Test Table
TABLE 2**

12. MANIFOLD PRESSURE GAUGE TEST

A. Test Procedure

- (1) Plug or cap PRESSURE PORT (#C).
- (2) Connect VACUUM PORT (#F) to manifold gauge to be tested.
- (3) Close all T/S valves. Open the CROSSBLEED valve (#3) fully and maintain it open.
- (4) Verify that the altimeter (#E) is set at 29.92 inHg (1013.3 mb).
- (5) Operate the VACUUM PUMP (#H) and the PRESSURE PUMP (#A) as necessary.

1811D INSTRUCTION MANUAL

- (6) Refer to the following table for the appropriate altitude and inHg manifold pressure readings.

ALTITUDE (feet)	MANIFOLD PRESSURE (inHg)
-985	31
-75	30
860	29
1,825	28
2,815	27
3,835	26
4,890	25
10,730	20
17,905	15
27,375	10

**Altitude vs. Manifold Pressure
Table 3**

Note: For test points below field elevation, gradually open PRESSURE (#1) valve; for test points above field elevation, open the VACUUM (#5) valve.

- (7) Close the PRESSURE (#1) AND VACUUM (#5) valves (and if necessary, use the PRESSURE VENT valve (#2) to bleed system) and return system to ambient.

13. LOW PRESSURE TEST

Note: The following test uses 0-12 PSI, 0-25 inHg or 1-340 inH₂O ranges.

A. Test Procedure

- (1) Connect the PRESSURE PORT (#C) to the pressure unit to be tested. (The Vacuum port (#F) is not used.)
- (2) Close all T/S valves. Open the VACUUM VENT (#4) valve fully and maintain open for remainder of this test.
- (3) Operate the PRESSURE PUMP (#A) as necessary.

1811D INSTRUCTION MANUAL

- (4) Open the PRESSURE (#1) valve gradually. Set up the desired airspeed value for the equivalent pressure. (Refer to Table 4 below.)

Airspeed	Inches Water	Inches Mercury	Pounds Sq. In.	Airspeed	Inches Water	Inches Mercury	Pounds Sq. In.
39	1.000	0.073	0.036	285	55.416	4.072	2.000
55	2.000	0.146	0.072	314	68.045	5.000	2.466
68	3.000	0.220	0.108	342	81.654	6.000	2.947
78	4.000	0.294	0.144	355	83.124	6.108	3.000
87	5.000	0.367	0.180	368	95.263	7.000	3.438
96	6.000	0.441	0.216	391	108.872	8.000	3.929
103	7.000	0.514	0.252	395	110.832	8.144	4.000
110	8.000	0.587	0.289	413	122.481	9.000	4.420
117	9.000	0.661	0.325	433	136.090	10.000	4.912
123	10.000	0.734	0.361	437	138.540	10.180	5.000
135	12.000	0.881	0.433	470	163.308	12.000	5.894
144	13.609	1.000	0.481	474	166.248	12.216	6.000
146	14.000	1.028	0.505	504	190.526	14.000	6.876
155	16.000	1.175	0.577	508	193.955	14.252	7.000
165	18.000	1.322	0.649	534	217.744	16.000	7.859
174	20.000	1.468	0.721	538	221.663	16.288	8.000
194	25.000	1.836	0.901	561	244.962	18.000	8.841
203	27.218	2.000	0.982	565	249.371	18.324	9.000
204	27.707	2.036	1.000	587	272.180	20.000	9.823
212	30.000	2.202	1.082	591	277.079	20.360	10.000
229	35.000	2.570	1.262	611	299.398	22.000	10.806
244	40.000	2.937	1.443	615	304.787	22.396	11.000
246	40.827	3.000	1.473	633	326.616	24.000	11.788
258	45.000	3.304	1.623	638	332.495	24.432	12.000
271	50.000	3.671	1.803	644	340.225	25.003	12.279
283	54.436	4.000	1.965				

Airspeed Equivalent (knots) for Differential Pressure / Vacuum
Table 4

Note: To lower the airspeed reading or to return the system to ambient, gradually open the PRESSURE VENT (#2) valve.

1811D INSTRUCTION MANUAL

14. VACUUM TEST

Note: The following test uses 0-12 PSI, 0-25 inHg or 1-340 inH₂O ranges.

A. Test Procedure

(Refer to Table 4 for equivalent airspeed readings.)

- (1) Connect the VACUUM PORT (#F) to the vacuum unit to be tested.

Note: The PRESSURE PORT (#C) is not used.

- (2) Close all T/S valves. Open the PRESSURE VENT (#2) fully and maintain open for the rest of the procedure.
- (3) Operate the VACUUM PUMP (#H) as required.

Note: The altimeter (#E) operates during this test, but the readings are not used. Also, test sets with a 35,000 ft altimeter range have a slightly reduced test range.

Caution: If using test sets with a 35,000 ft altimeter range, do not exceed 35,000 ft.

- (4) Set the AIRSPEED INDICATOR (#D) reading for the desired vacuum listed in Table 4 by gradually opening the VACUUM valve (#5).
- (5) Open the VACUUM VENT valve (#4) to lower the airspeed reading or to return to ambient.

SECTION 4: VALVE LEAK TEST

1. METERING VALVE ADJUSTMENT PROCEDURE

Note: The following procedure is also released as IM150 (dated 7/6/88.)

A. VALVE LEAK TEST

Caution: Before performing the Valve Leak test, inspect for system or instrument leakage. (Refer to the appropriate Aircraft Maintenance Manual for information and proper procedure.)

Note: Read this section in its entirety (parts 1 and 2), before performing test since all these steps must be done in combination when performing valve adjustments.

B. PRESSURE VALVE TEST

- (1) Close all valves except VACUUM VENT (#4).
- (2) Plug PRESSURE (#C) and VACUUM (#F) ports (single action pumps only).
- (3) Pressurize PRESSURE TANK (#B) to 15 PSI.
- (4) Monitor AIRSPEED INDICATOR (#D) for one (1) minute.
 - (a) If an increase in airspeed is seen, continue to monitor for an additional five (5) minutes.
 - (b) If during the monitoring period the airspeed increase exceeds five (5) knots, a leak exists at the PRESSURE valve (#1).
- (5) Correct leak before continuing. Refer to subsection 2. RESETTING NEEDLE VALVE POSITIVE STOP.

C. PRESSURE VENT AND CROSSBLEED VALVE TEST

- (1) Close all valves except VACUUM VENT (#4).
- (2) For single action pumps, plug the PRESSURE (#C) and VACUUM (#F) ports.

Caution: Do not over pressurize the airspeed indicator.

- (3) Apply enough pressure to the PRESSURE TANK (#B) to provide full scale travel of the AIRSPEED INDICATOR (#D).
- (4) Gently open the PRESSURE valve (#1). Increase the airspeed to full scale.
 - (a) Close PRESSURE valve (#1).
 - (b) Monitor the AIRSPEED INDICATOR (#D) for one (1) minute. If there is a decrease of more than two (2) knots, a leak exists at the PRESSURE VENT (#2) or CROSSBLEED (#3) valves.

1811D INSTRUCTION MANUAL

- (c) Fully close the VACUUM VENT (#4) and monitor both AIRSPEED INDICATOR (#D) and ALTIMETER (#E):
- If the ALTIMETER moves down scale, the leak is located at the CROSSBLEED valve (#3).
 - If the ALTIMETER does not move but the airspeed continues to decrease, the leak is located at the PRESSURE VENT valve (#2).
- (d) Correct leak(s) before continuing. Refer to subsection 2. RESETTING NEEDLE VALVE POSITIVE STOP.

D. VACUUM VENT TEST

- (1) Close all valves except CROSSBLEED valve (#3).
- (2) If using single action pumps, plug the PRESSURE (#C) and VACUUM (#F) ports.
- (3) Empty the VACUUM TANK gage (#G) to at least 20 inches.
- (4) Monitor the ALTIMETER (#E) for one (1) minute. An increase in the ALTITUDE means the leak is located at the VACUUM valve.
- (5) Correct the leak before continuing. Refer to subsection 2. RESETTING NEEDLE VALVE POSITIVE STOP.

E. VERTICAL SPEED VALVE TEST

- (1) Close all valves except the CROSSBLEED (#3).
- (2) If using single action pumps, plug the PRESSURE (#C) and VACUUM (#F) ports.
- (3) Empty and maintain the VACUUM TANK gage (#G) at 20 inches.
- (4) Gently open the VACUUM valve (#5).
- (5) Increase the altitude to 20,000 ft while monitoring the VERTICAL SPEED indicator. An increase in the VERTICAL SPEED means the leak is located at the VERTICAL SPEED valve.
- (6) Correct the leak before continuing. Refer to subsection 2. RESETTING NEEDLE VALVE POSITIVE STOP.

F. VACUUM VENT VALVE TEST

- (1) Close all valves except CROSSBLEED (#3).
- (2) If using single action pumps, plug PRESSURE (#C) and VACUUM (#F) ports.
- (3) Empty and maintain VACUUM TANK gage (#G) at 20 inches.
- (4) Gently open the VACUUM valve (#5).
 - (a) Increase the altitude to 20,000 ft.
 - (b) Close VACUUM valve (#5).
- (c) Monitor ALTIMETER for one (1) minute. An increase of altitude of more than 100 ft. means the leak is located at the VACUUM valve.
- (5) Repair leak before continuing. Refer to subsection 2. RESETTING NEEDLE VALVE POSITIVE STOP.

1811D INSTRUCTION MANUAL

2. RESETTING NEEDLE VALVE POSITIVE STOP

Caution: Before performing the Valve Leak Test or Resetting the Needle Valve Positive Stop, inspect the entire system for leaks at locations other than valve seats, i.e., connections, general plumbing and instruments.

Positive stop spacers are installed on some models to provide a “positive stop” which allows a firm closing of the valves without damaging the valve needles or their seats. On other models, the valve body provides this stop. The positive shut-off is carefully set and adjusted during the manufacturer or factory recalibration. However, if the valves develops a slight leak from repeated use, do the following steps to reset:

Caution: Except for the pressure and vacuum control valves, any leak seen could be from a source other than the valves. Do not tighten any valve beyond the closing point described below. When it is determined that a valve is leaking, correct the leak before continuing.

A. Firmly close the valve against its positive stop.

- (1) With a 5/64" (.078") hex wrench, loosen the knob setscrew.
- (2) Raise the knob approximately 1/32" above the valve body or spacer. Retighten the setscrew.
- (3) Gently turn the knob clockwise while ensuring not to exceed one quarter (1/4) rotation, or until positive resistance is felt.

Caution: Do not exceed one half (1/2) rotation. If the leak persists, the leak is located elsewhere or the valve is defective.

- (4) If doing step (2) above stopped leakage, loosen the knob setscrew and remove knob.

Note: If spacers are installed, do not remove them.

- (5) Locate the setscrew mark, on the valve stem.
- (6) Align the setscrew to a new location.
- (7) Push the knob firmly down against the valve body or spacer and hold down while tightening the setscrew.
- (8) Open valve one quarter (1/4) rotation, and then close firmly. (A “positive shut” off should now exist.)

B. If a leak persists, continue testing, and resetting or replacing remaining valves, until no leakage occurs.



T A T G R O U P

1811D INSTRUCTION MANUAL

THIS PAGE INTENTIONALLY LEFT BLANK

SECTION 5: INSPECTION RECOMMENDATIONS

1. REQUIRED INSPECTION

The manufacturer recommends that maintenance and lubrications be performed in the following inspection periods:

TIME PERIOD	INSPECTION REQUIRED
With Each Use	Leak Test (Refer to Section 3, tests 6. PITOT SYSTEM TEST, and 7. STATIC SYSTEM TEST)
6 Months	For analog instrument configuration(s), inspect altimeter, hysteresis and airspeed for scale error at room temperature. (Refer to Engineering Specifications in Appendix of this manual.) Rewrite calibration card if necessary.
12 Months	For digital instrument (-A0A) configuration, refer to documents 61-101-02184 (DALT55) and 61-101-02194 (DAS650), for specifications and recertification intervals.
12 Months	All of the preceding Plus: Check Pressure and Vacuum gauges for friction and leaks. Regarding leaks, ensure the pressure gauge and related internal plumbing can maintain 15 psi for 5 minutes with losing more than 1 psi and the vacuum gauge should maintain 20 inHg vacuum for 5 minutes without losing more than 1 inHg of vacuum. Regarding friction, ensure both the pressure gauge and vacuum gauge pointers transition smoothly without sticking. Check vacuum and pressure hand pumps for capacity. The pressure hand pump should be able to achieve a minimum of 15 psi and the vacuum hand pump should be able to achieve a minimum of 20 inHg of vacuum.

**Required Periodic Inspections
Table 5**



1811D INSTRUCTION MANUAL

THIS PAGE INTENTIONALLY LEFT BLANK



1811D INSTRUCTION MANUAL

SECTION 6: SHIPPING

Use standard delicate electronic equipment packaging procedure when packing the Test Set for reshipment.

To prevent damage from extreme atmospheric changes to the Test Set instruments, it is recommended that the STATIC VENT, CROSSBLEED CONTROL, AND PITOT VENT VALVES be in open position. VERTICAL SPEED, PITOT CONTROL, AND STATIC CONTROL VALVES should be closed.



1811D INSTRUCTION MANUAL

SECTION 7: STORAGE

1. PROCEDURES

- A. Place a 4-oz bag of desiccant inside the container.
- A. Close and latch the cover.
- B. Store in a cool dry place.

Note: Should the Test Set become exposed to moisture or very high humidity, dry it as soon as possible and store temporarily in a dehumidified area.

- C. To prevent damage from extreme atmospheric changes to the Test Set instruments, it is recommended that the STATIC VENT, CROSSBLEED CONTROL, AND PITOT VENT VALVES be open. VERTICAL SPEED, PITOT CONTROL, AND STATIC CONTROL VALVES should be closed.



1811D INSTRUCTION MANUAL

APPENDIX

BARFIELD INC. ENGINEERING SPECIFICATIONS

Note: For information on compliance with FAR 91-411, refer to Barfield document, 60-101-00150.

SECTION 1: ALTIMETER

SECTION 2: AIRSPEED INDICATOR

SECTION 3: VERTICAL SPEED INDICATOR



1811D INSTRUCTION MANUAL

SECTION 1. ALTIMETER

The following engineering specification (Document No 23-338-00001) details the performance requirements of the pressure sensitive altimeters used by Barfield, Inc. to manufacture ground support test equipment.

Engineering Specification	
Title: Altimeter, Ground Support Equipment	Barfield, Inc 4101 NW 29 Street Miami Florida 33142
Drawing No: 23-338-00001	Page 1 of 5

REV.	ECO #	REV. DATE	DESCRIPTION OF CHANGE
A	N/A	Dec/19/1989	Initial Release
B	260-00780	July/24/1991	Addition of Dual Baro 35k & 50k Ft United Altimeter, P/N 59TD & 5934AD-1 respectively
C	260-00885	Jan/19/2012	Document reformatted to MS Word. Section 3 Updated.

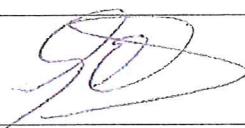
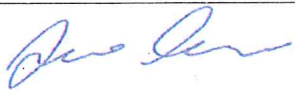
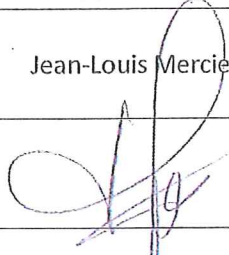
	Created By	Checked By	Approved By
Name	Guillermo Echarri	Jesus Armas	Jean-Louis Mercier
Signature			
Date	1/19/2012	1/19/2012	1/19/2012

Engineering Specification	
Title: Altimeter, Ground Support Equipment	Barfield, Inc 4101 NW 29 Street Miami Florida 33142
Drawing No: 23-338-00001	Page 2 of 5

1. Purpose:

To specify performance requirements for Pressure Sensitive Altimeters for use in B.I.C. manufactured ground support test equipment.

2. Scope:

This PRODUCT STANDARD SPECIFICATION covers two basic types of instruments as follows:

TYPE I - Range 35,000 ft. Barometric Pressure. Scale range at least 28.1 - 30.99 inches of Mercury (946-1049 millibars). May include markers working in conjunction with the Barometric Pressure Scale to indicate pressure - altitude.

TYPE II - Range 50,000 ft. Barometric Pressure. Scale range at least 28.1 - 30.99 inches of Mercury (946-1049 millibars). May include markers working in conjunction with Barometric Pressure Scale to indicate pressure - altitude.

3. Identification:

All units regardless of origin of manufacture are to be identified by B.I.C. assigned part numbers as follows:

B.I.C. P/N	Baro. Units	TYPE NO.	RANGE
124-00001 *	in.Hg Baro	II	50,000 FT
124-00002	in.Hg Baro	II	55,000 FT
124-00003	Dual Baro	II	50,000 FT
124-00004	in.Hg Baro	I	35,000 FT
124-00005	Dual Baro in.Hg/mb	I	35,000 FT
124-00006 *	mb Baro	II	50,000 FT
124-00007 *	mb Baro	I	35,000 FT
124-00008 *	in.Hg Baro	II	50,000 FT (OXYGEN ONLY)

Note: "*" indicates service only, not available.

4. Test Conditions:

Unless otherwise specified, all tests shall be made with the instrument mounted in the horizontal (Face UP) position.

Engineering Specification	
Title: Altimeter, Ground Support Equipment	Barfield, Inc 4101 NW 29 Street Miami Florida 33142
Drawing No: 23-338-00001	Page 3 of 5

5. Performance Requirements:

All units are required to meet the following performance requirements before installation in any ground support test equipment.

5.1 Case Leak:

A pressure equivalent to 18,000 ft. within the case shall not result in leakage exceeding 20 ft (100 ft when installed in Test Set) per minute.

5.2 Friction:

The instrument shall be tested for friction at varied readings of the scale. The instrument shall be subjected to a steady rate of decreasing pressure equivalent to about 750 ft per minute. The change in reading of the pointers due to vibrating the instrument at each of the altitudes specified in table-1 is to be recorded as friction and shall not exceed the tolerances listed.

ALTITUDE (FEET)	TOLERANCE (FEET ±)
1,000	70
2,000	70
3,000	70
5,000	80
10,000	90
15,000	100
20,000	125
25,000	150
30,000	175
35,000	200
40,000	250
50,000	400

TABLE 1 FRICTION

5.3 Hysteresis:

Not more than 15 minutes after the altimeter has been first subjected to the pressure corresponding to the upper limit of the scale (ref. table-2 or 3 as applicable), test point -2- , the pressure shall be increased at a rate corresponding to a decrease in altitude of approximately 3,000 feet per minute until the pressure corresponding to test point -3- is reached. Within 10 seconds the instrument shall indicate within 100 feet of the test reading. The altimeter shall remain at this pressure for at least 5 minutes but not more than 15 minutes before the test reading is taken. After the reading has been taken, the pressure shall be further increased at the above rate until the pressure corresponding to test point -4- is reached. The altimeter shall remain at this pressure for at least one minute but not more than 10 minutes before

Engineering Specification	
Title: Altimeter, Ground Support Equipment	Barfield, Inc 4101 NW 29 Street Miami Florida 33142
Drawing No: 23-338-00001	Page 4 of 5

the test reading is taken. After the reading has been taken, the pressure shall be further increased at the above rate until atmospheric pressure is reached. The reading of the altimeter at either of the two test points shall not differ from the reading of the altimeter for the corresponding altitude in the scale error test by more than the tolerance specified in the corresponding table. For a TYPE-I instrument use Table-2, TYPE-II use Table-3.

TEST POINT	ELEVATION (FEET)	TIME Min/Max	ALLOWABLE ERROR (FT)
1	0	---	---
2	35,000	-- /15	---
3	18,000	5/15	70
4	14,000	1/10	70
* 5	0	- / 5	50

TABLE 2 HYSTERESIS / - TYPE – I

TEST POINT	ELEVATION (FEET)	TIME Min/Max	ALLOWABLE ERROR (FT)
1	0	---	---
2	50,000	-- /15	---
3	25,000	5/15	150 {100}
4	20,000	1/10	150 {100}
* 5	0	- / 5	60 { 50}

TABLE 3 HYSTERESIS - TYPE – II

- Note: a) * Test point 5 is the "After Effect" specification.
b) The values in Table-3 enclosed in "{}" are applicable against the 124-00002 instrument.

5.4 After Effect:

Not more than 5 minutes after the completion of the hysteresis test, the pointers shall have returned to their original reading, corrected for any change in atmospheric pressure to within the tolerance specified by test point -5- in the corresponding table. For a TYPE-I instrument use Table-2, TYPE-II use Table-3.

5.5 Scale Error:

For a period of not less than twelve hours prior to this test the altimeter shall not have been operated at pressures other than ambient. The barometric scale shall be set at 29.92 inches of mercury and the scale error recorded. Without changing the baro setting, the altimeter shall be subject successively to the pressure specified in Table-4. The reduction in pressure shall be made at a rate not in excess of 20,000 feet per minute to within approximately 2,000 feet of the test point. The test point shall be approached at a rate compatible with the test equipment. The altimeter shall remain at the pressure corresponding to each test point for at least 1 minute but no more than 10 minutes before a reading is taken. The error at all test points shall not exceed the tolerances specified in Table-4 or Table-5 as applicable.

Engineering Specification

Title: Altimeter, Ground Support Equipment	Barfield, Inc 4101 NW 29 Street Miami Florida 33142
Drawing No: 23-338-00001	Page 5 of 5

ALTITUDE (FEET)	ALTIMETER ERROR ±
-1,000	40
0	40
500	40
1,000	40
1,500	50
2,000	60
3,000	60
4,000	70
6,000	80
8,000	120
10,000	160
12,000	200
14,000	225
16,000	240
18,000	275
20,000	300
22,000	340
25,000	375
30,000	450
35,000	525
40,000	600
45,000	675
50,000	750

TABLE 4 Scale Error

ALTITUDE (FEET)	ALTIMETER ERROR ±
-1,000	20
0	20
500	20
1,000	20
1,500	25
2,000	30
3,000	30
4,000	35
6,000	40
8,000	60
10,000	80
12,000	90
14,000	100
16,000	110
18,000	120
20,000	130
22,000	140
25,000	155
30,000	180
35,000	205
40,000	230
45,000	255
50,000	280
55,000	600

TABLE 5 Scale Error

Note: Table 4 Applicable against: 124-00001, 124-00003, 124-00004, 124-00005, 124-00006, 124-00007, 124-00008

Table 5 Applicable against: 124-00002



1811D INSTRUCTION MANUAL



SECTION 2. AIRSPEED INDICATOR

The following engineering specification (*Barfield Document No. 23-336-00025*) details the performance requirements of the pitot static pressure type airspeed indicators used by Barfield, Inc. to manufacture ground support test equipment.

Engineering Specification

Title: Airspeed, Ground Support Equipment	Barfield, Inc 4101 NW 29 Street Miami Florida 33142
Drawing No: 23-336-00025	Page 1 of 5

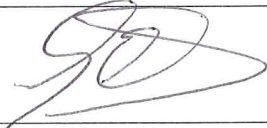
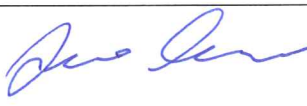
REV.	ECO #	REV. DATE	DESCRIPTION OF CHANGE
A	N/A	Jan/8/1990	Initial Release
B	260-00885	Jan/20/2012	Document reformatted to MS Word. Section 3 Updated.

	Created By	Checked By	Approved By
Name	Guillermo Echarri	Jesus Armas	Jean-Louis Mercier
Signature			
Date	1/19/2012	1/19/2012	1/19/2012

Engineering Specification	
Title: Airspeed, Ground Support Equipment	Barfield, Inc 4101 NW 29 Street Miami Florida 33142
Drawing No: 23-336-00025	Page 2 of 5

1. Purpose:
To specify performance requirements for Pitot Static Pressure Type of Airspeed Indicators for use in B.I.C. Manufactured ground support test equipment.

2. Scope:
This Product STANDARD SPECIFICATION covers two (2) basic types of airspeed indicators with indication range essentially as follows:

TYPE I - 1 Revolution
TYPE II - 7 Revolutions

3. Identification:
All units regardless of origin of manufacture are to be identified by B.I.C. assigned part numbers as follows:

B.I.C. P/N	TYPE NO.	RANGE
336-00001R	II	50 - 650 Knots
336-00001	II	50 - 650 Knots
336-00004	I	60 - 420 Knots
336-00005	I	40 - 200 Knots
336-00006	I	20 - 250 Knots

4. Test Conditions:
Unless otherwise specified, all tests shall be made with the instrument mounted in the horizontal (Face UP) position.

5. Performance Requirements:
All units are required to meet the following performance requirements before installation in any ground support test equipment.

5.1 Friction:
The instrument shall be tested for friction at approximately four essentially equal scale intervals. The pressure shall be brought up to the desired reading and then held constant while two readings are taken. The first reading being taken before the instrument is vibrated, and the second one after the instrument is vibrated. The difference between any two readings shall not exceed any of the tolerances listed in the calibration specifications.

5.2 Leak:
With both the pitot pressure and static pressure connections simultaneously evacuated to 15 inches of Mercury, the leakage shall not cause more than 0.4 inch of mercury pressure drop during a 10 second period.

Engineering Specification	
Title: Airspeed, Ground Support Equipment	Barfield, Inc 4101 NW 29 Street Miami Florida 33142
Drawing No: 23-336-00025	Page 3 of 5

5.3 Vibration:

With pressure applied, sufficient to give half scale deflection, the instrument shall be subjected to vibrations of all frequencies within the appropriate ranges specified.

5.4 Pointer Position:

The position of the pointer without any pressure applied shall rest on the lowest airspeed on the dial with the exception of P/N's 336-00001,336-00001R and 336-00004. The 336-00001 & ..1R units pointer should rest between 15-45 knots. The 336-00004 unit pointer position should rest at $350^{\circ} \pm 5^{\circ}.0$ position; (12 o'clock being the 360° position.)

6. Scale Error Test:

All units shall be tested to the following specifications.

6.1 P/N 336-00001&1R:

READING (Knots)	TOLERANCE (Knots)	READING (Knots)	TOLERANCE (Knots)
50	± 5.0	220	± 4.0
60	± 3.0	240	± 4.0
70	± 3.0	260	± 4.0
80	± 3.0	280	± 4.0
90	± 3.0	300	± 4.0
100	± 3.0	320	± 4.0
110	± 3.0	340	± 4.0
120	± 3.0	360	± 5.0
130	± 3.0	380	± 5.0
140	± 3.0	400	± 5.0
150	± 3.5	450	± 5.0
160	± 3.5	500	± 5.0
170	± 3.5	550	± 5.0
180	± 4.0	600	± 5.0
190	± 4.0	650	± 5.0
200	± 4.0	700	± 5.0

Engineering Specification	
Title: Airspeed, Ground Support Equipment	Barfield, Inc 4101 NW 29 Street Miami Florida 33142
Drawing No: 23-336-00025	Page 4 of 5

6.2 P/N 336-00004:

READING (Knots)	TOLERANCE (Knots)	READING (Knots)	TOLERANCE (Knots)
60	± 3.0	180	± 4.0
70	± 3.0	190	± 4.0
80	± 3.0	200	± 5.0
90	± 3.0	220	± 5.0
100	± 3.0	240	± 5.0
110	± 3.0	260	± 5.0
120	± 3.0	280	± 5.0
130	± 3.0	300	± 5.0
140	± 3.0	320	± 5.0
150	± 3.5	340	± 5.0
160	± 3.5	360	± 5.0
170	± 3.5	400	± 5.0
		420	± 5.0

6.3 P/N 336-00005:

READING (Knots)	TOLERANCE (Knots)
20	± 5.0
30	± 5.0
40	± 3.5
50	± 3.0
60	± 3.0
70	± 3.0
80	± 3.0
90	± 3.0
100	± 3.0
110	± 3.0
120	± 5.0
130	± 5.0
140	± 5.0
150	± 5.0
160	± 5.0
170	± 5.0
180	± 5.0
190	± 5.0
200	± 5.0

Engineering Specification

Title: Airspeed, Ground Support Equipment

Barfield, Inc
4101 NW 29 Street
Miami Florida 33142

Drawing No: 23-336-00025

Page 5 of 5

6.4 P/N 336-00006:

READING (Knots)	TOLERANCE (Knots)	READING (Knots)	TOLERANCE (Knots)
20	± 5.0	140	± 4.0
30	± 5.0	150	± 4.0
40	± 3.5	160	± 4.0
50	± 3.0	170	± 4.0
60	± 3.0	180	± 4.0
70	± 3.0	190	± 4.0
80	± 3.0	200	± 4.0
90	± 3.0	210	± 4.0
100	± 3.0	220	± 4.0
110	± 3.0	230	± 4.0
120	± 3.0	240	± 4.0
130	± 3.0	250	± 4.0





1811D INSTRUCTION MANUAL

SECTION 3. VERTICAL SPEED INDICATOR

The following engineering specification (Document 23-337-00025) details performance requirements of the pressure actuated vertical speed indicators used by Barfield, Inc. to manufacture ground support test equipment.

Engineering Specification	
Title: Vertical Speed Indicator, Ground Support Equipment	Barfield, Inc 4101 NW 29 Street Miami Florida 33142
Drawing No: 23-337-00025	Page 1 of 4

REV.	ECO #	REV. DATE	DESCRIPTION OF CHANGE
A	N/A	Jan/8/1990	Initial Release
B	260-00885	Jan/19/2012	Document reformatted to MS Word.

	Created By	Checked By	Approved By
Name	Guillermo Echarri	Jesus Armas	Jean-Louis Mercier
Signature			
Date	1/19/2012	1/19/2012	1/19/2012

Engineering Specification	
Title: Vertical Speed Indicator, Ground Support Equipment	Barfield, Inc 4101 NW 29 Street Miami Florida 33142
Drawing No: 23-337-00025	Page 2 of 4

1. Purpose:

To specify performance requirements for pressure actuated vertical speed indicators for use in B.I.C. manufactured ground support test equipment.

2. Scope:

This engineering specification covers four (4) basic types of direct indicating instruments as follows:

- TYPE I - Range 0-2000 feet per minute climb and descent.
- TYPE II - Range 0-3000 feet per minute climb and descent.
- TYPE III - Range 0-4000 feet per minute climb and descent.
- TYPE IV - Range 0-6000 feet per minute climb and descent.

3. Identification:

All units regardless of origin of manufacture are to be identified by B.I.C. assigned part numbers as follows:

- TYPE I - to be identified as part number 337-00001.
- TYPE II - to be identified as part number 337-00002.
- TYPE III - to be identified as part number 337-00003.
- TYPE IV - to be identified as part number 337-00004.

4. Test Conditions:

Unless otherwise specified, all tests shall be made with the instrument mounted in the horizontal (Face UP) position.

5. Performance Requirements:

All units are required to meet the following performance requirements before installation in any ground support test equipment.

5.1 Zero Setting Range:

The range of movement of the pointer by means of the zero adjustment shall not be less than 400 feet per minute for the "UP" and "DOWN" position.

5.2 Scale Error:

When subjected to the rates of changes of pressure indicated in Table 1 for the altitude intervals shown, the errors shall not exceed the tolerances specified.

5.3 Lag:

The natural lag of the instrument when timed between the following points shall be between 3 and 15 seconds:

- TYPE I and II - 1800 - 200 feet per minute.
- TYPE III and IV - 2000 - 200 feet per minute.

Engineering Specification

Title: Vertical Speed Indicator, Ground Support Equipment	Barfield, Inc 4101 NW 29 Street Miami Florida 33142
Drawing No: 23-337-00025	Page 3 of 4

5.4 Friction:

A test shall be performed to ascertain friction. In the time intervals at which the lag time is measured, the pointer shall move smoothly towards zero (while no vibration is applied) and shall return to zero within 300 feet

5.5 Leak:

With a vacuum of 15 inches of mercury applied to the static pressure connection, the leakage shall not cause more than 0.05 inches of mercury pressure drop during a 1 minute period. With a pressure of 10 inches of mercury applied to the static connection, the leakage shall not cause more than 0.05 inches of mercury pressure drop during a 1 minute period.

5.6 Position Error:

With atmospheric pressure applied to the instrument, the difference between pointer indication when the instrument is in horizontal (Face UP) operating position and when it is in any other position shall not exceed 50 feet per minute.

6. Qualification Tests:

All instruments shall comply with the requirements of this section.

6.1 Vibration:

The instrument shall be subjected to vibration during testing. While the instrument is being vibrated, the drift of the pointer shall not exceed 50 feet per minute and it shall not oscillate more than 50 feet per minute.

Engineering Specification	
Title: Vertical Speed Indicator, Ground Support Equipment	Barfield, Inc 4101 NW 29 Street Miami Florida 33142
Drawing No: 23-337-00025	Page 4 of 4

TABLE 1

SCALE ERROR TOLERANCE

TYPES I AND II

(Ranges: 0-2,000 and 0-3,000 feet per minute)

Test Rate Ascent and Descent Feet Per Minute	Tolerance Feet Per Minute
500	35
1,000	75
1,500**	150
2,000	250
1,500**	200
2,000	250
1,500**	200
2,000	250

** Maximum test point for Type I.

SCALE ERROR TOLERANCE

TYPES III AND IV

(Ranges: 0-4,000 and 0-6,000 feet per minute)

Test Rate Ascent and Descent Feet Per Minute	Tolerance Feet Per Minute
500	100
1,000	200
2,000	300
3,000**	300
4,000	400
5,000	500
2,000**	300
4,000	400
2,000**	300
4,000	400

** Maximum test point for Type III.