



1811NG

Pitot-Static Test Set

USER INSTRUCTION MANUAL
M/N 1811NG, P/N: 101-01178

Doc. P/N: 56-101-01178
Revision B
March 18, 2015

BARFIELD, INC.

Corporate Headquarters

4101 Northwest 29th Street

Miami, Florida 33142

www.barfieldinc.com

Email: gsesales@barfieldinc.com

Barfield Inc. Confidential and Proprietary Information.

This document and all the information contained herein is the sole property of Barfield Inc.

No intellectual property rights are granted by the delivery of this document or the disclosure of its content.

*This entire document is **proprietary information** and shall **not** be reproduced or disclosed to a third party without the express written consent of Barfield Inc.*

This document and its content shall not be used for any purpose other than that for which it is supplied.

SAFETY

Before using this instrument the operator should read and understand all of the related data. This includes the applicable local safety procedures, this publication, and the instructions for the accessories/options/equipment you are using it with and the system or components under test.

This equipment was designed to be safe when used as per the procedures of this Instruction Manual.

Before you start an operation or procedure in this publication, make sure that you have the necessary skills (if necessary, with qualifications from an approved training establishment).

Follow good engineering practice at all times.

WARNING: A **WARNING** notice indicates a hazard with a potential for property damage, personal injury or death if the instructions are not followed. The operator should not proceed beyond the **WARNING** notice until required conditions are understood and fully complied with.

CAUTION: A **CAUTION** notice indicates a hazard with a potential for damage to the equipment and or loss of data if the instructions are not followed. The operator should not proceed beyond the **CAUTION** notice until required conditions are understood and fully complied with.

WARNINGS

WARNING: The 1811NG is **Not Suitable** for **RVSM** Accuracy requirements

WARNING: When testing with this equipment follow the appropriate procedures as per the AMM or CMM observing all safety instructions.

WARNING: Do not use this equipment for purposes other than as specified in this manual.

WARNING: Do not use this equipment in a wet environment.

WARNING: Do not use this equipment in an atmosphere of explosive gas.

WARNING: This test equipment shall only be serviced by authorized personnel.

CAUTIONS

- CAUTION:** Inspect the aircraft Static Vents for dirt or debris before making any connections.
- CAUTION:** Inspect the aircraft Pitot Probes for dirt or debris before making any connections.
- CAUTION:** Do not connect this equipment to a contaminated aircraft pitot-static system.
- CAUTION:** To prevent damage to this equipment, do not allow water or other contaminants to be introduced into the ports.
- CAUTION:** When equipment is connected with the hoses exercise care not to stand on or in anyway kink the hoses.
- CAUTION:** Always monitor aircraft instruments to insure the maximum rates of change are not exceeded.
- CAUTION:** Failure to follow procedures as written could produce a negative airspeed condition capable of damaging the aircraft instruments.

SYMBOLS ON THE INSTRUMENT

 <p>! WARNING</p> <p>Read and understand operator's manual before using this machine.</p> <p>Failure to follow operating instructions could result in injury or damage to equipment.</p>	<p>Warning – Read and understand operator's manual before using this machine</p>
--	--



ATTENTION

Although every effort has been made to provide the end user of this equipment with the most current and accurate information, it may be necessary to revise this manual in the future. Please be sure to complete and return the enclosed **OWNER WARRANTY REGISTRATION CARD** to Barfield in order to validate the warranty and to ensure that you will receive updated information when published. You **MUST** have your name and address on file at Barfield as a registered user of this equipment, to be able to obtain the service covered by the warranty.

Visit the company website, <http://barfieldinc.com/>, for publication updates.

Please send the Registration Card to:

Barfield, Inc.
P.O. Box 025367
Miami, FL 33102-5367
USA

CONTACT INFORMATION

Users are requested to notify the manufacturer of any discrepancy, omission, or error found in this manual. Inquiries should include specific questions and reference the publication title, number, chapter, page, figure, paragraph, and effective date.

Please send comments to:

**TECHNICAL CUSTOMER SUPPORT - GSTE
BARFIELD, INC.
P.O. BOX 025367
MIAMI, FL 33102-5367
USA**

Telephone **(305) 894-5400
(800) 321-1039**

Fax **(305) 894-5401**

Email gseales@barfieldinc.com

REVISION RECORD

REV.	ECO #	REV. DATE	DESCRIPTION OF CHANGE
A		Jan 20, 2015	Initial Release
B	260-01092	March 18, 2015	Logo Page iii, Table 2, Figure 10, Pages 37 & 42

MAINTENANCE AND REPAIR INFORMATION

The manufacturer of this equipment does not recommend the user to attempt any maintenance or repair. In case of malfunction, contact the manufacturer, to obtain the list of approved repair facilities worldwide, ensuring that this equipment will be serviced using proper procedures and certified instruments.

BARFIELD PRODUCT SUPPORT
DIVISION

Telephone (305) 894-5400
(800) 321-1039

Fax (305) 894-5401

Shipping Address:

Barfield, Inc.
4101 NW 29th Street
Miami, Florida 33142
USA

Mailing Address:

Barfield, Inc.
P.O. Box 025367
Miami, FL 33102-5367
USA

EADS SECA

Telephone 33 (0)1 30 18 53 48

Fax 33(0)1 30 18 53 45

Shipping Address:

EADS SECA
1 Boulevard du 19 Mars 1962 – BP50064
F95503 GONESSE Cedex,
France

TABLE OF CONTENTS

<i>Safety</i> <i>Cautions</i> <i>Attn / Cont</i> <i>Rev / Maint</i> <i>Table of Contents</i> <i>List of Figures and Tables</i>	<u>PAGE</u>
INTRODUCTION.....	1
1. PUBLICATION BREAKDOWN.....	1
2. INFORMATION PROVIDED WITH THE TEST SET.....	1
3. RECERTIFICATION.....	2
CHAPTER 1: GENERAL	4
1. INTENDED USE	4
2. SPECIFICATIONS	4
3. INSTRUCTIONS FOR USE	7
4. TECHNICAL ASSISTANCE	7
CHAPTER 2: RATINGS.....	8
1. SUPPLY VOLTAGES.....	8
2. CONNECTION DESCRIPTION	8
3. ENVIRONMENTAL	8
CHAPTER 3: INSTALLATION.....	9
1. ASSEMBLY.....	9
2. GROUNDING (EARTHING).....	10
3. ELECTRICAL CONNECTIONS	11
4. VENTILATION / DRAINAGE.....	11
5. PNEUMATIC PRESSURE CONNECTIONS.....	12
CHAPTER 4: OPERATION.....	13
1. OPERATING CONTROLS.....	13
2. POSITIONING.....	14
3. ACCESSORIES	14
4. PREPARATION	17
5. POWER ON INITIALIZATION.....	17
6. OPERATING MODES.....	18

TABLE OF CONTENTS (cont'd)

7. TEST SET CONFIGURATION STATUS DISPLAY.....	19
8. USER INTERFACE MENU AND DISPLAY.....	20
9. TEST SET OPERATION.....	34
10. TEST SET LEAK TEST.....	37
11. AIRCRAFT TESTING.....	42
12. ENGINE PRESSURE RATIO (EPR) TEST	51
13. SHUTDOWN PROCEDURE.....	52
CHAPTER 4: RECEIVING, SHIPPING, AND STORAGE	54
1. RECEIVING	54
2. SHIPPING.....	54
3. STORAGE.....	54
CHAPTER 5: MAINTENANCE	55
1. GENERAL.....	55
2. PREVENTATIVE.....	55
3. TROUBLESHOOTING	55
4. CALIBRATION	55
Appendix A: Abbreviations & Glossary	56
Appendix B: Operating Limits.....	58
Appendix C: 1811NG Internal Pneumatic Diagram	61
Appendix D: Menu Navigation.....	62
Appendix E: Tablet App Wi-Fi Connect Procedure	63
Appendix F: Field Firmware Update Procedure	65

LIST OF FIGURES

FIGURE 1 IDENTIFICATION LABEL.....	1
FIGURE 2 OWNER WARRANTY REGISTRATION CARD.....	2
FIGURE 3 LIMITED 2 YEAR WARRANTY.....	3
FIGURE 4 POWER ENTRY MODULE.....	8
FIGURE 5 CASE DIMENSIONS.....	9
FIGURE 6 OPTIONAL TRAVEL / SHIPPING CASE.....	10
FIGURE 7 POWER SUPPLY CABLE.....	11
FIGURE 8 DO NOT OBSTRUCT VENTS.....	11
FIGURE 9 HUMID AIR EXHAUST.....	12
FIGURE 10 1811NG PRESSURE CONNECTIONS.....	12
FIGURE 11 1811NG FRONT PANEL.....	13
FIGURE 12 INSTRUCTION MANUAL, P/N 56-101-01178.....	14
FIGURE 13 ELECTRICAL CABLE, P/N AE9887-ND.....	15
FIGURE 14 HOSE KIT, P/N 115-00633.....	15
FIGURE 15 ANTENNA, P/N 126-00001.....	15
FIGURE 16 CARRYING BAG, P/N 195-00021.....	16
FIGURE 17 AN4 CAPS WITH LANYARD, P/N 176-00001.....	16
FIGURE 18 POWER ON INITIALIZATION DISPLAY.....	17
FIGURE 19 DEFAULT 2-CHANNEL (DUAL PS, PT) MODE.....	19
FIGURE 20 OPTIONAL 1-CHANNEL (PT ONLY) MODE.....	19
FIGURE 21 TEST SET CONFIGURATION INFORMATION DISPLAYED.....	20
FIGURE 22 DISPLAY SETUP AERONAUTICAL MENU.....	21
FIGURE 23 TARGET VALUE KEYPAD SCREEN.....	21
FIGURE 24 DISPLAY SETUP: 4-PARAMETER.....	22
FIGURE 25 DISPLAY SETUP: 2-PARAMETER FORMATS.....	22
FIGURE 26 DISPLAY UNITS – FOR AERONAUTICAL MODE.....	23
FIGURE 27 DISPLAY UNITS – FOR PRESSURE UNITS MODE.....	23
FIGURE 28 LEAK TESTING MENU.....	23
FIGURE 29 LEAK RATE TIMER RESULTS.....	24
FIGURE 30 SELECT ATP LEAK TEST PROFILE.....	25
FIGURE 31 ATP LEAK TEST - PARAMETER PROFILE SCREEN.....	26
FIGURE 32 ATP LEAK TEST RESULTS SCREEN.....	26
FIGURE 33 GO TO GROUND CONFIRM SCREEN.....	27
FIGURE 34 CONCLUSION OF GO TO GROUND.....	27
FIGURE 35 CONCLUSION OF GO TO GROUND.....	28
FIGURE 36 SETUP 1.....	28
FIGURE 37 ALTITUDE CORRECTION SCREEN.....	29
FIGURE 38 ALTITUDE CORRECTION ON-AIRCRAFT.....	29
FIGURE 39 ALTITUDE CORRECTION KEYPAD.....	30
FIGURE 40 TEST SET CONFIGURATION, UPDATED ALTITUDE CORRECTION.....	30
FIGURE 41 SETUP 1 CONTROL MODE(S).....	31
FIGURE 42 SETUP 2 - SELECTING LIMIT FILE TO EDIT.....	31
FIGURE 43 SETUP 2 – EDIT CUSTOM LIMITS.....	32
FIGURE 44 DELETE CUSTOM LIMITS.....	32
FIGURE 45 BACKLIGHT ADJUSTMENT.....	33
FIGURE 46 1811NG FRONT PANEL.....	34
FIGURE 47 INITIALIZATION DISPLAY.....	35
FIGURE 48 LEAK TESTING MENU(S).....	37
FIGURE 49 SELECTING ATP LEAK TEST PROFILE.....	38

LIST OF FIGURES (cont'd)

FIGURE 50 LEAK TEST PROFILE - PARAMETERS SCREEN.....	38
FIGURE 51 LEAK TEST TIMER SCREEN.....	39
FIGURE 52 LEAK RATE TIMER, UNIT SAFE AT GROUND.....	40
FIGURE 53 ATP LEAK TEST.....	40
FIGURE 54 ATP LEAK TEST RESULTS.....	41
FIGURE 55 UNIT SAFE AT GROUND.....	43
FIGURE 56 LEAK TEST RESULTS.....	45
FIGURE 57 CONFIRM GO TO GROUND.....	52
FIGURE 58 UNIT SAFE AT GROUND.....	53
FIGURE 59 WI-FI SETTINGS SCREEN EXAMPLE.....	63
FIGURE 60 TEST SET MENU WHEN TABLET REMOTE IS CONNECTED.....	64

LIST OF TABLES

TABLE 1 PHYSICAL CHARACTERISTICS.....	4
TABLE 2 ENVIRONMENTAL.....	4
TABLE 3 AERONAUTICAL SPECIFICATIONS.....	5
TABLE 4 PRESSURE UNITS SPECIFICATIONS.....	5
TABLE 5 DISPLAY UNITS.....	6
TABLE 6 ENGINE PRESSURE RATIO TEST TABLE.....	52
TABLE 7 AERONAUTICAL LIMITS PROFILE – (DEFAULT).....	58
TABLE 8 AERONAUTICAL LIMITS PROFILE – (MAX).....	58
TABLE 9 AERONAUTICAL LIMITS PROFILE – (DEFAULT).....	59
TABLE 10 AERONAUTICAL LIMITS PROFILE – (MAX).....	59
TABLE 11 EPR LIMITS PROFILE – (DEFAULT).....	60
TABLE 12 EPR LIMITS PROFILE – (MAX).....	60

This page intentionally left blank.

INTRODUCTION

1. PUBLICATION BREAKDOWN

This user instruction manual establishes the standards of operation for the 1811NG Pitot-Static Test Set.

Its purpose is to provide sufficient information for the personnel unfamiliar with this unit to understand it, identify its parts, and operate it in accordance with proper procedures, operating techniques, precautions and limitations.

Note: The manufacturer has designed this equipment to be safe when operated using the procedures and instructions detailed in this manual. Do not use this equipment for any other purpose than that stated, as the protection provided by the equipment may be impaired.

2. INFORMATION PROVIDED WITH THE TEST SET

In addition to this User Instruction Manual, the Test Set is delivered with the four information items described below.

- A. The identification label, example (Figure 1), located on the front bulkhead of the Test Set, provides the following information:

Manufacturer Name	
Designation of Equipment	
Equipment Part Number	
Equipment Model Number	Equipment Serial Number
Equipment Modification (if applicable)	Equipment Options (if applicable)

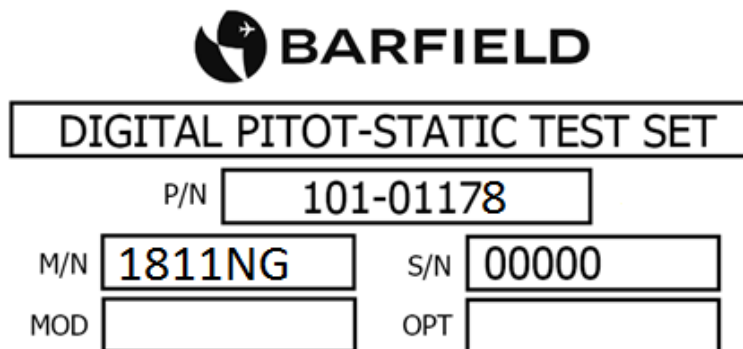

Figure 1 Identification Label

- B. The Owner's Warranty Registration card (Figure 2), is to be completed by the owner and returned to Barfield, Inc. within **ten (10) days** of purchase to ensure automatic update of printed matter and validation of warranty.

OWNER WARRANTY REGISTRATION

RETURNING THIS CARD COMPLETED ENABLES US TO KEEP YOU
AUTOMATICALLY INFORMED OF TECHNICAL UPDATES and VALIDATES YOUR WARRANTY.

NAME _____ TITLE _____

DEPARTMENT _____

COMPANY _____

ADDRESS _____

CITY _____ STATE _____ ZIP _____

P/N _____ S/N _____ MODEL # _____

PURCHASED FROM _____ DATE _____

AIRLINE REPAIR STATION OEM

OTHER _____

INFORMATION GIVEN ON THIS BARFIELD, INC. WARRANTY CARD IS AND WILL REMAIN
STRICTLY CONFIDENTIAL AND WILL NOT BE SHARED. OW-28 REV / 04.00

Figure 2 Owner Warranty Registration Card

- C. Each new or re-certified unit is delivered with a Certificate that shows the date when the unit was tested by the manufacturer, its serial number, and when the next certification is due. This certificate confirms that the unit performed according to its design specifications.
- D. The 1811NG Limited Two Year Warranty can be seen in Figure 3.

3. RECERTIFICATION

- A. The Test Set has a one-year recertification requirement. Maintenance required by this unit must be performed by qualified technicians in a shop equipped with the necessary tooling and facilities. Contact Barfield for Maintenance and Calibration requirements.
- B. At the conclusion of the power up initialization the 1811NG will display the date when it was "Last Calibrated" in the format of Day–Month–Year and will provide the user with the number of days remaining before its calibration due date with a statement of "Cal due" in ### days format.

CAUTION: Recertification by a calibration/repair shop **not** possessing the necessary technical knowledge, documentation, special test equipment, tooling and standards will adversely affect the accuracy/capability of the 1811NG for testing the aircraft.

DPS1000/1811NG LIMITED TWO YEAR WARRANTY

BARFIELD INC. ("BARFIELD") warrants only to the original Purchaser of this DPS1000/1811NG product from BARFIELD or an authorized distributor that this product will be free from defects in material and workmanship under normal use and service for two years after date of purchase. BARFIELD reserves the right, before having any obligation under this limited warranty, to inspect the damaged BARFIELD product, and all costs of shipping the DPS1000/1811NG product to BARFIELD for inspection shall be borne solely by the Purchaser. In order to recover under this limited warranty, Purchaser must make claim to BARFIELD within 60 days of occurrence, and must present acceptable proof of original ownership (such as a purchase order, invoice, warranty card registration, or other documentation BARFIELD deems acceptable) for the DPS1000/1811NG product. BARFIELD, at its option, shall repair or replace the defective unit covered by this warranty. Please retain the dated sales receipt as evidence of the original purchaser's date of purchase. You will need it for any warranty service. In order to keep this limited warranty in effect, the DPS1000/1811NG product must have been handled and used as prescribed in the instructions accompanying this product. This limited warranty does not cover any damage due to accident, misuse, abuse or negligence. This limited warranty is non-transferable and does not apply to any purchaser who bought the DPS1000/1811NG product from a reseller or distributor not authorized by BARFIELD, including but not limited to purchases from internet sites. This warranty does not affect any other legal rights you may have by operation of law. Contact BARFIELD at www.Barfieldinc.com or customer service at (305) 894-5506 for warranty service procedures.

DISCLAIMER OF WARRANTY

EXCEPT FOR THE LIMITED WARRANTY PROVIDED HEREIN, TO THE EXTENT PERMITTED BY LAW, BARFIELD DISCLAIMS ALL WARRANTIES, EXPRESS OR IMPLIED, INCLUDING ALL WARRANTIES OF MERCHANTABILITY AND/OR FITNESS FOR A PARTICULAR PURPOSE. TO THE EXTENT THAT ANY IMPLIED WARRANTIES MAY NONETHELESS EXIST BY OPERATION OF LAW, ANY SUCH WARRANTIES ARE LIMITED TO THE DURATION OF THIS WARRANTY. SOME STATES/PROVINCES DO NOT ALLOW LIMITATIONS ON HOW LONG AN IMPLIED WARRANTY LASTS, SO THE ABOVE LIMITATIONS MAY NOT APPLY TO YOU.

LIMITATION OF LIABILITY

REPAIR OR REPLACEMENT OF THIS PRODUCT, AS PROVIDED HEREIN, IS YOUR EXCLUSIVE REMEDY. BARFIELD SHALL NOT BE LIABLE FOR ANY SPECIAL, INCIDENTAL OR CONSEQUENTIAL DAMAGES, INCLUDING, BUT NOT LIMITED TO, LOST REVENUES, LOST PROFITS, LOSS OF USE OF SOFTWARE, LOSS OR RECOVERY OF DATA, RENTAL OF REPLACEMENT EQUIPMENT, DOWNTIME, DAMAGE TO PROPERTY, AND THIRD-PARTY CLAIMS, ARISING OUT OF ANY THEORY OF RECOVERY, INCLUDING WARRANTY, CONTRACT, STATUTORY OR TORT. NOTWITHSTANDING THE TERM OF ANY LIMITED WARRANTY OR ANY WARRANTY IMPLIED BY LAW, OR IN THE EVENT THAT ANY LIMITED WARRANTY FAILS OF ITS ESSENTIAL PURPOSE, IN NO EVENT WILL BARFIELD'S ENTIRE LIABILITY EXCEED THE PURCHASE PRICE OF THIS PRODUCT. SOME STATES/PROVINCES DO NOT ALLOW THE EXCLUSION OR LIMITATION OF INCIDENTAL OR CONSEQUENTIAL DAMAGES, SO THE ABOVE LIMITATION OR EXCLUSION MAYNOT APPLY TO YOU. THIS WARRANTY GIVES YOU SPECIFIC LEGAL RIGHTS AND YOU MAY ALSO HAVE OTHER RIGHTS THAT VARY FROM STATE TO STATE AND PROVINCE TO PROVINCE.

BARFIELD INC.

4101 NW 29th Street
Miami, Florida 33142, USA

Form 7.5.3-20
Dated 01/07/2015, Rev. 2



Figure 3 Limited 2 Year Warranty

CHAPTER 1: GENERAL

1. INTENDED USE

- A. The BARFIELD INC. **1811NG Imperium Series** (P/N: 101-01178) is a self-contained flight line Pitot-Static Test Set. The 1811NG provides complete measurement and pneumatic control for performing leak testing, functional tests of air data instruments, components and systems.
- B. The 1811NG Digital Pitot Static Test Set meets the requirements as described in Federal Aviation Regulation Part 43 Appendix-E, which defines the requirements for accuracy of an aircraft's altimeter and as such is reference for the accuracy of Pitot-Static testers.

WARNING: The 1811NG is **Not Suitable** for use on aircraft with **RVSM** Accuracy requirements

2. SPECIFICATIONS

A. Physical Characteristics

Size	9.0 in. (22.86 cm), 14.8 in. (37.6 cm), 22.2 in. (56.38 cm)
Weight	35 lbs. (15.9 kg)

Table 1 Physical Characteristics

B. Environmental

Operating Altitude	7,000 ft (2,134 m)
Operating Temp.	0°C to 50°C (32°F to 122°F)
Storage Temp.	-20°C to 60°C (-4°F to 140°F)
Operating Humidity	0 to 90% RH (non-condensing)
Power	100-120/200-240VAC, 50/60Hz, 400VA

Table 2 Environmental

C. Performance

WARNING: The 1811NG is **Not Suitable** for **RVSM** Accuracy requirements

Aeronautical (1811NG)					
	Ps Channel Altitude ALT	Rate of Climb ROC	Pt Channel Calibrated Airspeed CAS	Rate of CAS RtCAS	Mach
Units	Feet	ft/min	knots (kts)	kts/min	-
Operating Range	-1,800 to 55,000	0 to 20,000 0 to 6,000 (*1)	0 to 650	50 to 600 (*2)	0 to 2.8
Accuracy	0.02% FS (*3) ± 7 ft @ 0 ft ± 14 ft @ 20,000 ft ± 20 ft @ 30,000 ft ± 30 ft @ 40,000 ft ± 48 ft @ 50,000 ft	± 2 % of value	0.05% FS (*5) ± 1.0 kts @ 20 kts ± 0.5 kts @ 50 kts ± 0.3 kts @ 100 kts ± 0.2 kts @ 200 kts ± 0.2 kts @ 400 kts ± 0.2 kts @ 650 kts	± 2 % of value	Better than ± 0.005 MACH > 0.1
Repeatability 0.006% FS	± 2 ft @ 0 ft ± 5 ft @ 30,000 ft ± 15 ft @ 50,000 ft	-	± 0.5 kts @ 20 kts ± 0.2 kts @ 50 kts ± 0.1 kts @ 650 kts	-	0.001 rising to 0.005
Resolution	1	1	0.1	1	0.001
Stability (12 month) (*4)	0.025% FS	-	0.025% FS	-	-

Table 3 Aeronautical Specifications

Note (*1): ROC (with 125 cu.in volume)

Note (*2): RtCAS (with 75 cu.in volume) Default is **300 kts/min** operating in Aeronautical mode.

Note (*3): Specification based on typical (0.02% FS) accuracy. Maximum error is 0.04% FS

Note (*4): This tolerance represents the stability over a 12 month period. If tighter tolerances are required, the calibration interval should be reduced or establish proof of stability.

Note (*5): Specification based on typical (0.05% FS) accuracy. Maximum error is 0.1% FS

Pressure Units (1811NG)					
	Ps Channel	Ps Rate of Change ROC	Qc Channel (Note: Pt = Qc + Ps)	RtQc Rate of Qc	EPR
Units	inHg (abs)	inHg/min	inHg (diff)	inHg/min	Ratio: Pt7 / Pt2
Operating Range	2.693 to 38.0	0.1 to 16	0.0 to 40 (*8)	0.5 to 10	0.1 to 10
Measurement	up to 2.693	0.1 to 16	0.0 to 40 (*8)	0.5 to 10	0.1 to 10
Accuracy 0.02% FS (*6)	± 0.0076 inHg	± 2 % of value	± 0.020 inHg	± 2 % of value	0.01
Repeatability	± 0.002 inHg	-	0.001 rising to 0.005	-	-
Resolution	0.0001	-	0.0001	-	1.000
Stability (12 month) (*7)	0.025% FS	-	0.025 % FS	-	-

Table 4 Pressure Units Specifications

- Note (*6): Regarding Ps Channel: Specification based on typical accuracy (0.02% FS). Maximum error is 0.04% FS
 Regarding Qc Channel: Specification based on typical accuracy (0.05% FS). Maximum error is 0.10% FS
- Note (*7): This tolerance represents the stability over a 12 month period. If tighter tolerances are required, the calibration interval should be reduced or establish proof of accuracy/stability.
- Note (*8): $Pt\ max = Ps\ max + Qc\ max = 38.0 + 40.0 = 78\ inHg$
- Note: Accuracy specifications are based on performing the 12 month Recertification cycle and when connected to a leak tight system.

Specifications are subject to change without notice.

D. Display Units

CAS	kts, km/h, mph
ALT	ft , m
MACH	n/a (dimensionless ratio)
ROC	ft/min, m/min
Pt, Ps, Qc	inHg, mbar, psia, psid, kPa, mmHg, inH ₂ O@4°C, inH ₂ O@20°C, inH ₂ O@60°F
EPR	ratio (Pt/Ps), inHg, mbar, psia, psid, kPa, mmHg, inH ₂ O@4°C, inH ₂ O@20°C, inH ₂ O@60°F

Table 5 Display Units

E. Pressure Media

Two internal high reliability electric pumps generate the required pressure and vacuum. The 4-head vacuum pump is configured to provide each channel (Ps & Pt) with its own dedicated 2-headed vacuum source. The pressure pump is a single head unit and supplies both channels (Ps & Pt) with a common pressure supply.

F. Transducers

The Ps channel uses an absolute pressure transducer while the Pt channel uses a differential pressure transducer.

G. Input Power

Electronic switcher power supply module with auto input voltage detection circuitry for an A/C input voltage of 100-120/200-240VAC @ 50-60Hz.

H. Fuse Protection

Fuse overload protection is provided by a Miniature Fuse, 5 x 20 mm, Time-Lag T, L, 250 VAC, 4A is installed on the fuse compartment of the power entry module.

Note: For 200-240 VAC Operation, 5x20 mm, Time-Lag T, L, 250 VAC @ 2A is recommended.

3. INSTRUCTIONS FOR USE

- A. With the Barfield 1811NG Pitot and Static ports connected via the hoses (included) and mating aircraft adapters (not included) to their respective ports on the aircraft, the user is able to enter pressures or equivalent aeronautical values using the test set's touch screen input display to drive the aircraft system to the required points of test.
- B. Optionally the 1811NG test set can be controlled using a Wi-Fi enabled **tablet** (not supplied) as a wireless remote control device. The tester can be used with either an android or iOS **tablet**. Barfield provides a custom App which will be available as a free download from the **Google Play Store** and the **Apple App Store**. The tablet display will exactly mirror that of the tester so that the transition to remote control is seamless. Please refer to **Appendix E** for the **Tablet App Wi-Fi Connect Procedure**.
- C. Please refer to **Chapter 4 OPERATIONS** for complete operating instructions.
- D. Please refer to **Appendix D** for the **Menu Navigation**.

4. TECHNICAL ASSISTANCE

- A. For technical assistance on the Barfield 1811NG please contact Barfield Inc. at:

TECHNICAL CUSTOMER SUPPORT - GSTE
BARFIELD, INC.
P.O. BOX 025367
MIAMI, FL 33102-5367
USA

Telephone (305) 894-5400
 (800) 321-1039

Fax (305) 894-5401

Email gsesales@barfieldinc.com

CHAPTER 2: RATINGS

1. SUPPLY VOLTAGES

- A. The Barfield 1811NG Pitot Static Test Set may be powered from either 100 to 120 VAC @ 50 or 60 Hz, 400 VA, or from 200 to 240 VAC @ 50 or 60 Hz, 400 VA.

2. CONNECTION DESCRIPTION

- A. Power Entry - the power entry module pictured in Figure 4 is a connector Style IEC 320-C14 module with an Illuminated ON/OFF Switch and equipped with an internal fuse holder.

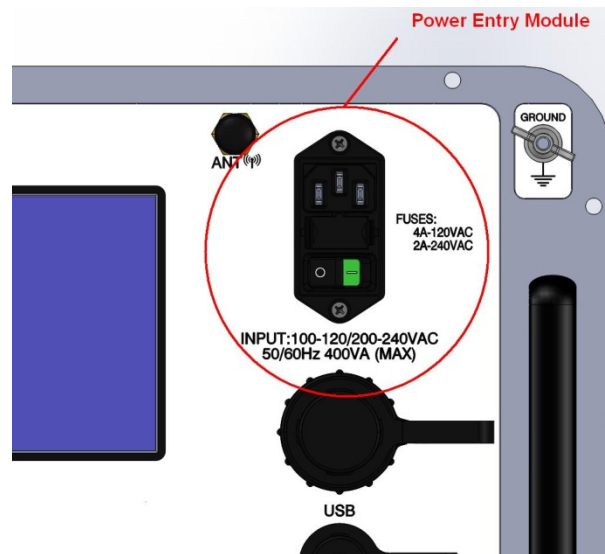

Figure 4 Power Entry Module

- B. The tester must be connected to the correct electrical power supply as stated beneath the power connector.

CAUTION: The supply must provide connection to a protective ground terminal. The unit must always be connected to the supply ground.

3. ENVIRONMENTAL

- A. Altitude: 7,000 ft (2,134 m)
B. Operating Temp: 0°C to 50°C (32°F to 122°F)
C. Storage Temp: -20°C to 60°C (-4°F to 140°F)
D. Operating Humidity: 0 to 90% RH (non-condensing)

CHAPTER 3: INSTALLATION

1. ASSEMBLY

A. Package

Carefully unpack the test set and make a visual inspection of the tester for evidence of damage that might have occurred during shipping. The user should take inventory of the package contents to insure the following items are there:

- (1) 1811NG Pitot Static Test Set
- (2) Hose kit P/N 115-00633 composed of:
 - (a) 1 each Blue 25 ft Hose with AN4 fittings and 1 tethered plug for STATIC (Ps) port connection, P/N 115-00630.
 - (b) 1 each Red 25 ft Hose with AN4 fittings and 1 tethered plug for PITOT (Pt) port connection, P/N 115-00629.
 - (c) Carrying Bag.
- (3) Instruction Manual (this doc)
- (4) Power Cord, 90 degree, 115VAC

B. Enclosure

The test set is encased in a Copolymer injection molded case comprised of upper and lower sections and is depicted in Figure 5:

- (1) The lower section of the case supports the panel assembly.
- (2) The upper section is a removable lid.
- (3) The case is equipped with a One-touch extension handle and wheels for carry-on ease.
- (4) The case is the Largest legal airline carry-on size.
 - (a) Height: 9.0 in. (22.86 cm)
 - (b) Width: 14.8 in. (37.6 cm)
 - (c) Length: 22.2 in. (56.38 cm)
 - (d) Weight: 35 lbs. (15.9 kg)

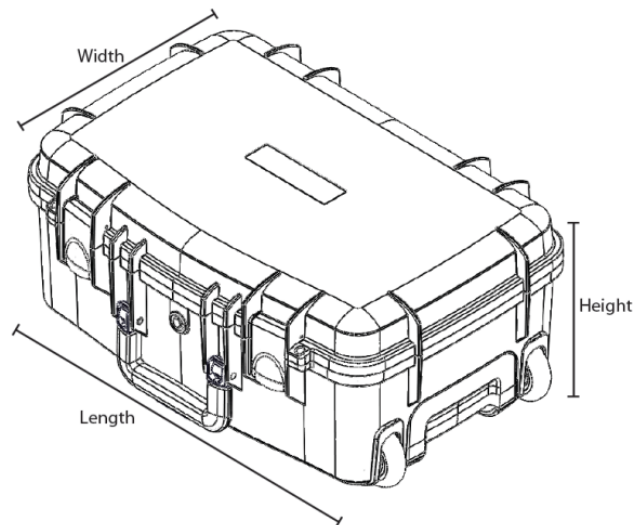

Figure 5 Case Dimensions

C. Container Storage

It is recommended that the factory-shipping container and packing materials be retained should it become necessary, for any reason, to re-ship the Test Set, such as for the O.E.M. recertification.

D. Items not included

- (1) Ruggedized shipping case Barfield P/N 194-00073 see drawing in Figure 6.
- (2) Nav-Aids Pitot Static Adapters – Contact Barfield with your aircraft requirements
- (3) Wi-Fi enabled tablet - either Android or IOS device.
- (4) Wi-Fi Application – available as free download from either Google Play Store or Apple App Store.

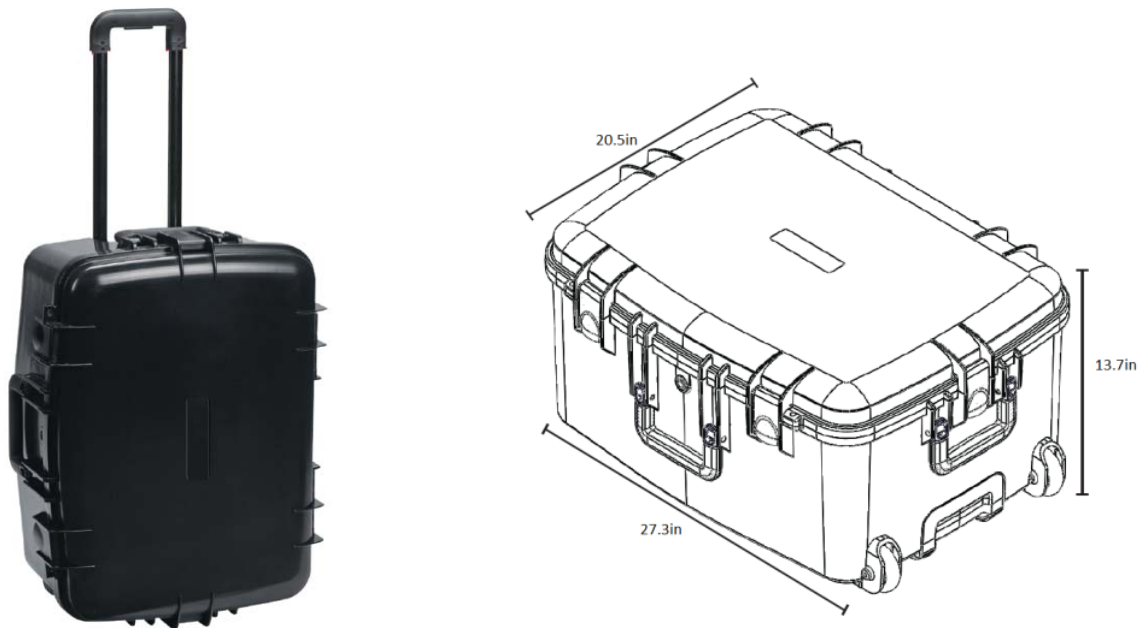

Figure 6 Optional Travel / Shipping Case
(sized to qualify as a checked bag with most commercial airlines)

2. GROUNDING (EARTHING)

- A. The supply must provide connection to a protective ground terminal. The unit must always be connected to the supply ground.
- B. The 1811NG chassis may be grounded to the aircraft or instrument under test using the Ground stud located in the upper right corner of the panel as depicted item 5 in Figure 11.

3. ELECTRICAL CONNECTIONS

The included Power Supply Cable pictured in Figure 7 is a common 3 prong IEC320-C13 AC power cable. The cable length is 6.56' (2.00m) and the wire gauge is 18 AWG.

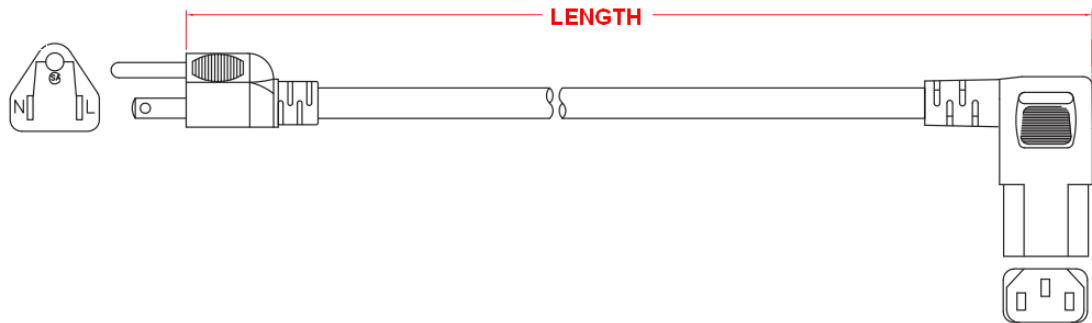

Figure 7 Power Supply Cable

4. VENTILATION / DRAINAGE

A. Ventilation

The 1811NG has exhaust vents on the right side of the unit which must not be blocked. Also there are intake vents on the left side for drawing air through the case which also must be kept free from obstructions. Both sets of vents are labeled as shown in Figure 8



Figure 8 Do Not Obstruct Vents

B. Drainage

The 1811NG has a port located on the front of the enclosure, pictured and labeled as shown in Figure 9 and is used to exhaust humid air which is produced by the internal pressure pump. This port must not be blocked or in anywise restricted.



Figure 9 Humid Air Exhaust

5. PNEUMATIC PRESSURE CONNECTIONS

A. Static and Pitot Ports

- 1- Pt (pitot)- AN4 (MS33656-4)
- 2- Ps (static)- AN4 (MS33656-4)



Figure 10 1811NG PRESSURE CONNECTIONS

B. Blanking Caps

- 1- When not in use the panel mounted Blanking Caps should be fitted to the ports so as to prevent the introduction of any foreign matter.

Note: During the performance of a leak test of the test set, a leak at these AN4 caps will adversely affect the outcome of the test.

CHAPTER 4: OPERATION

1. OPERATING CONTROLS

A. Front Panel Switches and Controls (Components shown in Figure 11).

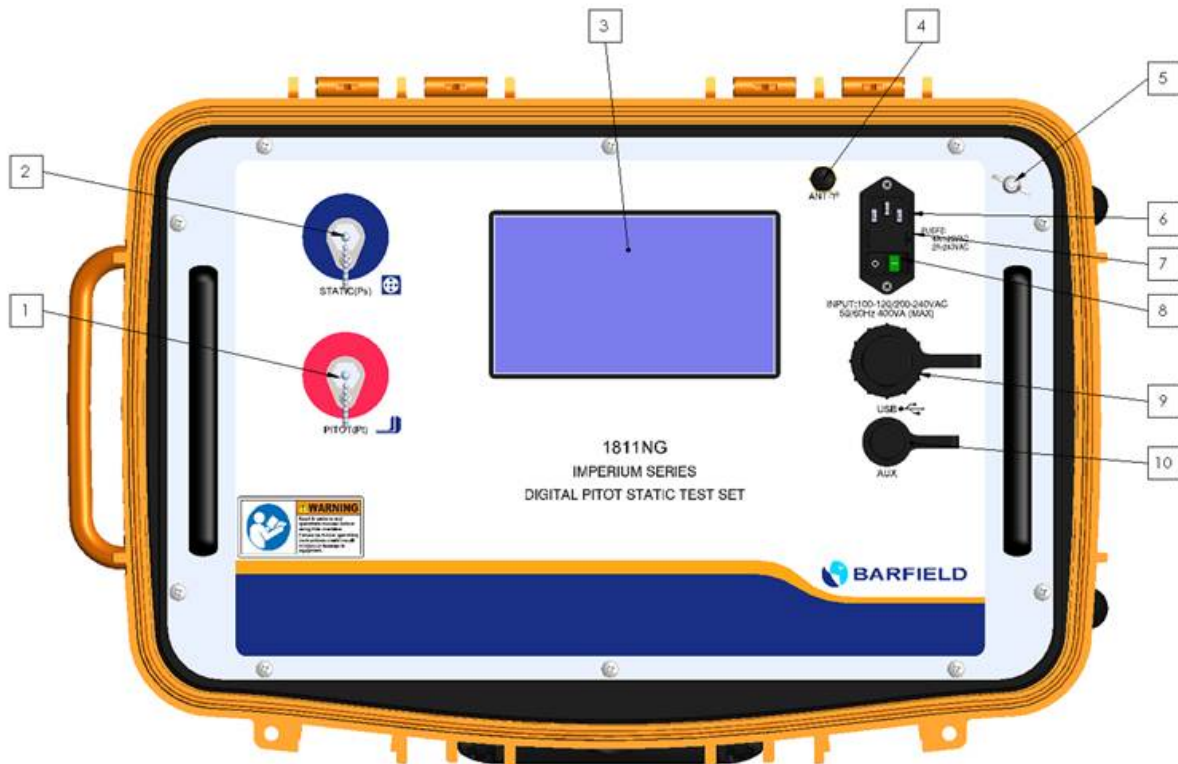

Figure 11 1811NG Front Panel

- | | |
|------------------------------|--|
| (1) PITOT (Pt) PORT | Connect to Aircraft Pitot system. This is also referred to as the Pt port and Total Pressure port. |
| (2) STATIC (Ps) PORT | Connect to Aircraft Static system. This is also referred to as the Ps port. |
| (3) Display - Touch Screen | Touch screen GUI “Graphic User Interface” is used to display and control all aspects of the Test Sets operation. The only physical switch is the Power ON/OFF. |
| (4) Wi-Fi Antenna | Used for Wi-Fi communication. This feature can be used to communicate with either an android or iOS tablet. |
| (5) Ground (Earth) Stud | Used to ensure test set chassis is at same ground potential as Aircraft or Instrument being tested. |
| (6) Fused Power Entry Module | Connects external power to the tester. Unit uses either a cable with a standard 115VAC plug or the optional cable for operator installation of 230VAC plug. |
| (7) Power Entry Fuse holder | Power Entry module fuses. |

- (8) Power ON/OFF switch For 120 VAC operation use 1(ea) fuse: 4A
For 220 VAC operation use 1(ea) fuse: 2A
Used to power On/Off Test Set operation.
- (9) USB port Standard USB Port used for multiple purposes
 - To Upgrade Test Set HUIM or PCM Firmware from flash drive. Please refer to **Appendix F** for the **Field Firmware Update Procedure**.
 - To download Test Set history log contents onto USB flash drive.
- (10) Micro USB port OEM use only

2. POSITIONING

It is important whether testing on the aircraft or on the bench that the test set be positioned so as not to impede the ability to quickly power down and or disconnect electrical power should the need arise.

3. ACCESSORIES

A. Items included

- (1) Instruction manual P/N 56-101-01178, see Figure 12.
- (2) Electrical Cable P/N AE9887-ND, see Figure 13.
- (3) Hose Kit P/N 115-00633, see Figure 14.
- (4) Wi-Fi Antenna P/N 126-00001, see Figure 15.
- (5) Carrying Bag P/N 195-00021, see Figure 16.
- (6) AN4 Caps with Chains P/N 176-00001, see Figure 17.

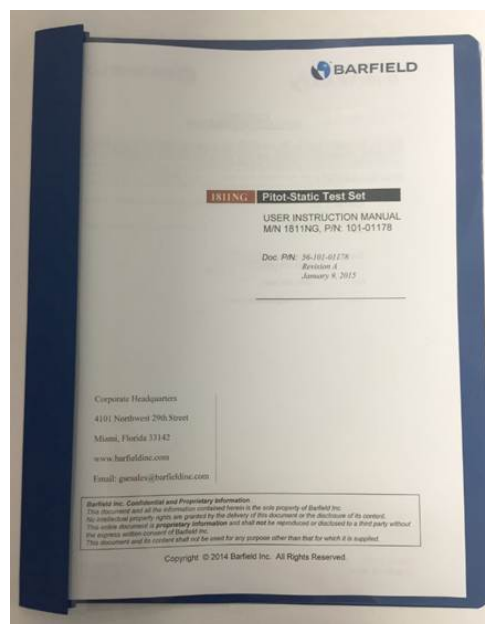

Figure 12 Instruction Manual, P/N 56-101-01178

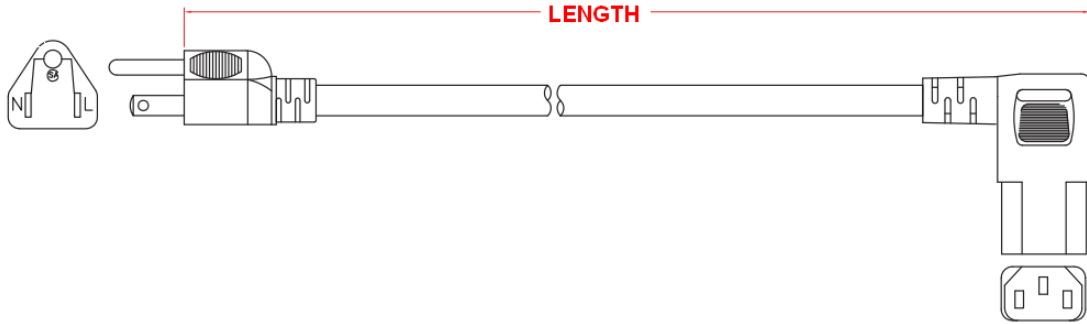

Figure 13 Electrical Cable, P/N AE9887-ND



Figure 14 Hose Kit, P/N 115-00633



Figure 15 Antenna, P/N 126-00001



Figure 16 Carrying Bag, P/N 195-00021



Figure 17 AN4 Caps with Lanyard, P/N 176-00001

B. Items not included

- (1) Ruggedized shipping case Barfield P/N 194-00073 see drawing in Figure 6.
- (2) Nav-Aids Pitot Static Adapters – Contact Barfield with your aircraft requirements
- (3) Wi-Fi enabled tablet - either Android or IOS device.
- (4) Wi-Fi Application – available as free download from either Google Play Store or Apple App Store.

4. PREPARATION

The 1811NG has been designed with a user friendly GUI “Graphical User Interface” which provides an intuitive understanding of the man/machine interaction thereby greatly simplifying the learning experience. However, we still **STRONGLY RECOMMEND** that the user become familiar with the 1811NG operations and menu structure before connecting it to an aircraft system or instruments and/or performing any tests.

The test procedures are described in place of any specifications by either the airframe or instrument manufacturer. Particular attention should be addressed to the preliminary procedures so as to avoid erroneous test results, and to preclude any risk of damage to the aircraft or Test Set instruments. The ports on the test set and mating hoses are color-coded to help prevent accidental crossing of Pitot and Static hoses.

Each test set is completely calibrated and tested before shipment. However to ensure the integrity of the tests, the 1811NG should be **leak checked before each use**. To help automate this process, use the predefined ATP Test Set–only.

WARNING: Observe aircraft and equipment servicing procedures as well as safety precautions detailed in the AMM “Aircraft Maintenance Manual”, CMM “Component Maintenance Manual” and procedures and practices stated in local orders.

5. POWER ON INITIALIZATION

- A. Set power switch to ON. After approximately 7 seconds, the display will indicate “1811NG” during the initial boot-up process. The following, or *similar* screens appear during the Test Set initialization:

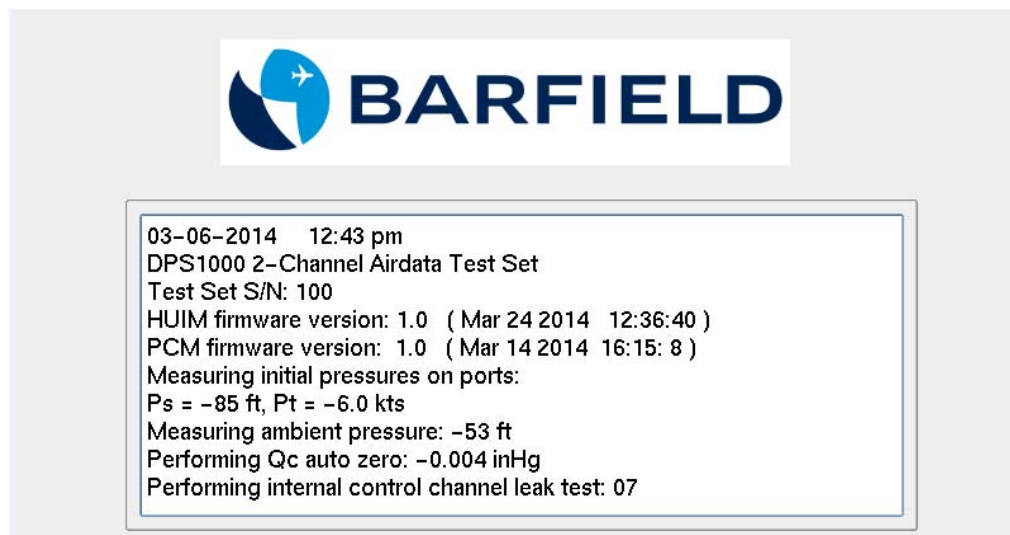

Figure 18 Power On Initialization Display

- B. During the 1811NG power ON initialization process the information is both displayed and written to a log file. The log file provides the ability to go back and view the initialization process and results if needed. The log file can be viewed at a later time by going to the Menu sequence Menu →, Menu →, Log File, Current History.

Note: The “Current History” log file contains logged information for the current powered ON session.

- C. In the final process of the Power ON initialization process, the test set will equalize the internal pneumatic pressures contained within the internal 1811NG manifold and control vessels to ambient. When this process has completed, the test set will then be vented to ambient pressure and the display will indicate this.
- D. At this time the test set is ready for the hoses to be attached to the PITOT (Pt) and STATIC (Ps) ports.
- E. As mentioned earlier, it is standard practice and highly recommended to perform a Test Set Leak Test.

It is preferred that the complete aircraft hook-up configuration be assembled with all hoses and manifolds to result in the most comprehensive leak test of all components prior to attaching adapters to aircraft ports. Install plugs/caps in place of each nav-aids to allow leak testing of the hoses, fittings and manifold if applicable.

At a minimum, perform the leak test with the hoses attached to the test set and with the other end of the hoses capped.

This process will provide the most accurate leak test results and allow the user to establish a baseline regarding what is the leak rate of the Test Set and hose combination prior to interfacing with the aircraft or instrument under test.

6. OPERATING MODES

- A. The 1811NG has two pneumatic control modes of operation, (1) the default mode: 2-channel (Ps & Pt) mode and (2) 1-channel: Pt-Only mode which the user can select under the Setup 1 menu.
- B. The 1811NG when powered ON after the initialization process has completed will always be configured into the default 2-channel (Ps & Pt) mode. The 2-channel mode is by far the most common configuration used while working with aircraft Pitot- Static systems and Aeronautical instruments. In the 2-channel mode, the STATIC (Ps) port is used to both measure and simulate the ALT, pressure altitude equivalent pressures while the PITOT (Pt) port is used to measure and simulate the CAS “calibrated airspeed” equivalent pressures. At all times, the displayed value for pressure altitude “ALT” (ft or m) is computed based on a **Baro** setting of **29.9213** inHg (**1013.25** mb).

Note: The **Baro** setting value cannot be changed.

- C. The Pt-Only mode can be used to drive an Airspeed or MACH indicator that has its STATIC (Ps) port left vented to ambient (local barometric pressure). When the single channel Pt-Only mode is selected the 1811NG will perform a Go To Ground function before transitioning into this mode to ensure the Test Set Ps port is at ambient barometric pressure, and at the conclusion of the Go To Ground function the test set will

leave the STATIC (Ps) port vented to ambient pressure while driving the PITOT (Pt) port to the Target pressures specified by the user.

D. Below are examples of the 2-modes:

(1) Default: Aeronautical 2-Channel (Ps&Pt) (Figure 19)

(2) Aeronautical 1-Channel (Pt Only) (Figure 20)

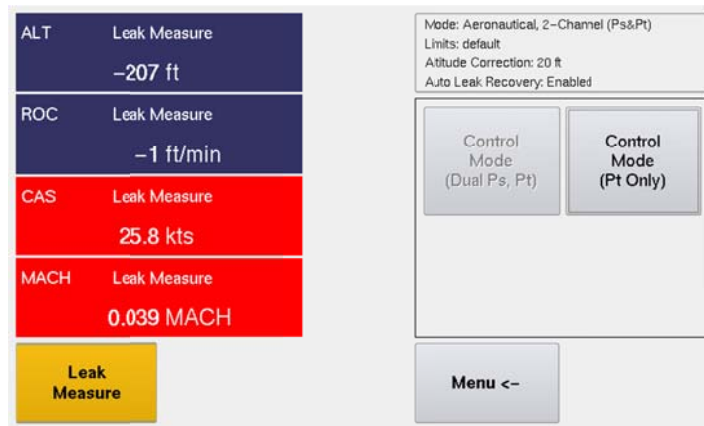

Figure 19 Default 2-Channel (Dual Ps, Pt) mode

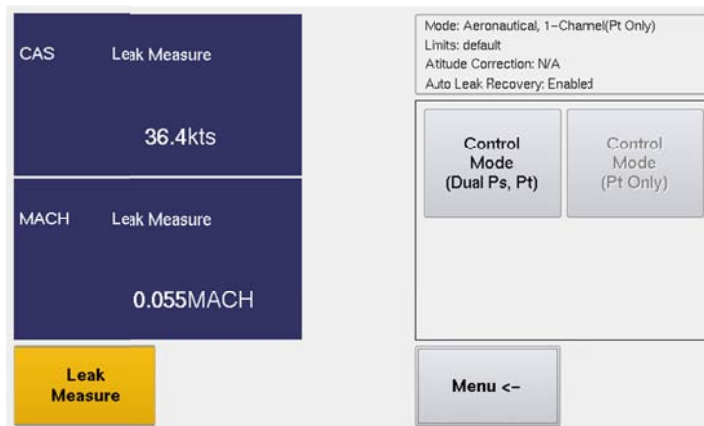

Figure 20 Optional 1-Channel (Pt Only) Mode

Note: Please refer to Appendix D for the complete Menu Navigation

7. TEST SET CONFIGURATION STATUS DISPLAY

The Test Set presents the **Configuration Status** information in the top right quadrant of the display. The following information is included:

- A. **Mode:** 2-channel, Ps & Pt or 1-channel, Pt Only
- B. **Limits:** Indicates the limits profile currently in use
- C. **Altitude Correction:** Indicates the correction factor entered by the user. Default = 0 unless user specifies otherwise
- D. **Auto Leak Recovery:** Enabled or Disabled

Note: The Configuration Status area is an active touch zone that will position the menu page to the 2nd page and is equivalent to selecting Menu >, Setup 1 from the main menu.

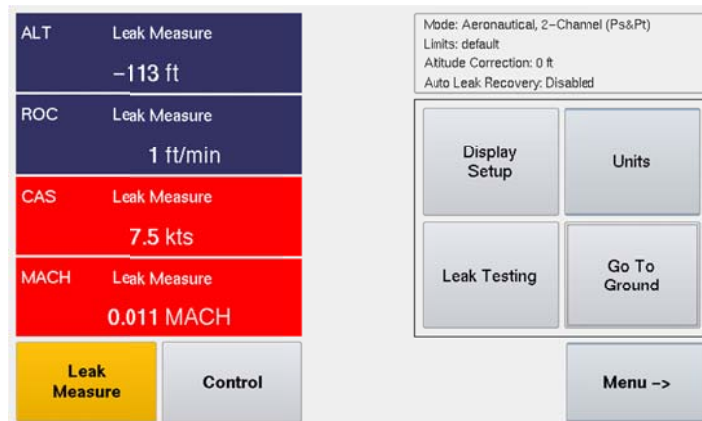

Figure 21 Test Set Configuration Information Displayed

8. USER INTERFACE MENU AND DISPLAY

A. The UI “User Interface” was designed and structured to provide the user/operator with an efficient and intuitive man-machine interface.

- (1) The left-half of the screen is dedicated to provide all the measurement and control display screens.
- (2) The right-half of the screen is dedicated to provide all the menu displays and selections
- (3) The top right-quadrant is used to display Test Set operational status (Mode, Limits, Altitude Correction, Auto Leak Recovery) information.
- (4) The **Leak Measure** and **Control** mode softkey will have an amber background indicating which mode the test set is presently operating in (see Figure 22).
- (5) While in Leak Measure mode, “Target = “ is not displayed for any of the 4-parameters or 2-parameters displayed and therefore the touch zones for those parameters are not active.
- (6) While in Control mode, the 4-parameters or 2-parameters displayed will have a “Target =“ value displayed, when the Test Set transitions from Leak Measure to Control mode the Target value(s) are automatically set to the present value measured on the Ps & Pt ports. During the transition to Control mode, “Wait Resuming Control” is displayed and ALL touch screen zones are disabled except for the “Cancel” soft-key. When the message “Wait Resuming Control” disappears the pneumatic controller has achieved pressure equalization with the current pressure on the Ps & Pt ports. At this time the 4-parameter or 2-paramter touch zones are active and the user can enter Target values for each of the displayed parameters.
- (7) While in Control mode, the Leak Testing softkey is ghosted. Leak testing can only be accomplished while in Leak Measure mode.

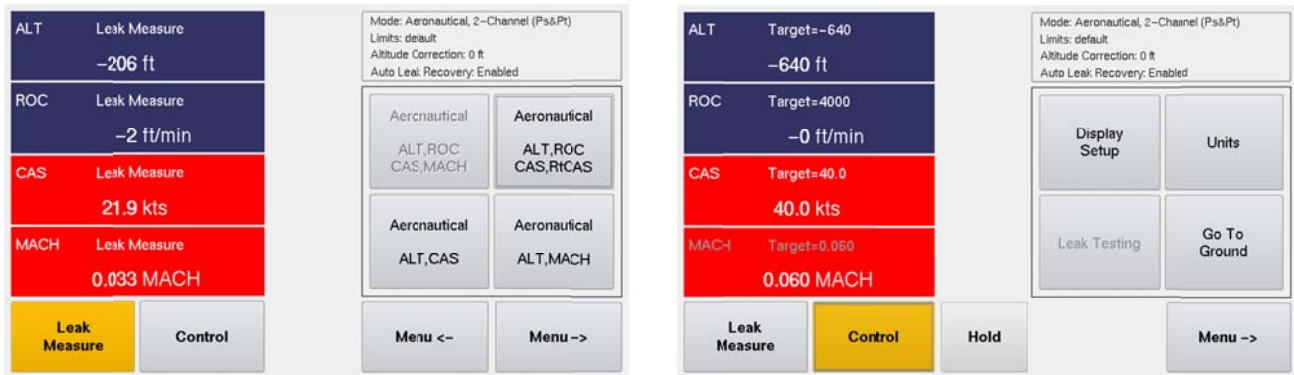

Figure 22 Display Setup Aeronautical Menu

Note: Regarding the UI Menu structure, the menu screen above is considered the top level “Root Menu”.

Note: Throughout this section while explaining all the UI related functions the soft-key “touch screen” sequence will be listed based on starting at the top level “Main Menu” position.

- (8) While in **Control** mode, the Target value(s) can be specified by the user simply touching the pane touch zone area for the Target parameter of interest. For example see below for the Display Setup with ALT, ROC, CAS, MACH being displayed the Target value for any of the 4-parameters can be entered by initially touching the parameter touch zone area which will cause the Target keypad to be displayed for user entry. For this example the ALT touch zone was selected.
- (9) While in **Leak Measure** mode, the touch screen is not active for any of the 4 parameters, only the menu side (right-half) of the screen or the Leak Measure and Control mode softkey are active.



Figure 23 Target Value Keypad Screen

B. Display Setup – Configuring display format

The Display Setup allows the user to configure the display as a 2 or 4-parameter format. While operating in Aeronautical mode for example, the 4-parameter format will allow ALT, ROC, CAS and MACH or ALT, ROC, CAS, and RtCAS to be displayed. While in Control mode, Target values can be assigned to ALL 4 parameters by simply touching the screen on each of the 2 or 4-parameter displayed areas.

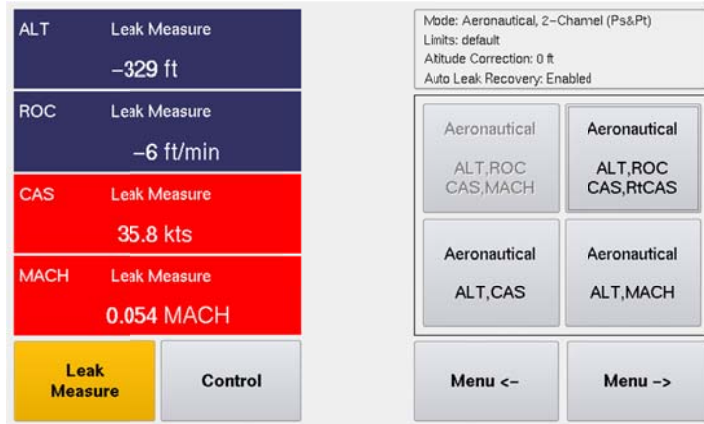

Figure 24 Display Setup: 4-Parameter

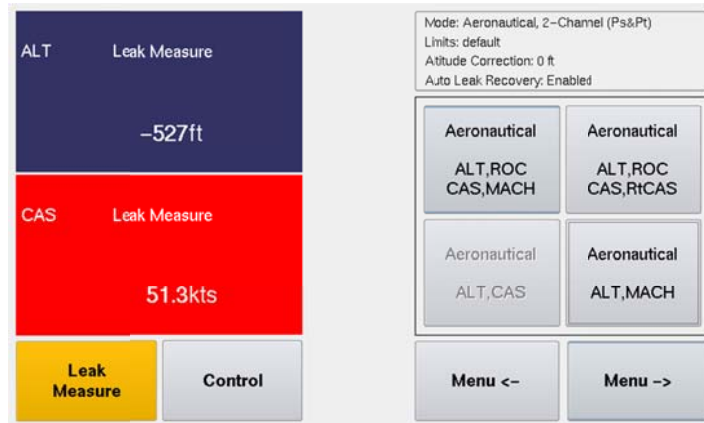

Figure 25 Display Setup: 2-Parameter formats

C. Units - displayed units

Once the Display Setup has been selected, (Aeronautical, Pressure units or EPR, 4-parameter or 2-parameter display format) the Units menu choices allow the user to select the units of measure for the given display parameters selected. For example, for Aeronautical mode the available units for ALT is (1) ft or (2) m, depending on which is selected the corresponding units for ROC (1) ft/min or (2) m/min and for CAS (1) kts or (2) km/h and for RtCAS (1) kts/min or (2) km/h/min. Regarding MACH, it is a dimensionless quantity and is always displayed as MACH.

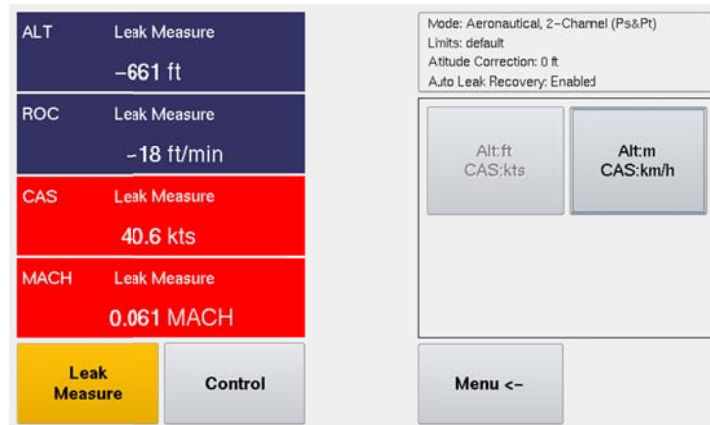

Figure 26 Display Units – for Aeronautical Mode

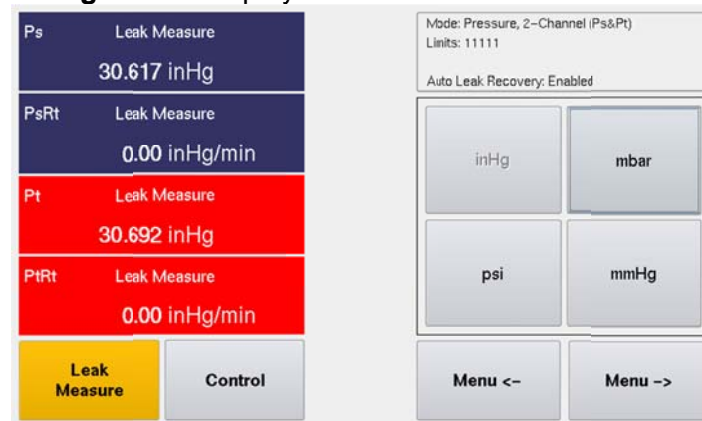

Figure 27 Display Units – for Pressure Units Mode

- D. **Leak Testing** – There are two types of leak tests supported on the 1811NG, the traditional leak testing using the Leak Rate Timer or the Automatic Test Process (ATP) Leak Test Profiles.

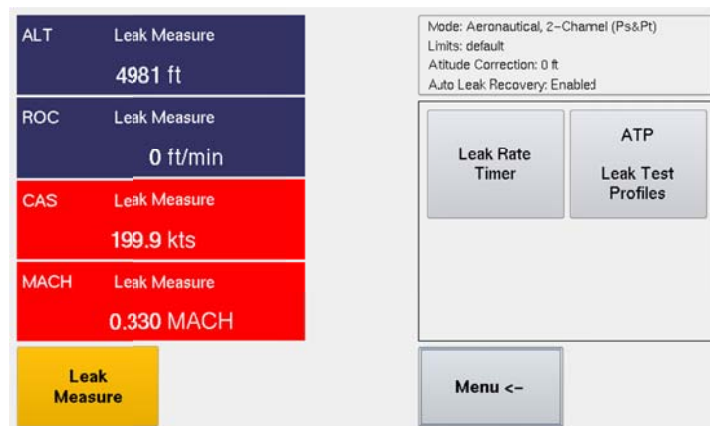

Figure 28 Leak Testing Menu

- (1) **Leak Rate Timer** – traditional leak testing which the user sets the target values of the desired ALT and CAS values. Once the test set achieves those target values the

user selects Leak Measure mode followed by Leak Testing followed by Leak Rate Timer being selected.

Main Menu: Leak Testing → Leak Rate Timer

Wait Time is the duration of time that will allow the Ps & Pt pressure(s) to stabilize before beginning the Leak Test measurement cycle.

Note: Anytime there is compression or expansion of a gas in a closed system there will be a resulting pressure change as a result of adiabatic.

- (a) The Wait Time is to allow thermal equilibrium “adiabatic” to occur so that the leak measurement made during the “Leak Time” phase is truly a result of the system leak rate and not a result of adiabatic instability.
- (b) For Low Level Leak testing < 5,000 ft a Wait Time of 1:00 min is recommended.
- (c) For High Level leak testing (> 10,000 ft or high ROC) a Wait Time of 5:00 minutes or more is recommended to allow for adiabatic stability to occur.
- (d) Leak Time is the duration of time that will be used to measure the leak rate. The value can be changed. Touch “Leak Time” zone area and touch screen keypad will appear allowing User to re-define the Leak Time.

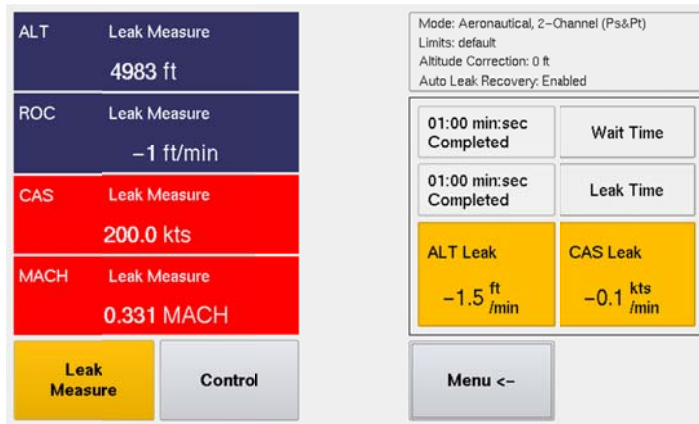

Figure 29 Leak Rate Timer Results

(2) ATP Leak Test Profiles – automated leak testing.

The user can select the ATP “Automatic Test Process” Leak Test Profile which defines the necessary test parameters. Once the ATP profile has been selected, the user can select RUN and walk away returning once completed to observe the leak test results.

Main Menu: Leak Testing, ATP Leak Test Profiles, Select Leak Test Profile(s)

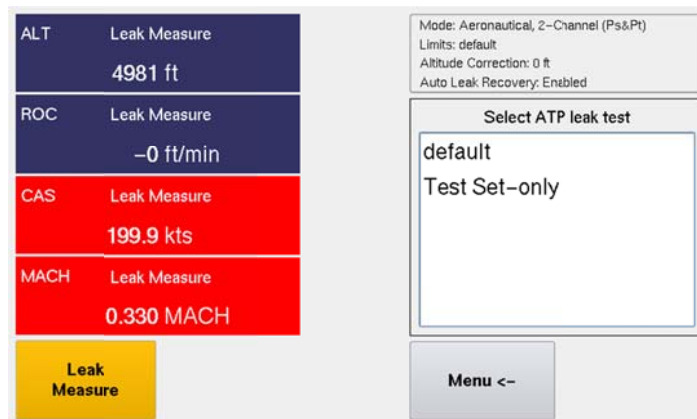

Figure 30 Select ATP Leak Test Profile

The ATP Leak Test provides the following profile options:

- (a) **ALR** “Auto Leak Recover” can be “(X)” selected/deselected
- (b) **Ambient Comp** can be “(X)” select/deselected

Ambient Comp, compensates for local ambient barometric pressure to ensure for example that a 5,000 ft leak test is really checked at a pressure altitude equivalent to 5,000 ft above the local barometric pressure.

- (c) **Pass Limits** can be “(X)” selected /deselected which determines whether or not pass/fail limits are used. If Pass Limits is selected “(X)”, the user can specify the pass limit value for each of the 3 possible leak tests.

Regarding the actual Leak Test(s), there are 3 possible leak tests that can be selected. (1) Pt channel, (2) Ps Low ALT and (3) Ps High ALT.

Note: For the Pt channel leak, the ATP will automatically take the Ps channel to ground prior to starting the Pt channel leak test.

- (d) **Wait**: The wait time is the time allowed for the system under test to settle and stabilize after the target CAS or ALT has been reached. The general rule is the higher the target CAS or ALT a longer wait time should be used to allow for adiabatic to settle so that the leak measurement will truly represent the systems leak rate and not be influenced by the expansion/contraction of gases in a closed system. The Pt and Ps Low ALT share the same Wait time value while the Ps High ALT has its own wait time value specified.
- (e) **Measure**: The measure time is simply the amount of time to allow for the leak measurement cycle. Typically 1:00 minute is used for Pt & Ps Low ALT and a longer time may be used for Ps High ALT.
- (f) **Run**: begins executing the ATP leak test that is presently loaded as defined.
- (g) **Save**: simply saves the present ATP leak test parameters as presently defined.
- (h) **Cancel**: exits the ATP leak test. Any changes made to the ATP leak test parameters will not be saved.

ATP Leak Test:

ALR Ambient Comp Pass Limits

Pt

200.0 kts Pass Limit 0.3 kts

Ps Low ALT ROC 3000 ft/min

5000 ft Pass Limit 25 ft

Wait 01:00 min:sec Measure 01:00 min:sec

Ps High ALT ROC 6000 ft/min

20000 ft Pass Limit 50 ft

Wait 01:00 min:sec Measure 05:00 min:sec

Run Cancel Save

Figure 31 ATP Leak Test - Parameter Profile Screen

ALT	Target=-185	ATP Leak Test: Test Set-only				
	19928 ft	Wait Time (min)	Measure Time (min)	Leak Rate (/min)	Status	
ROC	Target=6000	Pt	00:30	01:00	0.1kts	Pass
	-6 ft/min	Ambient Comp: Disabled				
CAS	Target=0.0	Ps Low Alt	00:30	01:00	-4.3ft	Pass
	200.2 kts	Ps High Alt	05:00	01:00	-6.7ft	Pass
RtCAS	Target=59.7					
	0 kts/min					
Leak Measure		Wait Resuming Control			Cancel	

Figure 32 ATP Leak Test Results Screen

- E. **Go To Ground:** This function will take the Test Set back to Ground (ambient barometric pressure altitude) and CAS = 0 Kts. Go To Ground can be selected while operating in Leak Measure or Control mode.

Note: During Power ON initializations, the Test Set measures ambient barometric pressure "GROUND" and stores it in a temporary memory. When the user selects Go To Ground, the Ps Target = ambient pressure altitude. After completion of Go To Ground (Unit Safe at Ground) the Test Set measures ambient barometric pressure again and that becomes the latest ambient barometric pressure altitude at ground.

Main Menu: Go To Ground

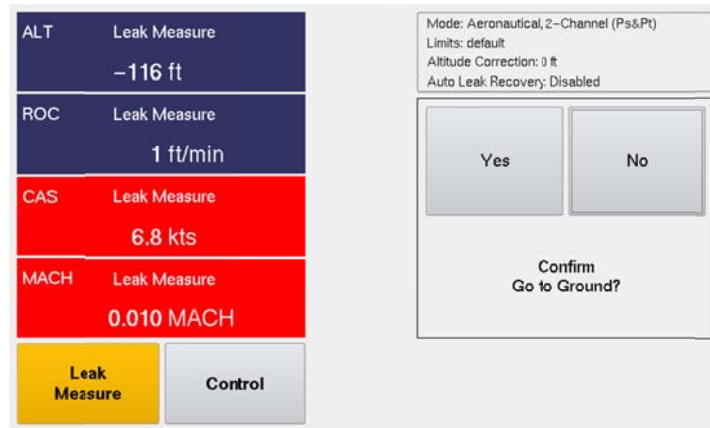

Figure 33 Go to Ground Confirm Screen

The user can select “Go To Ground” from the Main menu, while in either Leak Measure or Control mode. At the conclusion of Go To Ground, the Test Set will perform an AutoZero function to trim off any small Qc pressure offset that may have crept into the Qc transducer typically due to thermal component (Test Set Warming or cooling). The AutoZero function greatly improves the low airspeed (< 50 kts) measurement accuracy. Also, the Test Set will remain vented to ambient until the Control mode is selected.

Note: There are two circumstances where an AutoZero function is performed (1) at the conclusion of Go To Ground function and (2) every 5 minutes if CAS < 50 kts and the Test Set is in the Leak Measure mode.

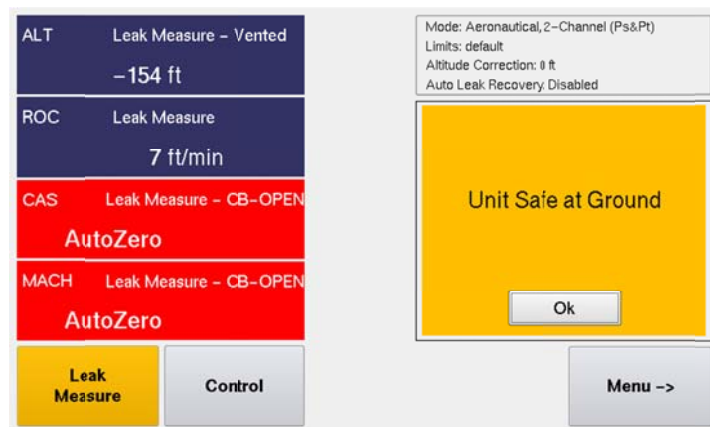

Figure 34 Conclusion of Go To Ground

When the AutoZero function is performed, the CB valve (Sv_CB) is OPEN.

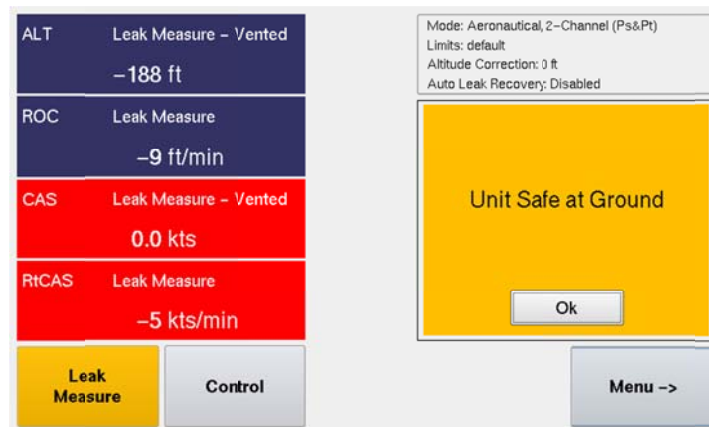

Figure 35 Conclusion of Go To Ground

After a Go To Ground function is performed, Test Set will remain vented to ambient.

F. **Setup 1** – The following is available under this set of menu(s):

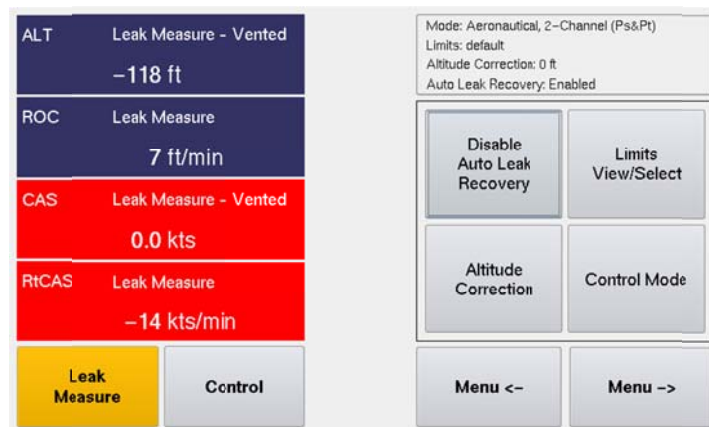

Figure 36 Setup 1

Main Menu: MENU →, Setup 1

- (1) Auto Leak Recovery – When the Test Set is operating in Leak Measure mode and Auto Leak Recovery is Enabled. If a high leak rate occurs (High ROC or RtCAS) then ALR will automatically activate CONTROL mode which will then set ALT target and CAS target to present level and the controller will come online and try to maintain the current Altitude & CAS. To disable this feature, select Disable Auto Leak Recovery.
- (2) Limits View / Select – Allows user to select and view any of the saved limit file values.
- (3) Altitude Correction – Allows user to enter a correction factor regarding the altitude difference between the physical test set and the Aircraft ports and or Unit under test. Below is an example of the Aircraft static port being located 20 ft physical higher (“+”) than where the 1811NG test set is located.

Note: If the 1811NG test set was physically higher than the instrument or aircraft then the altitude correction would be entered as a (“-”) negative value.

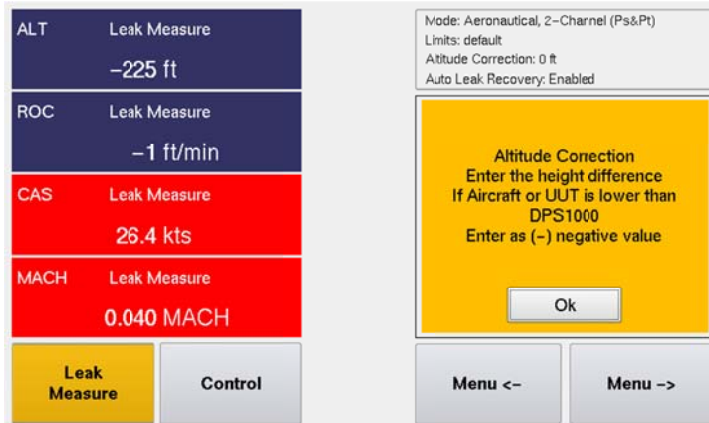

Figure 37 Altitude Correction Screen

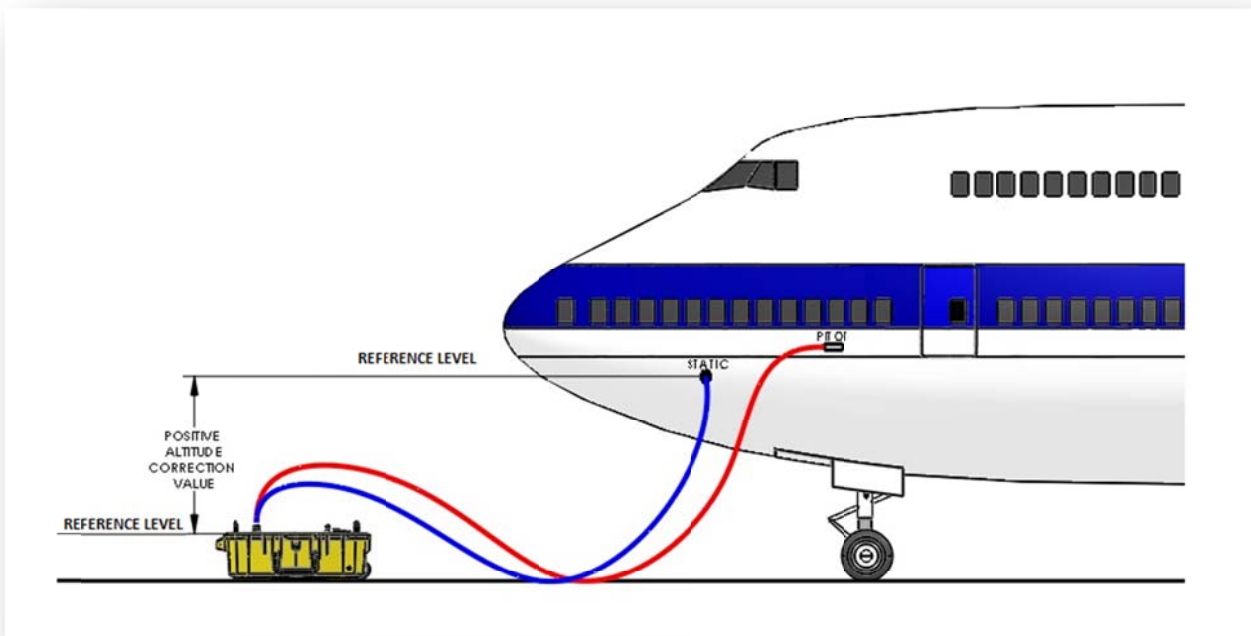

Figure 38 Altitude Correction On-Aircraft



Figure 39 Altitude Correction Keypad

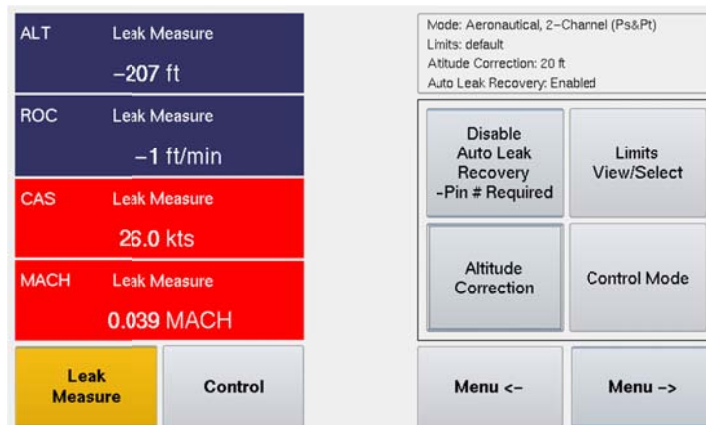

Figure 40 Test Set Configuration, Updated Altitude Correction

- (4) Control Mode – Allows user to select the default: 2-Channel (Ps & Pt) mode or 1-Channel (Pt-Only) mode. You will see the operating “Mode:” is always indicated in the status window located on the top right-side of the UI display.
- (5) The Pt-Only mode can be used to drive an Airspeed or MACH indicator that has it’s Ps (static) port vented to ambient (*local barometric pressure*). When the single channel Pt-only mode is selected the 1811NG will perform a Go To Ground function before transitioning into this mode to ensure the Test Set Ps port is at ambient barometric pressure, at the conclusion of the Go To Ground the test set will leave the Ps port vented to ambient while driving the Pt port to the Target pressure specified by the user.

Note: The 1811NG always powers up into the default: 2-Channel (Ps & Pt) mode.

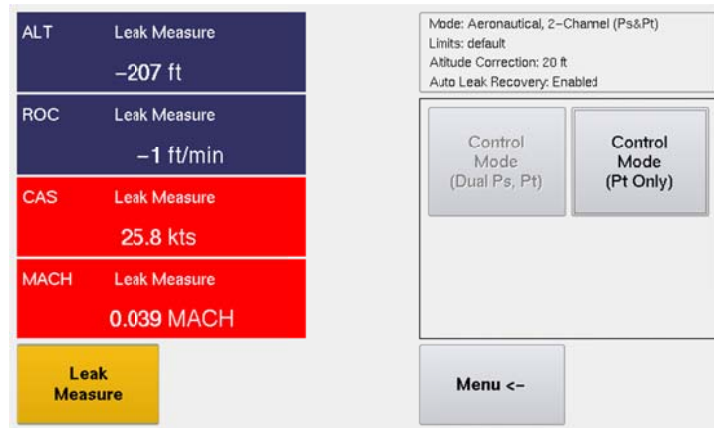

Figure 41 Setup 1 Control Mode(s)

(6) Copy History file to USB

This allows a copy of the history log to be transferred to an external USB flash drive. With the file on a flash drive it can be opened and reviewed using any tool that allows viewing of ascii text files. At times this file could be emailed to Barfield to aide in trouble shooting some issues/problems. In case of required technical support, Barfield personnel may request that this file be forwarded to them for troubleshooting purposes.

G. Setup 2 – (PIN Required)

The Setup 2 menu is **PIN** protected to provide some level of security to the activities that can be accomplished under this menu structure. After entering the user **PIN** code (default code is **123456**), the following screen (Fig 42) will allow:

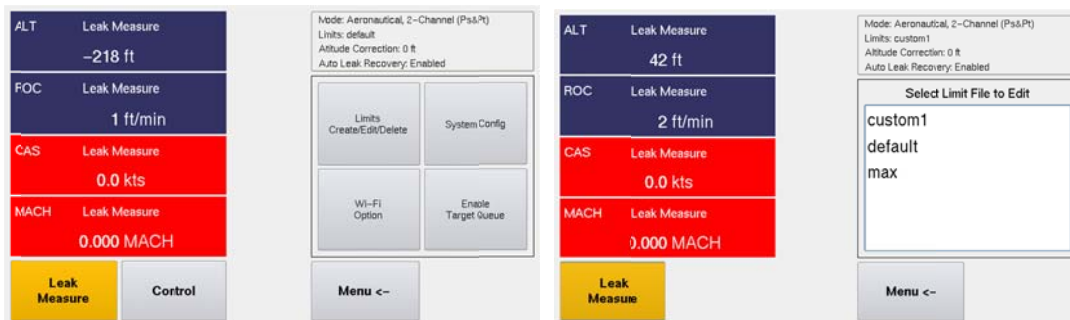

Figure 42 Setup 2 - Selecting Limit File to Edit

(1) **Limits** – Create, Edit, Delete

(a) Create Custom Limits

Allows user to create custom limit profile(s).

Note: This is in addition to the two pre-defined (1) default and (2) max limit profiles.

(b) Edit Custom Limits

Allows user to edit custom limit profile(s).

Note: The user cannot edit the two pre-defined (1) default and (2) max limit profiles.



Figure 43 Setup 2 – Edit Custom Limits

(c) Delete Custom Limits

Allows user to delete custom limit profile(s)

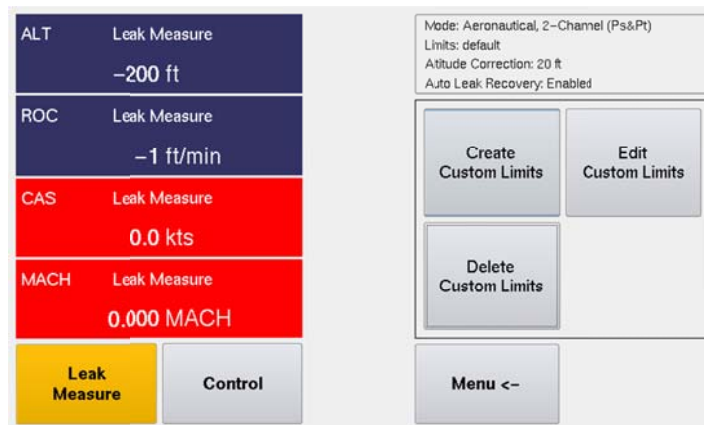

Figure 44 Delete Custom Limits

- (2) **System Config** (*future feature, presently not supported*)
- (3) **Wi-Fi Option**
- (4) **Enable Target Queue** (*future feature, presently not supported*)
- (5) **Flash – HUIM from USB** (Update HUIM firmware from dpsx file located on USB flash drive)
- (6) **Flash – PCM from USB** (Update PCM firmware from controller.hex file located on USB flash drive)
- (7) **Set Date & Time**

H. **Setup 3** – This is for OEM only, OEM or Service PIN required.
(Custom PIN required for each Test Set)

I. **Change User PIN**

Allows user to change the current user PIN

Note: User must know the current PIN in order to change it

J. **Help** – brief top level help screens

K. **Touchscreen Calibration**

If touch screen sensitivity or zone accuracy has shifted, allow user to calibrate touch screen

L. **Log File** - There are two log file selections available

a. Current History – Recorded event history since the unit was last powered on

b. Complete History – Recorded ALL event history dating back to either when the product was 1st powered ON or until it was last cleared

Note: Only OEM under Setup 3 can clear the Complete History file

M. **Backlight** – Adjust display backlight intensity

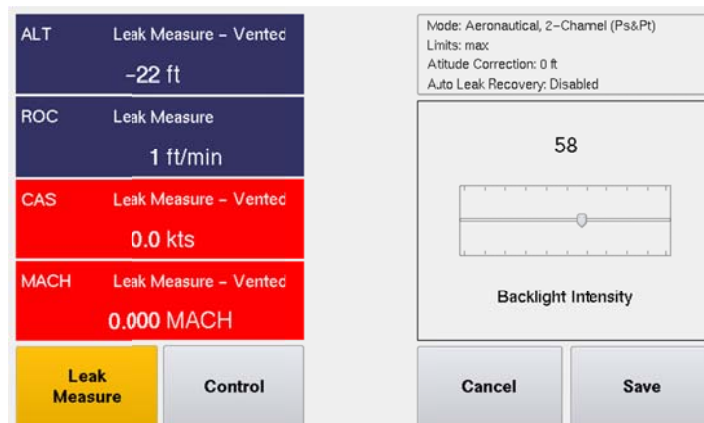

Figure 45 Backlight Adjustment

9. TEST SET OPERATION

A. Preliminary Setup

- (1) Ensure that the 1811NG Powered ON/OFF switch (8) is in the OFF position prior to connecting the AC power cable.
- (2) As a standard practice and under normal circumstances it is recommended that the 1811NG does not have hoses connected prior to initialization. This is not a requirement just an additional precaution.



Figure 46 1811NG Front Panel

B. Power ON

During normal use, it is recommended that the Test Set is powered ON and allowed to complete its Power ON initialization process prior to connecting the hoses to the STATIC (Ps) and PITOT (Pt) ports. During power ON initialization the following discovery occurs:

- (1) The Test displays a power ON initialization window during this phase as shown above. There is a log file created that records all the initialization steps and results that occur during this phase.
- (2) The test set measures the initial pressure found on STATIC (Ps) and PITOT (Pt) ports and records it as a temporary value.
- (3) The ambient pressure is measured and recorded as a temporary value. This value will be used by the Go To Ground function.

- (4) The Pt measurement channel performs a Qc auto-zero to trim any small offset that has occurred.
- (5) An internal control channel leak test is performed. The control channel leak test should not be confused with the actual leak test of the Test Set itself. The control channels are very small pneumatic channels within the manifold between the proportional control valves and the transducers. During this test the test sets internal manifold mounted output valves SvPs_Out and SvPt_Out are closed and therefore the Ps and Pt Output reservoirs are not included in this test.
- (6) The Vacuum Pump and pressure pumps are tested to verify they are able to achieve the performance expected.
- (7) The initialization display window and log file includes the Test Set(s) power on cycle count, # of hours the test set has been powered ON, # of hours on the pressure pump, # of hours on the vacuum pump.
- (8) At the end of the initialization cycle the test set performs a Go to Ground to ensure both the STATIC (Ps) and PITOT (Pt) ports are at ambient pressure.

Note: During this power ON initialization Go To Ground phase the Target ROC will default to a very low rate (2,000 ft/min), the user can change the ROC for that occurrence but touching the ROC touch zone and changing the Target value.

Note: After power ON initialization has completed, the test set will remain in Leak Measure mode with the STATIC (Ps) and PITOT (Pt) ports Vented to ambient and the displayed message will be:

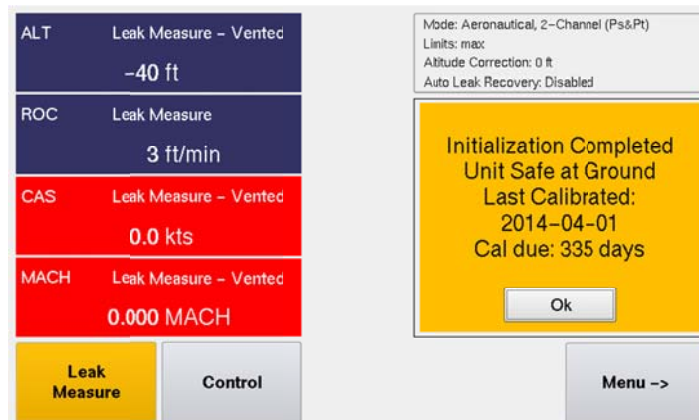

Figure 47 Initialization Display

C. Leak Measure Mode

The 1811NG has two modes of operation, **Leak Measure** and **Control**. The default mode of operation for the 1811NG is Leak Measure mode. At the conclusion of power ON initialization the Test Set will be placed in the Leak Measure mode.

While in Leak Measure mode the Test Set is continuously measuring / monitoring the pressure on both the STATIC (Ps) and PITOT (Pt) ports. The display will be continuously updated (~ 2 times/second) with the latest pressure measurement results. In Leak Measure mode, the pneumatic pressure pump, vacuum pump and four proportional control valves (PvPs_V, PvPs_P, PvPt_V, PvPt_P, reference 1811NG Pneumatic diagram) are off.

When the **Display Setup** is configured for **Aeronautical** mode, the 1811NG has some additional features and safe guards such as **ALR** and **Leak Test ATP**.

While in Leak Measure mode, the ALR “Auto Leak Recover” (if enabled) monitors the leak rate of ROC and RtCAS. If the rates exceed the values defined under the Limits menu (Example: with Limits=default, ALR for ROC = 1,000 ft/min and RtCAS=25 kts/min) the Test Set will automatically switch into Control mode with the Target values set to the current ALT and CAS values and the Test Set pneumatic controller will try to overcome the leak and stabilize the pressures on the STATIC (Ps) and PITOT (Pt) ports. When this occurs, there will be a message displayed “Excessive Leak Detected”.

The Leak Test ATP profiles are only available when the Display Setup is configured for Aeronautical display mode. When the user selects Pressure or EPR “Engine Pressure Ratio” display mode, the Leak Test ATP will not be available only the Leak Rate Timer feature is available under these two display modes.

D. **Control Mode**

The Control mode on the 1811NG provides a two channel pneumatic controller. The 1811NG controller is referred to as the PCM “Pneumatic Control Module, this module provides an absolute pressure controller for the STATIC (Ps) channel and a differential pressure controller for the PITOT (Pt) channel. This two channel precision controller is used to control and simulate the Target pressure and vacuum set point conditions and rates as requested by the user setting Target set points. The pneumatic controller is capable of controlling the STATIC (Ps) channel pressure with a resolution of ~ 0.0002 inHg while maintaining/controlling the PITOT (Pt) channel differential pressure with a pressure resolution of ~0.0004 inHg. The precision custom controller provides the ability of maintain a constant CAS “Airspeed” (maintaining a constant differential pressure with regards to the STATIC (Ps)) even during high rates of ROC enabling 0 kts CAS (the most demanding control situation) to be well maintained under considerably high slew rates of 6,000 ft/min and higher.

When the 1811NG transitions into **Control** mode, the display indicates “**Wait Resuming Control**” during this transition period (~ 4 seconds) the PCM is responsible for establishing the same controlled pressures as last measured on the STATIC (Ps) and PITOT (Pt) ports while in Leak Measure mode. During the Leak Measure to Control transition, the Target set points are always preloaded with the same value as the existing pressure measured on the ports at the time the Control mode was selected.

The following internal control sequences occur:

- (1) The pressure presently on the STATIC (Ps) and PITOT (Pt) ports are measured and recorded.
- (2) The output valves located internally on the 1811NG pneumatic control manifold (SvPs_Out and SvPt_Out) are closed to isolate the pneumatic controller from the aircraft or instrument under test. This is done to insure that no transient pressure spikes are seen or impressed onto the UUT or aircraft while the internal control manifold is establishing the same control pressures that was last measured on the STATIC (Ps) and PITOT (Pt) ports, during this process the test set displays “Wait Resuming Control”. Once the PCM has established stable internal control vessel pressures the output valves (SvPs_Out and SvPt_Out) are opened.

10. TEST SET LEAK TEST

Each Test Set is completely calibrated and tested before shipment, but to ensure the integrity of the sensitive tests to be made, the pretests included in this section should be performed immediately before each use of the 1811NG.

C. PRELIMINARY SETUP

- (1) Ensure hoses are connected to the PITOT (Pt) port and STATIC (Ps) port of the test set. If the connectors on the aircraft end of the hoses are not quick disconnects or self-sealing, then a tight sealing plug should be used to seal the hose assembly. This is necessary to test the hose leakage as well as the tester. If a sealing plug is not available, then leak test the 1811NG without connecting the hoses.
- (2) Connect the test set power cord, the STATIC (blue) hose and PITOT (red) hose to the test set if not already connected.

Note: The ports on the test set and mating hoses are color-coded to help prevent the accidental crossing of Pitot and Static hoses.

- (3) Set the POWER switch to ON. Allow the initialization to complete, then select "Leak Testing".

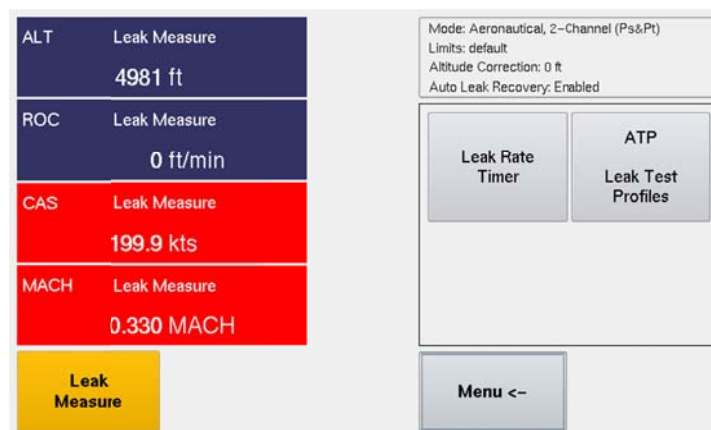

Figure 48 Leak Testing Menu(s)

- (4) There are **two methods** available for performing **Leak Testing** using the 1811NG:
 - (a) Method-(1) **Leak Rate Timer**: the traditional method uses the Leak Rate Timer where the user first establishes a given CAS and ALT and uses the Leak Rate Timer to measure the Leak Rate.
 - (b) Method-(2) **ATP Leak Test**: the 1811NG has an automated feature called ATP Leak Test which allows the user to setup a profile ahead of time with the following parameters: (see Figure 49 and Figure 50) This is much more efficient since the user can select or create the profile and select RUN to execute the automated leak test and return when the ATP Leak Test has completed to review the leak test results.

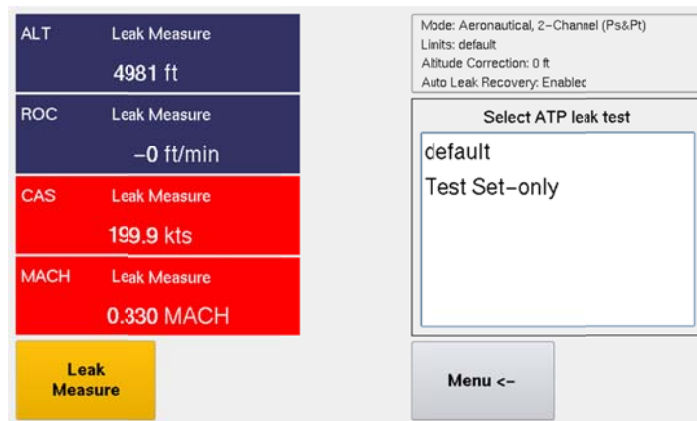

Figure 49 Selecting ATP Leak Test Profile

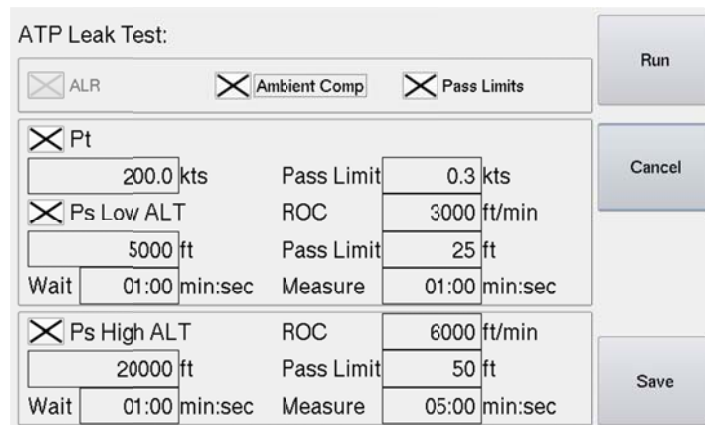

Figure 50 Leak Test Profile - Parameters Screen

- (5) Select from the UI Menu: (1) Leak Testing, (2) ATP Leak Test Profiles, (3) Test Set-only
- (6) The ATP Leak Test Profile for Test Set-only will perform a combined Pitot and Static Leak Test in the following order:
 - (a) (1st) Pitot (Pt channel) Leak Test (default= 200 kts) while Ps channel remains at ground “ambient” pressure. If the (Ps channel) is not presently at ground, the ATP will automatically perform a Go To Ground function before starting the Pt channel leak test.
 - (b) (2nd) Static (Ps channel) low level (default=5,000 ft)
 - (c) (3rd) Static (Ps channel) high ALT (default=20,000 ft)

Note: The ATP Leak Test Profile “Test Set-only” can be altered by the user, once it has been altered it can be saved but a different profile name will be required.

Note: “Test Set-only” implies that no aircraft or instrument(s) are connected. Ideally the test set has the hoses attached and capped off so the test result represents the base line leak rate for all components except the aircraft or instruments about to be tested.

D. STATIC and PITOT Test Set Leak Test – (*Test Set and hoses only*)

Confirm hoses connected to both Ps and Pt ports on 1811NG.
 Confirm the other end of each hose is sealed with an AN4 plug.
 Determine the method of Leak Test, Method-(1) Leak Rate Timer, continue with the following steps (B-3.1) or Method-(2) ATP Leak Test, begin with step (B-4.1)

- (1) Using Method-(1) Leak Rate Timer.

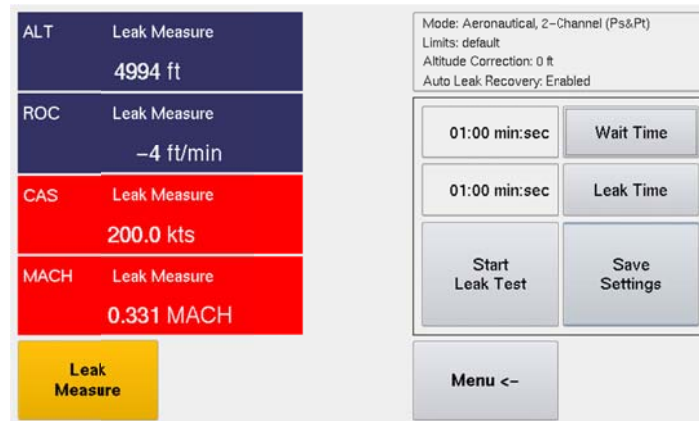

Figure 51 Leak Test Timer Screen

- (2) Select Control mode, after for Wait Resuming Control to finish.
- (3) Select ALT Target = enter the desired altitude to perform the leak test.
- (4) After establishing the Target altitude, select Leak Measure mode.
- (5) From the Main menu, select Leak Testing, Leak Rate Timer.
- (6) Review the Wait Time and Measure Time.
- (7) Select Start Leak Test.
- (8) After the Wait cycle and Measure cycle have completed a message “Leak Test Completed Select Ok to view results” will be displayed.
- (9) Record or note the ALT Leak rate.
- (10) Select ← Menu, ←Menu, ←Menu.
- (11) You are now positioned back at the root menu.
- (12) Select Go To Ground, followed by “Yes” to confirm Go To Ground.
- (13) Wait for Test Set to reach Ground (ambient pressure altitude). Test Set will display “Unit Safe at Ground”.
- (14) The Test Set will automatically switch into Leak Measure mode with the PITOT (Pt) and STATIC (Ps) ports Vented to ambient and the pumps will be powered off.
- (15) This completes leak testing the Ps channel using Method-(1) Leak Rate Timer.
- (16) Select Control mode, after for Wait Resuming Control to finish.
- (17) Select ALT Target = enter the desired altitude to perform the leak test.
- (18) After establishing the Target altitude, select Leak Measure mode.
- (19) From the Main menu, select Leak Testing, Leak Rate Timer.
- (20) Review the Wait Time and Measure Time.
- (21) Select Start Leak Test.
- (22) After the Wait cycle and Measure cycle have completed a message “Leak Test Completed Select Ok to view results” will be displayed.
- (23) Record or note the ALT Leak rate.

- (24) Select ← Menu, ←Menu, ←Menu.
- (25) You are now positioned back at the root menu.
- (26) Select Go To Ground, followed by “Yes” to confirm Go To Ground.
- (27) Wait for Test Set to reach Ground (ambient pressure altitude). Test Set will display “Unit Safe at Ground”.
- (28) The Test Set will automatically switch into Leak Measure mode with the PITOT (Pt) and STATIC (Ps) ports Vented to ambient and the pumps will be powered off.
- (29) This completes leak testing the Ps channel using Method-(1) Leak Rate Timer.

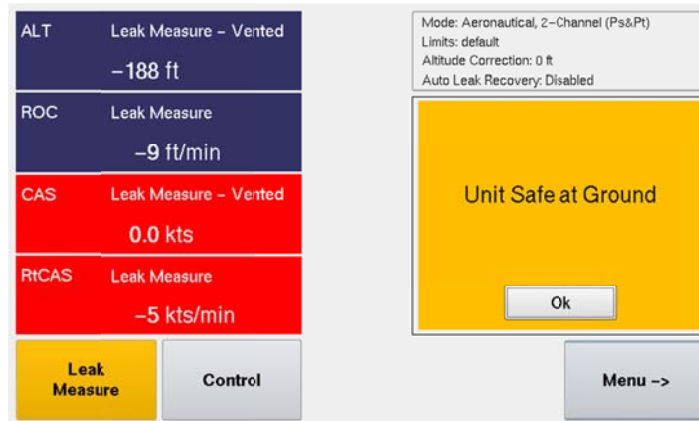

Figure 52 Leak Rate Timer, Unit Safe at Ground

- (30) Using Method-(2) ATP Leak Test.

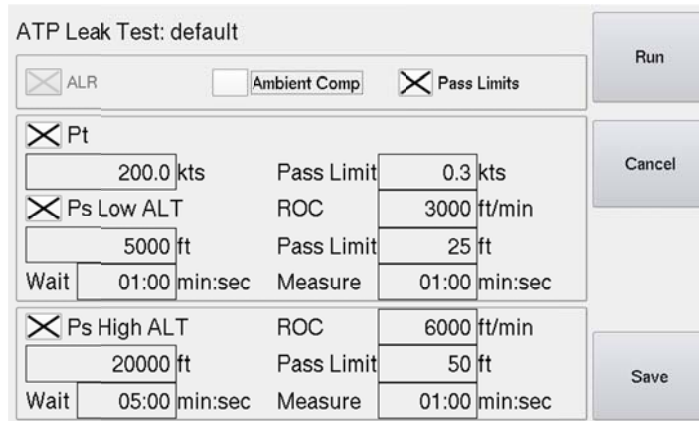

Figure 53 ATP Leak Test

Note: It is highly recommended that the user perform the Test Set Only (with hoses attached to Test Set and capped) prior to performing the Aircraft Leak Test.

- (31) From the main menu, select Leak Testing, Leak Test Profiles.
- (32) Now you can either select an existing profile by selecting “Select Leak Test Profile(s)” or “Create Leak Test Profiles”(see ATP Leak Test Profiles).
- (33) Follow the AMM “Aircraft Maintenance Manual” or appropriate documents regarding the specific leak test required. This information will be required to create/define the appropriate and safe ATP Leak Test profile.
- (34) From the ATP Leak Test GUI screen, review/select the Leak Test parameters as required.
- (35) After the parameters for the ATP Leak Test have been entered and configured as required, select Run.
- (36) With Run selected, depending on the configuration of the Leak Test ATP, the automated leak test process will begin.
- (37) If Pt Leak Test was selected it will be tested 1st. This test is always performed while Ps is at ground “ambient pressure”.

Note: If Ps ALT is not at ground pressure, a Go To Ground will be performed before starting the Pt Leak Test.

- (a) If Ps Low ALT was selected it will be tested 2nd.
- (b) If Ps High ALT was selected, it will be tested 3rd.
- (c) At the conclusion of the ATP Leak Test the 1811NG will automatically perform a Go To Ground function and the following screen will display the results:

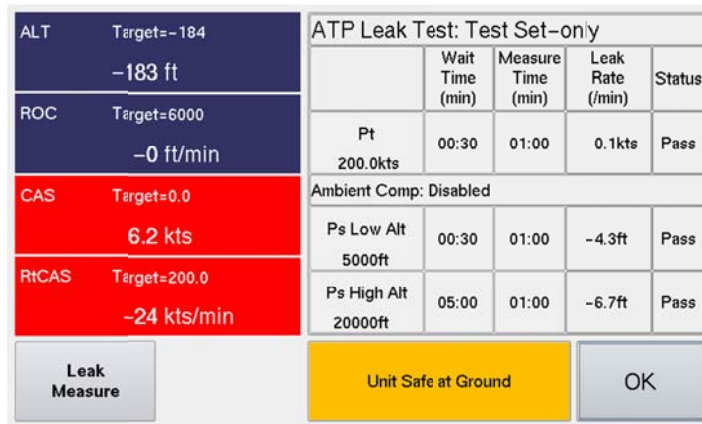

Figure 54 ATP Leak Test Results

- (38) This concludes the ATP Leak Test.

E. APPLYING LEAK CORRECTION

If the leak rate does not exceed 2 kts/min or 50 ft/min, record the leak rate of the test set and hoses so that the values can be subtracted from the aircraft’s leak test. The calculated value removes the leaks caused by the Test Set and hoses, and isolates the aircraft systems’ leak rate.

11. AIRCRAFT TESTING

CAUTION: Observe all safety precautions detailed in the “AMM” Aircraft Maintenance Manual.

CAUTION: When using STATIC (Ps) static only, make sure that the differential pressure “Qc” stays within the limits of the ASI “Airspeed Indicator”.

A. PRELIMINARY SETUP

- (1) Ensure the “STATIC and PITOT Test Set Leak Test – (*Test Set and hoses only*) has been completed and that the 1811NG is “Safe at Ground” and Vented before connecting the tester to the aircraft systems.

Note: The ports on the test set and mating hoses are color-coded to help prevent the accidental crossing of Pitot and Static hoses.

- (2) Using a Barfield Inc. universal adapter or another manufacturer’s custom aircraft pitot adapter, connect the PITOT (Pt) port hose (*red band*) to the aircraft pitot system as referenced in the aircraft maintenance manual. Using the Barfield Inc. 2423F Static Port adapter or another manufacturer’s custom aircraft static adapter, connect the STATIC (Ps) port hose (blue band) to the aircraft static system, as referenced in the aircraft maintenance manual.

Note: Some aircraft have more than one static port associated with a given static system. Make sure that other ports in the system being tested are sealed before continuing.

- (3) Set the aircraft altimeter baro setting to 29.92 inHg (*1013.25 mbar*).
- (4) View and select the appropriate Limits on the 1811NG for the Aircraft / Instruments to be tested.
- (5) If necessary, (from the Main menu) select Display Setup to configure display for the Aeronautical display parameters required.
- (6) If necessary, (from the Main menu) select Units to configure the display for the Units required.

B. LEAK TESTING - Combined ALT & CAS (using traditional Leak Rate Timer)

- (1) If the display indicates “Leak Measure”, select the CONTROL key to toggle the 1811NG into the “Control” mode.
- (2) Select CAS touch zone, the key pad screen will be displayed with the “CAS = kts” parameter indicated in the user entry window.
- (3) Enter the desired CAS “Airspeed” value (for example, 300) and press ENTER.
- (4) The test set and aircraft will begin moving towards the airspeed entered.
- (5) If a different ROC rate is required, select ROC touch zone, the keypad screen will be displayed with the “ROC = ft” parameter indicated.
- (6) Enter the desired ROC “Vertical Speed”.
- (7) Select ALT touch zone, entry the desired altitude value required for the leak test altitude.
- (8) The test set and aircraft / instruments will begin moving towards this altitude at the VSI rate entered.

- (9) Allow test set to stabilize at Target values for a minimum of 10 seconds before selecting Leak Measure mode.
- (10) While in Leak Measure mode, select Leak Testing.
- (11) Select Leak Rate Timer.
- (12) If required, set the Wait time and Measure time to the values required.

Note: The default values are (Wait=1:00) minute and (Measure=1:00) minute for CAS airspeed and low altitude (typ < 10,000 ft). For High ALT (typ > 10,000 ft) additional wait time is recommended (Wait=5:00) or more may be required to allow the adiabatic to settle so the leak measurement will represent the actual leak rate.

Note: The 1811NG is capable of conducting a combined Pitot and Static test (as described above) or individual system leak tests. To accomplish a single channel (Pitot only or Static only) modify the procedures by simply not entering Target value for the parameter / channel. For example, for Pt only Leak check, the ALT target would remain at ambient Ground pressure altitude while the CAS Target would be set at the desired CAS airspeed value. In this example, if the Test Set STATIC (Ps) channel is not already at ambient "Ground" pressure, 1st perform a "Go To Ground" function, then set CAS Target to desired airspeed.

- (13) If additional Leak Test at other altitudes or airspeeds is required, repeat steps (1) through (12) above for any additional test points.
- (14) Once Leak Test is completed, select the Go To Ground function to returning the 1811NG to ground ambient pressure.
- (15) When Test Set and aircraft have reached ambient Ground pressure the pumps will be powered off and the Test Set will remain Vented to ambient until the Control mode is selected.

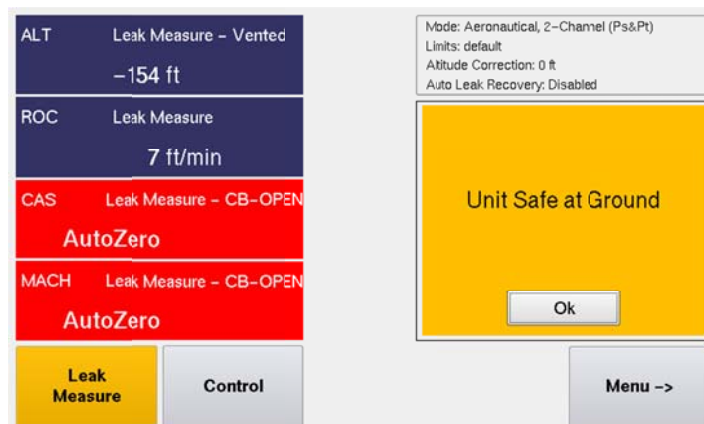

Figure 55 Unit Safe at Ground

C. LEAK TESTING - Combined ALT & CAS (using ATP Leak Test Profile)

The ATP Leak Test Profile feature provides an automated process for Leak Testing. Once a profile is created and saved it can be used to automate the Leak Test process allowing the user to perform other tasks while the ATP Leak Test is running.

- (1) For detail explanation of the ATP Leak Test capability and parameter field descriptions, reference section B-3.30 "Using Method-(2) ATP Leak Test".

- (2) Verify the 1811NG including hoses and the Aircraft Pitot System Leak Test and Static System Leak Tests have been completed.

Note: It is always recommended that prior to performing any testing the 1811NG test set and hoses should be known to be leak tight. The reality is every Test Set and hose configuration has some level of leakage present, a confirmation of the existing leak rate is important to establish prior to trying to determine the leak rate of the aircraft or instruments in question.

- (3) Verify if the alternate pneumatic system(s) (co-pilot, standby auxiliary, etc.) share the same pneumatic lines, if so they must be sealed.
- (4) Ensure the aircraft altimeter has the baro set at 29.92 inHg (1013.25 mbar).
- (5) Select the appropriate Limit values for the aircraft / Instrument's to be tested.

Note: If the appropriate limits file does not exist go into Setup 2 and create the limit file:

- (a) Menu →
- (b) Setup 2
- (c) Enter user PIN (default PIN: 123456)
- (d) Limits Create/Edit/Delete
- (e) Create Custom Limits - enter the parameter values for ALT, ROC, CAS, RtCAS, MACH, and ALR "Auto Leak Recovery"

CAUTION: Using incorrect limits can cause damage to sensitive components and aircraft systems.

Note: Before creating new limits refer to the appropriate AMM "Aircraft Maintenance Manual" or CMM "Component Maintenance Manual" for the actual minimum and maximum values to be applied.

- (6) Enter the Altitude Correction value if required.
 - (a) Menu →
 - (b) Setup 1
 - (c) Altitude Correction
 - (d) Read message, select "Ok"
 - (e) Enter Altitude correction value. The height difference between the aircraft system or instrument under test and the 1811NG test set.
- (7) Using the AMM or CMM, select the appropriate Leak Test ATP Leak Test Profile.
 - (a) Leak Testing
 - (b) ATP Leak Testing
 - (c) ATP Select Leak Test Profile(s)
 - (d) Select the appropriate profile to perform the Leak Test as specified by the AMM or CMM
 - (e) If required, the default ATP profile can be selected and the parameters can be changed to the values specified by the AMM or CMM.
 - (f) If the ATP profile value(s) or process(s) (Pt, Ps Low ALT, Ps High ALT) are changed, the user can select "Save" and name the ATP profile with an appropriate name for future use.

- (8) Once the ATP Leak Test profile has been configured and parameters are verified correct, select “Run”.

Note: The Leak Test ATP is a fully automatic feature that proceeds as follows:

- (a) 1st (if selected) the Pt leak test will be performed. If the STATIC (Ps) port is not at ambient Ground pressure the ATP will begin by performing a Go to Ground function prior to starting the Pt leak test
- (b) 2nd (if selected) the Ps Low ALT leak test will be performed.
- (c) 3rd (if selected) the Ps High ALT leak test will be performed.
- (d) On completion of the 3rd (or last) selected leak test, the Test Set will perform a Go To Ground function.
- (e) Once the test set and aircraft or instrument(s) under test are safe at ground “ambient” pressure, the Leak Test results will be displayed (Figure 56).

ALT	Target=-184	ATP Leak Test: Test Set-only				
	-183 ft		Wait Time (min)	Measure Time (min)	Leak Rate (/min)	Status
ROC	Target=6000	Pt	00:30	01:00	0.1kts	Pass
	-0 ft/min	200.0kts				
CAS	Target=0.0	Ambient Comp: Disabled				
	6.2 kts	Ps Low Alt	00:30	01:00	-4.3ft	Pass
RtCAS	Target=200.0	5000ft				
	-24 kts/min	Ps High Alt	05:00	01:00	-6.7ft	Pass
		20000ft				
Leak Measure		Unit Safe at Ground			OK	

Figure 56 Leak Test Results

- (f) Record the leak test results
 - (g) If additional leak test at other altitudes or airspeeds is required, select the appropriate ATP Leak Test profile or edit the values in the repeat steps 8 and 9 above for any additional test points.
- (9) This completes the Combined ATP Leak Test process.

D. Testing the Aircraft Static System

CAUTION: Observe all safety precautions detailed in the AMM and or CMM.

CAUTION: The AMM or CMM procedure should always be recognized as the primary authority and this manual should be recognized as a secondary aide. As such the primary objective of this manual is to provide instruction relevant to general test set operation while the AMM or CMM dictates the specific test process, sequences and values.

- (1) Verify the 1811NG is powered ON and that Initialization has completed and that the system is safe at Ground and that the display indicates “Vented”.

- (a) If required, select Go To Ground and wait for the Test Set to indicate “Unit Safe at Ground”.
- (2) Connect the hoses, both Static (Ps) and Pitot (Pt) to the 1811NG ports.

Note: The Pitot (Pt) hose is not required to perform a Static system test however it is highly recommended as a safety precautions to protect the ASI from possible does.

- (3) If not already done, perform a Leak Test on the Test Set and hoses.

Note: CAP the aircraft end of each hose.

- (4) Connect the hoses to the aircraft Static and Pitot ports.

Note: Using the Pitot (Pt) hose for a Static system test will prevent the possibility of damaging the ASI “Airspeed Indicator” which can happen if the Static (Ps) channel is driven to a high altitude while testing and creates a large differential pressure which could exceed the ASI full scale rating.

Note: While testing the Static (Ps) system, the Target value for CAS should remain at 0 kts. While testing various altitude levels, the Test Set will maintain 0 kts (Qc = 0.000 inHg pressure differential) between the Ps and Pt ports which will ensure the ASI is not damaged.

- (5) Verify if the alternate pneumatic system(s) (co-pilot, standby auxiliary, etc.) share the same pneumatic lines, if so they must be sealed or isolated from the current pneumatic system about to be tested.
- (6) If necessary change the displayed parameters on the test set to those required. This can be accomplished by selecting Display Setup followed by selecting the aeronautical parameters desired.
- (7) If necessary different units can be selected by selecting Units.
- (8) Verify the limits selected are appropriate for the aircraft and or Instruments that are going to be tested.
- (9) If there is a height difference between the test set and the aircraft or instruments about to be tested, enter the Altitude Correction.
 - (a) Menu →, Setup 1, Altitude Correction, enter the altitude difference (with aircraft / instruments higher than test set the value would be entered as a (+) positive number).
- (10) At this time confirm the following has been accomplished:
 - (a) The test set and hose combination have been leak tested
 - (b) The test set hose(s) Static (Ps) and Pitot (Pt) has been connect to the aircraft or instrument to be tested
 - (c) The test set limits have been configured with the appropriate vales to protect the aircraft system or instrument(s) about to be tested
 - (d) If required, the altitude correction value has been entered
- (11) Select the Control soft-key.

- (a) The test set will transition from Leak Measure to Control mode. You will notice the ALT and CAS target will be preloaded with the current pressure altitude and CAS values.
- (b) Wait for Resuming Control phase to complete (typically 4 seconds)
- (12) Set the ROC Target value as specified by the AMM, CMM or AP “authorized procedure”.
- (13) Set the ALT Target value as specified by the AMM, CMM or AP.
- (14) Continue with the next ALT Target value required:
 - (a) For test procedures requiring small step changes in ALT are required, there is a “Nudge” feature available that will simplify having to enter multiple small changes in Target values.
 - (b) The “Nudge” key is located on the same pop-up keypad used for entering a new Target value.
 - (c) The Nudge value can also be re-defined.
- (15) On completion of the Static system testing, select the Go to Ground function and wait for the “Unit is Safe at Ground” to be displayed.
- (16) This completes the “Testing the Aircraft Static System”.

E. Testing the Aircraft Pitot System

CAUTION: Observe all safety precautions detailed in the AMM and or CMM.

CAUTION: The AMM or CMM procedure should always be recognized as the primary authority and this manual should be recognized as a secondary aide. As such the primary objective of this manual is to provide instruction relevant to general test set operation while the AMM or CMM dictates the specific test process, sequences and values.

- (1) Verify the 1811NG is powered ON and that Initialization has completed and that the system is safe at Ground and that the display indicates “Vented”.
 - (a) If required, select Go To Ground and wait for the Test Set to indicate “Unit Safe at Ground”
- (2) Connect the Pitot (Pt) port of the 1811NG to the aircraft or ASI instrument being tested.

Note: The Static (Ps) hose is not required to perform a Pitot system test if the test set is configured for “1-Channel Pt Only” mode.

- (a) When the test set is operated in the default 2-Channel Ps & Pt mode, both the Static and Pitot hose must be connected to the Aircraft to create a leak tight system. For operating in this configuration go to the next section “**Combine Testing of the Aircraft Pitot and Static System**”.
- (3) If performing a Pitot only test, configure the 1811NG for 1-Channel Pt only mode as follows:

Note: Test Set should be Vented to ambient and in Leak Measure mode at this time.

- (a) Menu →, Setup 1, Control Mode, Control Mode (Pt Only)
- (b) Menu ←, Menu ←, Menu ←

Note: The UI display is now positioned back to the Main Menu.

- (4) If not already accomplish, perform a Leak Test on the Test Set and hoses.

Note: CAP the aircraft end of each hose.

- (5) Connect the hoses to the aircraft Pitot ports.

Note: While testing the Pitot (Pt) system with test set configured as 1-Channel (Pt only) mode, the Static (Ps) channel of the test set will remain vented to ambient, this is the same point of reference the aircraft's Static port is referencing while drive the Pitot system with the test set.

- (a) If the test set is configured in its (default: 2-Channel Ps & Pt) mode, the Target value for ALT should always remain at ambient Ground pressure altitude (value determined from the last Go To Ground). While testing various CAS values, the Tester will maintain ambient pressure altitude equivalent on the Static (Ps) port.
 - (b) This is very important that the Test Set maintains ALT = ambient pressure altitude especially if Static (Ps) hose is not connected to aircraft's Static system.
- (6) Verify if the alternate pneumatic system(s) (co-pilot, standby auxiliary, etc.) share the same pneumatic lines, if so they must be sealed or isolated from the current pneumatic system about to be tested.
- (7) If necessary, change the displayed parameters on the test set to those required. This can be accomplished by selecting Display Setup followed by selecting the aeronautical parameters desired.
- (8) If necessary, different units can be selected by selecting Units.
- (9) Verify the limits selected are appropriate for the aircraft and or Instruments that are going to be tested.
- (10) At this time confirm the following has been accomplished:
 - (a) The test set and hose combination have been leak tested.
 - (b) The test set Pitot (Pt) has been connect to the aircraft or instrument to be tested.
 - (c) The test set limits have been configured with the appropriate vales to protect the aircraft system or instrument(s) about to be tested.
- (11) Select the Control soft-key.
 - (a) The test set will transition from Leak Measure to Control mode. You will notice the ALT and CAS target will be preloaded with the current pressure altitude and CAS values.
 - (b) Wait for Resuming Control phase to complete (typically 4 seconds).
- (12) Set the ROC Target value as specified by the AMM, CMM or AP "authorized procedure".
- (13) Set the ALT Target value as specified by the AMM, CMM or AP.
- (14) Continue with the next ALT Target value required:
 - (a) For test procedures requiring small step changes in ALT are required, there is a "Nudge" feature available that will simplify having to enter multiple small changes in Target values.
 - (b) The "Nudge" key is located on the same pop-up keypad used for entering a new Target value.
 - (c) The Nudge value can also be re-defined
- (15) On completion of the Static system testing, select the Go to Ground function and wait for the "Unit is Safe at Ground" to be displayed.
- (16) This Completes the "Testing the Aircraft Static System".

F. Combine Testing of the Aircraft Pitot and Static System

CAUTION: Observe all safety precautions detailed in the AMM and or CMM.

CAUTION: The AMM or CMM procedure should always be recognized as the primary authority and this manual should be recognized as a secondary aide. As such the primary objective of this manual is to provide instruction relevant to general test set operation while the AMM or CMM dictates the specific test process, sequences and values.

(1) Verify the 1811NG is powered ON and that Initialization has completed and that the system is safe at Ground and that the display indicates “Vented”.

(a) If required, select Go To Ground and wait for the Test Set to indicate “Unit Safe at Ground”

(2) Connect the hoses, both Static (Ps) and Pitot (Pt) to the 1811NG ports.

Note: The Pitot (Pt) hose is not required to perform a Static system test however it is highly recommended as a safety precautions to protect the ASI from possible does.

(3) If not already accomplish, perform a Leak Test on the Test Set and hoses.

Note: CAP the aircraft end of each hose.

(4) Connect the hoses to the aircraft Static and Pitot ports.

(5) Verify if the alternate pneumatic system(s) (co-pilot, standby auxiliary, etc.) share the same pneumatic lines, if so they must be sealed or isolated from the current pneumatic system about to be tested.

(6) If necessary change the displayed parameters on the test set to those required. This can be accomplished by selecting Display Setup followed by selecting the aeronautical parameters desired.

(7) If necessary different units can be selected by selecting Units.

(8) Verify the limits selected are appropriate for the aircraft and or Instruments that are going to be tested.

(9) If there is a height difference between the test set and the aircraft or instruments about to be tested, enter the Altitude Correction.

(a) Menu →, Setup 1, Altitude Correction, enter the altitude difference (with aircraft / instruments higher than test set the value would be entered as a (+) positive number).

(10) At this time confirm the following has been accomplished:

(a) The test set and hose combination have been leak tested

(b) The test set hose(s) Static (Ps) and Pitot (Pt) has been connect to the aircraft or instrument to be tested

(c) The test set limits have been configured with the appropriate vales to protect the aircraft system or instrument(s) about to be tested.

(d) If required, the altitude correction value has been entered

(11) Select the Control soft-key.

(a) The test set will transition from Leak Measure to Control mode. You will notice the ALT and CAS target will be preloaded with the current pressure altitude and CAS values.

(b) Wait for Resuming Control phase to complete (typically 4 seconds).

- (12) Set the ROC Target value as specified by the AMM, CMM or AP “authorized procedure”.
- (13) If required, verify/set the value for RtCAS as specified by the AMM or CMM. The default value is 300 kts/min
- (14) Set the ALT Target values and CAS Target values as specified by the AMM, CMM procedures.
- (15) Continue with the next ALT Target value or CAS Target value as required
 - (a) For test procedures requiring small step changes in ALT or CAS, there is a “Nudge” feature available that will simplify having to enter multiple small changes in Target values.
 - (b) By touching the appropriate touch zone area “ALT”, “CAS”, “MACH” the Target keypad will appear (only in Control mode). The value can be entered directly by keypad or the Nudge key can be selected which will then provide the Nudge function screen.
 - (c) The “Nudge” key is located on the same pop-up keypad used for entering a new Target value.
 - (d) The Nudge value can also be re-defined.
- (16) On completion, select the **Go to Ground** function and wait for the “Unit is Safe at Ground” to be displayed.
- (17) This Completes the “Combine Testing of the Aircraft Pitot and Static System”.

G. MACH Test and Constant MACH

The 1811NG can provide either constant CAS “calibrated airspeed” or constant MACH. The parameter which is held constant is determined by which Target parameter the user enters as a set point. If the user selects CAS touch zone and enters the Target for CAS then CAS becomes the controlling parameter for the PITOT (Pt) channel. Similarly, if the user enters a MACH Target value then MACH is the controlling parameter.

With a Target value entered for MACH “i.e. Constant MACH”, once the 1811NG reaches the Target MACH value, the PITOT (Pt) channel controller will continue to maintain the MACH value requested while the STATIC (Ps) Target value is changed by the user entering a different ALT Target.

Note: While operating in constant MACH mode (ie MACH Target set by user) each time the user changes the ALT Target value you will noticed the equivalent CAS Target will be automatically computed and updated as the equivalent CAS Target for the given MACH and ALT Targets requested. You will also notice that when operating in the constant MACH mode, the CAS Target parameter will be ghosted as a reminder that CAS is not the controlling parameter during constant MACH mode.

- (1) If required, from the Main Menu select Display Setup and select ALT, ROC, CAS, MACH display format.
- (2) Select Control mode.
- (3) Wait for Resuming Control to complete.
- (4) Enter the Target value for MACH.
- (5) Wait for MACH Target to be achieved.
- (6) The controller will maintain the MACH target value while the user selects various ALT target values.

- (7) On completion of the Constant MACH testing, select Go To Ground and wait for the Test Set to indicate “Unit is Safe at Ground” to be displayed.
- (8) At this time hose can be disconnected from the Test Set.

H. AIRSPEED SWITCH TEST

- (1) If required, from the Main Menu select Display Setup and select ALT, ROC, CAS, MACH display format.
- (2) Select **Control** mode.
- (3) Enter the Target CAS value below the operating limits of the switch.

Note: For an airspeed switch with a 140 kts \pm 2 kts trip point, start with a CAS Target of ~136 kts.

- (4) If necessary change the RtCAS Target low enough to observe the switch operation.
- (5) Wait for initial CAS Target to be achieved.
- (6) Select CAS touch zone, on Target keypad select “Nudge Mode”.
- (7) Use the Nudge **Up** key to slowly increase the CAS Target value until the Airspeed switch trip point is determined.

Note: If required the Nudge value “CAS Nudge = 0.x kts” can be changed by selecting the Define Nudge soft key.

- (8) Record the trip point where the switch contacts (closed).
- (9) Use the Nudge Down key to slowly decrease the CAS Target value until the Airspeed switch operates (opens).
- (10) Record the trip point where the switch contacts (open).
- (11) On completion of the Airspeed switch testing select the Go To Ground function and wait for the “Unit Safe at Ground” message to be displayed.

Note: The above method Nudge feature can be used with any of the Controlled Target parameters such as ALT, ROC, MACH, RtCAS, Ps, Pt, EPR.

12. ENGINE PRESSURE RATIO (EPR) TEST

Note: This test is limited by Test Set airspeed range.

A. Preliminary

- (1) Connect the PITOT (Pt) port (red band) to the PT7 (Hi) port of the EPR transmitter to be tested.
- (2) Connect the STATIC (Ps) port (blue band) to the PT2 (Lo) port of the EPR transmitter to be tested.

B. Test

- (1) The EPR function of the 1811NG allows the display of the EPR Ratio PT7/PT2 and also pressures of PT2 and PT7 individually. The units of measure available for the PT2 and PT7 pressure display are: inHg, mb, or Altitude (ft or m) and Airspeed (kts or km/h). To set up the EPR display to desired units of measure, refer to Table 6.

Note: If the EPR data is displayed in Altitude (ft) and Airspeed (kts), Table 6 can be referenced as a guide to establish the desired EPR Ratio.

- (2) Establish the respective static (Altitude or PT2) and pitot (Airspeed or PT7) pressure combination to achieve the desired EPR ratio.

Engine Pressure Ratio		
AIRSPPEED (knots) Pt7 (Hi) Port	ALTITUDE (feet) Pt2 (Lo) Port	EPR (Engine Pressure Ratio)
650	25,870	3.4
546	35,000	3.4
650	21,650	3.0
504	35,000	3.0
650	14,690	2.5
534	25,870	2.5
444	35,000	2.5
650	4,210	2.0
500	20,000	2.0
369	35,000	2.0
478	5,000	1.5
365	20,000	1.5
265	35,000	1.5

Table 6 Engine Pressure Ratio Test Table

- (3) After testing has been completed, use the Standard Test Set Shutdown Procedures to return the test set and aircraft to ambient pressures.

13. SHUTDOWN PROCEDURE

A. Test Set Shutdown Procedure

- (1) From the Main Menu, select the Go To Ground function.
- (2) Confirm the Go To Ground, Yes.

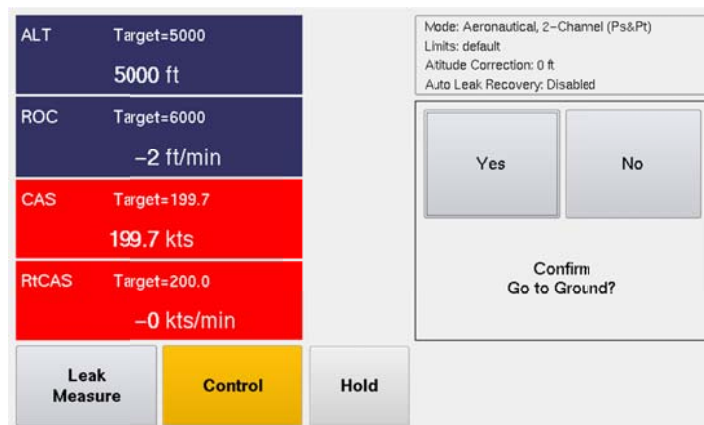

Figure 57 Confirm Go To Ground

Note: When the Go to Ground function has completed, the display will indicate “Unit Safe at Ground” and both the STATIC (Ps) and PITOT (Pt) ports are Vented to ambient.

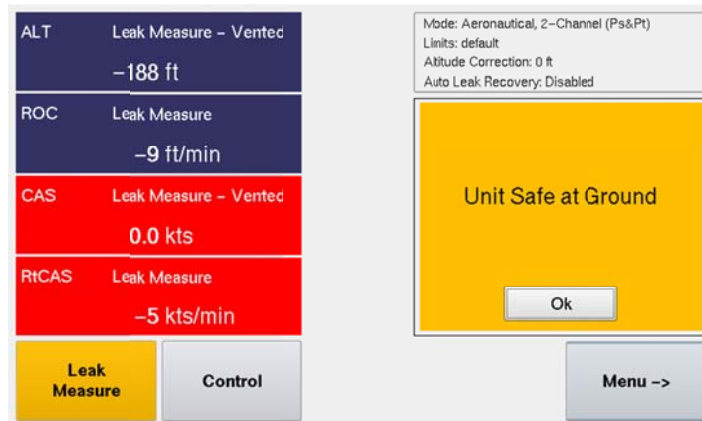

Figure 58 Unit Safe at Ground

- CAUTION:** Do not remove STATIC (Ps) or PITOT (Pt) hose or Nav-Aids adapters before Test Set displays “Unit Safe at Ground”.
- (3) Switch Power OFF.
 - (4) Disconnect the STATIC and PITOT hoses from the aircraft ports and or adapters.
 - (5) Disconnect the STATIC and PITOT hoses from the tester ports.

CHAPTER 4: RECEIVING, SHIPPING, AND STORAGE

1. RECEIVING

No special unpacking procedures are necessary. It is recommended that the factory-shipping container and packing materials be retained should it become necessary, for any reason, to re-ship the Test Set, such as for the O.E.M. recertification.

It is also recommended that the Test Set undergo a leak check upon receipt and its carrying case should be carefully inspected for damage. If the test set has an excessive leak or is damaged immediately, notify the carrier and the manufacturer.

2. SHIPPING

- A. It is recommended that the factory-shipping container and packing materials be retained should it become necessary, for any reason, to re-ship the Test Set, such as for the O.E.M. recertification.
- B. Insure the unit is Safe at Ground.
- C. Disconnect hoses from the Static and Pitot ports and install AN4 caps on each.
- D. Insure unit is powered off, disconnect the power cable and store in lid pouch.
- E. Reaffix the lid if previously removed.
- F. Use standard delicate electronic equipment packaging procedures when packing the Test Set for reshipment.

3. STORAGE

- A. Place a four-ounce bag of desiccant inside the case.
- B. Close and latch the cover.
- C. Store in a cool dry place.

Note: Should the test set become exposed to moisture or very high humidity, dry it as soon as possible and temporarily store it in a dehumidified area.

CHAPTER 5: MAINTENANCE

1. GENERAL

- A. The manufacturer of this equipment does not recommend the user to attempt any maintenance or repair. In case of malfunction, contact the manufacturer, to obtain the list of approved repair facilities worldwide, ensuring that this equipment will be serviced using proper procedures and certified instrument.

2. PREVENTATIVE

- A. The user should visually inspect the unit prior to each use looking for signs of apparent damage.
- B. Inspect the ports, hoses and aircraft adapters for the presence of moisture or any type of foreign matter.
With the 1811NG disconnected from the hose and adapter assemblies power the unit on and observe the initialization routines to insure no issues are reported.

3. TROUBLESHOOTING

- A. If the unit displays an error code during use then please record the error code and contact Barfield or its representative for instructions before proceeding further.
- B. If the unit seems to be malfunctioning but displays no error code, then with the unit returned safe to ground level, cycle the power to see if the problem clears noting any issues discovered during the Power On Self Test routines.

4. CALIBRATION

- A. The 1811NG calibration interval is once per annum (12 months).
- B. Please see the list of approved repair facilities under Maintenance and Repair Information on Page v of this document for approved repair facilities.

CAUTION: Recertification by a calibration/repair shop **not** possessing the necessary technical knowledge, documentation, special test equipment, tooling and standards will adversely affect the accuracy/capability of the 1811NG for testing the aircraft.

Appendix A: Abbreviations & Glossary

abs	Absolute
AAM	Aircraft Maintenance Manual
ALT	Altitude (ft or m).
ASI	Airspeed Indicator
CAS	Calibrated airspeed (kts or km/h)
CMM	Component Maintenance Manual
EPR	Engine pressure ratio
°F	Degrees Fahrenheit
°C	Degrees Celsius
Fig.	Figure
ft	Foot
g	Gauge
hr	Hour
hm	Hecto meter
inHg	inches of Mercury
HUIM	Host User Interface module
Hz	Hertz
IAS	Indicated Airspeed
in	Inch
kg	Kilogram
km	Kilometer
kts	Knots
LCD	Liquid crystal display
m	Meter
max	Maximum
mbar	Millibar
min	Minute or minimum
mm	Millimeter
mph	Miles per hour
mV	Millivolt
PCM	Pneumatic Control module
PIN	Personal identification number

Ps	Static Pressure
psi	Pounds per square inch
Pt	Pitot Pressure
PsRt	Ps Rate, rate of Ps pressure change
PtRt	Pt rate, rate of Pt pressure change
Qc	Differential pressure ($Qc = Pt - Ps$)
QFE	Local atmospheric pressure
QNH	Barometric pressure at sea level
ROC	Rate of climb in units of (ft/min or m/min)
Rt	Rate
RtCAS	Rate of change of CAS in units of (kts/min) or (km/h/min)
RtQc	Qc rate, rate of Qc pressure change
TAS	True airspeed (Adjusted for ambient temperature) – Not Supported

Appendix B: Operating Limits

The 1811NG is supplied with 2 pre-defined sets of operating limits, these we refer to as the **default** limits profile and **max** limits profile. The unit has limits files for each of the 3-modes of operation, **Aeronautical, Pressure units** and **EPR**. There will be a **default** limits profile for each of the 3-modes, these values are stored in a R/O “read only” file. There will also be a **max** limits profile for each of the 3-modes, these values are also stored in a R/O file. The Test Set will power up and initialize with the **default** limits when the product first ships. If the customer changes the limits to the **max** or a custom limits profile, the test set will power up using the last profile selected. The following are the **default** limits profile values:

Aeronautical Limits Profile – (default)		
Parameters	Limits	Comments
ALT Min	-1,500 ft { -460 m }	Minimum Target Altitude
ALT Max	50,000 ft { 15,240 m }	Maximum Target Altitude
ROC Min	100 ft/min { 30 m/min }	Minimum Target ROC
ROC Max	6,000 ft/min { 1,830 m/min }	
ROC - (default)	3,000 ft/min { 900 m/min }	
CAS Min	0.0 kts	Target = 0.0 or >= 5.0 kts
CAS Max	500 kts { 926 km/h }	
RtCAS Min	50 kts/min { 100 km/h/min }	
RtCAS Max	450 kts/min { 850 km/h/min }	
RtCAS – (default)	300 kts/min { 550 km/h/min }	
MACH Min	0.03	Target = 0.0 MACH or >=0.03
MACH Max	0.90	
ALT Correction Min	-100 { -30 m }	
ALT Correction Max	+100 { 30 m }	
ALR: Auto Leak Recovery	Enabled (default)	
ALR: ROC	1,000 ft/min { 300 m/min }	
ALR: RtCAS	100 kts/min { 185 km/h/min }	

Table 7 Aeronautical Limits Profile – (default)

Aeronautical Limits Profile – (max)		
Parameters	Limits	Comments
ALT Min	-2,000 ft { -610 m }	Minimum Altitude
ALT Max	55,000 ft { 16,765 m }	
ROC Min	100 ft/min { 30 m/min }	
ROC Max	20,000 ft/min { 6,000 m/min }	
ROC – (default)	3,000 ft/min { 900 m/min }	
CAS Min	0.0	
CAS Max	650 kts { 1,200 km/h }	
RtCAS Min	50 kts/min { 95 m/min }	
RtCAS Max	600 kts/min { 1,000 km/h/min }	
MACH Min	0.00	
MACH Max	3.0	
ALT Correction Min	-100	
ALT Correction Max	+100	
ALR: Auto Leak Recovery	Enabled (default)	
ALR: ROC	2,000 ft/min { 600 m/min }	
ALR: RtCAS	200 kts/min { 370 km/h/min }	

Table 8 Aeronautical Limits Profile – (max)

Operating Limits (con't)

Pressure Limits Profile – (default)		
Parameters	Limits	Comments
Ps Min	2.693 inHg	Ps Minimum Pressure
Ps Max	32.000 inHg	Ps Maximum Pressure
Qc Min	0.000 inHg	Qc Minimum Pressure
Qc Max	30.000 inHg	Qc Maximum Pressure
Pt Min	2.693 inHg	Pt Minimum Pressure
Pt Max	62.000 inHg	Pt Maximum Pressure
PsRt Min	0.10 inHg/min	Ps Minimum Rate
PsRt Max	16.0 inHg/min	Ps Maximum Rate
QcRt Min	0.50 inHg/min	Qc Minimum Rate
QcRt Max	10.0 inHg/min	Qc Maximum Rate

Table 9 Aeronautical Limits Profile – (default)

Pressure Limits Profile – (max)		
Parameters	Limits	Comments
Ps Min	2.693 inHg	Ps Minimum Pressure
Ps Max	38.000 inHg	Ps Maximum Pressure
Qc Min	0.000 inHg	Qc Minimum Pressure
Qc Max	40.000 inHg	Qc Maximum Pressure
Pt Min	2.693 inHg	Pt Minimum Pressure
Pt Max	78.000 inHg	Pt Maximum Pressure
PsRt Min	0.50 inHg/min	Ps Minimum Rate
PsRt Max	10.0 inHg/min	Ps Maximum Rate
PsRt – (default)	3.0 inHg/min	Ps default Rate
QcRt Min	0.10 inHg/min	Qc Minimum Rate
QcRt Max	10.0 inHg/min	Qc Maximum Rate
QcRt – (default)	3.0 inHg/min	Qc default Rate

Table 10 Aeronautical Limits Profile – (max)

Operating Limits (con't)

Note: **EPR** = P_t / P_s (where P_s = Inlet pressure and P_t = Outlet pressure)

EPR Limits Profile – (default)		
Parameters	Limits	Comments
Ps Min	2.693 inHg	Ps Minimum Pressure
Ps Max	32.000 inHg	Ps Maximum Pressure
Pt Min	2.693 inHg	Pt Minimum Pressure
Pt Max	62.000 inHg	Pt Maximum Pressure
EPR Min	0.10	EPR Minimum
EPR Max	12.0	Ps Maximum Rate
RtEPR Min	0.50 inHg/min	EPR Minimum Rate
RtEPR Max	10.0 inHg/min	EPR Maximum Rate
RtEPR (default)	3.0 inHg/min	EPR default Rate

Table 11 EPR Limits Profile – (default)

Note: **EPR** = P_t / P_s (where P_s = Inlet pressure and P_t = Outlet pressure)

EPR Limits Profile – (max)		
Parameters	Limits	Comments
Ps Min	2.693 inHg	Ps Minimum Pressure
Ps Max	38.000 inHg	Ps Maximum Pressure
Pt Min	2.693 inHg	Pt Minimum Pressure
Pt Max	78.000 inHg	Pt Maximum Pressure
EPR Min	0.10	Ps Minimum Rate
EPR Max	15	Ps Maximum Rate
RtEPR Min	0.50 inHg/min	EPR Minimum Rate
RtEPR Max	10.0 inHg/min	EPR Maximum Rate
RtEPR (default)	3.0 inHg/min	EPR default Rate

Table 12 EPR Limits Profile – (max)

Appendix C: 1811NG Internal Pneumatic Diagram

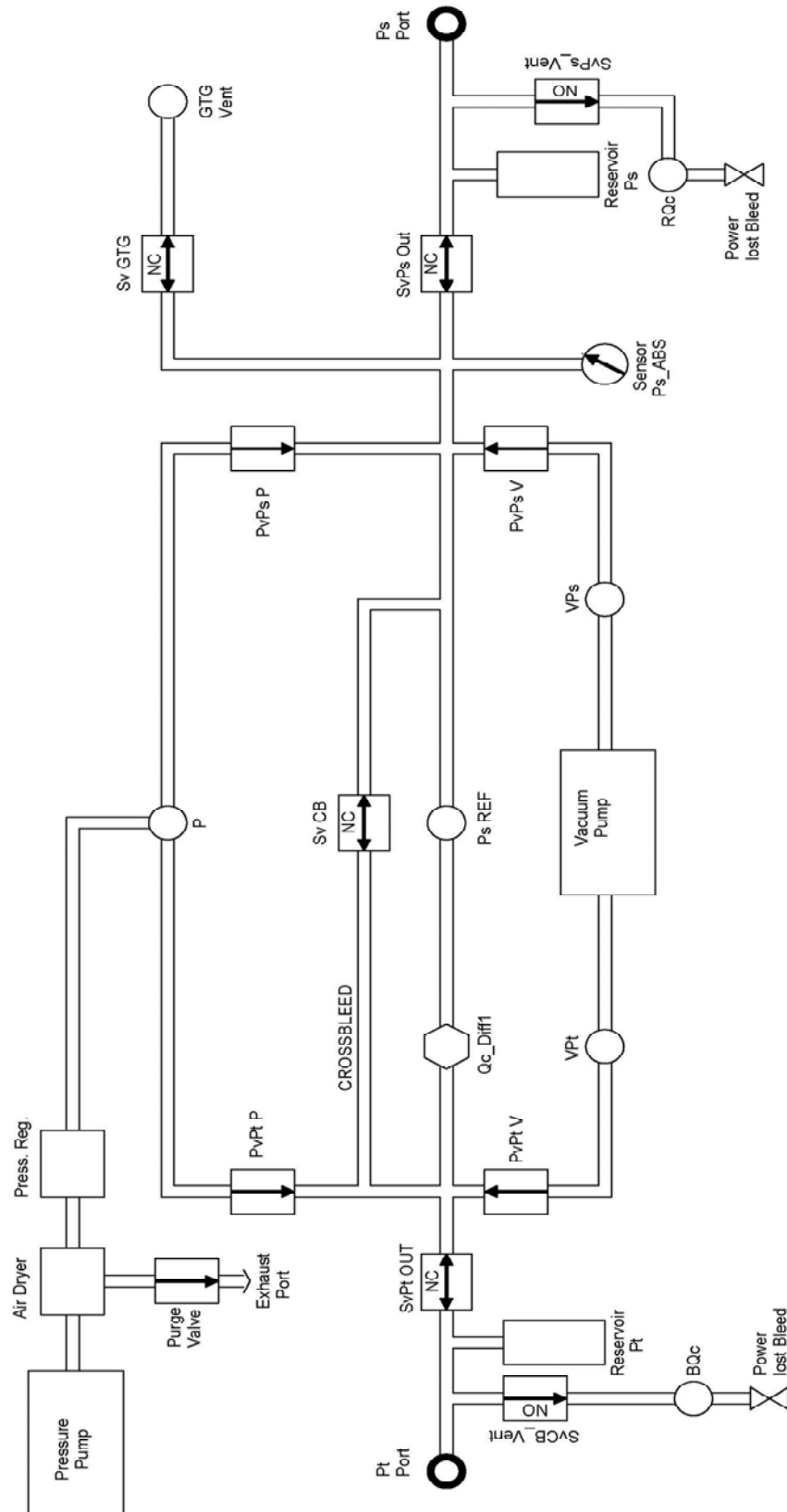

Appendix D: Menu Navigation

1811NG MENU NAVIGATION

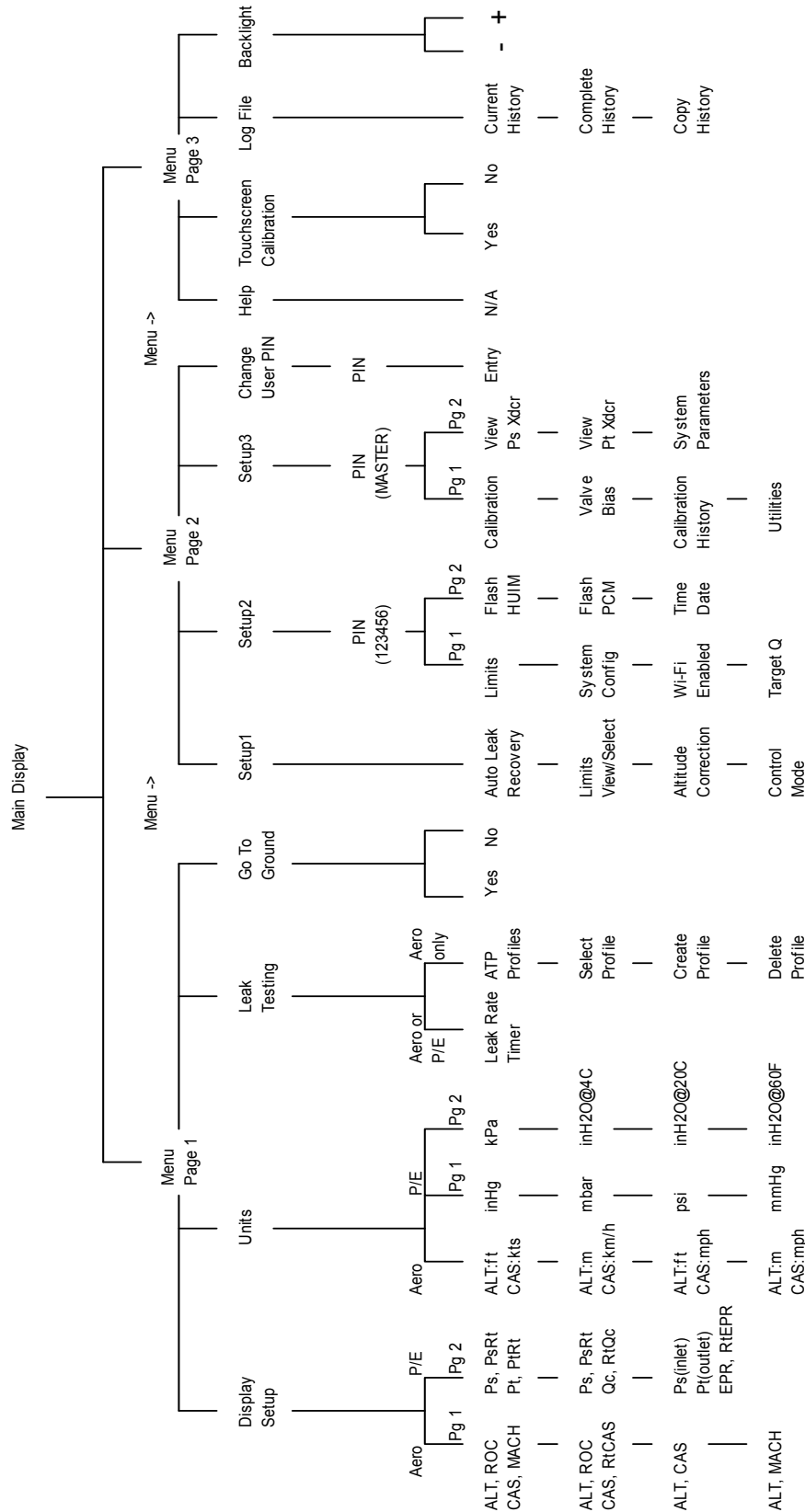

Aero = Aeronautical, P/E = Pressure/EPR

Units for Aeronautical and Pressure/EPR are determined by which is selected under Display Setup

Appendix E: Tablet App Wi-Fi Connect Procedure

If the tablet does not already have the “Barfield ADTS” installed, proceed with the following step(s), otherwise skip to step 2 below:

1. If application is not installed on the tablet, continue with the following step “1-a”, otherwise skip to step “2” below.
 - A. Installing “Barfield ADTS” app on tablet.
 - B. For Apple iOS select “App Store”, for android tablet select “Play Store”.
 - C. Search for “Barfield ADTS”.
 - D. Select “install”.

2. Connecting the Tablet Wi-Fi to 1811NG Test Set

Before trying to connect the tablet to the test set, verify the test set power ON and operational or at a minimum after the initial Barfield logo screen is displayed and replaced by the initialization status window.

Note: Before launching the Barfield ADTS app, the tablet Wi-Fi connection must be established with the Test Set.

- A. Select Settings .
- B. Set Wi-Fi to “1” ON.
- C. View Wi-Fi Networks to identify the Test Set you are trying to connect to. The 1811NG will be identified as “1811NG_00xxx” where “xxx” is the S/N of the Test Set.



Figure 59 Wi-Fi Settings Screen Example

- D. Select the 1811NG_00xxx Test Set.
- E. If prompted for a password, enter “barfield” (all lower case).
- F. Wait to verify that Wi-Fi Networks lists the “1811NG_00xxx” as Connected.
- G. Continue with step “3” below.

3. Launch the “Barfield ADTS” app on the tablet
 - A. Now you can launch the Barfield tablet Application, once it loads it will indicate “1811NG Remote Terminal” (Version: x.x)
 - B. On the tablet App, select “Connect”
 - C. It will indicate “Connecting Host” and if all goes well, the Tablet will display the remote terminal which will be identical to the Test Set(s) display

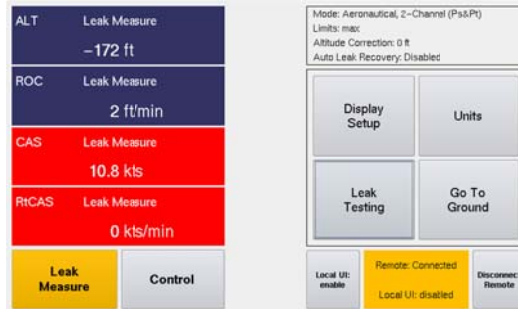

Figure 60 Test Set Menu when tablet remote is connected

- D. At this time the **tablet** is the master “UI” with an active touch screen. While the **tablet** is the master, the touch screen on the test set is disabled.
 - **Note:** the test set display will continue to replicate the same screens as selected and displayed on the tablet but the UI touch will only be active on the tablet app.
 - When the **tablet** is the **master** UI, the test set display will indicate “Remote: Connected”, Local UI: disabled”. To regain touch control on the test set display, select “Local UI: enable” from the test set touch screen, the test set display will now be the **master** UI. The tablet app will continue replicating the test set display but the touch screen on the tablet will be disabled.

Appendix F: Field Firmware Update Procedure

The following Field Firmware Update Procedure (Document 42-101-01175_01178) details the process.

**DPS1000
1811NG****Pitot-Static Test Set**

Field Firmware Update Procedure
BARFIELD

For

P/N 101-01175 (DPS1000)

P/N 101-01178 (1811NG)

*Doc. P/N: 42-101-01175_01178 (Rev A)
February 5, 2014*

Corporate Headquarters

4101 Northwest 29th Street

Miami, Florida 33142

www.barfieldinc.com

Email: gsesales@barfieldinc.com

Barfield Inc. Confidential and Proprietary Information.

This document and all the information contained herein is the sole property of Barfield Inc.

No intellectual property rights are granted by the delivery of this document or the disclosure of its content.

This entire document is proprietary information and shall not be reproduced or disclosed to a third party without the express written consent of Barfield Inc.

This document and its content shall not be used for any purpose other than that for which it is supplied.

SECTION 1 – INTRODUCTION AND REQUIREMENTS

Your Imperium Series Digital Pitot Static Tester has a USB 2.0 port that is used to copy test set history log contents as well as for firmware updates via USB. To update your test set via this method, you will need to complete the following instructions.

Requirements:

- a working DPS1000 or 1811NG
- a PC with Internet access
- a storage media device, either a USB flash drive or a Memory Stick. On that storage media, you will need at least 2GB of free space

SECTION 2 - GETTING THE FIRMWARE UPDATE

First, download the firmware update and make sure the full update downloads.

You will have available to download the following software:

- HUIM (User Interface, supports both DPS1000 & 1811NG): **dpsx** file format
- PCM (Pneumatic controller, supports both DPS1000 & 1811NG): **controller.hex** file format

You will be able to download the software from the Barfield website to a computer, unzip and then copy the unzipped downloaded files to your media storage device.

If you are unable to do this, Barfield can send you a USB with the updated files, please contact the sales team.

Customer area | Contact us

BARFIELD

Home | About Barfield | Services & offers | Online searches | Processes & Quality | The AFI KLM E&M Network | Latest News

AIRFRANCE INDUSTRIES | KLM Engineering & Maintenance

Ground Support Test Equipment

Home > Services & offers > Ground Support Test Equipment

Ground Support Test Equipment

> Barfield RVSM Testers - 1811NG



The 1811NG performs altimeter and static systems tests and inspections directly supporting General Aviation, Helicopter, UAV, Non-RVSM Regional and Corporate aircraft. Critical components used in the 1811NG have well-established history of proven flight line reliability & accuracy - including case, pumps, valves, and pressure transducers.

Barfield introduced an innovative feature to the DPS1000 in 2013, wireless communication for display and control using the latest Wi-Fi technology. This wireless Wi-Fi technology is being carried through to the next imperium series product the 1811 NG.

- > [Brochure >1811NG](#)
- > [Air Data Feature Comparison Chart >1811NG](#)
- > [Instruction Manual >1811NG](#)
- > [Download the Field Firmware Update Procedure](#)
- > [Software Downloads: HUIM PCM](#)
- > [Get the apps!](#)



> Barfield RVSM Testers - DPS1000



Thanks to over 65 years of expertise and highly qualified engineers and technicians, Barfield has developed a new product category called the Imperium series. Imperium, a Latin word which in a broad sense, translates as 'power to command' represents new Barfield products containing a pressure controller or automated testing features. The newest product being introduced is the fully automated DPS1000 which replaces the successful DPS350 as our low cost flight line air data test set.

The DPS1000 is Barfield's latest fully automated, user-friendly RVSM compliant air data test set. Replacing the DPS350, the DPS1000 performs altimeter and static systems tests and inspections. Critical components used in the DPS1000 have a well established history of proven flight line accuracy including pumps, valves and static/altitude transducers.

- > [Brochure >DPS1000](#)
- > [Air Data Feature Comparison Chart >DPS1000](#)
- > [Instruction manual >DPS1000](#)
- > [Download the Field Firmware Update Procedure](#)
- > [Software Downloads: HUIM PCM](#)
- > [Get the apps!](#)



SECTION 3 - UPDATING THE HUIM USING THE USB PORT

1. Turn on the power of the unit that needs the software update.
2. Allow the initialization to complete. Once finished, the unit will display the main menu (display menu 1).
3. Press Menu key to go to display menu 2.

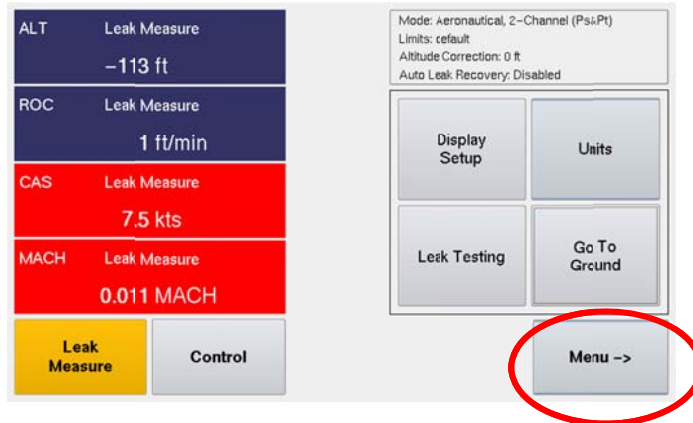

4. In menu 2, select **Setup2**.

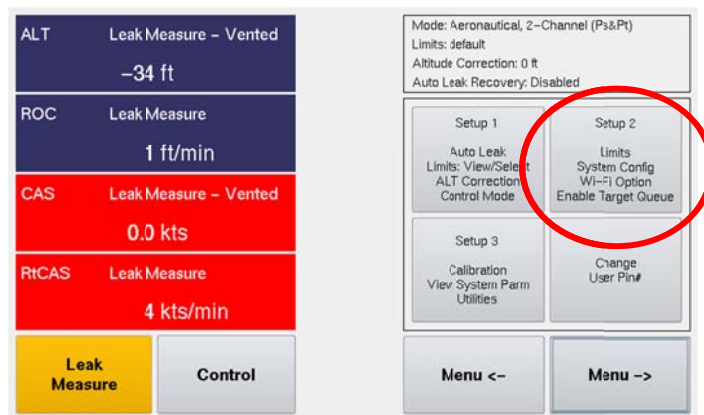

5. The unit will prompt for the User's Pin
6. Enter your pin. The default pin code is **123456** until you create a new code.



7. Unit will display the Setup 2 Menu selection.
8. Press **Menu ->** key.

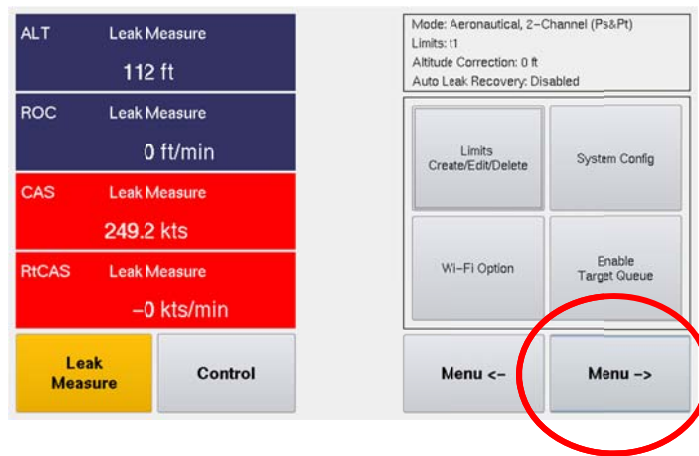

9. Unit will display the software download selection.
10. Press **Flash - HUIM from USB**.

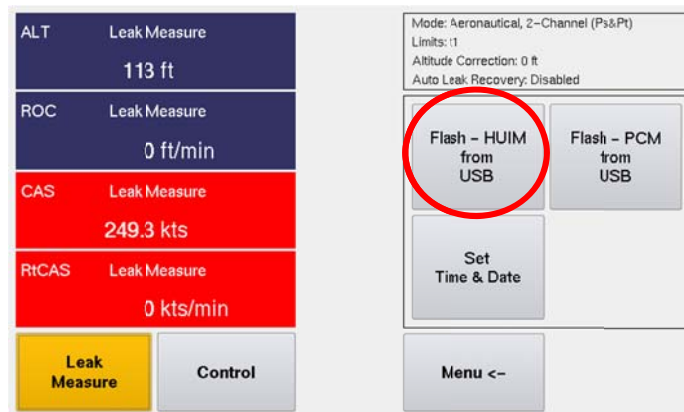

11. A "pop up" message will prompt you to insert the USB.

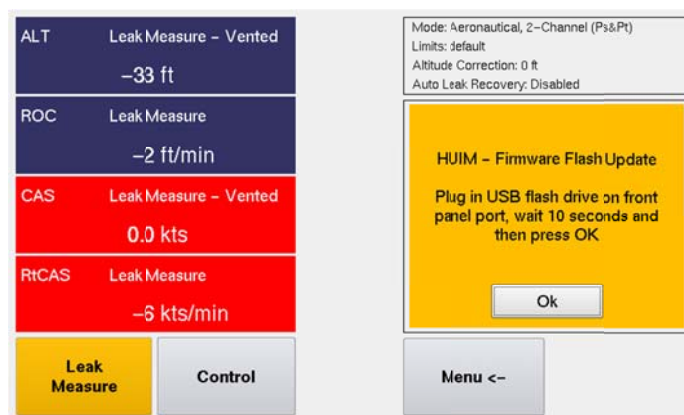

12. You should have a USB flash drive which contains the latest firmware files from Barfield. If necessary verify the USB flash drive contains the following two files:
 - dpsx (HUIM User Interface, supports both DPS1000 & 1811NG)
 - controller.hex (PCM – pneumatic controller, supports both DPS1000 & 1811NG)
13. Plug the USB flash drive in the front face USB of the DPS1000 or 1811NG and wait 10 seconds before pressing “OK” button.
14. The unit will display a progression bar during the installation (this process takes less than 10 seconds).

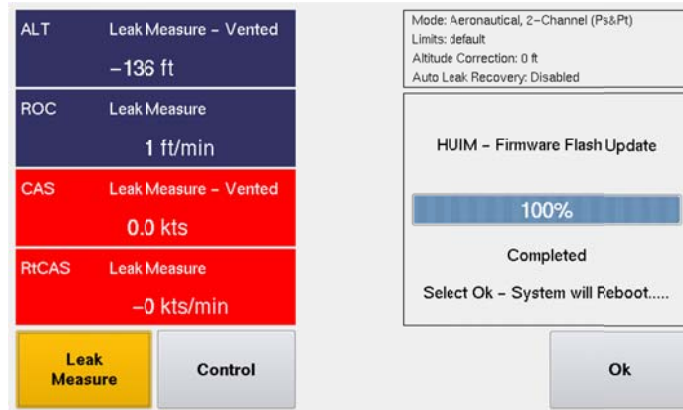

15. Once installation is complete, the unit will prompt you, “Completed, Select Ok – System will Reboot....” After selecting “OK”, the system will reboot and the updated HUIM firmware will now be operational.

Note: When updating from older HUIM firmware units (1.0, 1.1), the unit won’t automatically reboot after selecting “OK”, you will have to power cycle the Test Set OFF/ON after “100%” status bar is displayed. This is required for the updated HUIM firmware to be operational.



16. Allow the initialization to complete.

Notes:

- During the Test set initialization, after the HUIM update, it is not unusual to get ERROR messages in “Checking Vacuum pump” and “Checking Pressure pump”, this is expected and they will disappear once the PCM firmware is updated.
- Cancel the Go-to-Ground sequence.

17. After the HUIM firmware Installation and the initialization have been completed, you will typically get a message: **“Warning – PCM Firmware Requires Updating”**.

Note: If you don’t get the message your firmware update is complete and the unit is ready for use, do not proceed installing the PCM.

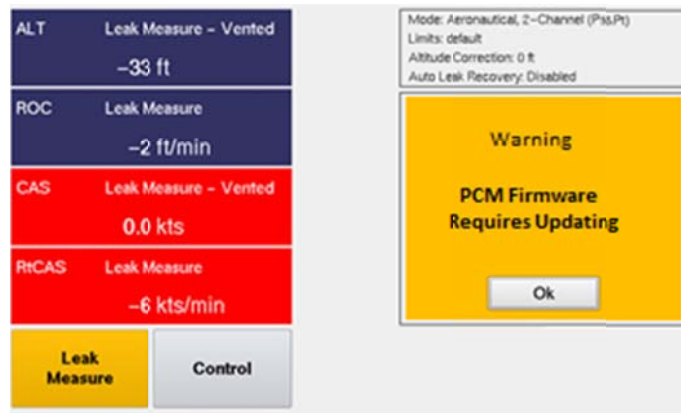

18. If the **“Warning – PCM Firmware Requires Updating”** is displayed, select **“OK”** and the menu below will appear. Press **“Flash – PCM from USB”** as shown below:



19. A “pop up” message will prompt you to insert the USB. Plug the USB flash drive in the front face USB of the DPS1000 or 1811NG and wait 10 seconds before pressing “OK” button.

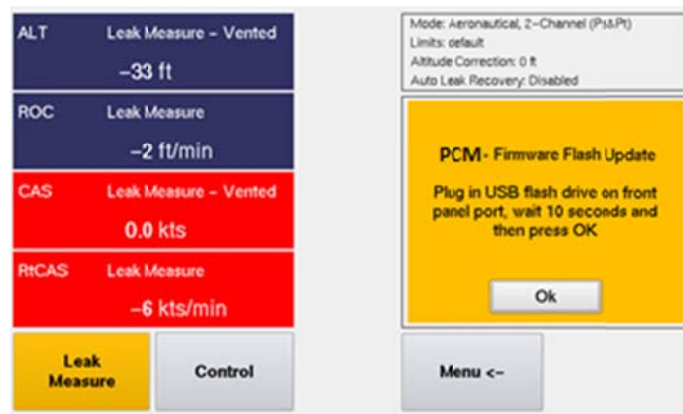

20. The unit will display a progression bar during the installation.

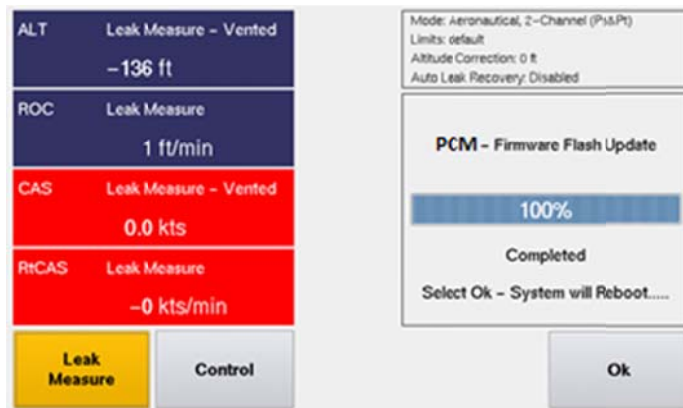

21. Once installation is complete, the unit will prompt you, “Completed, Select Ok – System will Reboot....” After selecting “OK”, the system will reboot and the updated PCM firmware will now be operational.
22. At this time, the Test Set has both the HUIM firmware upgrade and the PCM firmware upgrade installed.
23. Manually cycle power OFF/ON one last time to confirm Test Set proceeds through its normal power ON initialization process and take note of the Initialization Log window to confirm both the HUIM Ver (x.x.x) and the PCM Ver (x.x) appear with the version(s) expected.
24. The process is now complete and the unit is ready for use.