

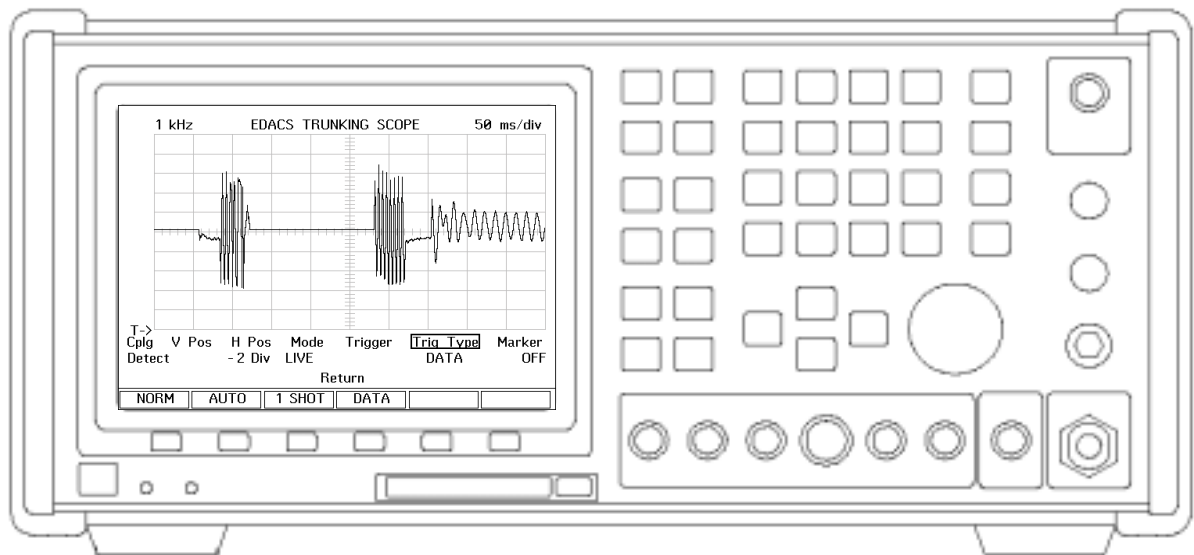

IFR COM-120B

Evaluation Guide







Thank you for taking the time to evaluate the IFR COM-120B. We know that your time is valuable, so we have included a demonstration kit complete with all of the accessories that you will need to evaluate the advanced features of the COM-120B.

This instrument is also supplied with a step by step procedure to lead you through the evaluation. In addition to the procedure, this instrument has been configured with a software application that will configure the equipment for each experiment.

Please use this guide and software, as it will allow you to rapidly see many of the advanced features offered by the COM-120B in a minimal amount of time.

The Operators guide and Programmers manual are also included if you would like to gain even more detailed information.

We invite you to contact our Tech Support group techsupport@ifrsys.com to receive a handy guide, the “RF DATAMATE” which provides much useful information for anyone working in the wireless industry. Just drop them a line and include your shipping information and one will be sent to you.

If you have any suggestions or comments to improve this procedure or if we have left something out, please drop us a line and we will try to implement the addition or change if possible.

EMAIL requests to:

TO: info@ifrsys.com

Subject: RTS Evaluation

Thank you again for taking the time to evaluate the IFR COM-120B.



IFR COM-120B

Evaluation Guide

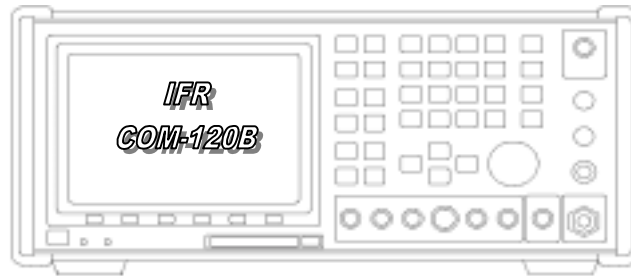

- RF Inputs and Outputs
- Audio Inputs and Outputs
- Rear Panel
- Basic Operation / Navigation
- Using the SETUP software
- Transmitter Testing
 - Power
 - Frequency
 - Voice Deviation
 - Scope Peak/Min Hold
 - Tone Decoding
 - CTCSS / DCS tone decode
 - CTCSS / DCS tone deviation
 - DTMF Decode
 - Transmitter Distortion
- Receiver Testing
 - Sensitivity
 - Audio Output Power
- Cross-band Duplex
- Spectrum Analyzer
 - Filter Tuning
 - Cable Fault
 - Return Loss

If you need assistance or have any questions about the COM-120B or performing any of the experiments in this guide, do not hesitate to call our toll free number: (800) 835-2352 and select menu item 1. You will be able to speak to a trained specialist who is well versed with this product.



RF Inputs and Outputs

The Antenna port is designed for low level off-the-air signals but has input protection for up to 10 Watts in case of accidental connection to transmitter.

Off the Air

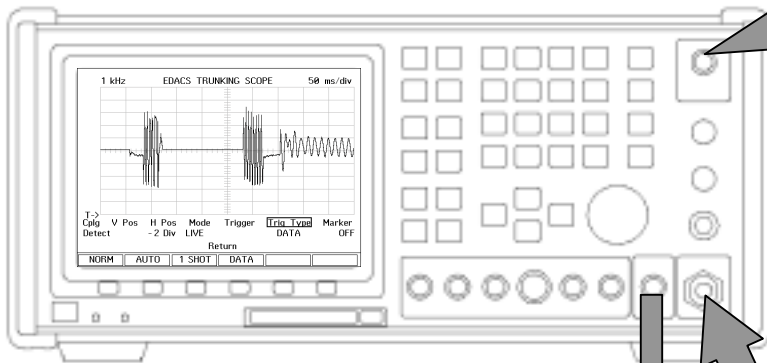
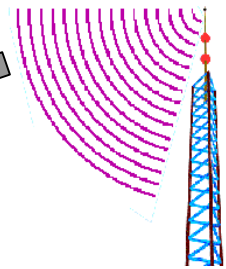

Transmitter
connection
Full Duplex
Testing

**Receiver
Half-Duplex
testing
+13 dBm
Tracking
Generator
Output**

**Transmitter
Input
Up to 50
Watts
Continuos**





Audio Inputs and Outputs

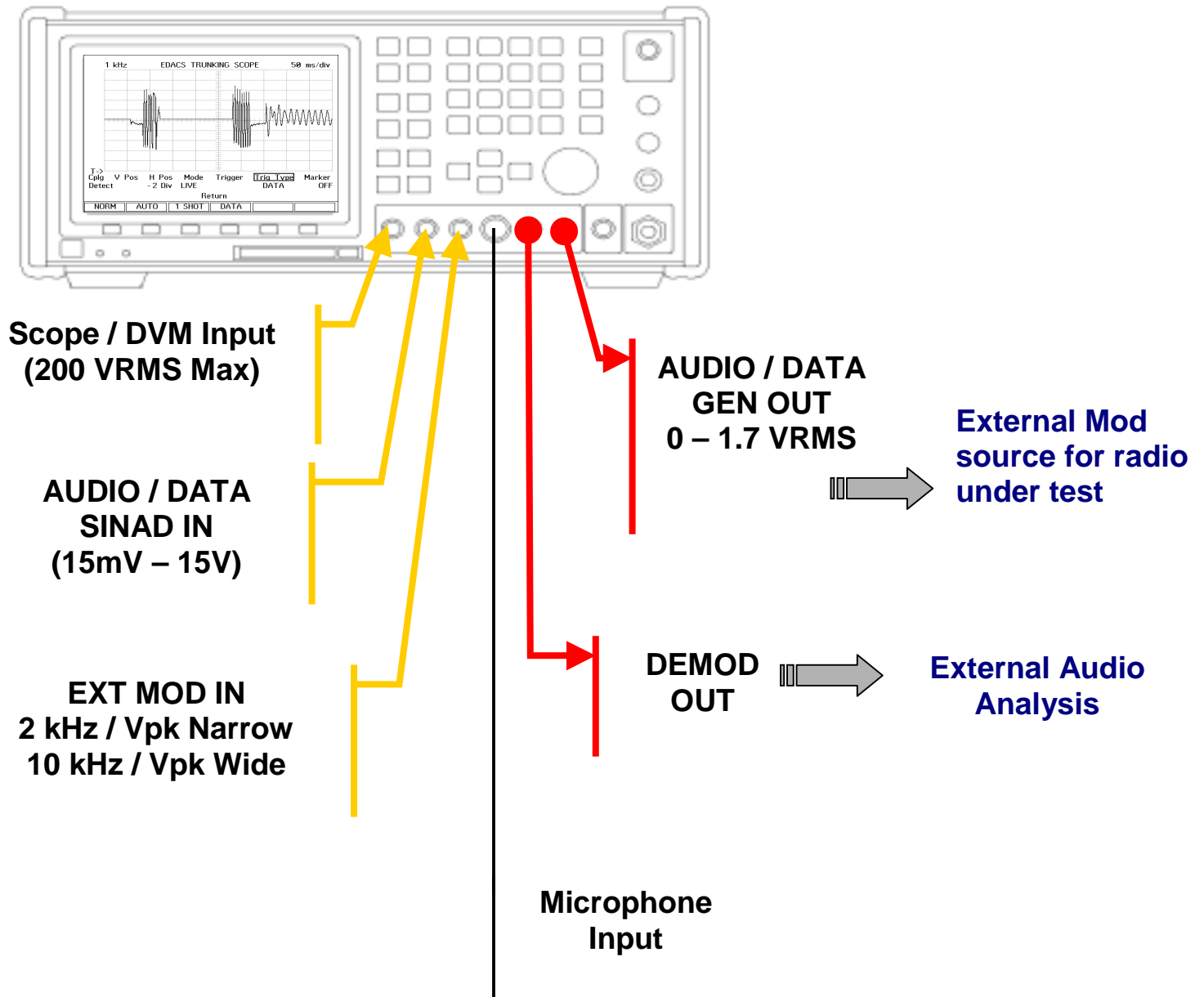



Rear Panel

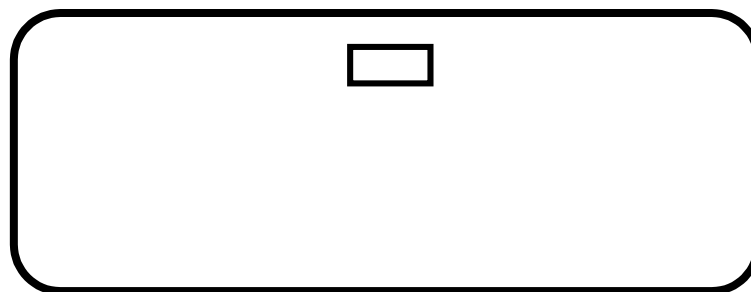
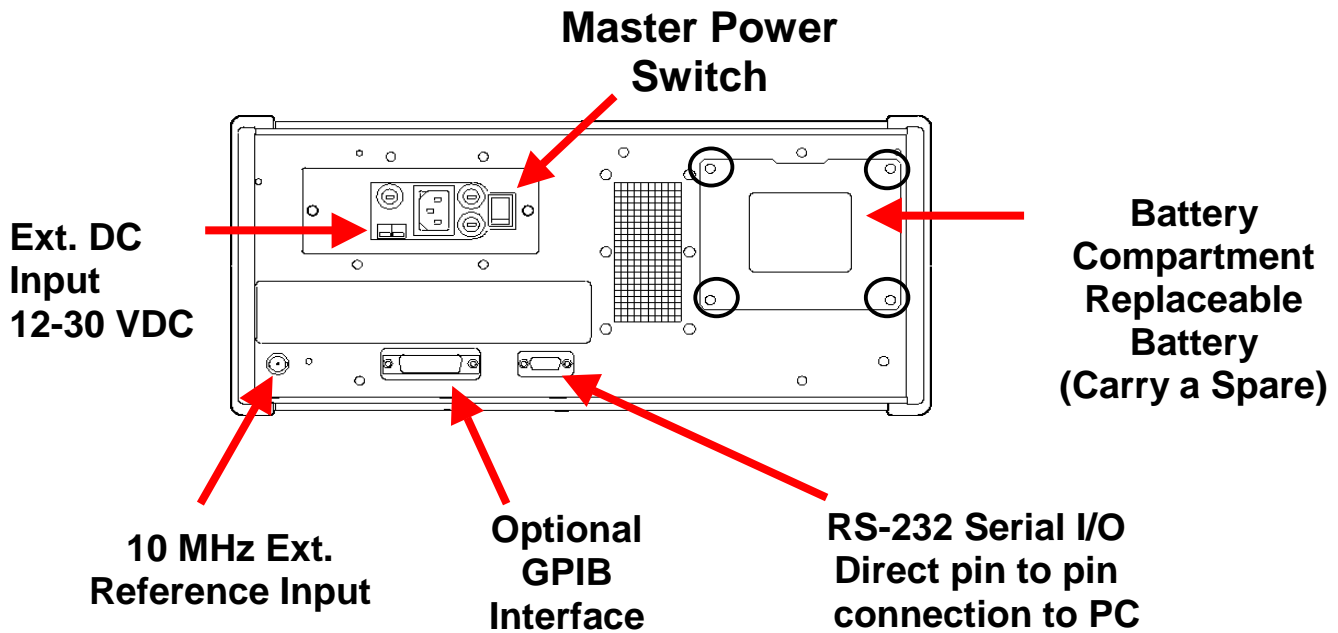

LID / Storage Unit

- AC Line Cord
- DC Line Cord
- Antenna
- Fuses
- Extra room for cables and connectors



Getting Familiar

For the purpose of demonstration, this demo unit has been configured with software to perform specific setups that coincide with this document. A description of the test setup is also provided. For maximum benefit, a kit has been included to allow testing of a radio, tuning of a filter and measurement of return loss.

The COM-120B provides a powerful set of instruments to allow repair, calibration and diagnostic evaluations of communications systems. The COM-120B organizes test functions into screens that can be selected and altered to perform specific tests. A powerful memory system allows storage and recall of test setups, frequency lists and test software for quick evaluation.

Primary Screens:

- GEN** **Test Receivers**
- REC** **Test Transmitters**
- DPLX** **Simultaneous Transmitter / Receiver test**
- SPCL** **Access optional Trunking Features and Tests**



Memory Functions:

- STORE** **Store and Label a test setup**
- RCL** **Recall a stored test setup**
- SHOW LIST** **Access test software**



Getting Started

1. Remove the connector kit from the Evaluation Kit and Connect the N-BNC adapter to the COM-120B's T/R RF IN/OUT connector located in the lower left corner of the instrument.
2. Remove the TNC-BNC adapter from the Evaluation Kit and connect the COM-120B's Antenna Input located in the upper right corner of the instrument.
3. Connect the AC Line cord to the COM-120B's rear panel receptical and apply power with the power switch located in the lower left corner of the instrument.

The COM-120B will begin it's power on sequence followed by a selftest. The Selftest can be aborted by pressing a mode key such as [REC].

The COM-120B should be preset to factory default conditions prior to performing any of the following procedures. To do this, press the [SETUP] key to access the system setup screen.



Press the down arrow key until item 12 is selected as indicated by the cursor box.

Press the [ENTER] key to activate Factory Defaults.

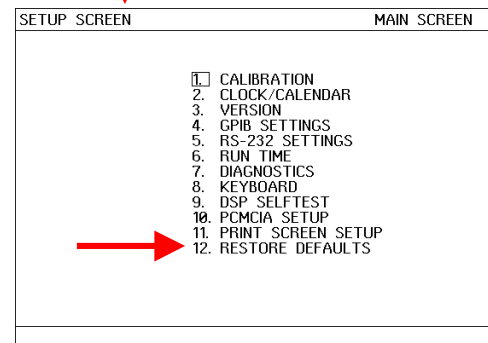



Basic Operation and Navigation

This guide will provide some basic operational knowledge to allow configuration of the COM-120B but you should consult the Operators Guide for more detailed information.

Begin by selecting a test mode of operation. Press the [REC] key now to enable the Transmitter Test screen. Screen settings are accomplished by positioning a cursor to a field label and establishing the desired setting. The cursor can be moved to a different field through use of the 4 arrow keys on the COM-120B's front panel. These keys are located to the left of the large knob in the **DATA SCROLL** section of the front panel.

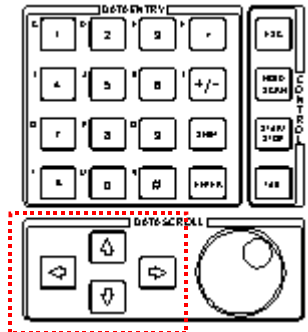

Changing Numeric fields:

To change the value of a numeric field such as the RF frequency:

1. Position the cursor to the field label (**RF**).
2. Use the numeric keypad to directly enter the frequency and terminate entry by pressing the [ENTER] key.

OR

3. Press the [ENTER] key to highlight the frequency field.
4. Use the left or right arrow keys to position the cursor to the digit to be changed and use the up and down arrows or the knob to adjust the value of the selected digit. Terminate the entry with the [ENTER] key.

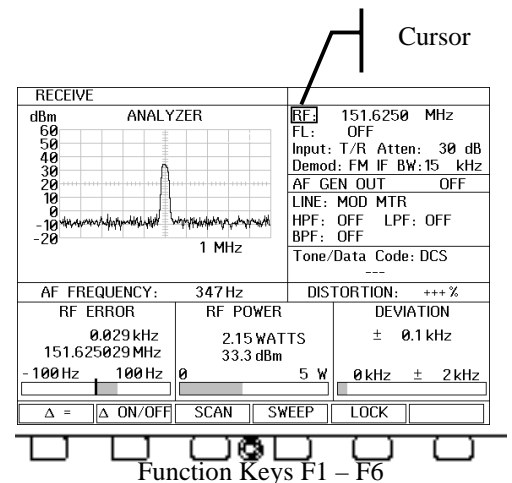

Other Field types:

Another type of field allows selection of an item by list or menu. The **INPUT** field (located just below the RF Frequency field) is an example of this type. Position the cursor to the INPUT field and press the [ENTER] key. With the field highlighted, press the up or down arrow key to cycle through the available list of selections. Set this field to **TR** and terminate the entry with the [ENTER] key.



With the cursor still on the INPUT field, notice that the F1 and F2 key labels offer quick entry of the available selections. Quick entry is available when there are only a few available options.

Some Field labels allow selection by **MENU** as shown in the screen image to the right. Position the cursor to the indicated position with the arrow keys. The Menu is selected by pressing the **F1** key below the **MENU** label. When the menu is displayed, a selection can be made by using the arrow keys to position the cursor to the desired selection. Press the **ENTER** key to terminate the selection.

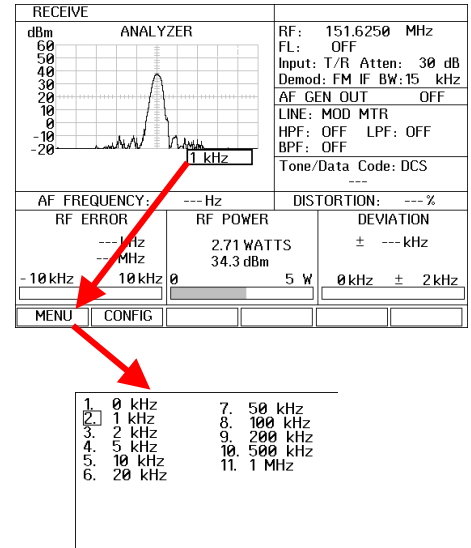

A Zooming feature allows expanded controls for the Scope, Spectrum Analyzer and Meter functions. By positioning the cursor to an appropriate field selection the **F1** key will offer a **ZOOM** option. In the case of the Scope or Spectrum Analyzer, the selected instrument will expand to consume the entire screen and more controls of that instrument will become available. Using the arrow keys, position the cursor to the **ANALYZER** field label and press the **F1** key to **ZOOM** in on that function.

To return to the originating screen function, press the desired mode key, **[REC]** in this case.

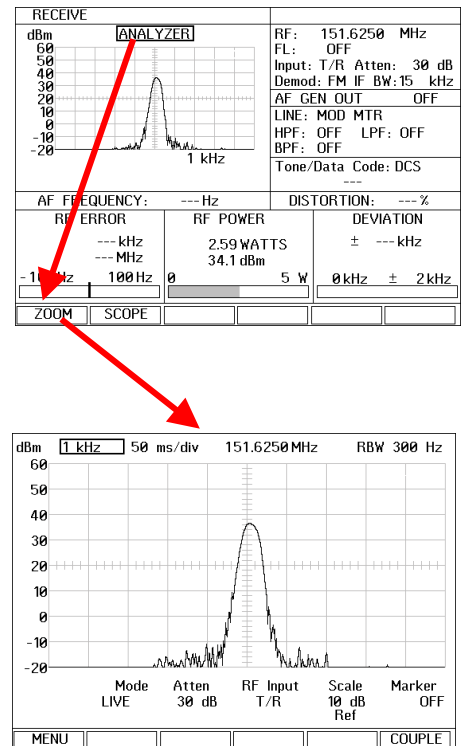



Meter functions allow for zooming as well. In the example to the right, the cursor is placed on the **RF Power** meter field label. This allows access to the zoom feature for the meter. Pressing the **[F1]** key will zoom in on the RF Power meter allowing additional features to be accessed. When a meter function is zoomed, the meter will display a bar graph, scope or spectrum analyzer and meter control functions.

Press the **[REC]** key to return to the Receiver screen.

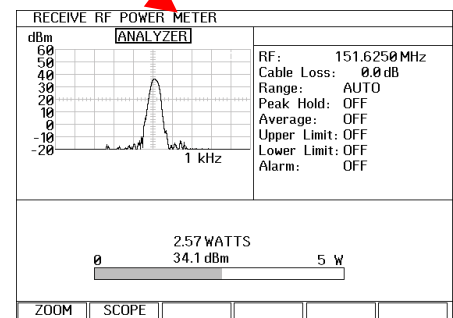
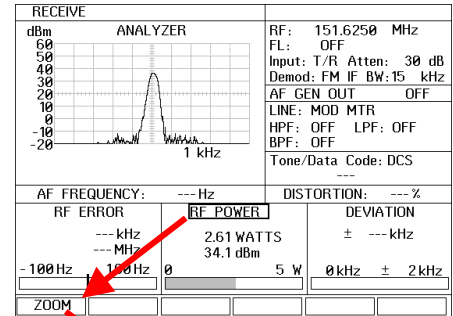

Pressing the **TAB** key allows direct access to any field label on the displayed screen. After pressing the TAB key, each field label will be identified by a numeric value. In the example to the right, the cursor can be moved directly to the RF Power meter field by pressing **[TAB] [1] [5] [ENTER]**.

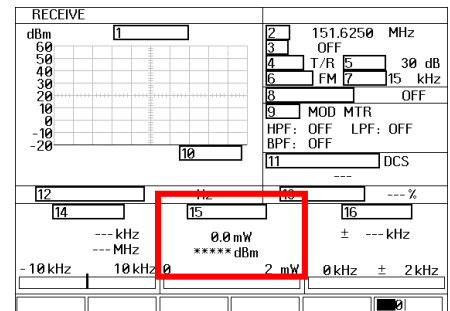
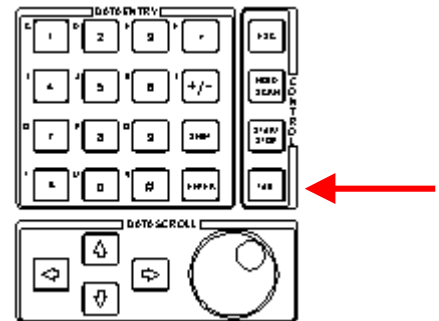



Setting up the Demonstration Software

To access the System Setup Software used in this document, a program must be activated from the COM-120B's file system. To do this, follow the procedure below.

1. Press the **SHOW List** key.

SHOW
List

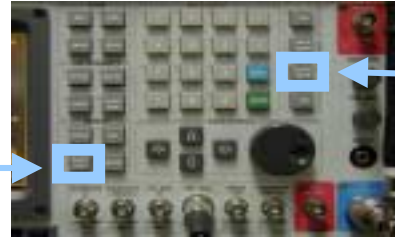

2. Press the F3 key "STORED FILES" to access the file directory.

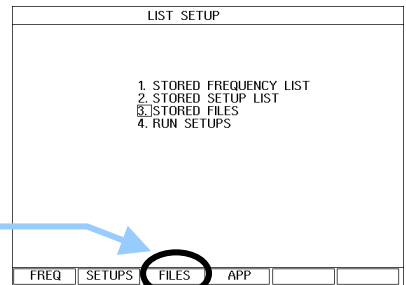

3. With the arrow keys, position the cursor to the filename SETUPS.APP and press the F1 key "OPEN".

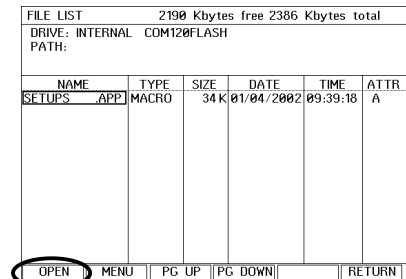

4. This has activated the COM-120B Test Functions Software.

5. Press **F6** "Exit" to exit the program. The program can be accessed in the future by pressing the **START STOP** key for quick access.

START
STOP

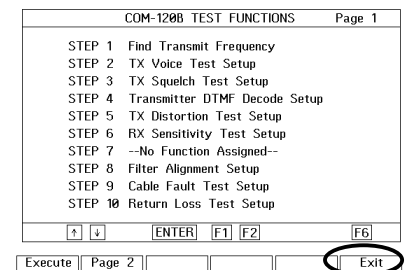

Note: This procedure must be performed only once after power up.



REC – Transmitter Test Screen

Exploded view of the function screens that are available in the REC screen.

The diagram shows the following sub-screens and their data:

- RECEIVE SCOPE (Top Left):** 20 kHz, 1 ms/div. Shows a complex waveform.
- SCOPE (Top Middle):** 1 MHz, 5 ms/div, 462.6525 MHz, RBW 300 kHz. Shows a single peak.
- RECEIVE AUDIO FREQUENCY COUNTER (Left):** 119.8 Hz, 200 Hz range.
- RECEIVE SCOPE (Center):** 1 kHz, 1 ms/div. Shows a sine wave. Parameters: RF: 151.6250 MHz, FL: OFF, Input: T/R Atten: 0 dB, Demod: FM IF BW: 15 kHz, AF GEN OUT: ON, LINE: MOD MTR, HPF: OFF, LPF: 20kHz, BPF: OFF, Tone/Data Code: DCS.
- RECEIVE (Bottom Center):** AF FREQUENCY: 1000 Hz, DISTORTION: 3.5%, RF ERROR: 0.024 kHz, RF POWER: 2.50 WATTS (33.9 dBm), DEVIATION: ± 3.02 kHz.
- RECEIVE SCOPE (Bottom Right):** 1 kHz, 1 ms/div. Shows a sine wave. Parameters: RF: 151.6250 MHz, FL: OFF, Input: T/R Atten: 0 dB, Demod: FM IF BW: 15 kHz, AF GEN OUT: ON, LINE: MOD MTR, HPF: OFF, LPF: 20kHz, BPF: OFF, Tone/Data Code: DCS.
- RECEIVE AUDIO FREQUENCY COUNTER (Bottom Left):** RF FREQUENCY ERROR: -0.033 kHz, F = 462.652467 MHz.
- RECEIVE RF POWER METER (Bottom Middle):** RF: 462.6525 MHz, Cable Loss: 0.4 dB, Power: 0.8 mW (-0.9 dBm).
- RECEIVE SCOPE (Bottom Right):** 1 kHz, 5 ms/div. Shows a sine wave. Parameters: RF: 462.6525 MHz, Sca/Demod Colo: DC, Range: AUTO, Peak Hold: OFF, Average: ON 2, Upper Limit: OFF, Lower Limit: OFF, Alarm: OFF, Mode: BOTH.

Source Information: Source: GEN1, State: ON, Format: TONE, Freq: 1000.0 Hz, Shape: SINE, Level: 20 mVP, 14.1 mVrms, Mode: CONT.

RECEIVER AUDIO/DATA FILTERS SETUP MENU:

| LINE | BAND FILTER | HIGH PASS FILTER | LOW PASS FILTER | MID-BAND |
|----------------|-------------|------------------|-----------------|----------|
| MOD METERS | OFF | OFF | 20kHz | OFF |
| DTMF/SINAD | C-MSG | OFF | OFF | OFF |
| AF CNTR/DECODE | OFF | OFF | 300Hz | OFF |
| DATA DECODER | OFF | OFF | 20kHz | OFF |

DTMF/SINAD CODES:

| | |
|----------------|--------------|
| 1. TONE | 10. CCIH |
| 2. TONE REMOTE | 11. CCIH4 |
| 3. USER | 12. NATEL |
| 4. EEA | 13. EURO |
| 5. EIA | 14. 5/6 TONE |
| 6. ZVEI | 15. USER |
| 7. DZVEI | 16. POCSAG |
| 8. DDZVEI | 17. POCSAG/ |
| 9. CCIH | 18. IMTS |

DTMF/SINAD CODES (Bottom Right):

| | |
|------------|-------------|
| 1. DTMF | 10. CCIH |
| 2. DCS | 11. CCIH4 |
| 3. DCS INV | 12. NATEL |
| 4. EEA | 13. EURO |
| 5. EIA | 14. 5/6 |
| 6. ZVEI | 15. USER |
| 7. DZVEI | 16. POCSAG |
| 8. DDZVEI | 17. POCSAG/ |
| 9. CCIH | 18. IMTS |



Transmitter Testing

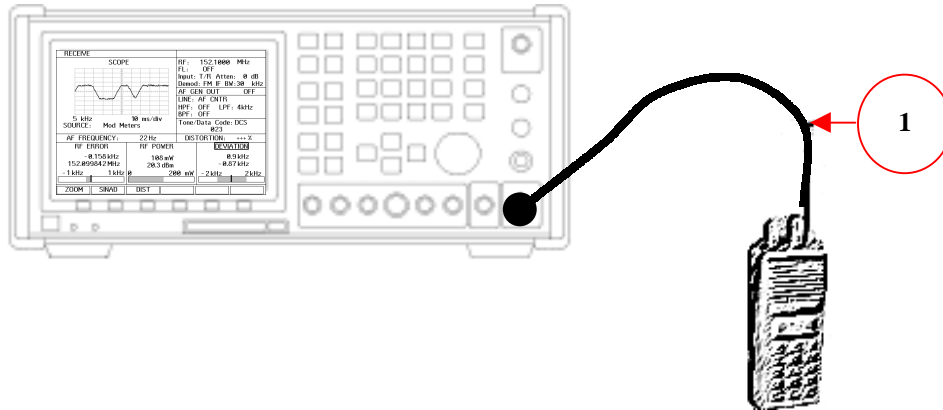

Interconnect:

1. Connect the supplied Transmitter RF Output to the COM-120B's **T/R** Input.
2. Turn the radio to the **ON** position and set to Channel **2**.
3. It is not necessary to connect any audio cables at this time.

The following procedures will lead through the process of:

- Finding an unknown transmitter frequency.
 - Frequency Tuning
- Voice Deviation Test
- Squelch test
 - CTCSS Tone
 - DCS Code
 - Squelch Tone Deviation
- DTMF Decode
- Transmit Audio Distortion



Find Transmit Frequency

Setup:

1. This COM-120B has been pre-configured for common transmitter test setups.

2. Press the **START STOP** key to access the COM-120B System Setup Utility software.

3. The menu to the right will appear.

4. Select **STEP 1** by positioning the cursor and pressing **F1 Execute**.

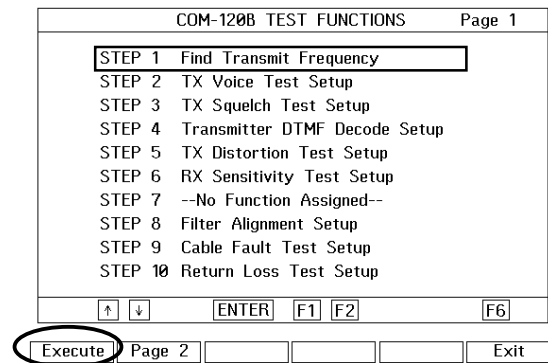

5. The COM-120B will now configure itself to find a transmitter frequency. The receive screen is selected and the COM-120B is monitoring the Power meter for the presence of RF Power.

6. Key the Transmitter and the COM-120B will switch screens to the stand alone spectrum analyzer to find the transmitter signal. Once the signal is found, the COM-120B will return to the Receive screen to allow evaluation of the transmitter. Keep the transmitter keyed until the COM-120B has completed this task. This procedure can be repeated if desired for a different radio channel.

7. This transmitter has been configured for a transmit frequency of 151.6250 MHz on channel 2. This should be the frequency that the COM-120B found.

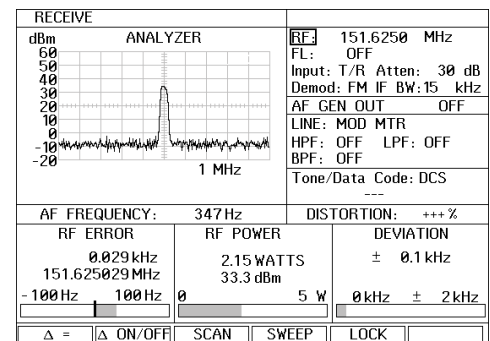



TX Frequency Tuning

Either the Scope or Spectrum Analyzer can be viewed by positioning the cursor to the **SCOPE** or **ANALYZER** field and selecting the desired display with the **F2** key.

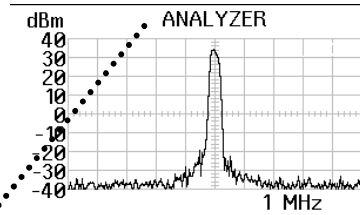

TX Frequency can be tuned by positioning the cursor to the **RF ERROR** label and pressing the **F1** key “**ZOOM**” to expand the meter to full screen mode.

(Remember the TAB key)

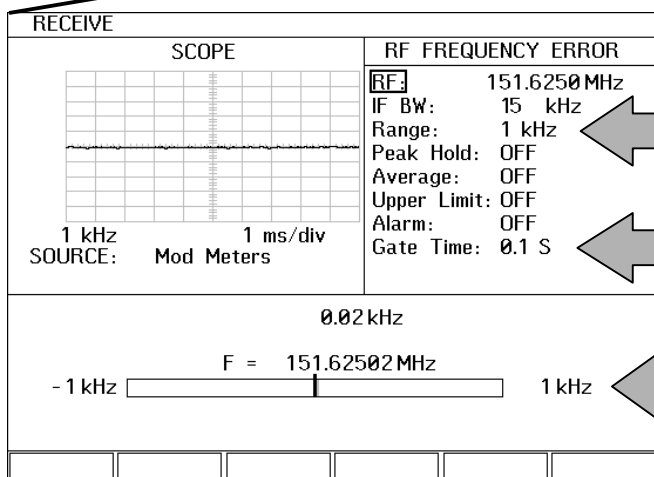
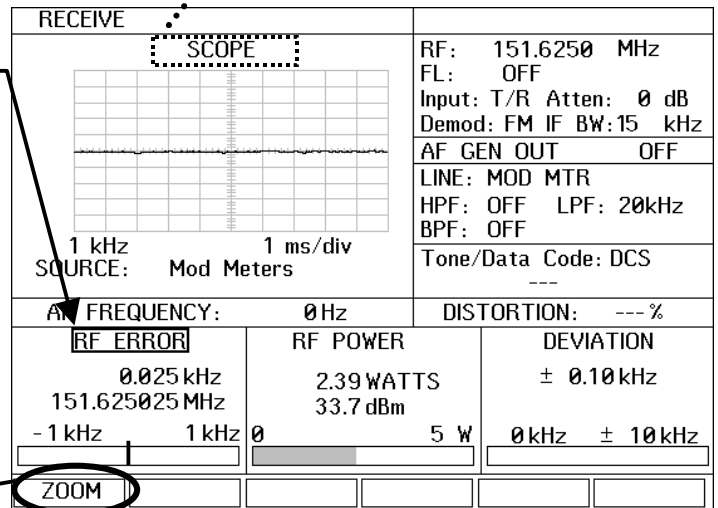

Frequency tuning can be easily done by setting the **Range** to a fixed range.

Set the **Gate time** to 0.1 S to take fast readings.

Use the bar graph meter to align transmitter frequency.

Note: Frequency tuning can be simulated by moving the cursor to the RF field and adjusting the last digit with the DATA SCROLL Knob.



Signal Find Feature

The Signal find feature is a function of the Spectrum Analyzer. To view the Spectrum Analyzer press the **ANLYZ** key on the front panel. Positioning the cursor to the RF Frequency field allows configuration of the signal find features. The entire RF spectrum or a small piece of the RF spectrum can be searched.

1) Set Frequency to 500 MHz

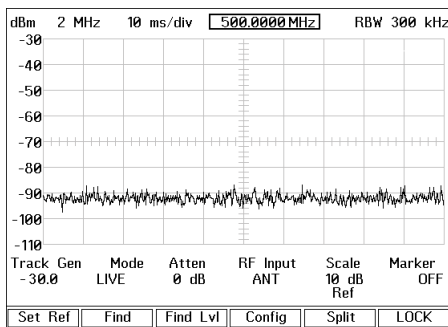

2) Set the Level Threshold

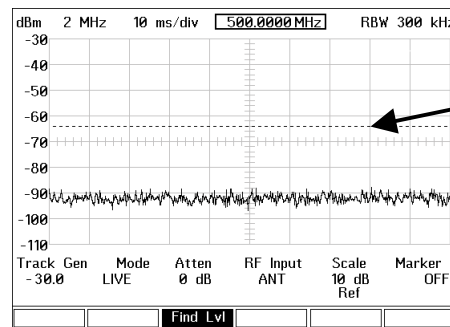

3) Set the Sweep Bandwidth

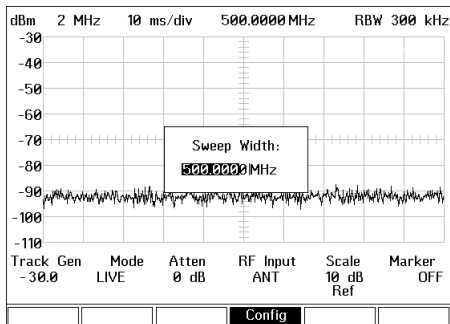

4) Activate Find

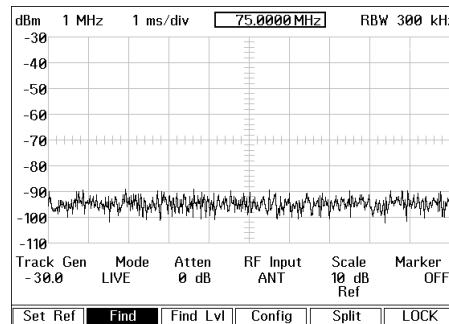

5) The Spectrum analyzer searches until a signal exceeds the threshold level.

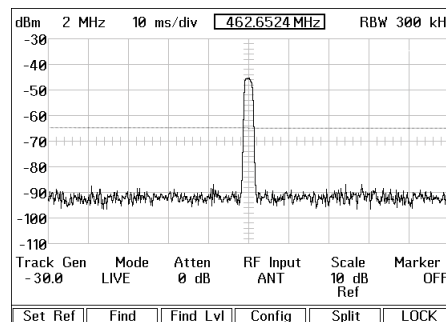



Test Voice Deviation

Setup:

1. This COM-120B has been pre-configured for common transmitter test setups.

2. Press the  key to access the COM-120B System Setup Utility software.

3. The menu to the right will appear.

4. Select **STEP 2** by positioning the cursor and pressing **F1 Execute**.

5. With the radio still configured to channel **2**, key the radio and whistle or speak into the radio's microphone.

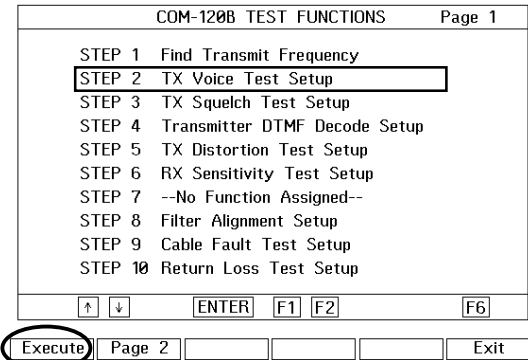

6. The voice deviation can be observed on the High Performance Scope as well as the Deviation meter. Additionally, the RF Power and Frequency can be evaluated.

7. Adjust the COM-120B's volume and squelch controls to hear the audio through the speaker when the transmitter is keyed.

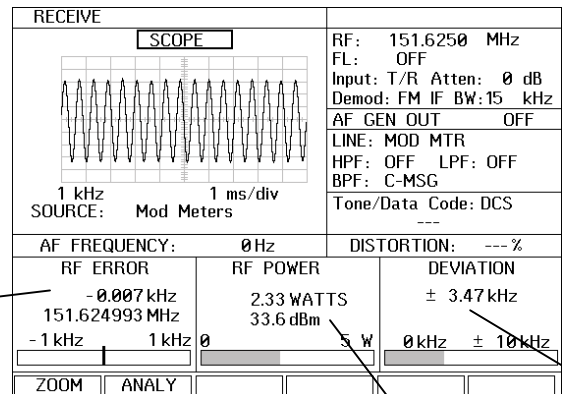

The frequency is displayed as both the frequency in MHz as well as the frequency error from the selected channel frequency.

Power is displayed in Watts and dBm. A compensation factor can be entered to correct the power meter reading to account for cable loss.

Deviation can also be measured as Peak+ and Peak-.



8. Position the cursor to the **Scope** Label by pressing **[TAB] [1] [ENTER]** on the COM-120B's keypad.
9. Press the **F1** key labeled "**ZOOM**" to expand the scope to a full sized scope.
10. With the Transmitter keyed, press the function keys that are labeled "**PK HOLD**" and "**MIN HOLD**". The scope display will now keep the maximum and minimum deviation extremes on the scope for evaluation of peak deviation.
11. Press the "**PK HOLD**" and "**MIN HOLD**" keys again to turn off the peak hold feature.

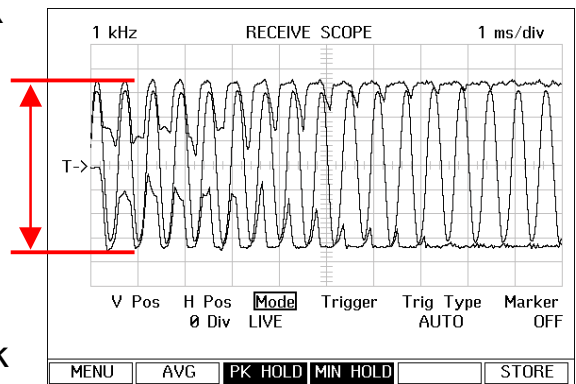
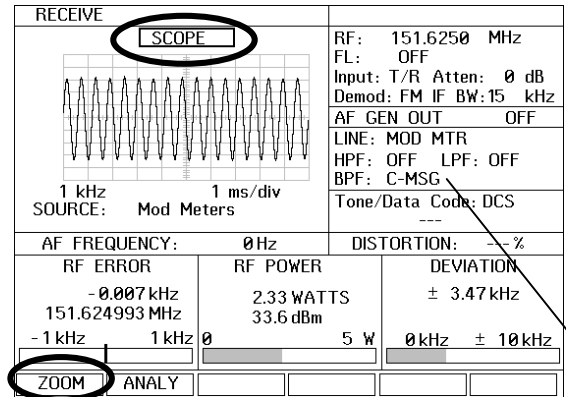

The Modulation meter has been configured for a CMSG filter for this test.



Test TX Squelch (CTCSS)

Setup:

1. This COM-120B has been pre-configured for common transmitter test setups.

2. Press the **START STOP** key to access the COM-120B System Setup Utility software.

3. The menu to the right will appear.

4. Select **STEP 3** by positioning the cursor and pressing **F1 Execute**.

5. The COM-120B will configure itself for testing Transmitter Squelch or SUB Audible deviation.

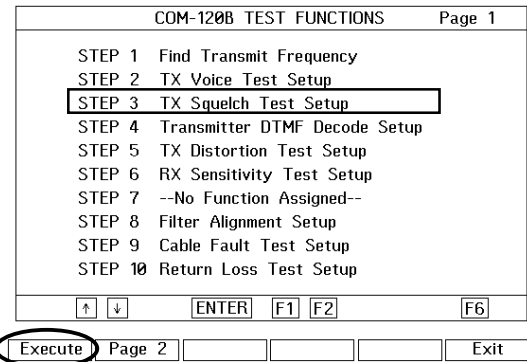

6. Configure the radio to channel **3**, key the radio and observe the CTCSS tone on the Scope and Deviation meter.

7. The CTCSS tone frequency is measured and displayed by the **AF FREQUENCY** counter.

8. To increase the resolution of the Audio Counter reading, zoom in reading by pressing **[TAB] [1] [4] [ENTER]** and press the **F1** key to zoom in on the Audio Counter.

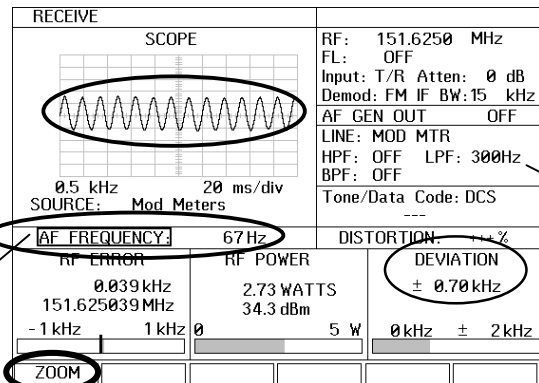
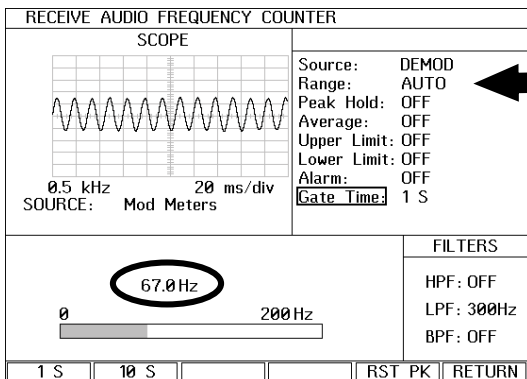

The AF Counter measures the CTCSS code to 1 Hz resolution. For greater resolution, this meter can be expanded.

The Modulation meter and Audio Frequency Counter have been configured for a 300 Hz Low Pass filter for this test.



Test TX Squelch (DCS)

Setup:

1. This COM-120B has been pre-configured for common transmitter test setups.

2. Press the  key to access the COM-120B System Setup Utility software.

3. The menu to the right will appear.

4. Select **STEP 3** by positioning the cursor and pressing **F1 Execute**.

5. The COM-120B will configure itself for testing Transmitter Squelch or SUB Audible deviation.

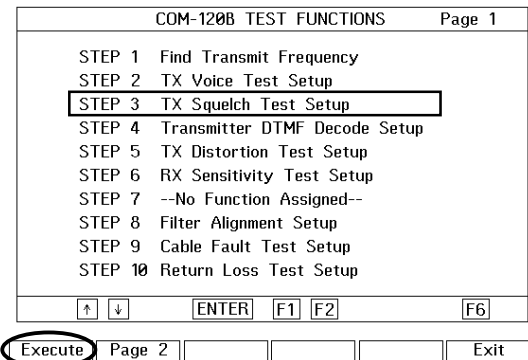

6. With the radio configured to channel 4, key the radio and observe the DCS signal on the Scope and on the Deviation meter.

7. The DCS code is decoded and displayed.

8. DCS deviation should be approximately 500 Hz or 0.5 kHz.

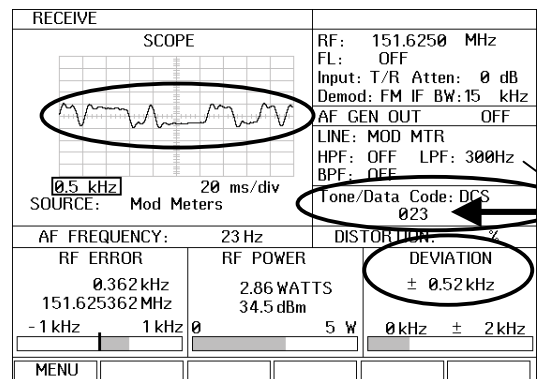

The Modulation meter and Data Decoder have been configured for a 300 Hz Low Pass filter for this test.



Test TX DTMF Decode

Setup:

1. This COM-120B has been pre-configured for common transmitter test setups.
2. Press the **START STOP** key to access the COM-120B System Setup Utility software.
3. The menu to the right will appear.
4. Select **STEP 4** by positioning the cursor and pressing **[F1] Execute**.
5. The COM-120B will configure itself for decoding Transmitter DTMF codes.

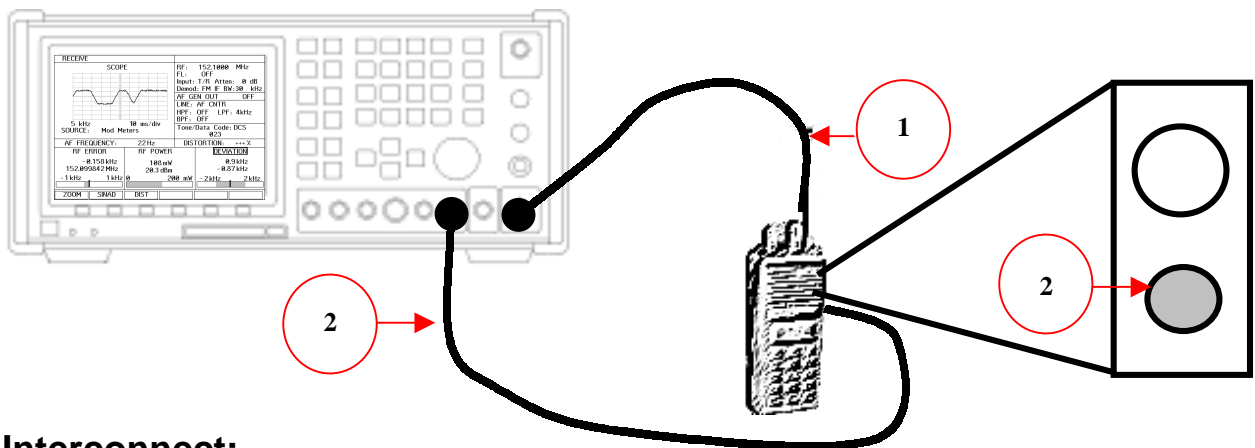
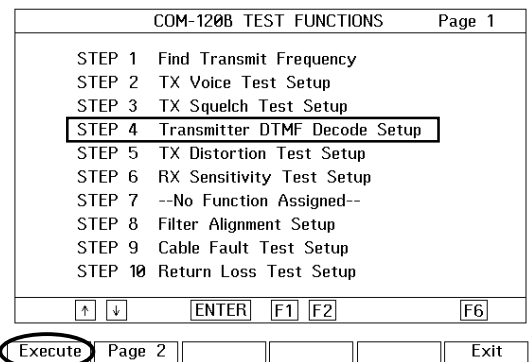

Interconnect:

1. Connect the Transmitter RF Output to the COM-120B's T/R Input.
2. Connect the COM-120B's **Audio/Data Gen Out** to the Radio's Microphone Input.



- The supplied transmitter does not have a DTMF keypad so the COM-120B's internal DTMF generator will be used to simulate pressing keys on a radio's DTMF keypad. The COM-120B's DTMF generator will externally modulate the transmitter and the COM-120B's receiver and DTMF decoder will decode the transmitted DTMF tone codes.
- Set the radio channel to **2** and Key the radio.

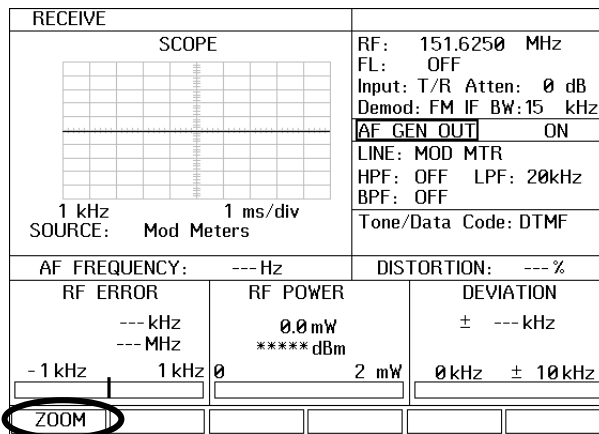

Source:DTMF State: ON
 Code:0123456789ABCD
 #*
 Mark: 70 msec
 Space: 70 msec
 Pause: 300 msec
 Level: 20 mVP
 Mode: CONT

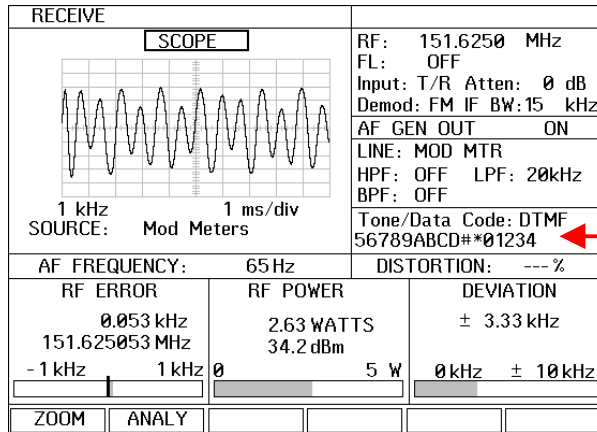

DTMF codes are decoded and displayed here.



Test TX Distortion

Setup:

1. This COM-120B has been pre-configured for common transmitter test setups.

2. Press the  key to access the COM-120B System Setup Utility software.

3. The menu to the right will appear.

4. Select **STEP 5** by positioning the cursor and pressing **F1 Execute**.

5. The COM-120B will configure itself for testing Transmitter Distortion.

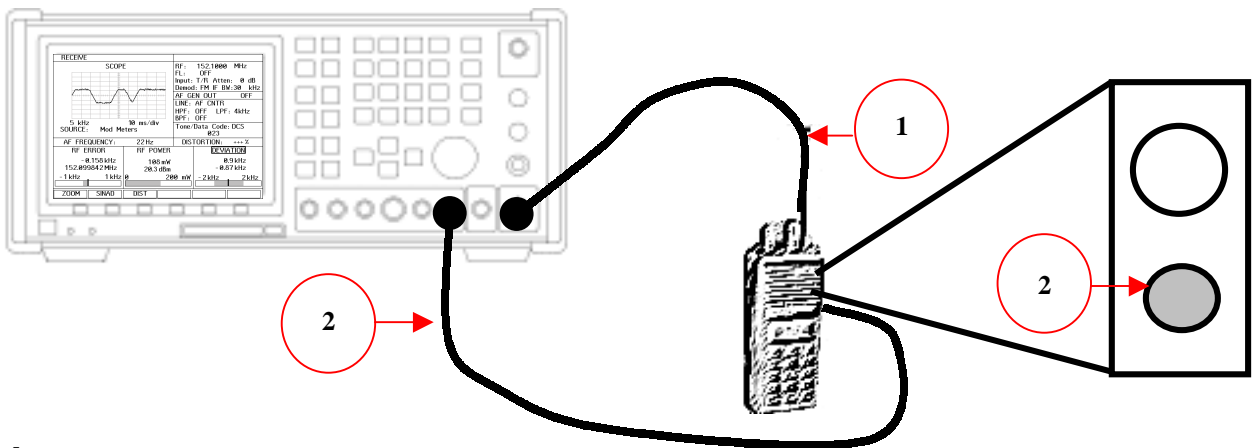
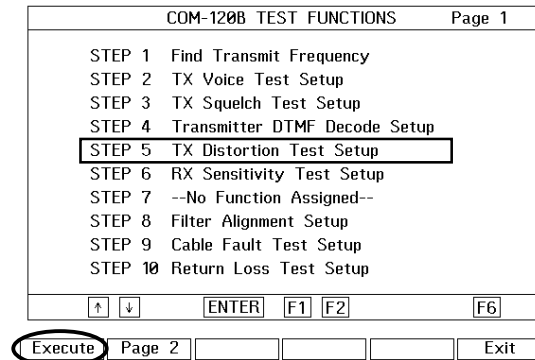

Interconnect:

1. Connect the Transmitter RF Output to the COM-120B's T/R Input.
2. Connect the COM-120B's Audio/Data Gen Out to the Radio's Microphone Input.



Measuring TX Distortion:

1. With the radio configured to channel 2, key the radio and observe a 1 kHz tone on the Scope at a level of 3 kHz deviation on the Deviation Meter.

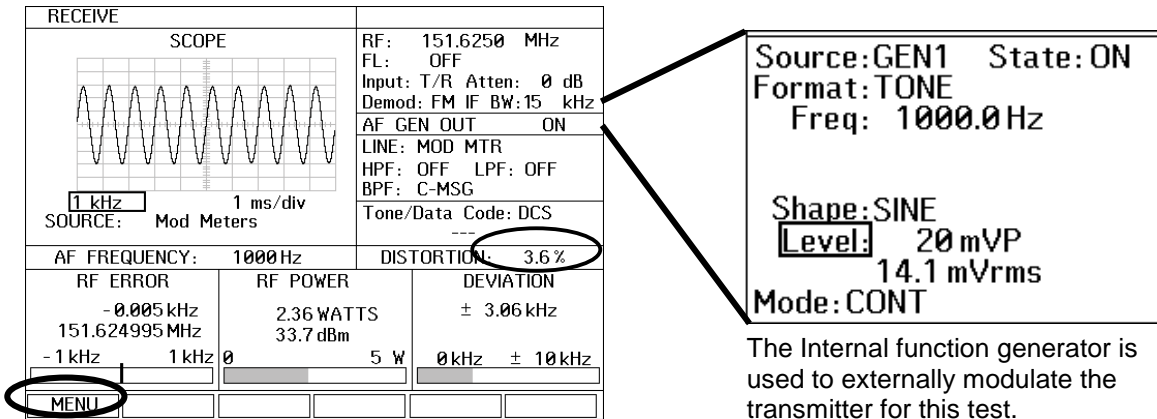

2. If necessary, position the cursor to the **AF GEN OUT** field, Press **F1** to **ZOOM** and adjust the audio injection level to achieve 3.0 kHz deviation.
3. The audio distortion is displayed in % and the indication should be less than 10%.

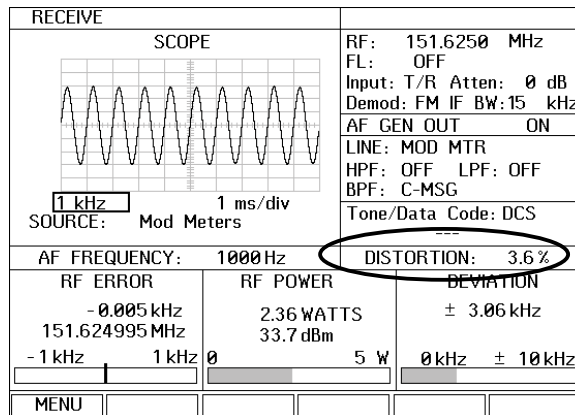



This concludes the Transmitter test section of this procedure. If you would like to try it out with one of your own radios, you may do so at this time. Use the software for setups as you did with our demonstration radio. Begin by using the Signal find feature to find your transmitter frequency and the rest of the setups will operate accordingly.

Once you have done this, continue on with the procedure to observe Receiver testing.



GEN – Receiver Test Screen

Exploded view of the function screens that are available in the **GEN** screen.



The generate screen provides all of the features that are required to provide stimulus to a receiver to evaluate performance characteristics.

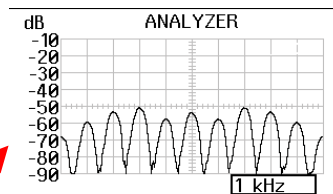

- 1. Scope/DVM - Gnd
- 2. Scope/DVM - AC
- 3. Scope/DVM - DC
- 4. Ext Mod
- 5. Int Mod
- 6. Audio/Data In
- 7. Notch Residual

GENERATE

SCOPE

1 V SOURCE: Audio/Data In 500 us/div

RF: 151.6250 MHz
FL: OFF
Level: -47.0 dBm
Output: T/R

GEN1

Mod Src: GEN1 FM
Deviation: 3.30 kHz
Format: TONE
Freq: 1000.0 Hz
Shape: SINE

AF LEVEL

2.00 Vrms

0 5.00 55 dB

SINAD

31.9 dB

0 dB

Audio/Data Filters

LINE: AF DEC
HP: OFF LP: OFF
BP: OFF

ZOOM DIST

- 1. TONE
- 2. TONE REMOTE
- 3. USER
- 4. EEA
- 5. EIA
- 6. ZVEI
- 7. DZVEI
- 8. DDZVEI
- 9. CCIR
- 10. CCIRH
- 11. CCIRH4
- 12. NATEL
- 13. EURO
- 14. 5/6 TONE
- 15. 10 PS
- 16. 20 PS
- 17. MTS
- 18. IMTS

GENERATE

SCOPE

1 V SOURCE: Audio/Data In 500 us/div

AUDIO FREQUENCY LEVEL

Source: AUDIO/DATA IN
Range: AUTO
Peak Hold: OFF
Average: OFF
Upper Limit: OFF
Lower Limit: OFF
Alarm: OFF

1.99 Vrms

0 5.00 V

Vrms dBm dB RETURN

GENERATE SINAD METER

SCOPE

1 V SOURCE: Audio/Data In 500 us/div

RF Level: -47.0 dBm
Range: AUTO
Peak Hold: OFF
Average: OFF
Upper Limit: OFF
Lower Limit: OFF
Alarm: OFF

31.9 dB

55 dB 0 dB

dBm uV mV V SINAD= S-On/Off

GENERATE DISTORTION METER

SCOPE

1 V SOURCE: Audio/Data In 500 us/div

RF Level: -47.0 dBm
Range: 20%
Peak Hold: OFF
Average: OFF
Upper Limit: OFF
Lower Limit: OFF
Alarm: OFF

2.5%

0 20%

20% 100% AUTO RST PK RETURN

| RF GENERATOR AUDIO/DATA FILTERS SETUP MENU | | | | |
|--|------------------|------------------|-----------------|-----------|
| LINE | BAND PASS FILTER | HIGH PASS FILTER | LOW PASS FILTER | WIDE-BAND |
| DTMF/SINAD | C-MSG | OFF | OFF | OFF |
| *** PRESS "EXEC" TO ACTIVATE SELECTION *** | | | | |
| SPEAKER/PHONES | W.B. | | | |
| OFF | C-MSG | | EXEC | RETURN |

The Audio Level meter can be configured to measure VRMS, dB or dBm.



GEN – Receiver Test Screen Modulation Sources

The COM-120B can be simultaneously modulated by up to 6 modulation sources. AM and FM can be mixed.

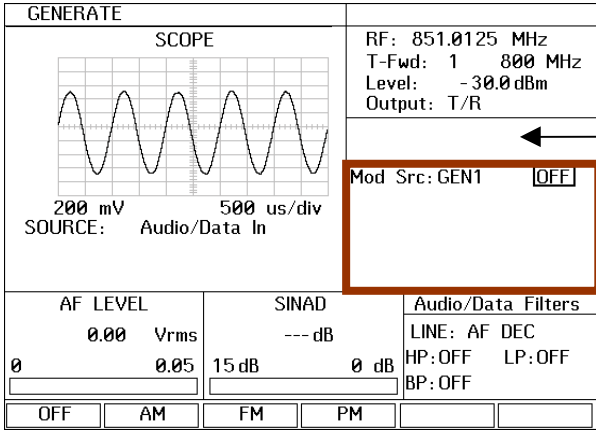

This area identifies what sources are turned on

GEN1 indicates that FGEN 1 is turned on

GEN1B indicates that FGEN1 is turned on but is in BURST mode

- | | |
|----------------|--------------|
| 1. TONE | 10. CCIRH |
| 2. TONE REMOTE | 11. CCIRH4 |
| 3. USER | 12. NATEL |
| 4. EEA | 13. EURO |
| 5. EIA | 14. 5/6 TONE |
| 6. ZVEI | 15. 10 PS |
| 7. DZVEI | 16. 20 PS |
| 8. DDZVEI | 17. MTS |
| 9. CCIR | 18. IMTS |

The Gen 1 Source field can be configured for a standard 1 kHz tone or a tone format.

Mod Src: GEN1 FM
 Deviation: 5.00 kHz
 Format: TONE
 Freq: 1000.0 Hz
 Shape: SINE

Mod Src: GEN2 FM
 Deviation: 5.0 kHz
 Format: TONE
 Freq: 1000.0 Hz
 Shape: SINE

The Gen 2 Source field can be configured for a CTCSS Tone OR

Mod Src: DTMF FM
 Deviation: 1.00 kHz
 Code: 0123456789ABCD##*
 Mark: 70 msec
 Space: 70 msec
 Pause: 300 msec

Mod Src: DATA FM
 Deviation: 1.0 kHz
 Format: DCS
 Code: 023

The DATA generator could be used to configure a DCS code for digital squelch systems.

Mod Src: MIC FM
 Dev Range: WIDE

Mod Src: EXT FM
 Dev Range: WIDE



Receiver Testing

Setup:

1. This COM-120B has been pre-configured for common receiver test setups.

2. Press the **START STOP** key to access the COM-120B System Setup Utility software.

3. The menu to the right will appear.

4. Select **STEP 6** by positioning the cursor and pressing **F1 Execute**.

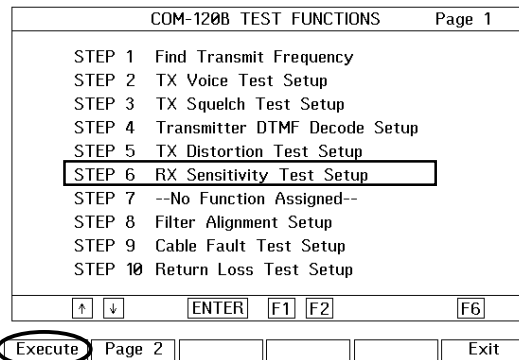

5. The COM-120B will configure itself for testing Receiver Sensitivity.

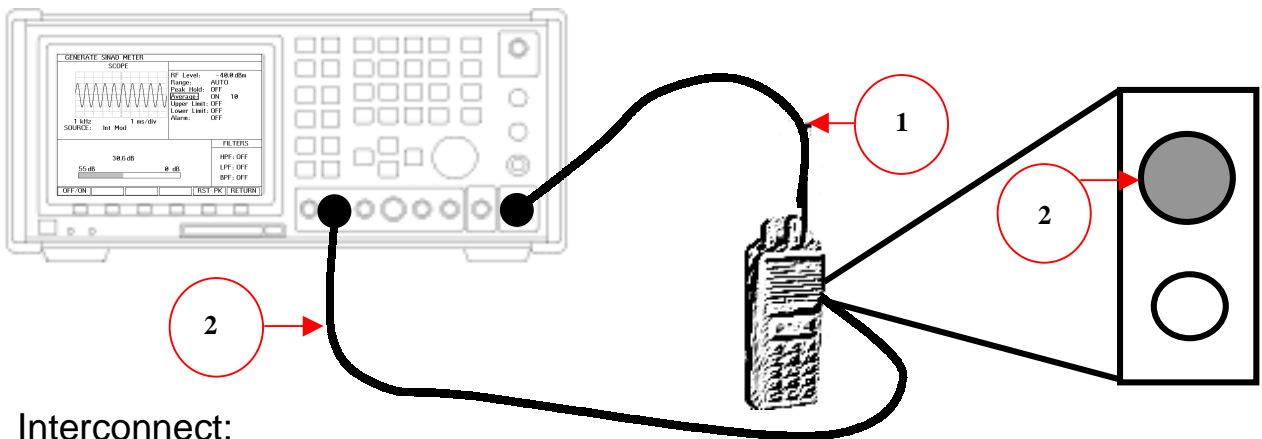

Interconnect:

1. Connect the COM-120B's T/R port (Generator Output) to the Antenna Input of the Radio under test.
2. Connect the radio's Audio Output to the COM-120B's SINAD Input.
3. With the radio configured to channel **2**, adjust the radio's volume control for a 2 Vrms indication on the COM-120B's **AF LEVEL** meter as shown on the next page.



The COM-120B has been configured with the **AUDIO/DATA Input** routed to the scope to view the radio's demod output. This is the same signal that the SINAD meter will evaluate.

The COM-120B injects a carrier modulated with a 1 kHz tone at 3.3 kHz deviation into the radio's receiver.

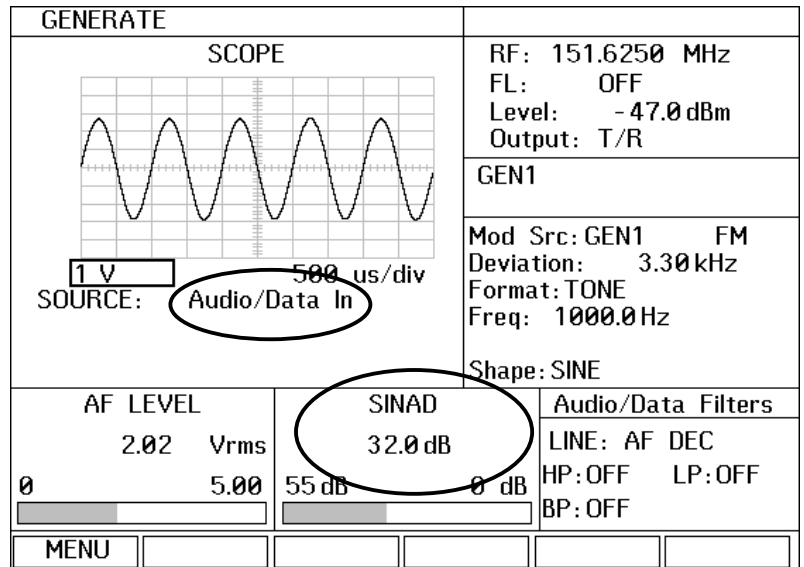

4. Position the cursor to the **Level** field. [TAB] [4] [ENTER]

5. Press the [ENTER] key to highlight the RF Level value and adjust with the Knob control to reduce the level until the COM-120B's SINAD meter indicates approximately 12 dB. Note: The monitor button on the radio may need to be held down to defeat the radio's squelch operation.

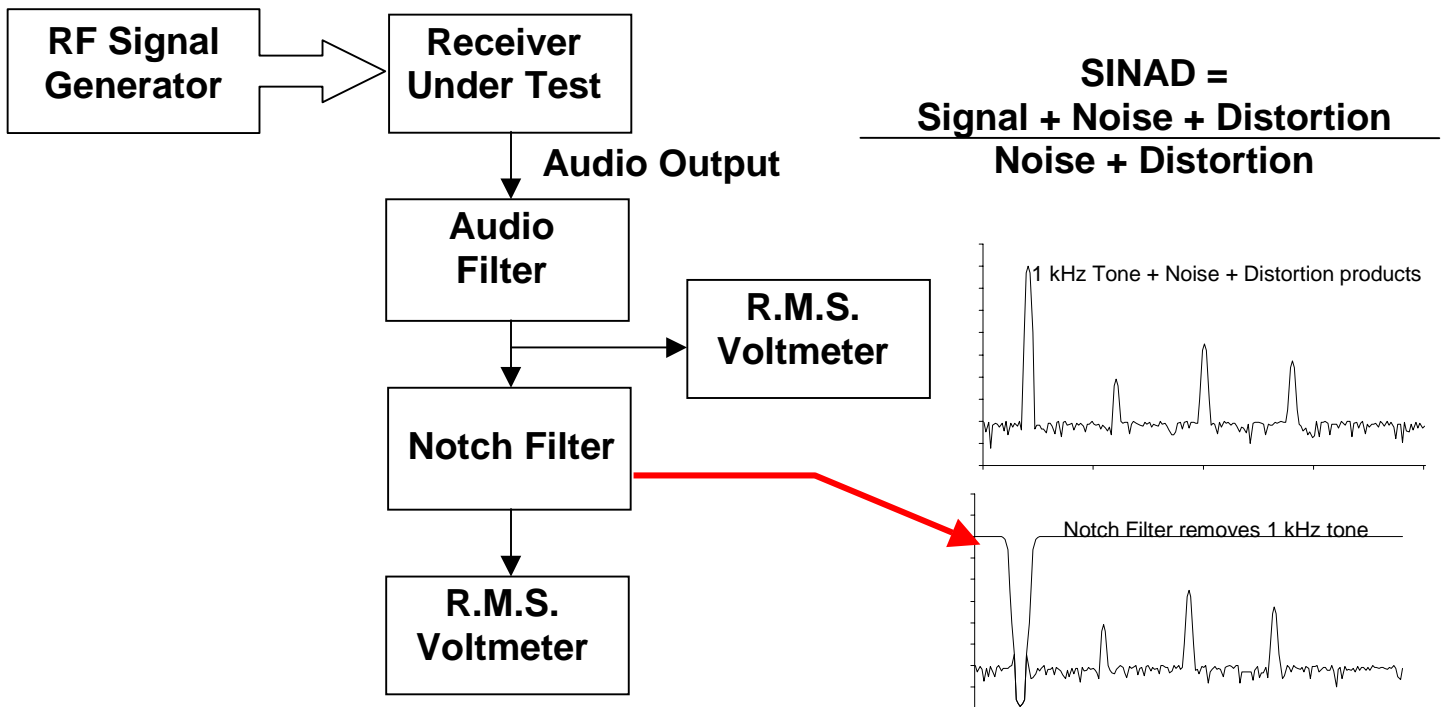



The SINAD meter can be expanded to allow more control by positioning the cursor to the SINAD meter label [TAB] [1] [6] [ENTER] and pressing the F1 key “ZOOM”

| | | | | | |
|-------|-----------------------|--|-----------------|--|---------------------|
| TAB | GENERATE | | SCOPE | | RF: 462.6525 MHz |
| 1 | SCOPE | | 500 mV 1 ms/div | | FL: 0 TALK1 |
| 6 | SOURCE: Audio/Data In | | SINAD | | Level: -93.0 dBm |
| ENTER | AF LEVEL | | 13.4 dB | | Output: T/R |
| ZOOM | 0 1.00 | | 55 dB 0 dB | | GEN1 |
| | ZOOM | | DIST | | Mod Src: GEN1 FM |
| | | | | | Deviation: 2.40 kHz |
| | | | | | Format: TONE |
| | | | | | Freq: 1000.0 Hz |
| | | | | | Shape: SINE |
| | | | | | Audio/Data Filters |
| | | | | | LINE: AF DEC |
| | | | | | HP: OFF LP: OFF |
| | | | | | BP: C-MSG |

| | |
|-----------------------|---------------------|
| GENERATE SINAD METER | |
| SCOPE | RF Level: -93.0 dBm |
| 500 mV 1 ms/div | Range: 55 dB |
| SOURCE: Audio/Data In | Peak Hold: OFF |
| | Average: ON 10 |
| | Upper Limit: OFF |
| | Lower Limit: OFF |
| | Alarm: OFF |
| 14.2 dB | FILTERS |
| 55 dB 0 dB | HPF: OFF |
| | LPF: OFF |
| | BP: C-MSG |
| dBm uV mV V | SINAD= S=On/Off |

- Ensure the C-MSG Filter is enabled
- Enable SINAD Average to 10 for manual measurements or turn Averaging OFF for Automatic measurements.
- Move Cursor to RF LEVEL (TAB, 2, ENTER)
- Select SINAD = and set the desired SINAD point, (12 or 20 dB typical)
- Activate Auto SINAD S = On/OFF
- STAND BACK AND WATCH

Scope source can be set to view Internal Modulation source, Audio/Data Input port or Notch Residual to evaluate receiver performance.

Note: Averaging should be turned off when performing automatic SINAD search operations.



DUPLEX Operation Mode

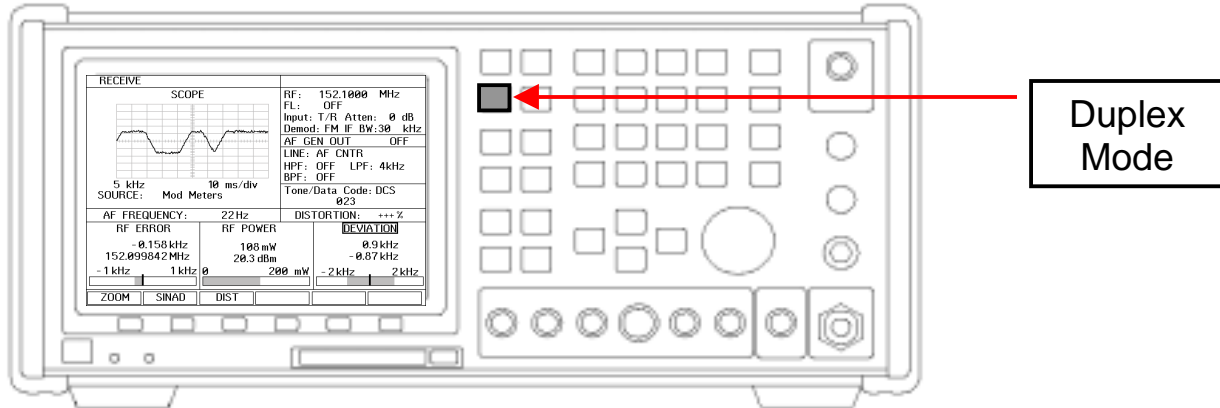

| DUPLEX RECEIVE AND GENERATE | |
|-----------------------------|--------------------|
| RECEIVE | GENERATE |
| RF: 462.6525 MHz | RF: 462.6525 MHz |
| FL: 0 TALK 1 | Offset: 0.0000 MHz |
| Input: ANT Atten: 0 dB | Level: -40.0 dBm |
| Demod: FM IF BW: 15 kHz | Output: T/R |
| Tone/Data Code: DCS | |
| --- | |
| Deviation: 0.20 kHz | Mod Src: GEN1 OFF |
| AF Frequency: 120 Hz | |
| Distortion: +++% | |
| RF Level: -50.0 dBm | |
| RF Error Freq: -0.036 kHz | |
| ZOOM | |

| DUPLEX RECEIVE ANALYZER | |
|--|--|
| | RF: 462.6525 MHz FL: 0 TALK 1 Input: ANT Atten: 0 dB Demod: FM IF BW: 15 kHz AF GEN OUT OFF LINE: MOD MTR HPF: OFF LPF: 300 Hz BPF: OFF Tone/Data Code: DCS --- |
| AF FREQUENCY: 0 Hz | DISTORTION: +++% |
| RF ERROR -0.036 kHz 462.652464 MHz -100 Hz 100 Hz | REC LEVEL -50.0 dBm 707.1 uV -110 dBm -30 dBm |
| DEVIATION | |
| 0.1 kHz -0.25 kHz -2 kHz 2 kHz | |
| ZOOM | SINAD |
| DIST | |

| DUPLEX GENERATE ANALYZER | |
|--------------------------|--|
| | RF: 462.6525 MHz FL: 0 TALK 1 Level: -40.0 dBm Output: T/R Mod Src: GEN1 OFF |
| AF LEVEL 0.00 Vrms | SINAD --- dB |
| 0 0.05 | 55 dB 0 dB |
| Audio/Data Filters | |
| LINE: AF DEC | |
| HP: OFF LP: OFF | |
| BP: OFF | |
| Δ = | Δ On/Off |
| SET REF | PAIR |

Simultaneous Generate and Receive operation for Full Duplex
Any Offset between Generate and Receive frequencies in 2.5 kHz steps



The Duplex screen offers the ability to generate and receive at the same time. Additionally, the Generate and Receive frequencies may be set to any frequency within the limitation of either the Receiver or the Generator. The Receiver could be set to 10.7 MHz or 455 kHz while the Generator is set to 151.625 MHz allowing signal tracing through IF strips. This feature allows the spectrum analyzer to be used for signal tracing while the RF Signal generator is being used to stimulate the Receiver at the channel frequency. The Duplex screen is also commonly used to test cross-band repeaters. The generator could be used in the VHF band while the receiver is operating in the UHF band.

The DUPLEX screen allows control of primary features of the RF Generator and the Receiver. The more comprehensive stand-alone Receive or Generate screens can be selected by positioning the cursor to the respective field and pressing the **F1** key to **ZOOM**. Zooming in on the RECEIVE function allows access to the Spectrum Analyzer in the Receive screen while leaving the generator operational.

| DUPLEX | | RECEIVE AND GENERATE | |
|---------------------|------------------|----------------------|--------------|
| RECEIVE | | GENERATE | |
| RF: | 462.6525 MHz | RF: | 462.6525 MHz |
| FL: | 0 TALK 1 | Offset: | 0.0000 MHz |
| Input: | ANT Atten: 0 dB | Level: | -40.0 dBm |
| Demod: | FM IF BW: 15 kHz | Output: | T/R |
| Tone/Data Code: DCS | | | |
| --- | | Mod Src: GEN1 OFF | |
| Deviation: | 0.20 kHz | | |
| AF Frequency: | 120 Hz | | |
| Distortion: | +++% | | |
| RF Level: | -50.0 dBm | | |
| RF Error Freq: | -0.036 kHz | | |
| ZOOM | | | |



This concludes the Receiver test procedure. There are other tests that can be performed on the receiver but are beyond the scope of this guide at this time.

Please turn the radio power to the OFF position now and return it to the evaluation kit.



Spectrum Analyzer

Measuring Filters

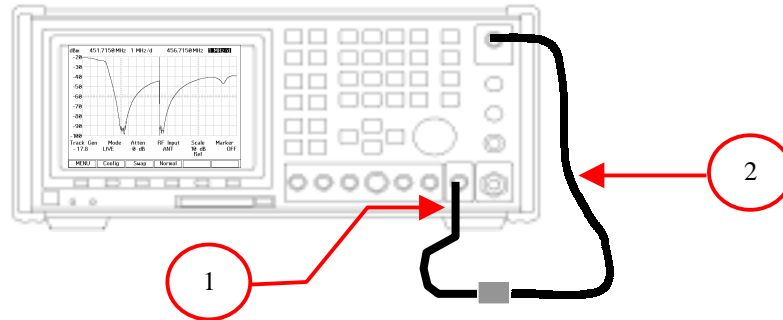

Interconnect:

1. Connect an RF cable to the COM-120B's AUX RF Output.
2. Connect an RF cable to the COM-120B's Antenna Input.
3. Using a BNC Barrel, connect the two RF cables together forming a loop with two cables from the AUX RF Output to the Antenna Input of the COM-120B. This will configure the COM-120B to zero out test cables for making insertion loss measurements.

Setup:

1. This COM-120B has been pre-configured for common Analyzer test setups.
2. Press the **START STOP** key to access the COM-120B System Setup Utility software.
3. The menu to the right will appear.
4. Select **STEP 8** by positioning the cursor and pressing **F1 Execute**.
5. The COM-120B will configure itself for filter measurements.

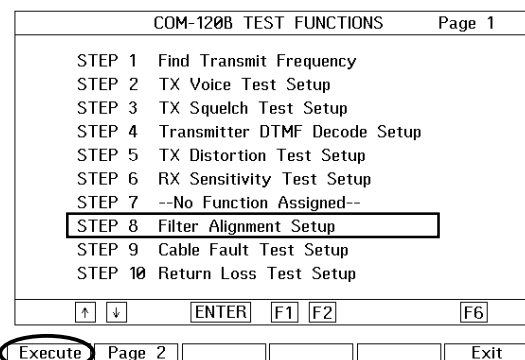



The Tracking Generator function allows analysis of:

- Filter Insertion Loss
- Filter Notch Depth
- Filter Pass band
- Filter Bandwidth

The current hookup and COM-120B configuration is as follows:

The Tracking generator (AUX RF OUT) is connected to the Antenna port therefore the output is looped back around to the input. This is done so we may now be able to adjust the Tracking generator Output level for a 0 reference on the spectrum analyzer display. This must be done to accurately measure insertion loss.

To do this, position the cursor to the Track Gen field and press the ENTER key to highlight the value. Use the left and right arrow keys to select either the 1 or .1 db digits and then use the Data Scroll Knob to adjust the Tracking Generator level for a 0 dBm reference on the Spectrum Analyzer display. NOTE: The Tracking generator level will probably not indicate 0 dBm and it is not necessary for it to be 0 dBm.

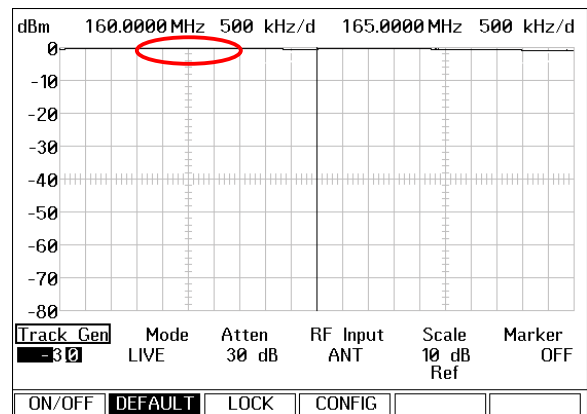

After the reference level has been established we will connect the provided duplexer to evaluate the above mentioned measurements. Note: The COM-120B has been placed into a unique Split screen mode of operation for the comprehensive evaluation of this filter. In Split screen mode, the COM-120B is essentially operating as **two** separate spectrum analyzers allowing one setup to view both the pass band and the reject band simultaneously.

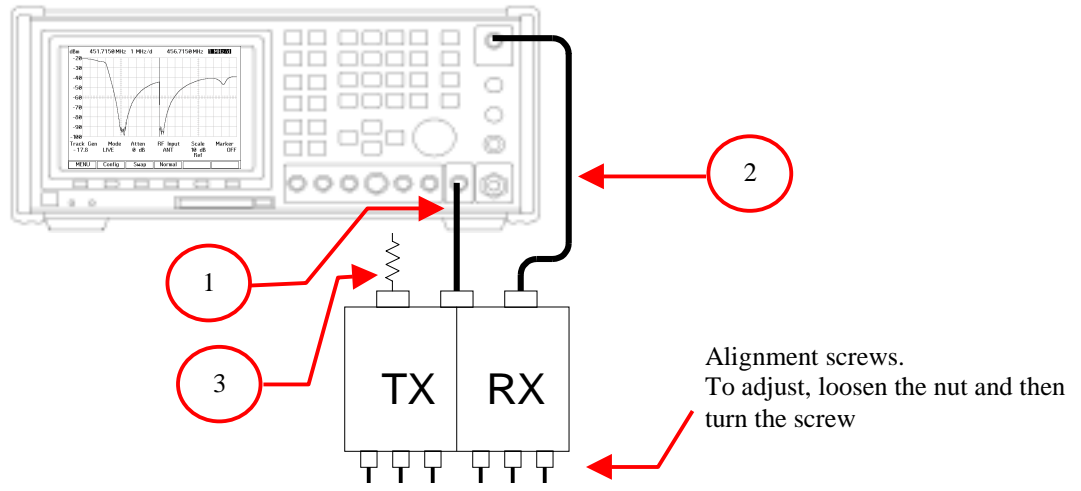

1. Connect the Duplexer Antenna port to the COM-120B's AUX RF Output.
2. Connect the Duplexer 160 MHz port to the COM-120B's Antenna port.
3. Connect a 50-ohm Termination to the remaining port.

If the filter is properly aligned, the image to the right will be displayed. The left side shows the pass band while the right side shows the reject band. With the current setup, examine the left side for insertion loss. This can be measured from the top line to where the trace is on the display. The object is to have minimum insertion loss here.

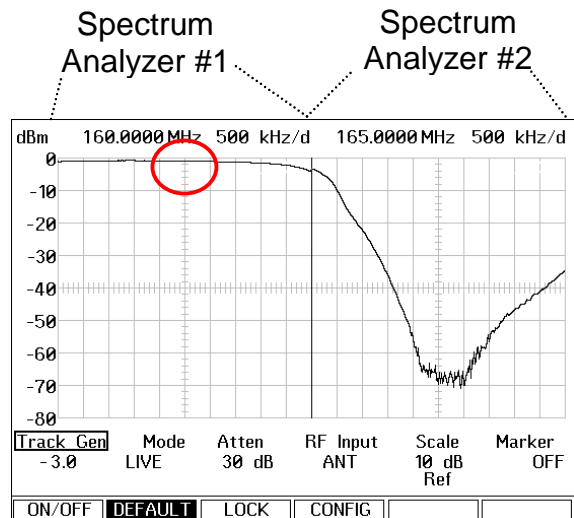



Position the cursor to the Atten field and select **0 dB** input attenuation by pressing the **F2** key. The right side may now be evaluated for the reject band. This image indicates that the filter has a notch depth of 100 dB because we had started with a reference trace set for a 0 dB indication. The SCAN width on spectrum analyzer #2 can be adjusted down to 100 kHz to allow more finite tuning of frequency. Toggling the input attenuation between 0 and 30 dB while tuning allows monitoring of both the reject notch depth and the pass band insertion loss.

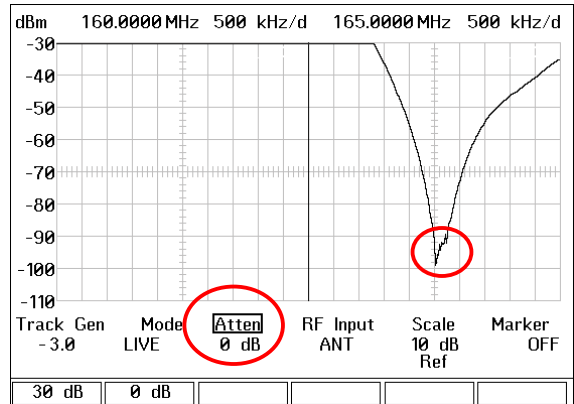

Swap the Cable and load between the 160 MHz and the 165 MHz ports on the duplexer to view the characteristics of the other filter in the duplexer. The image to the right indicates that this filter also has a 100 dB notch depth.

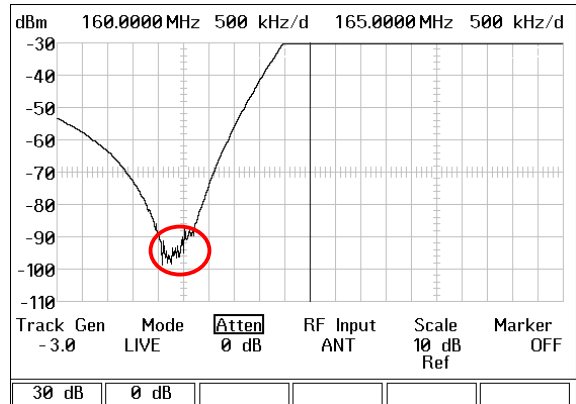

Additional range can be obtained by reducing the Resolution Bandwidth and slowing the sweep

Set the Input Attenuation back to 30 dB now to evaluate the insertion loss of this side of the filter.

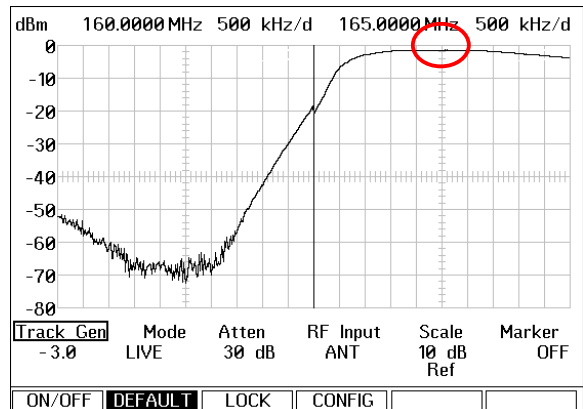



Measuring Cable Fault

Setup:

1. This COM-120B has been pre-configured for common Analyzer test setups.

2. Press the  key to access the COM-120B System Setup Utility software.

3. The menu to the right will appear.

4. Select **STEP 9** by positioning the cursor and pressing **F1 Execute**.

Note: This item offers a help screen accessible by pressing the F3 key.

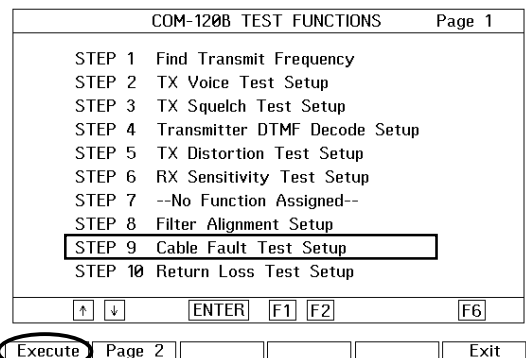

5. The COM-120B will configure itself for testing Cable Fault measurement.

Interconnect:

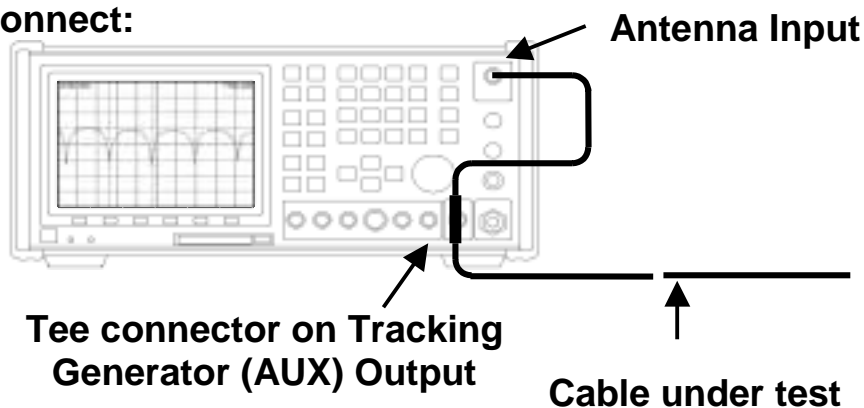

6. Establish the cable interconnect as shown above.



1. Position the cursor to the Marker field label.
2. Press the F1 key to activate marker.
3. Press the ENTER key to edit the Marker Frequency.
4. Use the arrow keys to highlight the 1 MHz digit and then the Data Scroll knob to adjust the frequency value until the marker is placed directly on the minimum point of the first dip.
5. Record the marker frequency as F1.
6. Position the marker to the second dip and record the frequency as F2.
7. Calculate the difference (F2 – F1)

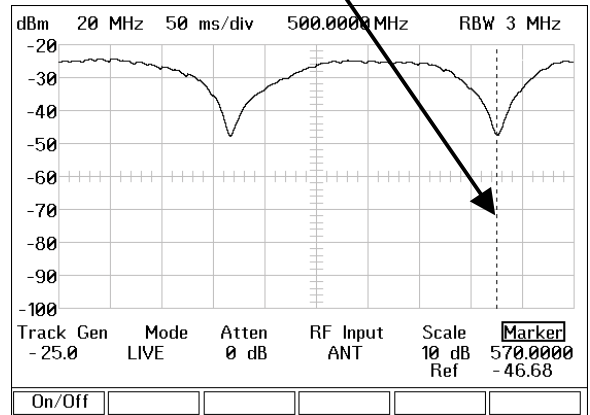
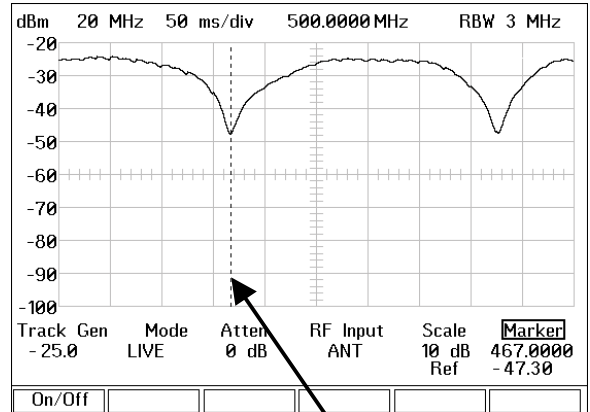

To calculate the cable length, measure the frequency difference in MHz between two adjacent nulls. By factoring in the velocity factor of the cable type, the length can be calculated with the following formula.

$$\text{Distance feet} = \frac{492 * \text{Velocity Factor}}{\text{Delta Freq. in MHz}} \quad 3.148\text{ft} = \frac{492 * 0.659}{570.0 - 467.0}$$

The velocity factor for RG-58 is 65.9% or 0.659.



Measuring Return Loss

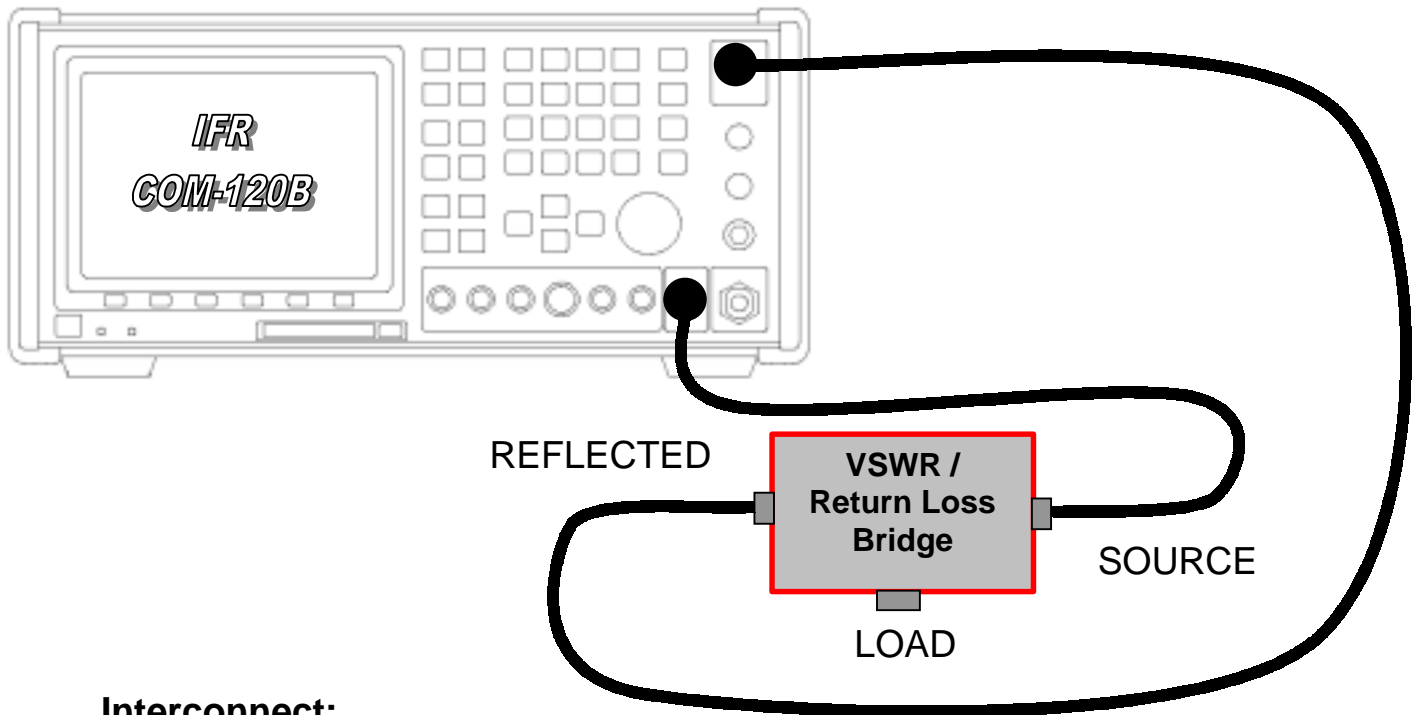

Interconnect:

1. Connect the Return Loss Bridge as indicated in the graphic above.
2. Connect the Bridge Source Port to the COM-120B's AUX RF Output.
3. Connect the Bridge Reflected Port to the COM-120B's Antenna port.

Setup:

1. This COM-120B has been pre-configured for common Analyzer test setups.
2. Press the  key to access the COM-120B System Setup Utility software.



3. The menu to the right will appear.
4. Select STEP 10 by positioning the cursor and pressing F1 Execute.
5. The COM-120B will configure itself for testing Return Loss.

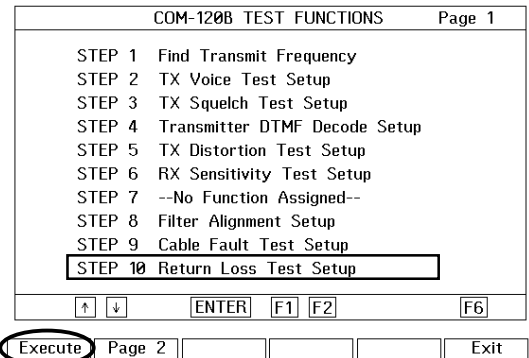

6. Connect the Load port of the Return Loss bridge to the 160 MHz port of the Duplexer Filter.
7. Connect 50-ohm terminations to the remaining ports on the duplexer.
8. The resulting return loss for the 160 MHz port of the duplexer is displayed in dB. In this case, the indicated Return Loss is approximately 31 dB.

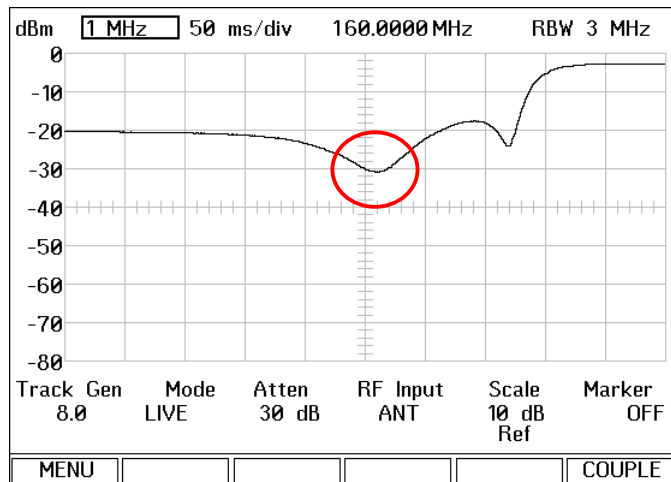
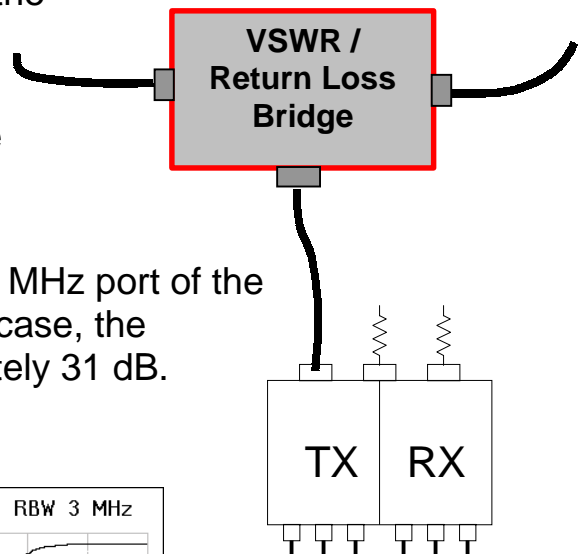



This concludes the COM-120B Evaluation procedure. If you would like information or assistance with tests not covered by this procedure, please contact our technical staff for assistance at 1-800-835-2352 and select menu item 1. You will be able to speak to a trained specialist who is well versed with this product.



Standard Features

- **RF Signal Generator**
 - **Output Level +13 to -130**
- **0.2 PPM TCXO**
- **2 uV Receiver with 15, 30 and 300 kHz IF filters**
- **50 kHz Scope**
- **Full band / Dual Mode Spectrum Analyzer**
- **Digital Voltmeter**
- **Audio Level Meter**
- **Dual Audio Function Generators**
- **Data Generator DCS, DCS INV**
- **DTMF Generator**
- **Encode / Decode**
 - **DCS, DTMF, CTCSS**
- **RF Frequency Error Meter and Counter**
- **FM Deviation Meter**
- **AM Modulation Meter**
- **Phase Modulation Meter**
- **Audio Frequency Counter**
- **RF Power Meter (2 mW - 200 W)**
 - **50 W Continuous**
- **RF Level Meter**
- **Distortion Meter**
- **SINAD Meter (With auto-search)**
- **RS-232**



Optional Features

- **0.01 PPM OCXO (120B-xTx)**
- **Internal Rechargeable Battery (AC3001)**
- **Tracking Generator (AC3012)**
- **Return Loss Bridge (AC4105)**
- **EasySweep Software (AC1019)**
- **EasySpan for Windows (AC1009W)**
- **Digital / Analog Signaling (AC3011)**
 - **CCIR, CCIRH, CCIRH4, EEA,**
 - **EIA, NATEL, ZVEI, DZVEI,**
 - **DDZVEI, EURO, 5/6 Tone, POCSAG**
- **RCC Signaling (AC3009)**
 - **Tone Remote, IMTS, MTS, 10 PS, 20 PS**
- **Data Generator / BER Meter (AC3007)**
- **MPT-1327 Trunking (AC9161)**
- **Clear Channel LTR Trunking (AC3014)**
- **EDACS Trunking (AC3016)**
- **7.5 kHz IF Filter (AC9162)**
- **SSB Filter (120B-8xx)**
- **Microphone (AC8645)**
- **Antenna (AC1201)**
- **Heavy Duty Ship case (AC8753)**
- **Soft Padded carry case (AC9925)**
- **IEEE-488 Interface (AC3013)**
- **EasyCom Land Mobile test software (AC1022)**
- **Application Library (AC1023)**
- **Nortel Cellular Base Station Software (AC1037)**
- **Programming Manual (AC0301)**
- **Maintenance Manual (AC0600)**
- **Extended Warranty 3/5 year**