



INSTRUCTION MANUAL

VHF AIR BAND TRANSCEIVERS

IC-A220 IC-A220E



This device complies with Part 15 of the FCC Rules. Operation is subject to the condition that this device does not cause harmful interference.

Icom Inc.

IMPORTANT

READ ALL INSTRUCTIONS carefully and completely before using the transceiver.

SAVE THIS INSTRUCTION MANUAL — This instruction manual contains important operating instructions for the IC-A220 and IC-A220E.

EXPLICIT DEFINITIONS

The explicit definitions below apply to this instruction manual.

WORD	DEFINITION
⚠ WARNING!	Personal injury, fire hazard or electric shock may occur.
CAUTION	Equipment damage may occur.
NOTE	If disregarded, inconvenience only. No risk of personal injury, fire or electric shock.

CAUTION: Changes or modifications to this transceiver, not expressly approved by Icom Inc., could void your authority to operate this transceiver under FCC regulations.

Icom, Icom Inc. and Icom logo are registered trademarks of Icom Incorporated (Japan) in Japan, the United States, the United Kingdom, Germany, France, Spain, Russia, Australia, New Zealand, and/or other countries.

FCC INFORMATION

• **FOR CLASS A UNINTENTIONAL RADIATORS:**

This equipment has been tested and found to comply with the limits for a Class A digital device, pursuant to part 15 of the FCC Rules. These limits are designed to provide reasonable protection against harmful interference when the equipment is operated in a commercial environment. This equipment generates, uses and can radiate radio frequency energy and, if not installed and used in accordance with the instruction manual, may cause harmful interference to radio communications. Operation of this equipment in a residential area is likely to cause harmful interference in which case the user will be required to correct the interference at his own expense.

• **POUR LES RAYONNEMENTS NON INTENTIONNELS DE CLASSE A:**

Cet équipement a été testé et reconnu conforme aux limites fixées pour un appareil numérique de classe A, conformément au point 15 de la réglementation FCC. Ces limites sont définies de façon à fournir une protection raisonnable contre le brouillage préjudiciable lorsque cet appareil est utilisé dans un environnement commercial. Cet équipement génère, utilise et peut émettre un rayonnement de fréquence radio. S'il n'a pas été installé conformément aux instructions, il peut par ailleurs créer des interférences perturbant les communications radio.

L'utilisation de cet appareil dans une zone résidentielle peut provoquer un brouillage préjudiciable, auquel cas l'utilisateur sera tenu de corriger la situation à ses frais.

PRECAUTIONS

⚠ WARNING! NEVER operate the transceiver with an earphone or other audio accessories at high volume levels. Continuous high volume operation may cause a ringing in your ears. If you experience ringing, reduce the volume level or discontinue use.

⚠ WARNING! NEVER connect the transceiver to an AC outlet or to a power source of more than 28 V DC. Such a connection will damage the transceiver.

CAUTION: NEVER connect the transceiver to a power source that is DC fused at more than 10 A. Accidental reverse connection will be protected by this fuse, higher fuse values will not give any protection against such accidents and the transceiver will be damaged.

DO NOT operate the transceiver near unshielded electric blasting caps or in an explosive atmosphere.

DO NOT connect the transceiver to a power source using reverse polarity. This connection will not only blow fuses but also may damage the transceiver.

DO NOT place unit in a non-secure place to avoid inadvertent use by children.

DO NOT push the PTT when not actually intending to transmit.

DO NOT use or place the transceiver in direct sunlight or in areas with temperatures below -20°C (-4°F) or above $+55^{\circ}\text{C}$ ($+131^{\circ}\text{F}$).

DO NOT place the transceiver in excessively dusty environments.

DO NOT use harsh solvents such as benzine or alcohol to clean the transceiver, as they will damage the transceiver's surfaces. If the transceiver becomes dusty or dirty, wipe it clean with a soft, dry cloth.

BE CAREFUL! The transceiver will become hot when operating continuously for long periods.

CAUTION: Use of 8.33 kHz Channel Spacing of this radio is strictly prohibited and shall not be used in Canada.

PRÉCAUTIONS

⚠ **NE JAMAIS** utiliser l'émetteur-récepteur avec un casque ou d'autres accessoires audio ayant un volume trop élevé. Un volume continu trop fort peut entraîner un bourdonnement dans vos oreilles. Si vous entendez une sonnerie baissez le niveau sonore ou interrompez l'utilisation.

⚠ **NE JAMAIS** relier l'émetteur-récepteur à une prise d'alimentation de plus de 28 V. Un tel branchement endommagerait votre émetteur-récepteur.

NE JAMAIS brancher l'émetteur-récepteur à une alimentation continue dont le fusible de protection excède 10 A. Ce fusible protège contre l'inversion accidentelle des branchements.

NE PAS utiliser l'émetteur-récepteur près d'amorces électriques non blindées ou en atmosphère explosive.

NE JAMAIS brancher le transceiver à une source d'alimentation employant la polarité inversée.

NE PAS appuyer sur la touche PTT lorsqu'on ne souhaite pas émettre.

NE PAS d'utiliser ou d'exposer l'émetteur-récepteur en plein soleil ou à une température ambiante inférieure à -20°C ou supérieure à $+55^{\circ}\text{C}$.

NE PAS placer l'émetteur-récepteur dans des endroits excessivement poussiéreux.

NE PAS nettoyer l'appareil avec des solvants agressifs tels que benzène ou alcool, susceptibles d'endommager les surfaces exposées du boîtier. En cas de dépôt de poussière ou de salissures sur l'émetteur-récepteur, il faut l'essuyer avec chiffon doux et sec.

ATTENTION! Le transceiver devient chaud lors d'utilisations continues de longue durée. L'émetteur-récepteur chauffe en cas d'utilisation continue sur une longue durée.

L'antenne doit être placée à au moins un mètre de la position de chacune des personnes à bord de l'aéronef.

MISE EN GARDE: Utilisation de 8,33 kHz Espacement des canaux de cette radio est strictement interdite et ne doit pas être utilisé au Canada.

SAFETY TRAINING INFORMATION



Your Icom radio generates RF electromagnetic energy during transmit mode. This radio is designed for and classified as “Occupational Use Only,” meaning it must be used only during the course of employment by individuals aware of the hazards, and the ways to minimize such hazards. This radio is **NOT intended for use by the “General Population” in an uncontrolled environment.**

- For compliance with FCC and Industry Canada RF Exposure Requirements, the transmitter antenna installation shall comply with the following two conditions:

1. The transmitter antenna gain shall not exceed 0 dBi.
2. The antenna is required to be located outside of a vehicle and kept at a distance of 40 centimeters or more between the transmitting antenna of this device and any persons during operation. For a small vehicle, the antenna as worst case, the antenna shall be located on the roof top at any place on the centre line along the vehicle in order to achieve 40 centimeters separation distance. In order to ensure this distance is met, the installation of the antenna must be mounted at least 40 centimeters away from the nearest edge of the vehicle in order to protect against exposure to bystanders.



To ensure that your exposure to RF electromagnetic energy is within the FCC allowable limits for occupational use, always adhere to the following guidelines:

- **DO NOT** operate the radio without a proper antenna attached, as this may damage the radio and may also cause you to exceed FCC RF exposure limits. A proper antenna is the antenna supplied with this radio by the manufacturer or an antenna specifically authorized by the manufacturer for use with this radio.
- **DO NOT** transmit for more than 50% of total radio use time (“50% duty cycle”). Transmitting more than 50% of the time can cause FCC RF exposure compliance requirements to be exceeded. The radio is transmitting when the “TX” indicator appears. You can cause the radio to transmit by pressing the PTT switch.

Electromagnetic Interference/Compatibility

During transmissions, your Icom radio generates RF energy that can possibly cause interference with other devices or systems. To avoid such interference, turn off the radio in areas where signs are posted to do so. **DO NOT** operate the transmitter in areas that are sensitive to electromagnetic radiation such as hospitals, aircraft, and blasting sites.

INFORMATION EN MATIÈRE DE SÉCURITÉ



AVERTISSEMENT

Votre radio Icom produit une énergie électromagnétique de radiofréquences (RF), en mode de transmission. Cette radio est conçue pour un «usage professionnel seulement» et classée comme tel, ce qui signifie qu'elle doit être utilisée uniquement dans le cadre d'un travail par des personnes conscientes des dangers et des mesures visant à minimiser ces dangers. Elle **N'EST PAS** conçue pour une «utilisation grand public», dans un environnement non contrôlé.

- Afin de satisfaire aux exigences de la FCC et d'Industrie Canada en matière d'exposition aux RF, il est nécessaire que l'antenne soit installée conformément aux deux conditions suivantes:

1. Le gain de l'antenne du radio émetteur ne doit pas dépasser 0 dBi.
2. Il faut que l'antenne émettrice de cet appareil soit placée à l'extérieur d'un véhicule et tenue éloignée d'au moins 40 centimètres de toute personne pendant le fonctionnement. Dans le pire des cas, pour un petit véhicule, l'antenne doit être placée sur le toit, n'importe où dans l'axe central du véhicule, afin de respecter une distance de 40 cm du bord le plus rapproché du véhicule et ainsi éviter que les personnes présentes soient exposées.



MISE EN GARDE

Afin de vous assurer que votre exposition à une énergie électromagnétique de RF se situe dans les limites permises par la FCC pour une utilisation grand public, veuillez en tout temps respecter les directives suivantes:

- **NE PAS** faire fonctionner la radio sans qu'une antenne appropriée y soit fixée, car ceci risque d'endommager la radio et causer une exposition supérieure aux limites établies par la FCC. L'antenne appropriée est celle qui est fournie avec cette radio par le fabricant ou une antenne spécialement autorisée par le fabricant pour être utilisée avec cette radio.
- **NE PAS** émettre pendant plus de 50% du temps total d'utilisation de l'appareil («50% du facteur d'utilisation»). Émettre pendant plus de 50% du temps total d'utilisation peut causer une exposition aux RF supérieure aux limites établies par la FCC. La radio est en train d'émettre lorsque le témoin du mode de transmission s'affiche sur l'écran ACL. La radio émettra si vous appuyez sur le bouton du microphone.

Interférence électromagnétique et compatibilité

En mode de transmission, votre radio Icom produit de l'énergie de RF qui peut provoquer des interférences avec d'autres appareils ou systèmes. Pour éviter de telles interférences, mettez la radio hors tension dans les secteurs où une signalisation l'exige. **NE PAS** faire fonctionner l'émetteur dans des secteurs sensibles au rayonnement électromagnétique tels que les hôpitaux, les aéronefs et les sites de dynamitage.

TABLE OF CONTENTS

IMPORTANT	i
EXPLICIT DEFINITIONS	i
FCC INFORMATION	i
PRECAUTIONS	ii
PRÉCAUTIONS	iii
SAFETY TRAINING INFORMATION	iv
INFORMATION EN MATIÈRE DE SÉCURITÉ	v
TABLE OF CONTENTS	vi
1 PANEL DESCRIPTION	1
■ Front panel	1
■ Rear panel	2
■ Function display	3
2 BASIC OPERATION	4
■ General description	4
■ Receiving and transmitting	5
■ Directly setting the frequency	6
■ Squelch settings	6
3 MEMORY OPERATION	7
■ General description	7
■ Basic operation	8
■ Editing Regular memory/Group memory channels	8
■ Selecting a weather memory channel	12
■ History memory channel	12
■ Selecting a GPS memory channel	13

■ Editing GPS memory	13
■ Protecting memory	13
4 OTHER FUNCTIONS	14
■ Dualwatch operation	14
■ Priority watch	14
■ Using the lock function	15
■ Accessing the 121.5 MHz emergency frequency	15
■ Enabling the intercom	16
■ Opening the squelch for test	16
■ Setting the frequency step	16
■ Using the remote control	16
■ Scanning the weather memory channels	17
5 MENU MODE	18
■ Using the menu mode	18
■ Settings menu items	20
■ Configuration menu items	22
6 OPTIONS	26
7 SPECIFICATIONS	27
8 INFORMATION	29
■ Country code list	29
■ Disposal	29
INDEX	30

1

PANEL DESCRIPTION

■ Front panel

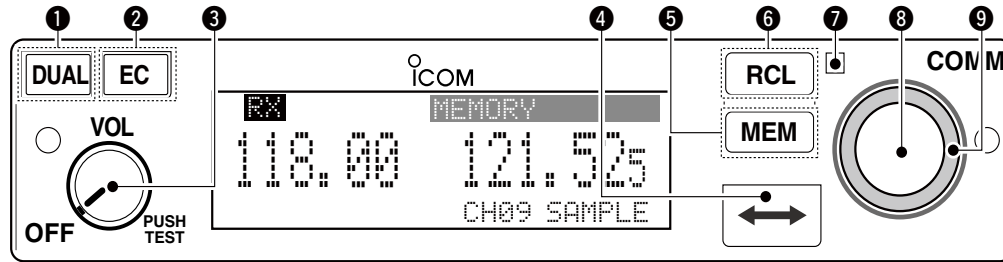

① DUAL SWITCH [DUAL]

- Push to turn Dualwatch operation ON or OFF. (p. 14)
- Hold down for two seconds to turn the intercom function ON or OFF.

② EMERGENCY CHANNEL SWITCH [EC]

- Push to set the emergency frequency (121.5 MHz) as the standby frequency. (p. 15)
- Hold down for two seconds to enter the direct frequency setting mode (p. 6), and set the emergency frequency (121.5 MHz). (p. 15)

③ VOLUME/POWER SWITCH [VOL]

- Turn [VOL] to switch the power ON or OFF.
- Adjusts the audio output level.
The volume level bar is displayed while rotating [VOL].
- Hold down for two seconds to enter the AM squelch level "SQL LEVEL" item in the Settings menu. (p. 6)
- Push to set the squelch test function ON or OFF. (p. 16)*

*When the squelch test function is ON, and the Auto squelch "AUTO SQL" item in the Configuration menu (p. 22) is set to "USER SET," push [VOL] again to switch the squelch mode. (p. 6)

CAUTION: DO NOT turn ON power until the engines have been started. Otherwise, the power supply circuit may damage.

4 FREQUENCY EXCHANGE (FLIP-FLOP) SWITCH [↔]

- Push to exchange the standby frequency with the active frequency. (p. 5)
- Hold down for two seconds to enter the direct frequency setting mode. (p. 6)

5 MEMORY SWITCH [MEM]

Hold down for two seconds to enter a displayed frequency into any blank regular memory channel or delete or revive the selected memory channel (depending on the operating mode).

6 RECALL SWITCH [RCL]

- Push to enter and exit the memory mode. (p. 8)
- Hold down for two seconds to enter the Settings menu. (p. 18)
- Push to exit the Settings menu. (p. 18)

7 LIGHT-SENSITIVE DETECTOR

This detector senses ambient light. The detector is used to automatically adjust “DISP LOW” or “DISP HIGH” (pp. 23, 24) when the “DISP MODE” (p. 23) is set to ‘AUTO.’

8 INNER (Small) TUNING DIAL [DIAL]

- Rotate to set the standby frequencies (kHz digit) (p. 5), memory channels (p. 8), and menu mode settings. (pp. 18, 19)
- Hold down for two seconds to turn ON the dial/panel lock mode. (p. 15)

9 OUTER (Large) TUNING DIAL [O-DIAL]

Rotate to set the standby frequency (MHz digit) (p. 5), group memory channel (p. 8), select the input digit for group name (p. 10), and so on.

■ Rear panel

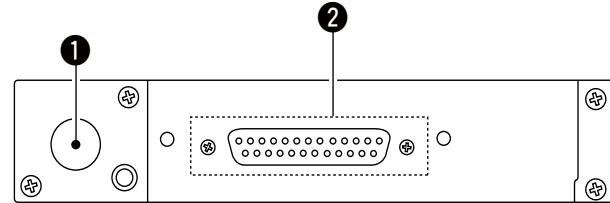

1 ANTENNA CONNECTOR

Connect the antenna connector.

2 D-SUB 25 PIN CONNECTOR

Connect a 13.8 V or 27.5 V DC power supply, speaker, headset and third party GPS receiver*.

Refer to ‘INSTALLATION GUIDE’ for details.

*Ask your dealer for available GPS receiver details.

1 PANEL DESCRIPTION

■ Function display

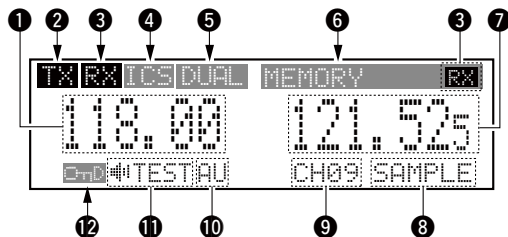

1 ACTIVE FREQUENCY READOUT

- Displays the active frequency. (p. 5)
- Displays the menu mode items in the menu mode. (p. 18)

2 TX INDICATOR

Displayed while transmitting. (p. 5)

3 RX INDICATOR

- Displayed when receiving a signal on the active frequency. (p. 5)
- Displayed when receiving a signal on the standby frequency during Dualwatch operation. (p. 14)
- Displayed when opening the active frequency's squelch function. (p. 5)

4 INTERCOM READOUT

Displays "ICS" when the intercom function is in use. (p. 16)

5 DUALWATCH READOUT

Displays "DUAL" when the Dualwatch function is ON. (p. 14)

6 MEMORY TYPE READOUT

- Displays "MEMORY" when the regular memory channel is selected. (p. 8)
- Displays "GRP01"–"GRP05" when the group memory channel is selected. (p. 8)
The group name is also displayed if the name has been entered.
- Displays "HISTORY" when the history memory channel is selected. (p. 12)
- Displays "WEATHER" when the weather memory channel is selected. (p. 12)*

*For only U.S.A. version transceivers.

- Displays "GPS" when the GPS memory channel is selected. (p. 13)

- A third party GPS receiver is required.

7 STANDBY FREQUENCY READOUT

- Displays the standby frequency. (p. 5)
- Displays the setting values in the menu mode. (p. 18)

8 CHANNEL NAME READOUT

Displays the channel name in the memory mode. (p. 10)

9 MEMORY CHANNEL READOUT

Displays the selected memory channel number in the memory mode. (p. 8)

10 SQUELCH MODE READOUT

Displays the squelch mode status. (pp. 6, 20)

11 TEST INDICATOR

Displays "TEST" while the squelch test function is ON. (p. 16)

12 LOCK INDICATOR (p. 15)

- Displays "LOCK" while the dial lock function is in use.
- Displays "PL" while the panel lock function is in use.

■ General description

The flow chart below shows the basic operating procedures. You need to set the frequency, activate the frequency, and receive or transmit.

There are two ways to set the frequency. Refer to page 5 and 6 for details.

• Set the frequency normally

Set the standby frequency.



Activate the frequency.



• Set the frequency directly

Enter the direct frequency setting mode.



Set the operating frequency.



Receive/transmit

Set the frequency normally

Set the desired frequency which will be used for the next operating frequency in the standby frequency display. Then exchange the active frequency for the standby frequency.

Set the frequency directly

You can directly enter the desired frequency. Refer to 'Directly setting the frequency.'

TIP: For quick frequency setting, you can enter often-used frequencies into memory channels. Refer to "MEMORY OPERATION" for details. (pp. 7–13)
When you recall a memory channel, the previous standby frequency is erased.

2 BASIC OPERATION

■ Receiving and transmitting

1. Setting the standby frequency

Rotate [DIAL] and [O-DIAL] to select the desired frequency as the standby frequency.

- The active frequency is not affected.
- Rotate [O-DIAL] to set above 1 MHz digit.
- Rotate [DIAL] to set below 100 kHz digit.
- You can set the frequency step in the Settings menu. (p. 21)

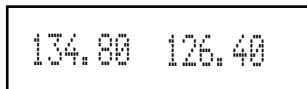

2. Exchanging the frequency

After setting the standby frequency, push [↔] to exchange it with the active frequency.

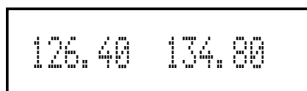

NOTE: DO NOT hold down [↔] continuously. Otherwise, the standby frequency disappears. If this happens, again hold down [↔] until the standby frequency reappears.

3. Receiving

When receiving a signal, "RX" is displayed and audio is heard.

- Rotate [VOL] to adjust the audio level.
- Adjust the squelch if necessary. Refer to 'Squelch settings' for details.

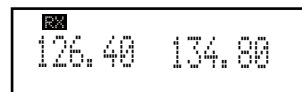

4. Transmitting

- ① Hold down PTT switch, and then speak at your normal voice level.
 - "TX" is displayed.
 - **DO NOT** hold the microphone too closely to your mouth or speak too loudly. This may distort your signal.

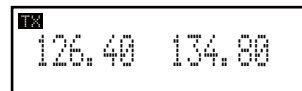

- ② Release the PTT switch to receive.

NOTE: To prevent interference, listen on the frequency before transmitting. If the frequency is busy, wait until it is clear.

■ Directly setting the frequency

You can also directly set the desired frequency.

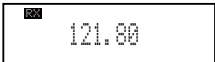
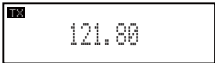
- ① Hold down [↔] for two seconds to enter the direct frequency setting mode.
 - Only the active frequency is displayed.
- ② Set an operating frequency.
 - Rotate [O-DIAL] to set above 1 MHz 
 - Rotate [DIAL] to set below 100 kHz digit.
 - You can set the frequency step in the Settings menu. (p. 21)
- ③ When receiving a signal, "RX" is displayed and audio is heard. 
 - Rotate [VOL] to adjust the audio level.
 - Adjust the squelch if necessary. Refer to 'Squelch settings' for details.
- ④ Hold down PTT switch, and then speak at your normal voice level.
 - "TX" is displayed. 
 - **DO NOT** hold the microphone too closely to your mouth or speak too loudly. This may distort your signal.
- ⑤ Release the PTT switch to receive.
- ⑥ Push [RCL] or [↔] to exit the direct frequency setting mode.

■ Squelch settings



◇ Adjusting the squelch

Adjust the squelch to mute undesired noise when no signal received.

- ① Hold down [VOL] for two seconds to enter "SQL LEVEL."
- ② Rotate [DIAL] to select the desired squelch level to be between -10 and 10.
- ③ Push [RCL] to exit "SQL LEVEL."

◇ Switching the squelch mode

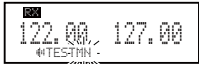
You can switch the squelch mode when the Auto squelch "AUTO SQL" item in the Configuration menu (p. 22) is set to "USER SET."

- ① Push [VOL] to turn ON the squelch test function. 
 - "RX" and "#TEST" are displayed.
 - The squelch mode readout "MN" or "AU" blinks.
- ② Push [VOL] again while the squelch mode readout is blinking to switch the squelch mode. 
 - "RX" and "#TEST" disappear and the squelch test function is turned OFF.
 - MN (manual): Uses the squelch level set in "SQL LEVEL."
 - AU (auto): Prevents the audio from breaking up while receiving weak signals.
- ③ Repeat ① through ② to switch the squelch mode again.

3

MEMORY OPERATION

■ General description

The transceiver has memory to store frequently used frequencies. You can easily set the desired frequency by selecting the channel from the memory.

The figure below shows the structure of the memory mode. There are five memory channel types*.

*There may be 4 memory types, depending on the transceiver version.

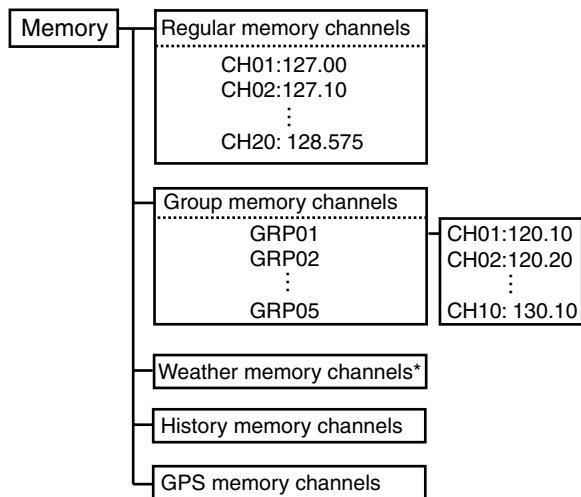

◇ Memory channel types

Regular memory channels (MEMORY)

Up to 20 memory channels can be selected.

Group memory channels (GRP01–GRP05)

There are up to 50 group channels, with 10 channels in each of 5 groups.

Weather memory channels (WEATHER)*

10 weather memory channels can be selected.

These are used for monitoring NOAA (National Oceanic and Atmospheric Administration) broadcasts.

*For only U.S.A. version transceivers

History memory channels (HISTORY)

Up to 20 history memory channels can be selected.

The active frequency is automatically written into history memory channels when you push [↔] to exchange the active and standby frequencies. (except weather memory channels: For only U.S.A. version transceivers.)

GPS memory channels (GPS)

Up to 10 GPS memory channels can be selected.

When connected to an external GPS receiver* equipped with an airport frequency database, you can enter the frequency data at nearby airports into the GPS memory channels.

* Ask your dealer for available GPS receiver details.

■ Basic operation

- ① Push **[RCL]** to enter the memory mode.

- The memory channel number is displayed.

- The memory channel name is also displayed if it has been entered.



- ② Rotate **[O-DIAL]** to select the memory channel types.

- For the group memory channel, push **[DIAL]** and then rotate **[O-DIAL]** to select a group.



- ③ Rotate **[DIAL]** to select the desired channel.



- ④ Push **[RCL]** to change standby frequency to the selected frequency and exit the memory mode.

- For the group memory channel, push **[RCL]** twice to change the standby frequency to the selected frequency and exit the memory channel.

- Hold down **[RCL]** for two seconds to exit the memory mode without changing the previously set standby frequency.

- ⑤ Push **[↔]** to exchange to the active frequency.

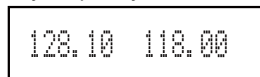

■ Editing Regular memory/ Group memory channels

◇ Memory mode menu

There are memory mode menus to edit the memory contents. They contain the following items.

REPLACE (p. 9)

Enter the selected memory channel frequency to the standby frequency.

DELETE (p. 9)

Deletes the selected memory channel frequency.

REVIVE

Returns the selected memory channel to its previous state.

CH NAME (For only regular memory channel)

Sets the channel name to the selected regular memory channel.

GRP NAME (For only group memory channel)

Sets the group name to the selected memory group.

CH TAG (For only group memory channel)

Sets the channel tag to the selected memory channel. (Selecting the group memory channel is the only option.)

DONE

Returns to the memory mode.

3 MEMORY OPERATION

◇ Enter frequencies into memory channels

To enter frequencies into memory channels, follow the steps below.

- ① Rotate **[DIAL]** and **[O-DIAL]** to set the desired frequency for the standby frequency.
 - ② Push **[RCL]** to enter the memory mode.
 - The memory channel number is displayed.
 - The memory channel name is also displayed if it has been entered.
 - ③ Rotate **[O-DIAL]** to select a desired memory channel.
 - Select regular memory channels or group memory channels.
 - For the group memory channel, push **[DIAL]** and then rotate **[O-DIAL]** to select a group.
 - ④ Push **[MEM]** and then rotate **[O-DIAL]** to select “REPLACE.”
 - The channel number blinks.
 - For the group memory channel, push **[DIAL]**, **[MEM]** and then rotate **[O-DIAL]** to select “REPLACE.”
- 
- The image shows a digital display with the following text: 'MEMORY' at the top, '128.000' on the right, '122.00' on the left, 'REPLACE' in the center, '127.000' on the right, and '- CH01 -' at the bottom. There are also some graphical elements like a cursor and a bar.
- ⑤ Rotate **[DIAL]** to select a channel to be entered.
 - ⑥ Push **[MEM]** to enter the frequency into the channel.
 - “WRITE COMPLETED” is displayed when the regular memory channel is entered.
 - ⑦ Push **[RCL]** to exit the memory mode.
 - For the group memory channel, hold down **[RCL]** for two seconds to exit the memory mode.

◇ Clearing the memory contents

You can clear unwanted memory channels.

- ① Push **[RCL]** to enter the memory mode.
 - The memory channel number is displayed.
 - The memory channel name is also displayed if it has been entered.
- ② Rotate **[O-DIAL]** to select a desired memory channel.
 - Select regular memory channels or group memory channels.
 - For the group memory channels, push **[DIAL]** and then rotate **[O-DIAL]** to select a group.
- ③ Rotate **[DIAL]** to select a desired channel.
- ④ Push **[MEM]** and then rotate **[O-DIAL]** to select “DELETE.”
 - The channel number blinks.
 - For the group memory channel, push **[DIAL]**, **[MEM]** and then rotate **[O-DIAL]** to select “DELETE.”



- ⑤ Push **[MEM]** to clear the memory channel data.



- ⑥ Push **[RCL]** to exit the memory mode.
 - For the group memory channel, hold down **[RCL]** for two seconds to exit the memory mode.

◇ Entering channel names

(For only regular memory channels)

The regular memory channels can display a six character name in addition to the memory number.

- ① Push **[RCL]** to enter the memory mode, and then rotate **[O-DIAL]** to select the regular memory channel.
- ② Rotate **[DIAL]** to select a desired channel.
- ③ Push **[MEM]** and then rotate **[O-DIAL]** to select “CH NAME.”
- ④ Push **[MEM]**.
 - The channel name’s 1st digit blinks.
- ⑤ Rotate **[DIAL]** to select a desired character.
 - Push **[DIAL]** to switch from upper case letters (A, B, C, ...) → lower case (a, b, c, ...) → number (0, 1, 2, ...) → then again to upper case letters (A, B, C, ...) in sequential order.
 - You can enter the characters listed below.

A B C D E F G H I J K L M N O P Q R S T U V W X Y Z [\] ^ _ `
a b c d e f g h i j k l m n o p q r s t u v w x y z { } ~ (space) ! " # \$ % & ' () * + , - . /
0 1 2 3 4 5 6 7 8 9 : ; < = > ? @

- ⑥ Rotate **[O-DIAL]** to select the next input digit.
- ⑦ Repeat ⑤–⑥ to enter the memory channel name.
- ⑧ Push **[MEM]** to set the memory channel name.
- ⑨ Push **[RCL]** to exit the memory mode.

◇ Entering group names

(For only group memory channels)

The memory groups can display a six character name in addition to the group number (“GRP01”–“GRP05”).

- ① Push **[RCL]** to enter the memory mode, and then rotate **[O-DIAL]** to select the group memory channel.
- ② Push **[DIAL]** and then rotate **[O-DIAL]** to select a memory group from GRP01 to GRP05.
 - Push **[DIAL]** again to set the memory group.
- ③ Push **[MEM]** and then rotate **[O-DIAL]** to select “GRP NAME.”
- ④ Push **[MEM]**.
 - The channel name’s 1st digit blinks.
- ⑤ Rotate **[DIAL]** to select the desired character.
 - Push **[DIAL]** to switch from upper case letters (A, B, C, ...) → lower case (a, b, c, ...) → number (0, 1, 2, ...) → then again to upper case letters (A, B, C, ...) in sequential order.
 - You can enter the characters listed below.

A B C D E F G H I J K L M N O P Q R S T U V W X Y Z [\] ^ _ `
a b c d e f g h i j k l m n o p q r s t u v w x y z { } ~ (space) ! " # \$ % & ' () * + , - . /
0 1 2 3 4 5 6 7 8 9 : ; < = > ? @

- ⑥ Rotate **[O-DIAL]** to select the next input digit.
- ⑦ Repeat ⑤–⑥ to input the group name.
- ⑧ Push **[MEM]** to set the group name.
- ⑨ Hold down **[RCL]** to exit the memory mode.

3 MEMORY OPERATION

◇ Selecting channel tag names

(For only group memory channels)

The tag name can be set to a three character name, in addition to the group number. It is convenient for separating memory types.

- ① Push **[RCL]** to enter the memory mode, and then rotate **[O-DIAL]** to select group memory channel.
- ② Push **[DIAL]** and then rotate **[O-DIAL]** to select a memory group from GRP01 to GRP05.
 - Push **[DIAL]** again to set the memory group.
- ③ Push **[MEM]** and then rotate **[O-DIAL]** to select “CH TAG.”
- ④ Push **[MEM]** and then rotate **[DIAL]** to select the desired channel tag.
 - The tag name shown to the right is selectable.
- ⑤ Push **[MEM]** to set the channel tag.
- ⑥ Hold down **[RCL]** to exit the memory mode.



Channel tag list

TAG NAME	DISPLAY		MEANS
	Group*1	GPS*2	
---	YES	--	Non-tag
TWR	YES	YES	Tower
GND	YES	YES	Ground
ATS	YES	YES	ATIS
ATF	YES	YES	Air traffic
APP	YES	YES	Approach
ARR	YES	YES	Arrival
AWS	YES	YES	Automatic Weather Station
CLR	YES	YES	Clearance / Delivery
CTF	YES	YES	Common Traffic Advisory Frequency
DEP	YES	YES	Departure
FSS	YES	YES	Flight Service Station
RFS	YES	YES	Remote Flight Service Station
UNI	YES	YES	Unicom frequency
MF	YES	YES	Mandatory frequency
OTH	YES	--	Other
U-1	YES	--	User1 setting (p. 24)
U-2	YES	--	User2 setting (p. 24)

*1Group memory, *2GPS memory

About U-1/U-2

You can edit U-1 and U-2 to the desired tag name in the Configuration menu. Refer to page 24 for the details.

■ Selecting a weather memory channel

(For only U.S.A. version transceivers)

The U.S.A. version transceivers have built-in VHF marine WX (weather) channels.

- ① Push **[RCL]** to enter the memory mode.
- ② Rotate **[O-DIAL]** to select "WEATHER."
- ③ Rotate **[DIAL]** to set a desired weather memory channel.
- ④ Push **[RCL]** to exit the memory mode.



• Weather memory channel list

Channel	Frequency	Channel	Frequency
WX01	162.550 MHz	WX06	162.500 MHz
WX02	162.400 MHz	WX07	162.525 MHz
WX03	162.475 MHz	WX08	161.650 MHz
WX04	162.425 MHz	WX09	161.775 MHz
WX05	162.450 MHz	WX10	163.275 MHz

■ History memory channel

The transceiver has 20 history memory channels.

When pushing **[↔]**, the standby frequency is stored into a history memory channel.

The frequencies are stored into the history memory channel from "CH01" to "CH20."

- ① Push **[RCL]** to enter the memory mode.
- ② Rotate **[O-DIAL]** to select "HISTORY."
- ③ Rotate **[DIAL]** to set a desired history memory channel.
- ④ Push **[RCL]** to exit the memory mode.



3 MEMORY OPERATION

■ Selecting a GPS memory channel

When connected to an external GPS receiver* with an airport frequency database, you can transfer frequency data such as nearby airports to the GPS memory (maximum 10 memory channels).

*Ask your dealer for available GPS receiver details.

NOTE: Refer to the GPS receiver's instruction manual for transferring the frequency data.

- ① Push **[RCL]** to enter the memory mode.
- ② Rotate **[O-DIAL]** to select "GPS."
- ③ Rotate **[DIAL]** to set a desired GPS memory channel.
- ④ Push **[RCL]** to exit the memory mode.

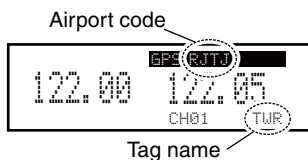

■ Editing GPS memory

The received GPS memory data is stored in the desired group memory channel.

NOTE: The GPS memory data is overwritten if the selected GPS memory channel already contains other data.

- ① Push **[RCL]** to enter the memory mode.
- ② Rotate **[O-DIAL]** to select "GPS."
 - "GPS" is displayed.
- ③ Push **[MEM]** to enter the GPS memory channel edit mode, then rotate **[O-DIAL]** to select a desired group memory.
 - "GPS" and airport code blink.
- ④ Push **[MEM]** to store the GPS memory channel data to the selected group memory.
- ⑤ Push **[RCL]** to exit the memory mode.

■ Protecting memory

The transceiver has memory protection which inhibits the editing (storing, deleting, replacing, and so on) of the regular memory and group memory.

Refer to 'Memory Protection' (p. 22) for details.

■ Dualwatch operation

The Dualwatch operation monitors the active frequency at certain intervals, even when receiving a signal on the standby frequency. When a signal is received on the active frequency, the transceiver switches to the active frequency and stays on it until the signal disappears, irrespective of the standby frequency status.

- ① Push **[DUAL]** to enter Dualwatch operation.
 - “DUAL” is displayed on the active frequency display.
 - The active or standby frequency’s “RX” blinks when receiving a signal, or the squelch opens.



- ② Push **[DUAL]** again to exit Dualwatch operation.
 - “DUAL” disappears.

ATTENTION! During Dualwatch operation, the standby frequency’s audio may be interrupted during the monitoring interval, but this is not a malfunction.

■ Priority watch

The Priority watch operation monitors the active frequency at certain intervals* even when receiving a signal on the standby frequency. When a signal is received on the active frequency and standby at the same time, the transceiver preferentially receives the active frequency and stops receiving the standby frequency.

*You can set the priority watch intervals in the Configuration menu. Refer to page 22 for details.

4 OTHER FUNCTIONS

■ Using the lock function

The lock function prevents accidental frequency changes and accidental function activation. There are two lock modes, panel lock and dial lock.

You can select the lock mode in the Settings menu. Refer to page 20 for details.

Panel lock: Lock transceiver's keys and dials except **[EC]** and **[VOL]**.

Dial lock: Lock **[DIAL]** and **[O-DIAL]**.

- ① Hold down **[DIAL]** for two seconds to turn ON the lock function.
 - **[DIAL]** is displayed when dial lock mode is selected.
 - **[PANEL]** is displayed when panel lock mode is selected.
- ② Push **[DIAL]** to turn OFF the lock function.
 - **[DIAL]** or **[PANEL]** disappears.

NOTE: LOCK RELEASE FUNCTION

This transceiver has a lock release function that releases the Lock function when an operator gets into a panic.

The lock function is released when pushing any keys (except **[EC]**) eight times, or rotate any dial (except **[VOL]**) 25 clicks in five seconds.

■ Accessing the 121.5 MHz emergency frequency

The transceiver can be set to the 121.5 MHz emergency frequency immediately. This function can be activated even if the key lock function is in use.

- ① Hold down **[EC]** for two seconds to set the emergency frequency (121.50 MHz) in direct frequency setting mode.
 - "EC" is displayed.

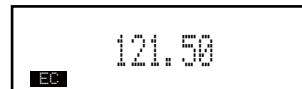

- ② Hold down **[↔]** to return to the normal frequency display mode, and then push **[↔]** to exchange emergency frequency with the standby frequency.
 - Set the frequency other than 121.500 MHz before pushing **[↔]** to the standby frequency if necessary.
 - "EC" disappears.

You can also set the 121.5 MHz emergency frequency from normal frequency display mode.

- ① Push **[EC]** to set the emergency frequency to the standby frequency.
- ② Push **[↔]** to change to the active frequency.
 - "EC" is displayed.

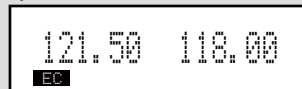

■ Enabling the intercom

When two headsets are connected to the transceiver, you can use them as a voice-activated intercom.

- ① While holding down **[DUAL]**, rotate **[VOL]** to turn ON the transceiver's power.
 - Configuration menu is displayed.
- ② Rotate **[O-DIAL]** to select "INCOM MODE."
- ③ Rotate **[DIAL]** to set the intercom usable setting to ON.
- ④ Push **[RCL]** to exit the Configuration menu and restart the transceiver.
- ⑤ Hold down **[DUAL]** for two seconds to enable the intercom function.
 - "ICS" is displayed.
 - You can set the headphone output level in the Settings menu. (p. 20)
 - You can also set microphone 1 and microphone 2 audio input levels in the Settings menu. (p. 20)

■ Opening the squelch for test

This function manually opens the squelch for testing.

- ① Push **[VOL]** to turn ON the squelch test function.
 - "RX" and "TEST" are displayed.
- ② To turn the function OFF, push **[VOL]** again.
 - "RX" and "TEST" disappear.

■ Setting the frequency step

You can select Frequency steps of 8.33 kHz or 25 kHz in the menu mode.

- ① Hold down **[RCL]** for two seconds to enter the Settings menu.
- ② Rotate **[O-DIAL]** to select "FREQ. STEP"
- ③ Rotate **[DIAL]** to select the desired frequency steps of 8.33 kHz or 25 kHz.
- ④ Push **[RCL]** to exit the Settings menu.

CAUTION: Use of 8.33 kHz Channel Spacing of this radio is strictly prohibited and shall not be used in Canada.

■ Using the remote control

You can remotely control the frequency exchange switch, intercom, and recall switch by connecting pins 1, 3, and 17* of the D-Sub 25 pin connector on the rear panel to the switches connected to the power ground.

Refer to "INSTALLATION GUIDE" for details.

- Turn the remote control in the Configuration menu ON. Refer to page 25 for details.

*Connect pins L, 10, and 15 to the switches connected to the power ground if you are using the optional MBA-3 connector.

4 OTHER FUNCTIONS

■ Scanning the weather memory channels

(For only U.S.A. version transceivers)

Scanning automatically searches for weather channel signals.

Repeatedly scans all weather memory channels.

You can set the interval time (scan speed) for the scan in the Settings menu. Refer to page 22 for details.

- ① Push **[RCL]** to enter the memory mode, and then rotate **[O-DIAL]** to select the weather memory channel.
- ② Hold down **[VOL]** for two seconds to start a weather memory channel scan.
 - “SEARCH” blinks while scanning.
 - To change the scan direction, turn **[DIAL]**.
 - The scan continues even when receiving a signal on the active frequency.



- ③ When receiving a signal on the weather channel:
 - “RX” blinks on the standby frequency display and the scan is cancelled.
 - “DUAL” is displayed on the active frequency display.



- ④ When no signal is received on the weather channel:
 - “NO WTH” is displayed even searches “WX01” to “WX10” channels for three times and the scan is cancelled.
- ⑤ Hold down **[VOL]** for two seconds to cancel the scan manually.

■ Using the menu mode

The menu mode is accessible at power ON and allows you to set seldom-changed settings. You can customize the transceiver settings to suit your preferences and operating style. There are two types of menu mode, Settings menu and Configuration menu.

◇ Using the Settings menu

- ① Rotate **[VOL]** to turn ON the transceiver's power.
 - Push **[RCL]** to exit memory mode if the memory mode is selected.
- ② Hold down **[RCL]** for two seconds to enter the Settings menu.
- ③ Rotate **[O-DIAL]** to select setting items.
- ④ Rotate **[DIAL]** to select a desired setting.
- ⑤ Push **[RCL]** to exit the Settings menu.

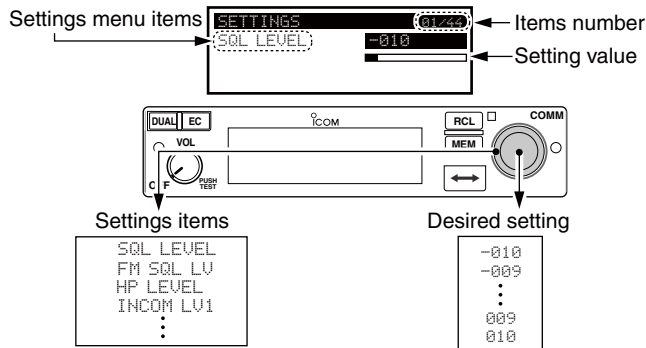

• Settings menu items

Item	Ref.	Item	Ref.
SQL LEVEL	p. 20	MIC1 GAIN	p. 21
SQL MODE	p. 20	MIC2 GAIN	p. 21
FM SQL LV	p. 20	SIDETONE LV	p. 21
HP LEVEL	p. 20	DISP MAN.	p. 21
INCOM LV1	p. 20	FREQ DISP	p. 21
INCOM LV2	p. 20	AUX LEVEL	p. 21
ANL	p. 20	BEEP	p. 21
LOCK MODE	p. 20	FREQ. STEP	p. 21

5 MENU MODE

◇ Using the Configuration menu

- ① While holding down [DUAL], rotate [VOL] to turn ON the transceiver's power.
 - Configuration menu is displayed.
- ② Rotate [O-DIAL] to select a setting item.
- ③ Rotate [DIAL] to select a desired setting.
- ④ Push [RCL] to exit the Configuration menu and restart the transceiver.

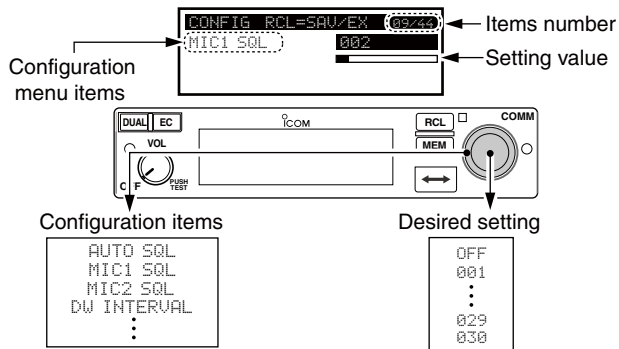

• Configuration menu items

Item	Ref.	Item	Ref.
AUTO SQL	p. 22	DISP HIGH	p. 24
SQL SW	p. 22	DISP RESP.	p. 24
MIC1 SQL	p. 22	U-1 ID SET	p. 24
MIC2 SQL	p. 22	U-2 ID SET	p. 24
DW INTERVAL	p. 22	AUX IN	p. 24
PRI. WATCH	p. 22	AUX MAX LEVEL	p. 24
PW INTERVAL	p. 22	INCOM MODE	p. 24
MEM PROTECT	p. 22	TIME OUT	p. 25
GRP MEMORY	p. 23	INTERLOCK	p. 25
TX MIC SEL	p. 23	INTLOCK MODE	p. 25
DISP MODE	p. 23	REM SWAP	p. 25
DISP AUTO	p. 23	REM INCOM	p. 25
DISP EXT	p. 23	REM RECALL	p. 25
DISP LOW	p. 23	MEM CLEAR	p. 25

■ Settings menu items

◇ AM squelch level “SQL LEVEL”

Adjust the squelch level for AM mode operation.

In order to receive signals properly, the squelch must be adjusted to the proper level.

- -010 to 010: Sets the AM squelch level to between -10 and 10.

◇ Squelch mode “SQL MODE”

Sets the squelch mode for AM mode operation*.

*Displayed only when the Auto squelch “AUTO SQL” item in the Configuration menu (p. 22) is set to “USER SET.”

- MN (manual): Use “SQL LEVEL” to set the squelch level.
- AU (auto): Prevents the audio from breaking up while receiving weak signals.

◇ FM squelch level “FM SQL LV”

(For only U.S.A. version transceivers)

Set the squelch level for FM mode operation.

- -010 to 010: Sets the FM squelch level to between -10 and 10.

◇ Headphone level “HP LEVEL”

Sets the headphone output level while receiving.

- AF gain: The output level is the same as [VOL].
- OFF (0): Mutes the headphone.
- 001 to 080: Sets the audio level to between 1 and 80.

◇ Intercom 1 microphone audio input level “IN-COM LV1”

Sets the intercom 1 microphone input level.

- OFF (0): Mutes the intercom1 microphone.
- 001 to 080: Sets the intercom1 input level to between 1 and 80.

◇ Intercom 2 microphone audio Input level “IN-COM LV2”

Sets the intercom 2 microphone input level.

- OFF (0): Mutes the intercom 2 microphone.
- 001 to 080: Sets the intercom 2 input level to between 1 and 80.

◇ Automatic noise limiter “ANL”

The ANL (Automatic Noise Limiter) function reduces noise components while receiving, such as those caused by engine ignition systems.

- OFF: ANL function is OFF.
- ON: ANL function is ON.

◇ Lock mode “LOCK MODE”

Sets the lock function.

- OFF : The lock function is OFF.
- DIAL: The lock function applies to [DIAL].
- PANEL: The lock function applies to switches on the front panel.

5 MENU MODE

◇ Setting microphone 1 Gain “MIC1 GAIN”

Sets microphone 1's gain.

- -010 to 010: Sets the microphone 1's gain to between -10 and 10.

◇ Setting microphone 2 Gain “MIC2 GAIN”

Sets microphone 2's gain.

- -010 to 010: Sets the microphone 2's gain to between -10 and 10.

◇ Sidetone level “SIDETONE LV”

When using an optional headset (user supplied) through an adapter, the transceiver sends your transmitted voice to the headset for monitoring.

*Ask your dealer in details.

- OFF (0): The sidetone function is OFF.
- 001 to 080: Sets the sidetone level to between 1 and 80.

◇ Manual dimmer control “DISP MAN.”

Sets the brightness manually to suit your own preferences.

- OFF: The display brightness is set to the minimum. The key backlight is OFF.
- 001 to 100: Sets the dimmer level to between 1 and 100.

◇ Frequency display “FREQ DISP”

Sets the 1 kHz digit frequency displaying on the OLED.

- OFF : The 1 kHz digit is not displayed on the OLED.
- ON : The 1 kHz digit is always displayed on the OLED.
- ZERO SUPP.: The 1 kHz digit is displayed only when the 1 kHz digit frequency is 5 kHz.

◇ External input level “AUX LEVEL”

Sets the external input level.

*Displayed only when the External input “AUX IN” item in the Configuration menu (p. 24) is set to “ON” or “INCOM.”

- OFF (0): The external input is disabled.
- 001 to 080: Sets the external input level to between 1 and 80.
- AF GAIN: Interlocked with [VOL].

◇ Beep tone level “BEEP”

Confirmation beep tones normally sound when storing memory, operating the time-out-timer function, and so on. These can be set at a desired beep level.

- OFF (0): The beep tone is OFF.
- 001 to 100: Sets the beep tone level to between 1 and 100.

NOTE: When using an external speaker, the beep tone level while the squelch is closed is fixed and cannot be changed in the Settings menu.

◇ Frequency step “FREQ. STEP”

Sets the desired frequency step: 8.33 kHz or 25 kHz.

- 25kHz: Sets the frequency step to 25 kHz.
- 8.33kHz: Sets the frequency step to 8.33 kHz.

CAUTION: Use of 8.33 kHz Channel Spacing of this radio is strictly prohibited and shall not be used in Canada.

■ Configuration menu items

◇ Auto squelch “AUTO SQL”

Sets the Auto squelch function.

- OFF: The Auto squelch is OFF.
- ON: The Auto squelch is ON.
- USER SET: Set the auto squelch in the Squelch mode “SQL MODE” item in the Settings menu. (p.20)

◇ Squelch mode switch setting “SQL SW”

Sets the length of time that the squelch mode readout (p. 3) blinks when you switch the squelch mode. (p. 6)

*Displayed only when the Auto squelch “AUTO SQL” item in the Configuration menu is set to “USER SET.”

- 002 to 010: Sets the length of time that the squelch mode readout blinks to between 2 seconds and 10 seconds.

◇ Intercom 1 squelch level “MIC1 SQL”

Sets Intercom 1’s squelch level.

The setting level is required to open the squelch when speaking into Intercom 1.

- OFF (0): Turns off Intercom 1’s squelch.
- 001 to 030: Sets Intercom 1’s squelch level to between 1 and 30.

◇ Intercom 2 squelch level “MIC2 SQL”

Set Intercom 2’s squelch level.

The setting level is required to open the squelch when speaking into Intercom 2.

- OFF (0): Turns off Intercom 2’s squelch.
- 001 to 030: Sets Intercom 2’s squelch level to between 1 and 30.

◇ Dualwatch interval “DW INTERVAL”

Sets the interval time while operating Dualwatch or weather scan.

- FAST: Sets the interval to 300 milliseconds.
- MID: Sets the interval to 600 milliseconds.
- SLOW: Sets the interval to two seconds.

◇ Priority watch “PRI.WATCH”

Sets the priority watch is enabled or not.

- ON: The priority watch is ON.
- OFF: The priority watch is OFF.

◇ Priority watch interval “PW INTERVAL”

Sets the active frequency receive interval time while receiving the standby frequency.

- FAST: Sets the interval to 400 milliseconds.
- MID: Sets the interval to 800 milliseconds.
- SLOW: Sets the interval to two seconds.

◇ Memory protection “MEM PROTECT”

Sets the memory protection to regular memory channels and group memory channels.

Editing the regular memory and group memory channels is inhibited while the protection is ON.

- OFF: The memory protection is OFF.
- ON: The memory protection is ON.

5 MENU MODE

◇ Group memory channel display “GRP MEMORY”

Select whether the label is displayed or not.

- CH: Only the memory channel number is displayed.
- LABEL: The label is also displayed.

◇ Transmitting microphone selection “TX MIC SEL”

Sets the active microphone when pushing microphone's PTT switch.

The item allows you to control which connected microphone is permitted to transmit.

- MIC1: Selects microphone 1.
- MIC2: Selects microphone 2.
- MIC1+2: Selects both microphone 1 and microphone 2.

◇ Dimmer mode “DISP MODE”

The dimmer function dims function display and key illumination brightness. You can select a desired dimmer functioning mode to suits your preference.

- OFF: The dimmer function is OFF.
- AUTO: Automatically sets the dimmer according to the current lighting condition.
- MANUAL: Manually sets the dimmer in the Manual dimmer control “DISP MAN” item. (p. 21)

◇ Dimmer auto mode “DISP AUTO”

Sets the method to automatically control the dimmer brightness.*

*Displayed only when the Dimmer mode “DISP MODE” item in the Configuration menu is set to “AUTO.”

- PHOTO: Controls the dimmer brightness by using the light sensitive detector. (p. 2)
- EXT: Controls the dimmer brightness by using an external voltage.

◇ External dimmer control “DISP EXT”

Sets the maximum voltage for the external voltage dimmer control.

*Displayed only when the Dimmer auto mode “DISP AUTO” item in the Configuration menu is set to “EXT.”

- 14VDC: The maximum external voltage is 14 V DC.
- 28VDC: The maximum external voltage is 28 V DC.

◇ Dimmer brightness (Low) “DISP LOW”

Sets the minimum brightness level in the automatic adjustment range.*

*Displayed only when the Dimmer mode “DISP MODE” item in the Configuration menu is set to “AUTO.”

- OFF: Turn OFF the minimum dimmer brightness setting.
- 001 to 049: Sets the minimum dimmer brightness level to between 1 and 49.

◇ Dimmer brightness (High) “DISP HIGH”

Sets the maximum brightness level in the automatic adjustment range.*

*Displayed only when the Dimmer mode “DISP MODE” item in the Configuration menu is set to “AUTO.”

- 050 to 100: Sets the maximum dimmer brightness level to between 50 and 100.

◇ Dimmer response “DISP RESP.”

Sets the dimmer switching speed when selecting “AUTO” in the Dimmer mode “DISP MODE” item. (p. 23)

- STANDARD: Selects the normal switching speed.
- FAST: Selects the fast switching speed.

◇ USER-1 setting/USER-2 setting “U-1 ID SET”/“U-2 ID SET”

You can edit U-1 and U-2 channel tags (p.11) to the desired tag name.

- ① Push **[MEM]** to enter the U-1 or U-2 tag edit mode.
- ② Rotate **[DIAL]** to select a desired character.
- ③ Rotate **[O-DIAL]** to select the next input digit.
- ④ Repeat the steps ②–③ to input the desired tag name.
 - You can set three characters for the tag name.
- ⑤ Push **[MEM]** again to store the name, and exit the edit mode.

◇ External input “AUX IN”

Set the audio usage input from an external audio device. Refer to ‘INSTALLATION GUIDE’ for an external audio device connection details.

- OFF: The external audio is not used.
- ON: The external audio is output from the connected headset while no signal is received.
- INCOM: The external audio is output from the intercom 2’s headset when:
 - The intercom function is OFF.
 - While the intercom function is not in use.
 - While an audio signal is not input into the intercom 1’s microphone.

◇ External input gain “AUX MAX LVL”

Sets the maximum gain for audio usage input.

*Displayed only when the External input “AUX IN” item in the Configuration menu is set to “ON.”

- 0 dB: The maximum gain for audio usage input is 0dB.
- +3 dB: The maximum gain for audio usage input is +3dB.
- +6 dB: The maximum gain for audio usage input is +6dB.

◇ Intercom usable setting “INCOM MODE”

Sets the intercom using or not.

- ON: The intercom is usable.
- OFF: The intercom is unusable.

5 MENU MODE

◇ Time-Out-Timer “TIME OUT”

To prevent accidental prolonged transmission, the transceiver has a time-out-timer. The function inhibits continuous transmissions longer than the set time period.

- 020 to 240: Setting time-out-timer period from 20 seconds to 240 seconds in 10 second steps.

◇ Interlock “INTERLOCK”

If the transceiver is connected together with the other transceiver, the interlock function can prevent the transceiver from receiving or transmitting while the other transceiver is transmitting.

- ON: The interlock function is ON.
- OFF: The interlock function is OFF.

◇ Interlock mode “INTLOCK MODE”

Sets the desired function to be disabled by the interlock.

*Displayed only when the Interlock “INTLOCK” item in the Configuration menu is set to “ON.”

- TX INHIBIT: Transmission is disabled.
- RX MUTE: Audio output is disabled.
- BOTH: Both transmission and audio output are disabled.

NOTE: The interlock mode is not displayed when the “TX/RX INTERLOCK SW” item is set to “DISABLE.”
Ask your dealer for the “TX/RX INTERLOCK SW” setting details.

◇ Remote exchange “REM SWAP”

Sets the remote control (p. 16) to use the frequency exchange switch or not.

- OFF: The remote control for the frequency exchange switch is OFF.
- ON: The remote control for the frequency exchange switch is ON.

◇ Remote incom “REM INCOM”

Sets the remote control (p. 16) to use the intercom or not.

- OFF: The remote control for the intercom is OFF.
- ON: The remote control for the intercom is ON.

◇ Remote recall “REM RECALL”

Sets the remote control (p. 16) to use the recall switch or not.

- OFF: The remote control for the recall switch is OFF.
- ON: The remote control for the recall switch is ON.

◇ Memory clear “MEM CLEAR”

Select a desired item to be reset.

After the selection, hold down [MEM] for two seconds to reset the selected item’s contents.

- MENU: Reset the menu mode items setting to their defaults.
- MEMORY: Clear the stored memories except the weather memory channel.
- ALL: Reset the menu mode items setting to their defaults and clear the stored memories.

◇ **MB-53#03** MOUNTING BRACKET

For mounting the transceiver. The external speaker and microphone are included.



◇ **MBA-3** REAR PANEL ADAPTER

The rear panel adapter compatible with card edge connector.

◇ **PS-80#05** POWER SUPPLY

Provides convenient operation of the transceiver on the ground. A built-in speaker and microphone are included.

Dimensions: 200 (W) × 200 (H) × 300 (D) mm
 7.9 (W) × 7.9 (H) × 11.8 (D) in
 Outputs: 13.8 V DC / 6 A



The transceiver is not included.

Approved Icom optional equipment is designed for optimal performance when used with an Icom transceiver. Icom is not responsible for the destruction or damage to an Icom transceiver in the event the Icom transceiver is used with equipment that is not manufactured or approved by Icom.

Use of 8.33 kHz Channel Spacing of this radio is strictly prohibited and shall not be used in Canada.

◇ General

- Frequency range:

Channel spacing: 25 kHz	118.000 to 136.975 MHz
Channel spacing: 8.33 kHz	118.000 to 136.992 MHz
Weather channel*	161.650 to 163.275 MHz
- Channel spacing: 25 kHz or 8.33 kHz
- Frequency stability:

IC-A220	±5 ppm (−20°C to +55°C; −4°F to +131°F)
IC-A220E	±1 ppm (0°C to +40°C)
- Operating temperature: −20°C to +55°C;
−4°F to +131°F
- Antenna impedance: 50 Ω
- Number of memory channels: 20 regular memory channels
50 group memory channels
20 history memory channels
10 weather memory channels*
10 GPS memory channels
- Mode:

AM	6K00A3E/5K60A3E
FM*	16K0G3E
- Power supply requirement: 13.80 V/27.50 V DC
(negative ground)
- Dimensions: 160 (W)×34 (H)×271 (D) mm;
(projections not included) 6.3 (W)×1.3 (H)×10.7 (D) inches
- Weight (approximately): 1.0 kg; 2.2 lb

◇ Transmitter

- Output power:

IC-A220	8 W (Carrier power)
IC-A220E	6 W (Carrier power)
- Spurious emissions:

IC-A220	−60 dBc
IC-A220E	−36 dBm (harmonics) −46 dBm (non-harmonics)
- Microphone impedance: 600 Ω
- Modulation limiting:

IC-A220	70% (Maximum 98%)
IC-A220E	85% (Maximum 95%)

◇ Receiver

- Receive system: Double conversion
superheterodyne
- Intermediate frequencies: 1st 38.85 MHz
2nd 450 kHz
- Sensitivity:

IC-A220 AM	Less than 2 μV (pd) at 6 dB S/N
FM*	Less than 1.4 μV at 12 dB SINAD
IC-A220E	Less than −101 dBm at 12 dB SINAD

*For only U.S.A. version transceivers, receiving only.

- Selectivity (with 8.33 kHz channel spacing):
 - IC-A220 6 dB \pm 2.778 kHz
 - 60 dB \pm 7.37 kHz
 - IC-A220E 6 dB \pm 2.8 kHz
- Spurious response rejection:
 - IC-A220 More than 74 dB μ
 - IC-A220E More than 70 dB
- Audio output power:
 - External speaker 5 W into a 4 Ω load
 - Headphone 60 mW into a 500 Ω load

Measurements made in accordance with RTCA DO-186B for U.S.A. version transceivers, and EN 300 676 for European version transceivers.
 All stated specifications are subject to change without notice or obligation.

• Channel spacing: 25 kHz (Actual frequency is displayed.)

Operating Frequency (MHz)	Channel spacing (kHz)	Channel ID (Displayed Frequency)
118.0000	25	118.000
118.0250	25	118.025
118.0500	25	118.050
118.0750	25	118.075
118.1000	25	118.100

• Channel spacing: 8.33 kHz

Operating Frequency (MHz)	Channel spacing (kHz)	Channel ID (Displayed Frequency)
118.0000	8.33	118.005
118.0083	8.33	118.010
118.0167	8.33	118.015
118.0250	8.33	118.030
118.0333	8.33	118.035
118.0417	8.33	118.040
118.0500	8.33	118.055
118.0583	8.33	118.060
118.0667	8.33	118.065
118.0750	8.33	118.080
118.0833	8.33	118.085
118.0917	8.33	118.090
118.1000	8.33	118.105

These tables show just the display example between 118.0000 MHz and 118.1000 MHz. Not show all frequencies in the band are shown.

■ Country code list

• ISO 3166-1

	Country	Codes		Country	Codes
1	Austria	AT	18	Liechtenstein	LI
2	Belgium	BE	19	Lithuania	LT
3	Bulgaria	BG	20	Luxembourg	LU
4	Croatia	HR	21	Malta	MT
5	Czech Republic	CZ	22	Netherlands	NL
6	Cyprus	CY	23	Norway	NO
7	Denmark	DK	24	Poland	PL
8	Estonia	EE	25	Portugal	PT
9	Finland	FI	26	Romania	RO
10	France	FR	27	Slovakia	SK
11	Germany	DE	28	Slovenia	SI
12	Greece	GR	29	Spain	ES
13	Hungary	HU	30	Sweden	SE
14	Iceland	IS	31	Switzerland	CH
15	Ireland	IE	32	Turkey	TR
16	Italy	IT	33	United Kingdom	GB
17	Latvia	LV			

■ Disposal



The crossed-out wheeled-bin symbol on your product, literature, or packaging reminds you that in the European Union, all electrical and electronic products, batteries, and accumulators (rechargeable batteries) must be taken to designated collection locations at the end of their working life. Do not dispose of these products as unsorted municipal waste. Dispose of them according to the laws in your area.

	A	
AM squelch level.....		20
Automatic noise limiter		20
Auto squelch.....		22
	B	
Basic operation.....		4
Beep tone level.....		21
	C	
Channel tag.....		11
Clearing the memory contents		9
Configuration menu		19
Configuration menu items.....		22
	D	
Dimmer auto mode		23
Dimmer brightness		24
Dimmer mode		23
Dimmer response		24
Directly setting the frequency		6
Dualwatch.....		14
Dualwatch interval		22

	E	
Emergency frequency.....		15
Enter frequencies into memory channels		9
Entering channel names.....		10
Entering group names		10
External dimmer control		23
External input		24
External input gain.....		24
External input level		21

	F	
FM squelch level.....		20
Frequency display.....		21
Frequency step		16, 21
Front panel.....		1
Function display.....		3

	G	
GPS memory channel		13
Group memory		8
Group memory channel display.....		23

	H	
Headphone level.....		20
History memory channel.....		12

INDEX

I	
Intercom.....	16
Intercom 1 microphone audio input level.....	20
Intercom 1 squelch level.....	22
Intercom 2 microphone audio Input level.....	20
Intercom 2 squelch level.....	22
Intercom usable setting.....	24
Interlock.....	25
Interlock mode.....	25
L	
Lock function.....	15
Lock mode.....	20
M	
Manual dimmer control.....	21
Memory clear.....	25
Memory operation.....	7
Memory protection.....	22
Microphone 1 Gain.....	21
Microphone 2 Gain.....	21
O	
Options.....	26
P	
Priority watch.....	14
Priority watch interval.....	22
Protecting memory.....	13

R	
Rear panel.....	2
Receiving.....	5
Regular memory.....	8
Remote control.....	16
Remote exchange.....	25
Remote incom.....	25
Remote recall.....	25
S	
Settings menu items.....	20
Settings menu.....	18
Sidetone level.....	21
Specifications.....	27
Squelch settings.....	6
Squelch test.....	16
Squelch mode.....	20
T	
Time-Out-Timer.....	25
Transmitting.....	5
Transmitting microphone selection.....	23
U	
USER-1 setting/USER-2 setting.....	24
W	
Weather memory channel.....	12, 17

Count on us!

< Intended Country of Use >

- AT BE CY CZ DK EE
 FI FR DE GR HU IE
 IT LV LT LU MT NL
 PL PT SK SI ES SE
 GB IS LI NO CH BG
 RO TR HR

A-7210D-1EX-①
Printed in Japan
© 2015 Icom Inc.

Printed on recycled paper with soy ink.

Icom Inc.

1-1-32 Kamiminami, Hirano-ku, Osaka 547-0003, Japan