

MIZ[®]-22 Eddy Current Tester

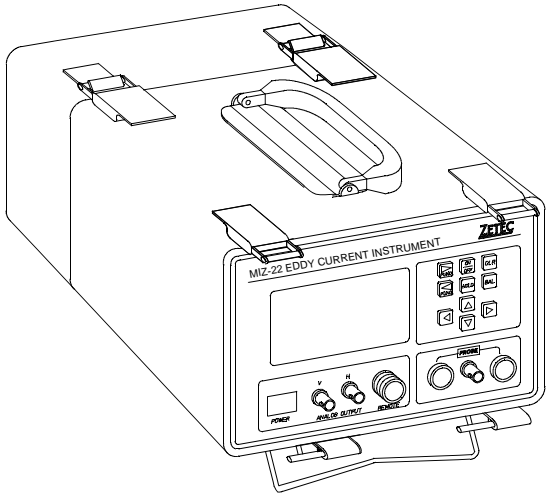

Operating Guide

28 April 2000

28 April 2000

© Zetec, Inc. 1992

ZETEC

*P.O. Box 140
Issaquah, Washington 98027-0140
U.S.A.
Tel (425) 392-5316
Fax (425) 392-2086*

Printed in the United States of America

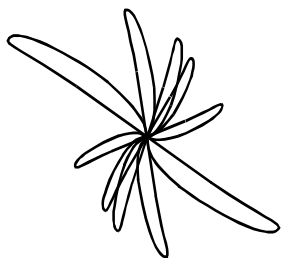

Table of Contents

1.0	General Description.....	1-1
1.1	Warranty.....	1-2
1.2	Copyright.....	1-3
1.3	Maintenance Agreement.....	1-4
1.4	Return Policy.....	1-4
2.0	System Description	2-1
2.1	Front Panel Controls	2-2
2.1.1	Display Screen.....	2-2
2.1.2	Function And Direction Arrows	2-4
2.1.3	ON/OFF Button.....	2-5
2.1.4	Clear Button.....	2-5
2.1.5	Balance Button	2-6
2.1.6	Hold Button.....	2-6
2.1.7	Probe Connectors.....	2-6
2.1.8	Remote	2-7
2.1.9	Analog Output.....	2-7
2.1.10	Power Receptacle.....	2-7

Table of Contents

2.2	Functional Block Diagram	2-8
2.3	Equipment Supplied	2-8
2.4	Optional Accessories	2-9
2.4.1	Probes	2-9
2.4.2	Rotating Probe Gun	2-10
2.4.3	Equipment Cases	2-10
2.5	Specifications	2-11
2.5.1	Conductivity Feature	2-12
2.5.2	Frequency Range	2-14
2.5.3	Phase	2-14
2.5.4	Gain Adjustment Range	2-14
2.5.5	Display	2-15
2.5.6	Memory	2-15
2.5.7	Alarm	2-16
2.5.8	Filters	2-16
2.5.9	Signal Mixing	2-17
2.5.10	Inputs	2-17
2.5.11	Outputs	2-17
2.5.12	Power Requirements	2-18
2.5.13	Battery Pack	2-18
2.5.14	Dimensions	2-18
2.6	Environmental	2-19
2.6.1	Operating Temperature Range	2-19
2.6.2	Storage Temperature Range	2-19
2.6.3	Humidity	2-19
2.6.4	Lighting	2-19
2.7	Hazardous Locations Usage	2-20
2.7.1	Hazardous Locations	2-20
2.7.2	U.L. Approved Accessories	2-21

Table of Contents

3.0	Installation	3-1
3.1	Unpacking	3-1
3.2	Power Requirements.....	3-2
3.2.1	Power Connector	3-3
3.2.2	Storage Battery.....	3-3
3.3	Turning On Unit and Backlight	3-4
3.4	Front Panel Connections.....	3-5
3.4.1	Probe Connectors.....	3-5
3.4.2	Remote Connector.....	3-7
3.4.3	V and H Connectors	3-9
3.4.4	Power Connector	3-9
4.0	Operation	4-1
4.1	Turning On Unit and Backlight	4-2
4.2	Instrument Setup.....	4-4
4.2.1	Setup	4-5
4.2.2	Store-and-View Screen Image Buffer	4-8
4.2.3	Display Parameters	4-12
4.2.4	Frequency.....	4-14
4.2.5	Phase.....	4-16
4.2.6	Gain	4-18
4.2.7	V/H Scaling.....	4-20
4.2.8	Filters.....	4-22
4.2.9	Alarm	4-24
4.2.10	Data Buffer.....	4-26
4.2.11	Mix Menu	4-30
	MIX-1.....	4-32
	MIX-2.....	4-33

Table of Contents

4.2.12	Probe Type	4-34
4.2.13	Auto Clear and Screen A/B.....	4-35
4.2.14	Printer Control.....	4-39
4.3	Special Features	4-40
4.3.1	Digital Conductivity Measurement	4-40
4.3.2	Nonconductive Coating Thickness Measure- ment.....	4-57
4.4	Auxiliary Features	4-59
4.4.1	Battery Voltage Readout.....	4-59
4.4.2	Automatic Turn-Off.....	4-59
4.4.3	Battery Pack	4-60
4.4.4	Analog Outputs.....	4-62
4.4.5	Computer Interface	4-62
4.4.6	Probe Gun Interface	4-68
4.4.7	Self-Test.....	4-70
5.0	Application Examples	5-1
5.1	Test Design Considerations	5-1
5.2	Surface Crack Example	5-5
5.3	Aircraft Skin Corrosion Example	5-8
5.4	Alloy Sorting Example	5-11
5.5	Fastener Hole Example.....	5-14
5.6	Countersink Example	5-17
5.7	Triggered Sweep with Filter Example.....	5-20

Table of Contents

5.8	C-scan Example.....	5-28
5.9	Signal Mixing Example.....	5-33
5.9.1	Mixing Out Lift-Off Signals.....	5-35
5.9.2	Mixing Out Varying Spacing.....	5-43
5.9.3	Tube Support Signal Suppression Mix	5-46
5.10	Conductivity Measurement Example	5-50
5.10.1	Geometry.....	5-50
5.10.2	Temperature.....	5-51
5.10.3	Frequency Selection.....	5-51
5.11	Direct Coating Thickness Measurement Example	5-59
5.12	Sample Setup Data Worksheet.....	5-60
	Index	I-1

List of Figures

Figure 2-1.	Front Panel Controls	2-3
Figure 2-2.	Functional Block Diagram	2-8
Figure 3-1.	Battery Pack Top Assembly Detail.....	3-2
Figure 3-2.	Front Panel Connections.....	3-5
Figure 4-1.	ON/OFF Control.....	4-3
Figure 4-2.	Display Menu	4-5
Figure 4-3.	Setup Control	4-7
Figure 4-4.	Screen Image Buffer Menu Selection	4-8
Figure 4-5.	View Buffer Mode.....	4-11
Figure 4-6.	Display Parameters.....	4-12
Figure 4-7.	Frequency Control.....	4-15
Figure 4-8.	Phase Control	4-17
Figure 4-9.	Gain Control.....	4-19
Figure 4-10.	V/H Ratio Control	4-21
Figure 4-11.	Filter Control.....	4-23
Figure 4-12.	Alarm Control	4-25
Figure 4-13.	Data Buffer	4-27
Figure 4-14.	Expand/Reduce Strip Chart	4-28
Figure 4-15.	Mix Menu.....	4-30
Figure 4-16.	Probe Type.....	4-34
Figure 4-17.	Auto Clear Control.....	4-36
Figure 4-18.	Screen A/B	4-38
Figure 4-19.	Default % IACS Display	4-43
Figure 4-20.	T/D- \ast -SP Reflection Probe.....	4-44
Figure 4-21.	SET# Adjustment	4-48
Figure 4-22.	Shim Value Adjustment.....	4-49
Figure 4-23.	Calibration Mode	4-51
Figure 4-24.	Calibration with Shim	4-53
Figure 4-25.	Probe in Air Calibration Point.....	4-54
Figure 4-26.	Drift Compensation	4-56
Figure 4-27.	Nonconductive Coating Thickness Measurement Display	4-58
Figure 4-28.	Self-Test Display Example.....	4-72
Figure 5-1.	Surface Crack Indication.....	5-7
Figure 5-2.	Corrosion Indication	5-10
Figure 5-3.	Alloy Sorting Example	5-13

List of Figures

Figure 5-4.	Fastener Hole Flaw Indication.....	5-16
Figure 5-5.	Countersink Flaw Indication.....	5-19
Figure 5-6.	Absolute Coil Signal without Filter.....	5-22
Figure 5-7.	Absolute Coil Signal with FILTER 1.....	5-24
Figure 5-8.	Absolute Coil Signal with FILTER 2.....	5-25
Figure 5-9.	Differential Coil Signal without Filter.....	5-26
Figure 5-10.	Differential Coil Signal with FILTER 1.....	5-27
Figure 5-11.	C-scan of Flaw Indications.....	5-31
Figure 5-12.	Buffered Data.....	5-32
Figure 5-13.	Set FREQ1.....	5-36
Figure 5-14.	Set FREQ2.....	5-37
Figure 5-15.	Two-Frequency Mix Setup.....	5-37
Figure 5-16.	Lift-Off Signal.....	5-38
Figure 5-17.	Mix Residual.....	5-41
Figure 5-18.	MX Channel Display.....	5-42
Figure 5-19.	Response To Varying Gap Spacing Between Layers.....	5-44
Figure 5-20.	Flaw Response with Varying Gap Spacing.....	5-45
Figure 5-21.	Flaw Response on Mix.....	5-45
Figure 5-22.	Tube Support Suppression Mix.....	5-48
Figure 5-23.	100% Thru-Wall Signal at 400 kHz.....	5-49
Figure 5-24.	Default %IACS Display.....	5-54
Figure 5-25.	Calibration Display.....	5-55
Figure 5-26.	Shim Value Display.....	5-56
Figure 5-27.	Air Value.....	5-58

List of Tables

Table 2-1.	Battery Life with Accessories	2-18
Table 2-2.	U.L. Approved Probe List	2-21
Table 2-3.	U.L. Approved Accessories	2-24
Table 3-1.	Probe Connectors	3-6
Table 3-2.	Remote Connector Pin-Out	3-8
Table 4-1.	Nominal Electrical Conductivity of Various Materials	4-41
Table 4-2.	Power-Up Commands	4-64
Table 4-3.	FORTH Commands	4-66
Table 5-1.	Requirements for Surface Crack Test	5-5
Table 5-2.	Requirements for Aircraft Skin Corrosion Test	5-8
Table 5-3.	Requirements for Alloy Sorting Example	5-11
Table 5-4.	Requirements for Fastener Hole Example	5-14
Table 5-5.	Requirements for Countersink Test Example	5-17
Table 5-6.	Requirements for Triggered Sweep with Filter	5-20
Table 5-7.	Requirements for C-scan Example with Scanner	5-29
Table 5-8.	Requirements for Mixing Out Lift-Off Signals	5-35
Table 5-9.	Requirements for Mixing Out Varying Spacing	5-43
Table 5-10.	Requirements for Mixing Out Tube Support Signal	5-46
Table 5-11.	Instrument Settings for Tube Support Suppression Mix	5-47
Table 5-12.	Requirements for Conductivity Measurement	5-52

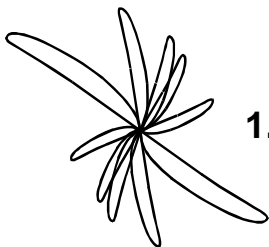

1.0 General Description

This operating guide is designed to familiarize the user with the specifications, operation, and applications of the MIZ[®]-22 Eddy Current Instrument.¹ We recommend reading the entire guide through at least once, after which the Table of Contents and Index can be used for a quick-reference to any specific subject.

A technical manual is available for the MIZ-22 at an additional charge. For more information about the contents or availability of this manual, please contact our customer service department.

Zetec, Inc. would like to provide its product users with the most useful manuals possible. We appreciate your comments and suggestions to help in achieving this goal.

1. MIZ is a registered trademark of Zetec, Inc.

1.1 Warranty

The Zetec products listed in the current equipment catalog are warranted for a period of one (1) year from date of shipment to original purchaser. They are warranted to conform to Zetec specification and to be free from defects in material or manufacture when used with Zetec equipment. Liability is limited to servicing or replacing defective parts, except those items which would require periodic replacement due to normal wear during use. This does not include calibration nor minor maintenance as outlined in Zetec Operating Manuals.

In no event shall Zetec, Inc. be liable under any circumstances for loss of profits or other contingent, consequential, or special damages. Units are to be returned transportation prepaid by the buyer, and returned to buyer freight collect.

This warranty shall not apply to products which have been subjected to misuse, improper installation, repair, alteration, neglect, accident, inundation, fire, or operation outside published maximum ratings.

1.2 Copyright

The information contained in this document is subject to change without notice. Neither Zetec, Inc. nor any person acting on behalf of Zetec, Inc. makes any warranty, expressed or implied, with respect to the use of any information, apparatus, method or process disclosed in this document. Zetec, Inc. shall not be liable for errors contained herein or for incidental or consequential damages in connection with the furnishing, performance, or use of this material.

This document contains proprietary information which is protected by copyright. All rights are reserved. No part of this document may be reproduced, transmitted, transcribed, stored in a retrieval system, or translated into any language or computer language, in any form or by any means, electronic, mechanical, magnetic, optical, chemical, manual or otherwise, without the express prior written permission of:

Zetec, Inc.

PO Box 140

Issaquah, WA 98027

©Copyright Zetec, Inc. 1992, 1993, 1995, 1996

1.3 Maintenance Agreement

Zetec's liability is limited to servicing or replacing defective parts, except those items which would require periodic replacement due to normal wear during use. This does not include calibration nor minor maintenance as outlined in Zetec Operating Manuals.

1.4 Return Policy

When you receive the MIZ-22 instrument, check for carton damage. Note any signs of damage and or appropriate shipping forms. If the shipping carton is damaged upon receipt, request the carrier's agent be present when the item is unpacked. If concealed damage is found immediately file a claim with the carrier.

The next section of this guide is a complete description of the MIZ-22 Eddy-Current Instrument.

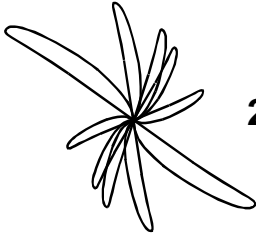

2.0 System Description

The portable MIZ-22 is a versatile eddy current instrument designed for defect detection, thickness measurement, direct conductivity measurement, and sorting by metallurgical differences (i.e., conductivity or permeability changes of ferrous or nonferrous materials).

This compact tester combines signal processing circuitry, display, and alarm circuits into one lightweight sealed unit. It can be operated on battery or AC power, and it is U.L. listed for use in hazardous locations.

The liquid crystal display on the MIZ-22 presents the phase and amplitude vectors of the eddy current signal as a combined, two-dimensional pattern. The design incorporates a wide gain range and flexible alarm circuitry. Any degree of signal analysis is possible from a simple go/no-go comparison between test parts and reference sample signals, to in-depth investigation of small variations in metallurgy.

The V and H outputs permit the user to record analog test data. The Remote connector is an RS-232 serial interface, which allows external computer control and transmission of data to a printer or terminal.

The sealed front panel controls are designed for easy operation. Instrument settings are indicated on the digital LCD.

2.1 Front Panel Controls

Reference figure 2-1 for the location of each front panel control described in the following sections.

2.1.1 Display Screen

The liquid crystal display (LCD) is comprised of 256 horizontal and 128 vertical picture elements, or *pixels*. From left to right, the first 192×128 pixels are used for the data display area. This first area is overlaid with a grid of 6×9 major divisions. Each division is 0.375" square, and contains 21×21 pixels. Special messages, such as the visual alarm indicator and battery voltage, are displayed in this area.

On the right side of the display, a 64×128 pixel area is the function menu.

Figure 2-1. Front Panel Controls

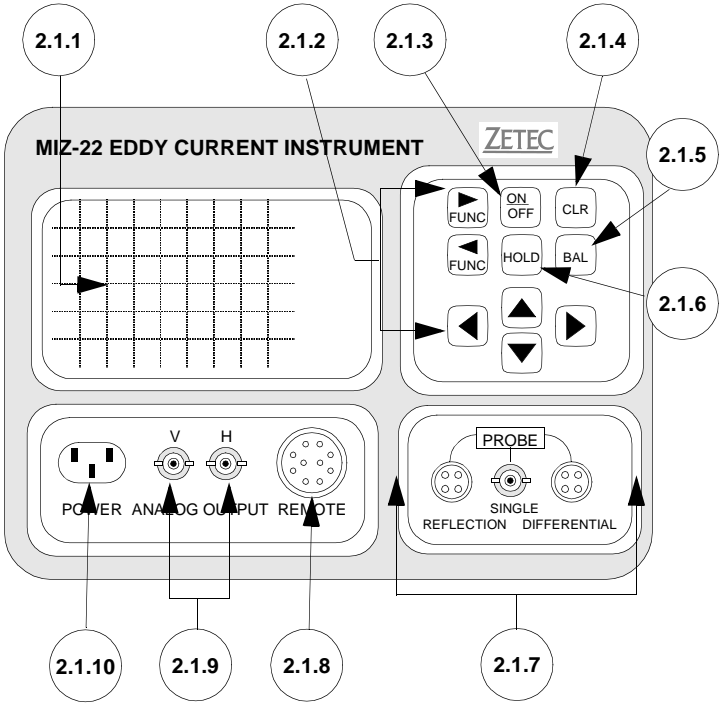

KEY

- 2.1.1 Display Screen
- 2.1.2 Function and Directions Arrows
- 2.1.3 ON/OFF Button
- 2.1.4 CLEAR Button
- 2.1.5 BALance Button
- 2.1.6 HOLD Button
- 2.1.7 PROBE Connectors
- 2.1.8 REMOTE Connector
- 2.1.9 ANALOG OUTPUT
- 2.1.10 POWER Receptacle

2.1.2 Function And Direction Arrows

The keypad provides ten membrane-style switches. Four of the keys, ON/OFF, BAL, CLR, and HOLD operate once for each key press. The two FUNC keys, and the four direction arrows, UP, DOWN, LEFT, RIGHT, have a repeat function that is enabled whenever the key is held in for more than a brief moment.

The FUNC keys provide movement of the inverse video cursor through the various setup parameters. The top key moves the cursor up, and, in the MIX MENU field, to the right. The bottom key moves the cursor down, and, in the MIX MENU field, to the left.

The direction arrows have different functions, depending on the position of the cursor. They are used variously to turn functions on and off, to change parameters, to enter configuration names, and to manipulate the alarm area. When the cursor is moved entirely out of the setup menu, the direction arrows are disabled. The direction arrows are explained in detail in the descriptions of the specific setup items.

2.1.3 ON/OFF Button

The ON/OFF button is used to turn the MIZ-22 on and off. To turn the MIZ-22 on, hold the ON/OFF switch in for approximately one second, then release. The power turns on when the switch is released.

The ON/OFF button also controls the backlight. After the instrument is powered up, a brief tap on the button toggles the backlight on or off.

To turn the unit off, press the ON/OFF switch and hold it for approximately one second. Both the instrument and backlight turn off.

2.1.4 Clear Button

The CLR button can be used at any time to erase the test data area of the screen except when the HOLD function is activated. The setup menu on the right-hand side is unaffected.

2.1.5 Balance Button

The balance button causes the instrument to adjust the horizontal and vertical amplifiers of the analog section to approximately zero volts and positions the signal dot to the selected position on the screen.

2.1.6 Hold Button

Pressing the HOLD button causes the MIZ-22 to stop acquiring new data. While in the HOLD mode, the instrument's memory retains the last six seconds of data in the single frequency mode and ten seconds in the dual frequency mode. The operator can select any portion of this data to be displayed on the screen.

2.1.7 Probe Connectors

The MIZ-22 provides probe connectors for reflection (driver-pickup), single (absolute), and differential type probes.

2.1.8 Remote

The REMOTE connector is designed to control the Zetec Rotating Probe Gun, although other rotating devices may be used.

2.1.9 Analog Output

The V and H ANALOG OUTPUTS provide a voltage corresponding to the vertical and horizontal position of the data on Display 1 only.

2.1.10 Power Receptacle

This receptacle is used with a power cord when operating the MIZ-22 on AC power instead of battery power.

2.2 Functional Block Diagram

Reference figure 2-2 for a complete block diagram of the MIZ-22.

Figure 2-2. Functional Block Diagram

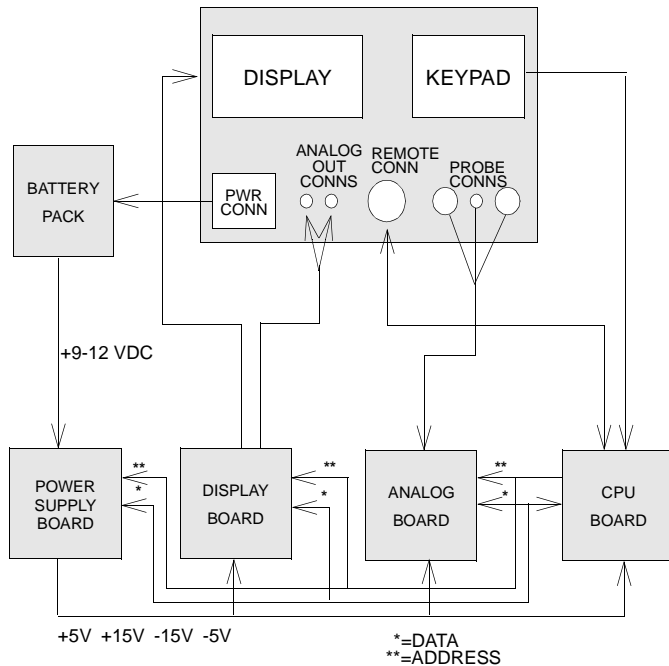

2.3 Equipment Supplied

The MIZ-22 is supplied as a complete instrument, with detachable line cord and operating guide. A foam padded shipping case with handle is optional. At least one

probe is required for eddy current inspection with the MIZ-22. Probes and coils must be ordered separately since the proper configuration and type must be selected for each testing application.

2.4 Optional Accessories

The MIZ-22 has optional accessories available such as probes, rotating probe guns, and shipping cases.

2.4.1 Probes

Zetec offers a full line of probes suitable for surface flaw detection, deep penetration work, fastener hole inspection, tube testing, conductivity measurement, and more. Consult with our Applications Department to determine the best probe for your situation.

The general purpose nature of the circuitry also makes the MIZ-22 compatible with probes from most other manufacturers.

2.4.2 Rotating Probe Gun

The Zetec rotating probe gun is specifically designed for use with the MIZ-22. It offers two speeds, remote instrument control, and can be supplied with probes in a variety of diameters.

With the instrument's sampling rate of 1250 samples per second, the MIZ-22 supports the Zetec High-Speed Scanner.

2.4.3 Equipment Cases

Two custom-designed cases are available—a hard shell, foam-lined case for shipping the instrument or a lightweight padded bag with shoulder strap, for ease of carrying the unit. The second case also allows the operator to view and operate the instrument without any unpacking.

2.5 Specifications

The MIZ-22 is a portable eddy current instrument designed for defect detection, thickness gauging, and measurement of the conductivity of electrically conductive materials. Two simultaneous frequencies, signal mixing, data filtering, and special display capabilities enhance the MIZ-22's ability to detect defects.

While using one frequency, this instrument has a maximum sampling rate of 1250 samples per second to increase its production rate and quality of data. However, while using two frequencies, the maximum sample rate is 400 samples per second.

The instrument utilizes a liquid crystal display for both presentation of *X-Y impedance plane* data and for read-out of operating parameters. The rugged aluminum housing and waterproof construction make the instrument suitable for use under a variety of inclement conditions, as well as in the laboratory.

The high-gain analog inputs and microprocessor-based design provide excellent sensitivity and stability in the signal processing of the unit. Many additional features, such as electronic balancing,

printer interface, triggered sweep, and analog outputs are included in the instrument. Even with all this performance and versatility, the overall design goal of easy operation allows the new operator to quickly learn the system.

2.5.1 Conductivity Feature

The MIZ-22 has three conductivity measurement frequencies—60, 120, and 240 kHz.

- **Conductivity Measurement**

Accuracy—Instrument accuracy is certified as:

Class I: $\pm 0.5\%$ IACS—materials with conductivity range between 0.9 and 25% IACS (0.5 and 14.5 MS/m).

Class II: $\pm 0.5\%$ IACS—materials with conductivity range between 16 and 60% IACS (9.5 and 35 MS/m)

Class III: $\pm 1\%$ IACS—materials with conductivity range between 60 and 102% IACS (35 and 70 MS/m)

Combined instrument and standard accuracy above 15% IACS is $\pm 1\%$ of value; below 15% is $\pm 3\%$ of value.

- **Conductivity Measurement Error** (caused by lift-off)— $\pm 1\%$ up to three mils.
- **Lift-Off Measurement Accuracy**— ± 0.5 mil when measuring a coating thickness on material equal to or greater than 3.5% IACS; ± 2.0 mils when less than 3.5% IACS.
- **Drift Compensation**—The MIZ-22 is certified to drift less than 0.5% IACS over a 15-minute period in a stable environment. After a 15-minute warm-up period, complete the calibration routine and then check the instrument every fifteen minutes during a work session. Using the standard that is closest in value to the material you are testing, rnull the instrument as necessary.
- **Temperature Considerations**—The temperature of the instrument, standard, and test piece must be within 2°C (3.6°F) to avoid introducing measurement errors.



If the instrument is used before a warm-up period, check the nearest standard before making a measurement, and rnull the instrument when necessary.

2.5.2 Frequency Range

- **Frequency 1**—Adjustable from 50 Hz to 2 MHz.
- **Frequency 2**—Adjustable from 100 Hz to 1 MHz.

2.5.3 Phase

- Manually adjustable in 1-degree steps from 0 to 359 degrees.

2.5.4 Gain Adjustment Range

- 0 to 49.5 dB in 1/2 dB steps.
- Ratio of vertical to horizontal amplitude adjustable from 01:50 to 50:01.

2.5.5 Display

- 128 × 256 pixel Liquid Crystal Display.
- Viewing area 2.3" × 4.6" (5.84 × 11.68 cm).
- Contrast ratio minimum 12:1.
- Built-in heater (auto turn-on below 40°F/4.4°C) and backlight.
- Data can be displayed in three modes—triggered sweep, C-scan, and X-Y impedance plane modes.

2.5.6 Memory

- **Non-volatile** (data retained with power off).
 - Stores 100 setups.
 - Stores 10 screen images for viewing or printing.
- **Volatile** (data not stored with power off).
 - Temporary 6.5-second buffer memory available in HOLD mode allows on-screen manipulation of data.
 - Two display screens can be alternately accessed for comparison of separate data.

2.5.7 Alarm

- An alarm box is provided for either Display 1 or Display 2.
- Any required position or size can be set.
- Either the inside or outside gated area can be set to trigger.
- Audio and visual indicators provided.

2.5.8 Filters

Filters allow for separation of desired test data from the effects of lift-off and motion.

- **Filter 1**—1st Derivative Differential
This filter is generally used with differential coils. Filter is adjustable in 15 steps from 01 to 15.
- **Filter 2**—2nd Derivative Differential
Primarily used with an absolute coil, this filter allows for a more natural presentation of the flaw signal. Filter is adjustable in 15 steps from 01 to 15.

2.5.9 Signal Mixing

- **MIX-1**—This method provides a least squares data suppression mix.
- **MIX-2**—As an alternative to MIX-1, this method provides a data enhancement mix in addition to the suppression function.

2.5.10 Inputs

- Separate probe connectors are provided for differential, single (absolute), and reflection (driver-pickup) type probes.
- Remote connector provides RS-232 data bus for computer-controlled setups, external sweep trigger input for rotating probe, and remote balance and hold controls.

2.5.11 Outputs

- Vertical and horizontal analog outputs available on BNC connectors for chart recorders and other instruments.
- Remote connector provides RS-232 data bus for screen dumps to printer and transfer of test data to computer. External alarm indicator and vertical analog signal are also present on the remote connector.

2.5.12 Power Requirements

- AC input, 115/230 VAC, 50/60 Hz, 33-watt maximum.
- Switch selectable on inner lid of battery pack.

2.5.13 Battery Pack

- Contains nine NI-CAD D cells with built-in charger.
- Under full charge, the unit operates for approximately 8 hours without any accessories turned on. However, battery life is reduced while accessories are operating as listed in table 2-1.

Table 2-1. Battery Life with Accessories

Accessory	Battery Life Reduction
Backlight	1.5 hours
Heater (below 40°F)	0 to 2 hours, depending on ambient temperature
Zetec Probe Gun	1.5 hours

2.5.14 Dimensions

- **Size**
–6.5” high × 10.5” wide × 14.5” deep
–16.51 cm × 26.67 cm × 36.83 cm
- **Weight**
–20 pounds
–9.072 kg

2.6 Environmental

Several environmental factors may affect the operation of the MIZ-22. Reference the following sections for more information about these factors.

2.6.1 Operating Temperature Range

- 20° to 125°F (-6.7° to 51.7°C)

2.6.2 Storage Temperature Range

- 0° to 140°F (-17.7° to 60°C)

2.6.3 Humidity

- 0 to 100 percent.

2.6.4 Lighting

- Internal backlight allows operation in total darkness.
- Display maintains full contrast in brightest sunlight.

2.7 Hazardous Locations Usage

The MIZ-22 is Underwriters Laboratories approved for use in Class I Group D Hazardous Locations, which include aircraft environments where explosive fuel vapors may be present. Essentially, this approval means that under battery operation, there is no failure mechanism present in the instrument that will cause ignition of such vapors.

Rating and warning labels are on the top surface of the unit and on the inner lid of the battery pack. The labels concern both general usage and hazardous environments. For operator safety, all of these precautions should be followed.

2.7.1 Hazardous Locations

When operating specifically in hazardous locations, only accessories (probes or other items connected to the front panel) that have been approved by U.L. should be used. The evaluation is based on the measurement of the inductance and resistance of the device.

Items presently approved are various eddy current probes and accessories. Other items will be added to the list as required. Contact Zetec, Inc. to arrange a review of any accessory for which you desire hazardous location approval.

2.7.2 U.L. Approved Accessories

The following tables are lists of the approved probes and accessories as of April 1988.

Table 2-2. U.L. Approved Probe List

Part Number	Type	Catalog Number
Z-144-P	Pencil	910-6000
Z-145-P	Pencil	910-6010
Z-146-P	Pencil	910-6020
Z-147-P	Pencil	910-6030
Z-148-P	Pencil	910-6040
Z-145-P/S	Pencil	N/A
P-3-ADJ	Pencil	914-6120
P-9025-ADJ	Pencil	912-6400
P-9031-ADJ	Pencil	912-6410
Z-145-PRA	Pencil	910-8100
Z-1995-GCD	Pencil	N/A
PF9025-1X2	Pencil	N/A
PF9025-2X1	Pencil	N/A

Table 2-2. U.L. Approved Probe List (Cont.)

Part Number	Type	Catalog Number
PF-2	Pencil	N/A
PFC9025-3	Pencil	N/A
PFC-3	Pencil	N/A
PF9025-1X2H	Pencil	N/A
PF9025-2X1H	Pencil	N/A
PF4550-2XH	Pencil	N/A
10-11605REF COIL	Reference	N/A
Z2-125-**	Bolthole	920-8200
Z2-125-**-2	Bolthole	920-8300
MBH/S-*.125	Rotating Bolthole	921-8400
Z-4500-375	Spot	925-8500
Z-600-375	Spot	925-8502
Z-100-125	Spot	925-8504
Z-25-125	Spot	925-8506
Z-5-125	Spot	925-8508
Z-3-125	Spot	925-8510
2-351009	Shielded Spot	N/A
550-5000	Low Freq Spot	927-8650
SP-4500-375	Low Freq Spot	N/A
DP-750-SP	Reflection Spot	930-8820
DP-500-SP	Reflection Spot	930-8810
DP-270-SP	Reflection Spot	930-8802
DP-Differential	Reflection Spot	N/A
1000/62000	Low Freq Ring	N/A
DP-310-R	Reflection Ring	931-0020

2.0 Product Description
Hazardous Locations Usage

Table 2-2. U.L. Approved Probe List (Cont.)

Part Number	Type	Catalog Number
DP-625-R	Reflection Ring	931-0080
RR0112-2	Reflection Ring	N/A
DT20P	Pencil	909-0020-000
DT30PS	Pencil	909-0030-000
39DT106	Pencil	909-0106-000
39DT136	Pencil	909-0136-000
9DT45P	Pencil	909-0045-000
9DT61S	Pencil	909-0061-000
DT21P	Pencil	909-0021-000
DT31PS	Pencil	909--0031-000
39DT107	Pencil	909-0107-000
39DT137	Pencil	909-0137-000
9DT46P	Pencil	909-0046-000
9DT62S	Pencil	909-0062-000
DT22P	Pencil	909-0022-000
DT32PS	Pencil	909-0032-000
39DT108	Pencil	090-0108-000
39DT138	Pencil	909-0138-000
9DT47P	Pencil	909-0047-000
9DT63S	Pencil	909-0063-000
A-ADJ/MBH/F-**	Bolthole	921-8427-000

Table 2-2. U.L. Approved Probe List (Cont.)

Part Number	Type	Catalog Number
A-ADJ/MBH/F/HF-**	Bolthole	921-8428-000
A-ADJ/MBH/SC-**	Bolthole	921-8425-000
A/MBH/S-SC-**	Bolthole	921-8417-000
A/MBH-SC-**	Bolthole	921-8420-000
A-ADJ/MBH/HSC-**	Bolthole	921-8426-000
A/MBH-HSC-**	Bolthole	921-8421-000
A/SC-* -BH Manual	Bolthole	921-8424-000
90-degree BK Drop Point		D#4948-1-A

Table 2-3. U.L. Approved Accessories

Catalog Number	Accessory
2000-02-01	Rotating Bolthole Scanner

The next section of this manual is about the installation of the MIZ-22 instrument.

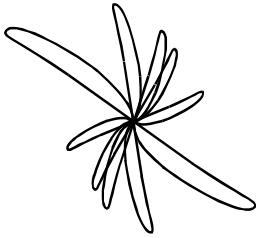

3.0 Installation

This section of the operating guide starts with unpacking the instrument after it arrives, and then goes through the system setup until it is ready for operation.

3.1 Unpacking

Use the following steps to unpack the MIZ-22 when it arrives.

- step 1 Carefully remove the MIZ-22 from the shipping carton, by grasping the carrying handle on the top, and place the instrument on an appropriate work surface with the handle facing upward.
- step 2 Reach under the bottom of the instrument and pull the leg found there all the way forward. This angles the front display to the best advantage for use.
- step 3 Remove the front cover by unfastening the two buckles on the top and sliding it to the left.

3.2 Power Requirements

The MIZ-22 can be operated on battery or AC power. Before plugging the instrument into the AC line, assure that the voltage select switch, located on the inner lid of the battery pack, is placed in the proper setting (refer to figure 3-1 to reference the location of the voltage select switch).

Figure 3-1. Battery Pack Top Assembly Detail

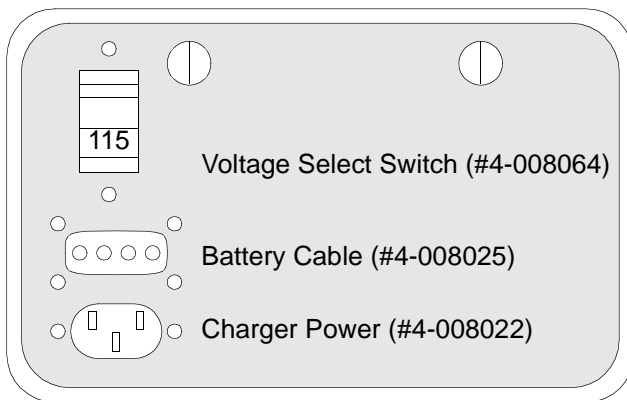

3.2.1 Power Connector

The power connector connects with a standard instrumentation line cord to provide AC voltage for battery charging and instrument operation. The third wire of the line cord should be properly connected to earth ground. The power source may be 115 or 230 VAC, 50 or 60 Hz. Plug the power cord onto the front panel using the receptacle marked POWER, and then connect to an appropriate power source.

3.2.2 Storage Battery

The storage battery contains a nominal 10 VDC battery pack comprised of 9 four-ampere-hour size D cells, in series. The battery life is good for at least 1000 recharge cycles when used according to manufacturer's specifications.

It is always a good idea to have a spare battery pack on charge during a work session. Spare battery packs are available from Zetec.

3.3 Turning On Unit and Backlight

Use the following steps for turning on the MIZ-22 and its backlight.

- step 1** Before plugging the instrument into the AC line, assure that the voltage select switch, located on the inner lid of the battery pack is placed in the proper setting (refer to figure 3-1).

- step 2** To turn the MIZ-22 on, hold the ON/OFF switch in for approximately 1 second, then release. The power turns on when the switch is released. At this time, the instrument goes through a brief self-test cycle, after which the setup menu will be displayed on the screen. The self-test operates properly only if a probe is not attached to the single connector. Refer to section 4.4.7 on page 4-70 for more details regarding the self-test.

- step 3** The ON/OFF button also controls the backlight. After the instrument is powered up, a brief tap on the button toggles the backlight on or off. The unit consumes about 25% more power when the backlight is on, so for battery operation, it should be used only when required.

- step 4 To turn the unit off, press the ON/OFF switch and hold for approximately one second. Both the instrument and backlight turn off.

3.4 Front Panel Connections

The diagram in figure 3-2 illustrates the location of the connectors on the front panel.

Figure 3-2. Front Panel Connections

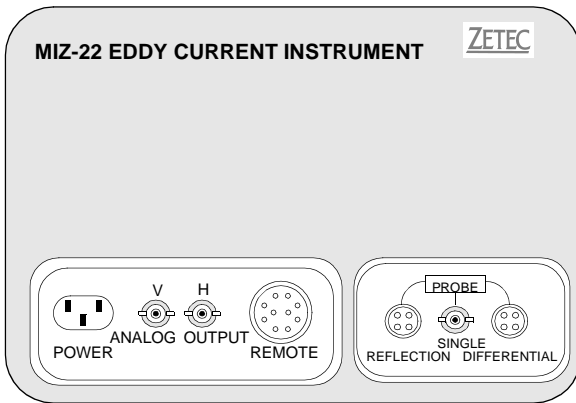

3.4.1 Probe Connectors

The MIZ-22 provides probe connectors for reflection (driver-pickup), single (absolute), and differential type probes.

The probe connectors are wired as listed in table 3-1.

Table 3-1. Probe Connectors

Probe Connector	Location	Function
Reflection	Pin A	Drive Coil
	Pin B	Test Coil
	Pin C	Test Return
	Pin D	Drive Return
Single	Center	Test Coil
	Ring	Test Return
Differential	Pin A	Reference Coil
	Pin B	Test Coil
	Pin C	Test Return
	Pin D	Reference Return

3.4.2 Remote Connector

The *REMOTE* connector provides signals for the RS-232C computer interface and for the Zetec rotating probe gun. Also available are the vertical analog output and alarm indicator signals for use with external indicator devices.

The *REMOTE* connector pin-out and corresponding signal levels are as listed in table 3-2.

Table 3-2. Remote Connector Pin-Out

Pin	Signal	Logic Level	Maximum
1	Ground		
2	Nominal	+10 VDC Power	750 mA
3	Alarm Out	TTL Level	2 mA
4	Analog Out	± 2.5 V Range	5 mA
5	Sweep Trig In	0 V True	12 V
6	Spare Input	TTL Level	5 V
7	Balance In	0 V True	5 V
8	RS-232 In		± 12 V
9	Hold In	0 V True	5 V
10	RS-232 Out		5 mA

3.4.3 V and H Connectors

The V (vertical) and H (horizontal) outputs provide an analog representation of the current location of the DISPLAY1 data dot on the screen. The connectors are specified as follows:

V— $\pm 2.5\text{V}$ 5mA max

H— $\pm 3.8\text{V}$ 5mA max

3.4.4 Power Connector

The power connector connects with a standard instrumentation line cord to provide AC voltage for battery charging and instrument operation. The third wire of the line cord should be properly connected to earth ground. The power source may be 115 or 230 VAC, 50 or 60 Hz. A line voltage selector switch is provided on the inner lid of the battery pack. It must be placed in the proper setting before the instrument is connected to the AC line.

The next section of this guide is about the operation of the MIZ-22 instrument.

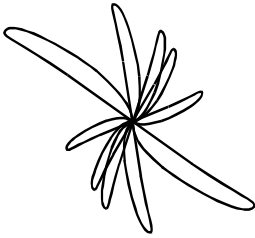

4.0 Operation

The MIZ-22 combines a dual display, signal processing circuitry, and alarm circuits into one lightweight sealed unit. It can be operated on battery or AC power.

If you are familiar with Zetec's MIZ-20A, you will find the MIZ-22 is an enhanced version. With two simultaneous frequencies, signal mixing, data filtering, and special display capabilities, the MIZ-22's capability to detect defects is improved.

In the single frequency mode, above 10 kHz, it provides a sample rate of 1250 samples per second, as opposed to 330 for the MIZ-20A. The frequency range is the same, 50 Hz to 2 MHz. In the dual frequency mode, the second frequency is obtained by dividing the primary frequency by an integer from 2 to 10. The sample rate in this mode, above 10 kHz, is 400 samples per second. The primary frequency range during dual frequency operation is 1 kHz to 2 MHz.

Two types of signal mixing are available—a least squares data suppression mix (MIX-1) and a data enhancement mix (MIX-2).

In addition, the MIZ-22 is capable of supporting rotating probe sweeps up to 1500 r/min. C-scan, also known as waterfall, plots are also supported.

This section gives complete details about operating all the instrument's features.

4.1 Turning On Unit and Backlight

The illustration in 4-1 shows the location of the ON/OFF function keys. Complete the following steps in sequence to turn ON the MIZ-22 and the backlight.

- step 1** To turn the MIZ-22 on, hold the ON/OFF (reference figure 4-1) switch in for approximately one second, then release. The power turns on when the switch is released. At this time, the instrument goes through a brief self-test cycle, after which the setup menu is displayed on the screen. The self-test operates properly only if a probe is not attached to the *SINGLE* connector.

Figure 4-1. ON/OFF Control

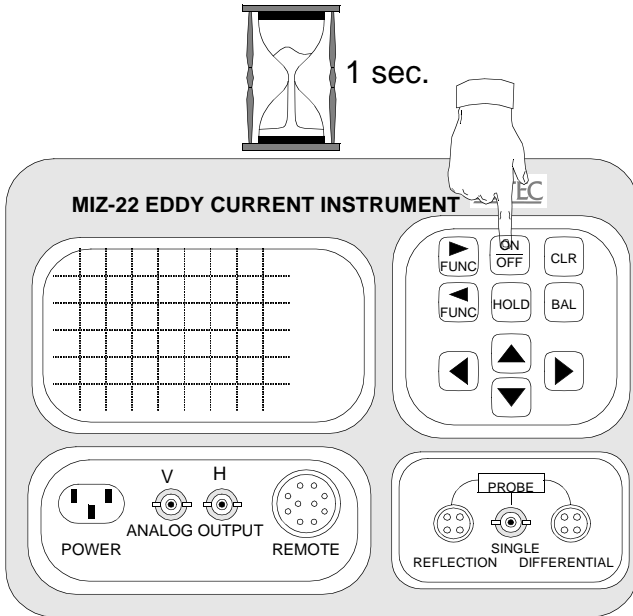

Hold the ON/OFF switch in for approximately 1 second.

If the self-test fails, press the *HOLD* button, and then cycle the power keeping the *HOLD* button depressed. This action shows the calibration loop on the display for diagnostic purposes.

- step 2** The ON/OFF button also controls the backlight. After the instrument is powered up, a brief tap on the button toggles the backlight on or off.



The unit consumes about 25% more power when the backlight is on, so for battery operation, it should be used only when required.

More information about battery life is listed in table 2-1 on page 2-18.

4.2 Instrument Setup

The illustration in figure 4-2 shows the location of the display menu. This menu displays the current setup parameters. You can move the highlight, or cursor, around in the menu by pushing the FUNC> or <FUNC buttons. When a menu line is highlighted, the function can be adjusted.

The following sections explain each parameter label and its function.

Figure 4-2. Display Menu

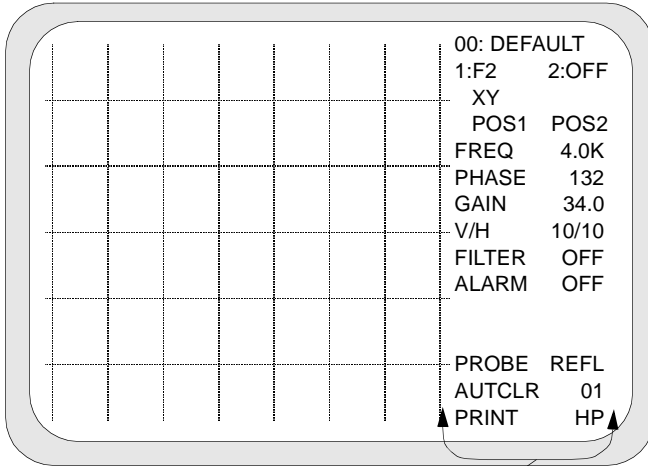

Display Menu

All of the current setup parameters are displayed.

4.2.1 Setup

The top line of the setup menu provides access to the 100 (0 to 99) possible test setups stored by the MIZ-22. The setups are stored in non-volatile memory, which are retained when the power is off or the battery pack is disconnected.

Each stored setup is comprised of essentially all the information present

in the setup menu. Also stored is the balance point calculated when *BAL* was last pressed. The information in memory is updated whenever the operator changes a setup parameter.

With the entire setup line highlighted, as shown in figure 4-3, use the *UP* or *DOWN* arrow button to toggle through the available setups (0 to 99). Press the *LEFT* arrow button to store the configuration. Any change to the Setup # automatically invokes the following on-screen message:

```
Last active configuration
is in temporary storage.
Changes will be lost
unless stored.
To store:
  1) Select config number.
  2) Press left arrow.
```

It is possible to store a new setup with a unique name or change the name of a recalled setup. Use the *LEFT* or *RIGHT* arrow button to highlight the individual character you want to change. Then use the *UP* or *DOWN* arrow buttons to toggle to the new character. The new character can be either a letter, number, or standard keyboard character.

Figure 4-3. Setup Control

On-screen "store" message

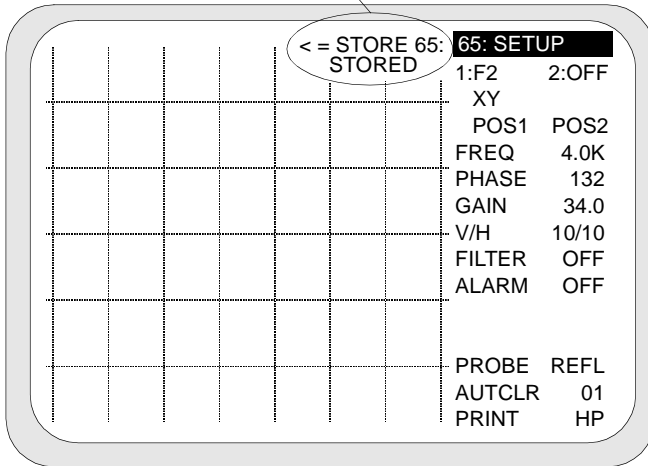

Use the UP or DOWN arrow keys to display the available setups.

4.2.2 Store-and-View Screen Image Buffer

The MIZ-22 contains a buffer feature that saves up to 10 screen images along with all the setup information. Once stored, images can be recalled for viewing or printing. Images are stored in non-volatile (retained when the power is off or the battery pack is disconnected) memory. This feature gives an operator the option of storing images at one location and then printing at a different location.

Figure 4-4. Screen Image Buffer Menu Selection

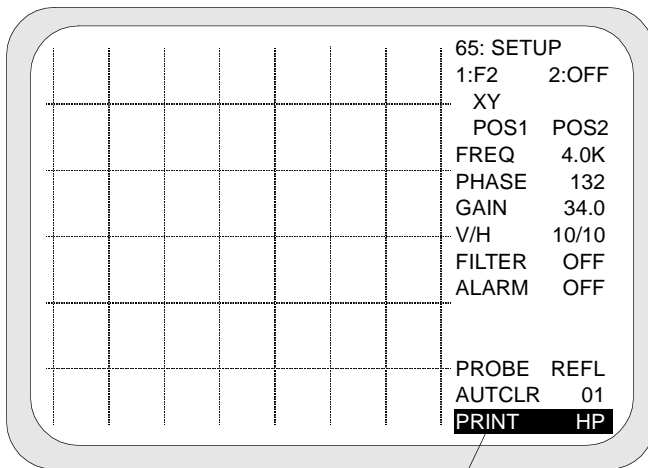

Menu location for store-and-view screen image buffer and print function

To store an image:

With the screen image drawn on the display, use either *FUNC* button until the *PRINT* (or second from bottom¹) menu line is highlighted. Use the *LEFT* or *RIGHT* arrow buttons to toggle the function between *STORE BUF 0* through *STORE BUF 9*, *VIEW BUF 0* through *VIEW BUF 9*, *PRINT EPS2*, *PRINT HP*, and *PRINT EPS1*. With any *STORE BUF #* highlighted, press the *UP* or *DOWN* arrow button to activate the function.

To confirm the image has been stored, the message, “STORED,” flashes on the display. All images remain in memory until you store a new image with the same number.

1. This menu line has more than one function and can display as *STORE BUF#* and *VIEW BUF#* also.

To view an image:

A stored screen can be recalled at any time. To do so, use either *FUNC* button until the *PRINT* (or second from bottom¹) menu line is highlighted. Press the *LEFT* or *RIGHT* arrow buttons to toggle the function between *STORE BUF 0* through *STORE BUF 9*, *VIEW BUF 0* through *VIEW BUF 9*, *PRINT EPS2*, *PRINT HP*, and *PRINT EPS1*. With any *VIEW BUF #* highlighted, as shown in figure 4-5, press the *UP* or *DOWN* arrow button to redraw the image on the display.

In the upper right-hand portion of the display grid, a reference number is displayed that identifies the recalled screen image.

1. This menu line has more than one function and can display as *STORE BUF#* and *VIEW BUF#* also.

Figure 4-5. View Buffer Mode

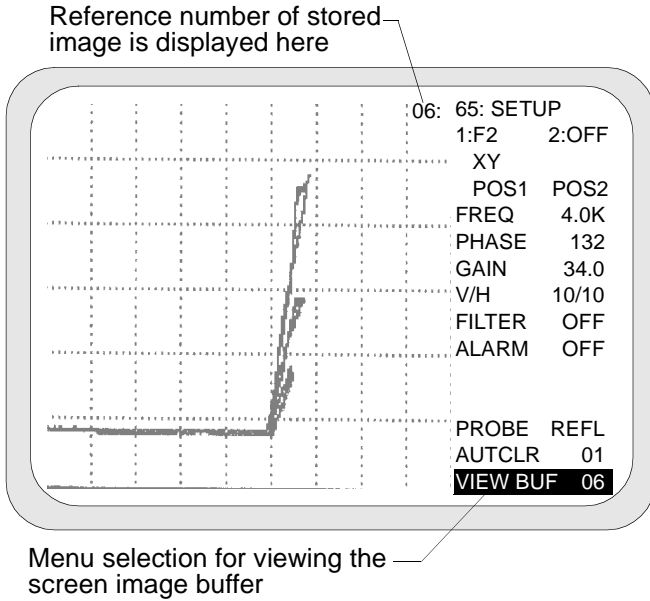

To print an image:

Whenever needed, stored images can be recalled and printed. The reference number prints with the screen image.

For more information about printing, see section 4.2.14 on page 4-39.

4.2.3 Display Parameters

The MIZ-22 is capable of displaying one or two channels.

With the first display selected (see figure 4-6) the *UP* and *DOWN* arrow buttons select three channel choices of F1 (primary frequency), F2 (second frequency) and MX (combination of F1 and F2).

Figure 4-6. Display Parameters

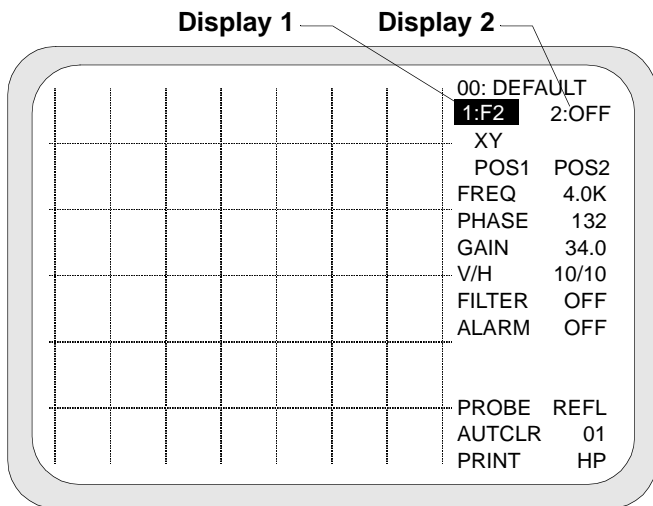

Use the UP and DOWN arrow keys to select three channel choices.

In single-frequency mode (2:OFF), all choices will actually display F1. The channel information shown in the

menu is for this displayed channel. In order to change the channel parameters, the channel must be displayed in Display 1. The channel will retain these parameters when selected in Display 2.

The MIZ-22 can be set to display data in either an XY impedance plane mode, a YT triggered sweep mode, or a cascaded scan. The *LEFT* and *RIGHT* arrow keys select the choice of the display type between XY, SWP (sweep), or SCAN (C-scan).

The MIZ-22 automatically synchronizes the sweep to a trigger at pin 5 on the REMOTE connector. In the absence of an external trigger or the trigger happening too fast, the unit will not sweep.

The second display has four channel choices—F1, F2, MX, and OFF. If the second display is enabled, the display type is only the XY-type.

Additionally, the position origin of either display is movable to anywhere on the display when POS 1 or POS 2 is highlighted. Use any of the arrow keys to move the position origin of the display on the screen.

4.2.4 Frequency

The frequency displayed in the menu is the frequency of the channel in Display 1. Reference the illustration in figure 4-7 for an example. The primary frequency range (F1) of the MIZ-22 is 50 Hz to 2 MHz. To change the frequency, move the cursor to the *FREQ* field. The *LEFT* and *RIGHT* direction arrows divide or multiply the frequency by factors of 10. The *UP* and *DOWN* direction arrows change the value in steps of 1% of the decade range.

The second frequency (F2) is adjustable from 1/2 to 1/10 of the primary frequency (F1). For example, if the prime frequency is 400 kHz, then F2 is adjustable from 200 kHz to 40 kHz. The dual frequency minimum for F1 is 1 kHz.

To adjust the second frequency, select F2 under Display 1. Move the cursor to the *FREQ* field. Use the *DOWN* arrow to turn F2 on and reduce the frequency. Use the *UP* arrow to increase the frequency and turn F2 off.

With MX selected under Display 1, you can change the frequency order of a mix channel to either F1-F2 or F2-F1. With the *FREQ* line highlighted, use any arrow key to flip the frequency order.

After the frequency is selected, press *BAL*, *CLR*, or move the cursor to cause data acquisition to begin.

Figure 4-7. Frequency Control

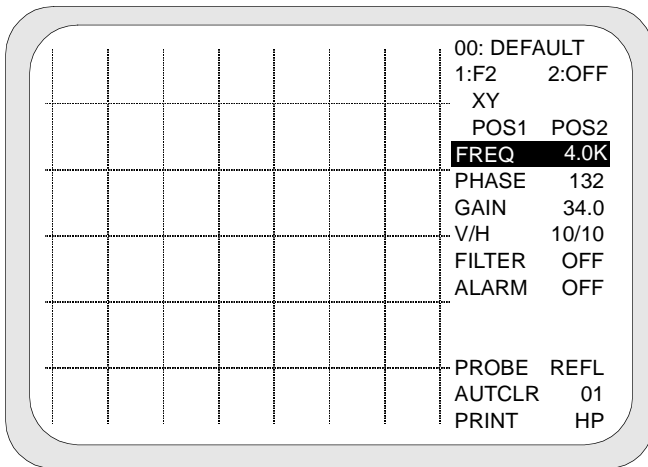

To change the frequency, move the cursor to the *FREQ* field.

4.2.5 Phase

The phase value of Display 1 is shown on the menu. Phase rotation is generally used to place a signal within a frame of reference that is familiar to the user. For instance, the lift-off signal from a probe is generally placed on the horizontal axis. See figure 4-8 for an example of the menu.

On the *PHASE* function line, a number between 0 to 359 appears on the right-hand side of the field. When the line is highlighted, the *UP* and *DOWN* direction arrows change the phase in units of one, and the *LEFT* and *RIGHT* direction arrows change the phase in units of ten. The rotation proceeds in a clockwise manner from 0° to 359°.

Figure 4-8. Phase Control

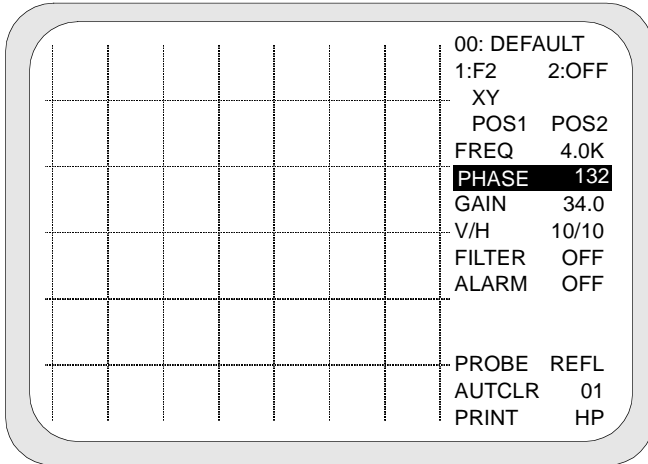

The phase value of Display 1 is shown on the menu.

4.2.6 Gain

The gain number of Display 1 is shown in the menu and can be varied from 0 to 49.5 dB in 1/2 dB steps. An example of the gain value is seen in figure 4-9. The *LEFT* and *RIGHT* direction arrows change the number by 6 steps, or 3 dB. The *UP* and *DOWN* direction arrows change the number in single steps. Both front end analog amplification and digital scaling to the display are affected by changes in the gain number, up to a value of 36. Above 36, the front end is at maximum gain, and all further increases affect the display scaling only.

The mix channel has a maximum gain of 27.5 dB.

Figure 4-9. Gain Control

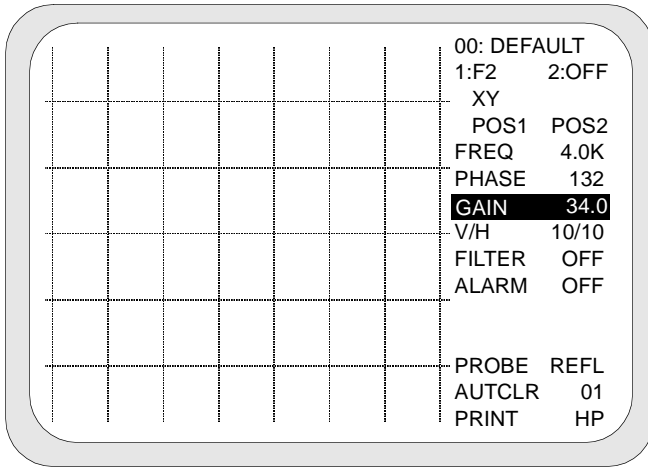

Each step represents 1/2 dB.

4.2.7 V/H Scaling

The vertical to horizontal deflection scale is varied from 01 to 50 using the direction arrow buttons (reference figure 4-10). This ratio controls the display scaling only, and does not affect the front end analog gain. The ratio is limited to a value less than 50 whenever the gain is set above 36.

You can adjust the vertical or horizontal scales independent of each other. The *UP* arrow button increases the vertical scale by one, the *DOWN* arrow button decreases the scale by one. The *RIGHT* arrow button increases the horizontal scale by one, the *LEFT* arrow button decreases the scale by one.

Figure 4-10. V/H Ratio Control

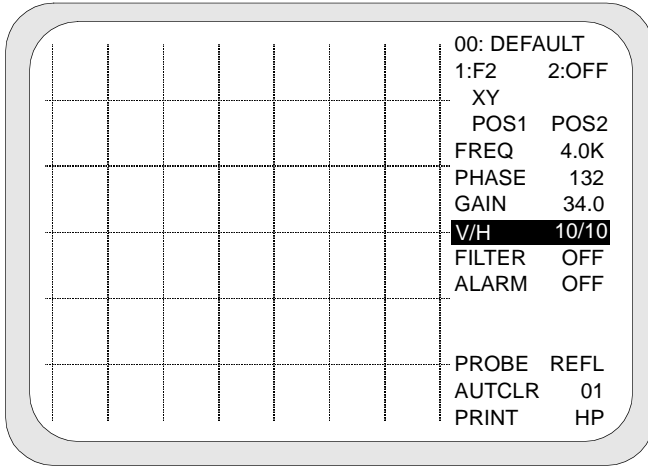

Use the UP and DOWN direction arrows to vary the V/H ratio.

4.2.8 Filters

Three selections are available for the filter—FILTER1, FILTER2, or FILTER OFF. Both are differential filters and provide either the first derivative or the second derivative of the signal. With the *LEFT* and *RIGHT* arrow keys, select the delta time increment. The filter corresponds with the channel. A filter is not provided for the MIX channel.

These filters can be used to suppress unwanted signals. To enable the function, set the cursor to the filter field, and use the UP or DOWN direction arrow to toggle between FILTER 1, FILTER 2, or FILTER OFF (reference figure 4-11). When the filter is on, a value from 01 to 15 appears in the field. This is the filter time constant. A value of 01 is the highest pass, 15 the lowest.

Figure 4-11. Filter Control

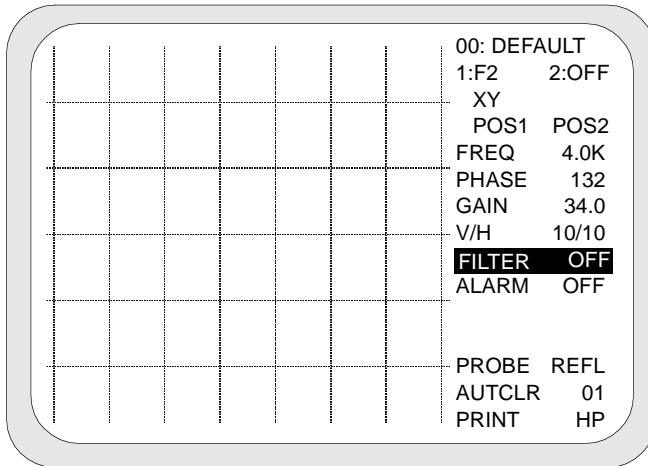

Use the UP or DOWN direction arrow to toggle between FILTER 1, FILTER 2, or FILTER OFF.

When *FILTER 1* is used with an absolute coil, rising edges show as positive signals, and falling edges as negative signals. In this case, *FILTER 2* should be used; because, it restores the original signal direction resulting in a more natural presentation of the flaw.

When the test coil is differential, *FILTER 1* generally gives the best presentation.

4.2.9 Alarm

The MIZ-22 alarm function provides audio and visual indications when the eddy current signal falls within a defined area (reference figure 4-12). The defined area is shown with a box on the screen. The alarm is selected for either Display 1 or Display 2, and can be either inside or outside the box.

You can change the center position of the alarm box when the *CHNG CENT* line is highlighted. With this function enabled, any arrow key moves the box's position in the corresponding direction.

Additionally, you can change the size of the alarm box when the *CHNG SIZE* line is highlighted. Use any of the arrow keys as shown in figure 4-12 to change the box's size in the corresponding direction.

The alarm indication is also present as a logic level on pin 3 of the remote connector, which may be used to control external equipment.

Figure 4-12. Alarm Control

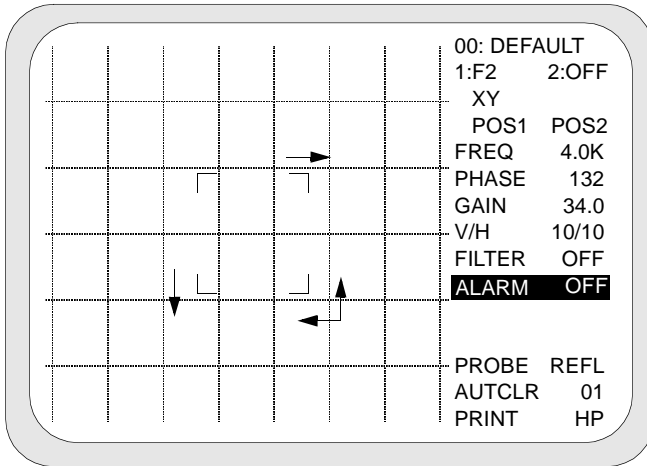

The arrows shown below indicate which and how each arrow key changes the size of the alarm box.

4.2.10 Data Buffer

The data buffer is only available during the *HOLD* mode. While in the *HOLD* mode, the instrument's memory retains the last six seconds of data in the single frequency mode and ten seconds in the dual frequency mode.

Once you are in the *HOLD* mode, pressing any button, except the *FUNC*>, <*FUNC*, and *ON/OFF* buttons, draws a horizontal strip chart of the data buffer.

The DATA# menu line shows the center of the display cursor location in the data buffer. This cursor is highlighted in figure 4-13. It is adjustable from start to end of the data buffer. The *RIGHT* and *LEFT* arrow keys are the coarse (fast) adjustment in units of ten. The *UP* and *DOWN* arrow keys are the fine (slow) adjustment in units of one.

Figure 4-13. Data Buffer

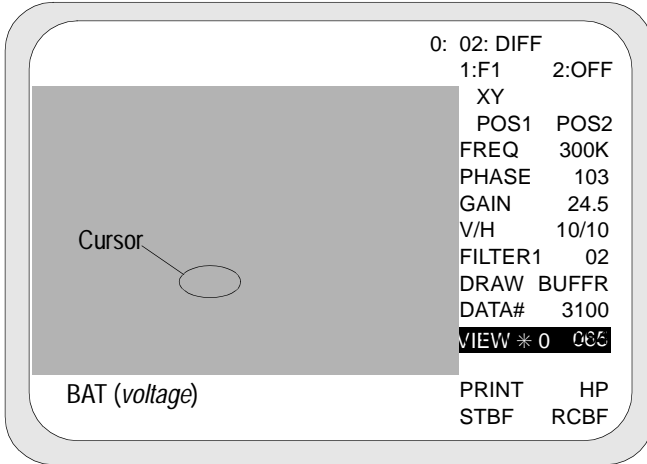

Adjust the width of the buffer display cursor.

The *VIEW*0* line shows the width of the buffer display cursor. In figure 4-13, the cursor width is 065. When the *VIEW* menu line is highlighted, the *RIGHT* and *LEFT* arrow keys adjust the cursor width in units of ten. In both the single and dual frequency modes, the cursor width is adjustable from 10 to 4990 data points. The *UP* and *DOWN* arrows expand and reduce the view of the strip chart area. Six settings are available:

- VIEW:*0=original size
- VIEW:*1=original size x 2
- VIEW:*2=original size x 4
- VIEW:*3=original size x 8
- VIEW:*4=original size x 16
- VIEW:*5=original size x 32

Figure 4-14 shows the same data buffer as figure 4-13 except with the *VIEW*5* expansion setting.

Figure 4-14. Expand/Reduce Strip Chart

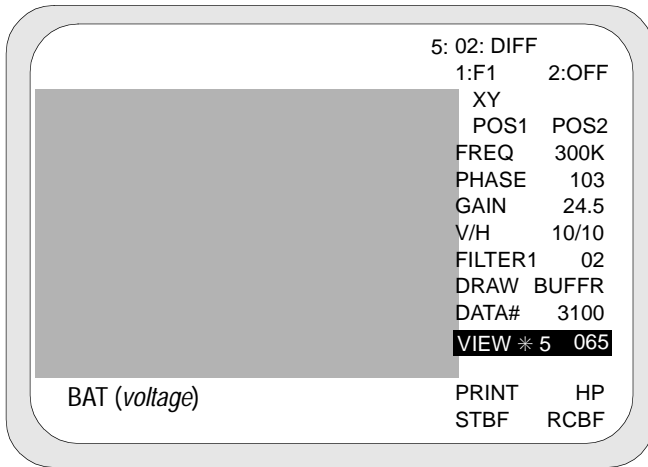

*The VIEW * line toggles the display between six different settings.*

The Expand/Reduce Strip Chart feature is especially useful for data acquired with Zetec's High-Speed Rotating Probe Gun. The user is able to expand the view large enough to separate individual pulses in small areas with many pulses.

While in the *HOLD* mode, you can also store (STBF) one screen image into the non-volatile reference

memory, which is retained when the power is switched off. This stored image can then be recalled (RCBF) for data comparisons. A useful application of this function is storing the reference signal from a standard, and then comparing this signal with the present test data.

Use the *FUNC* buttons to highlight either the *STBF* or *RCBF* function. With the function highlighted, pressing any of the arrow buttons activates the function.

4.2.11 Mix Menu

Press the *HOLD* button to view the MIX MENU line in the display menu as seen in figure 4-15. If the MIX MENU lines doesn't appear, verify that F2 is ON. With the *MIX MENU* line highlighted, press the *LEFT* or *RIGHT* arrow key to view the mix menu. Once the mix menu is displayed, use the <*FUNC* and *FUNC*> keys to highlight the different functions. Each function must be highlighted before it can be activated by pressing the up or down the arrow key.

Figure 4-15. Mix Menu

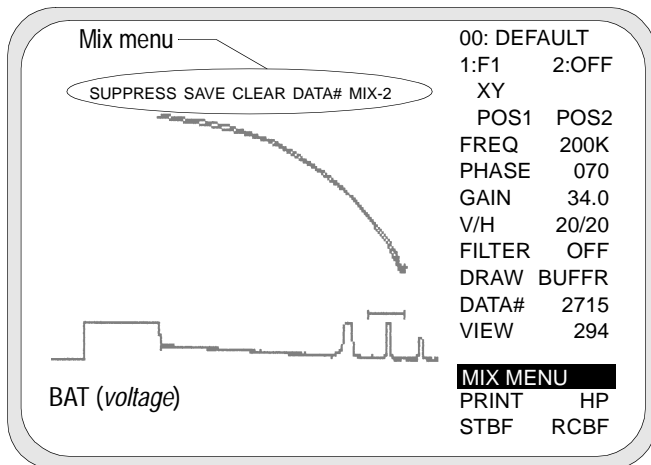

With the MIX MENU line highlighted, press an arrow key to view the mix menu.

The *SUPPRESS* function performs a least squares data suppression mix on the data displayed in the buffer display window.

The *SAVE* function is active only during *MIX2*. It performs a least squares data enhancement mix on the data displayed in the buffer display window.

The *CLEAR* function erases any mix coefficients that may have been created in the past. This function also needs to be activated prior to creating a new mix.

With the *DATA#* function in this menu highlighted, you can move the view window with the arrow keys to display the signal of interest without leaving the *MIX MENU*.

Two types of mixes are available with the *MIZ-22*—a least squares data suppression mix and a data enhancement mix. With the *MIX* function highlighted, the up and down arrow keys toggle between *MIX-1* and *MIX-2*. Use the *HOLD* button to exit the *MIX MENU* and return to normal operation of the *MIZ-22*.

4.2.11.1 MIX-1

This method provides only for the suppression of unwanted signals. When the *SUPPRESS* function is used, the data from the selected signal is used to provide a solution for the mix equation where the resulting output is as close to zero as possible. The coefficients are determined based on this one condition. The output of the MIX-1 channel displays a minimal size signal when the undesirable effect is scanned.

This same signal combination is used to display all signals. And so, the signal output from flaw indications is thus based on minimizing unwanted signals. Typically, if proper frequencies are chosen, the flaw response should be clearly distinguishable from other anomalies and resemble the signal from a flaw that is not affected by the undesirable effect. You can refer to the application examples in section 5.0 for further discussion about signal mixing.

4.2.11.2 MIX-2

In order to provide an alternative method to the user, MIX-2 is also available with the MIZ-22 instrument. This mix provides a method for both suppression of unwanted signals and enhancement of desired signals. When an undesirable signal is selected and the *SUPPRESS* function used, the mathematical solution is driven towards a zero output solution. When a desirable signal, such as a flaw of interest, is selected and the *SAVE* function used, the mathematical solution is driven towards providing a mix signal output that matches the flaw signal as seen in the primary frequency channel. Successive pressing of the *SUPPRESS* and *SAVE* functions are used to develop a mix solution that either better reduces the response from unwanted signals or better enhances the response from a desirable signal.

4.2.12 Probe Type

To change probe types, place the cursor on the PROBE field and use the direction arrows to select between the DIFF (differential), SING (single), or REFL (reflection) connectors. When not performing reflection-type work, it is generally preferable to use the differential input, which requires a balance coil, and thus has a higher sensitivity than the single output (reference figure 4-16).

Figure 4-16. Probe Type

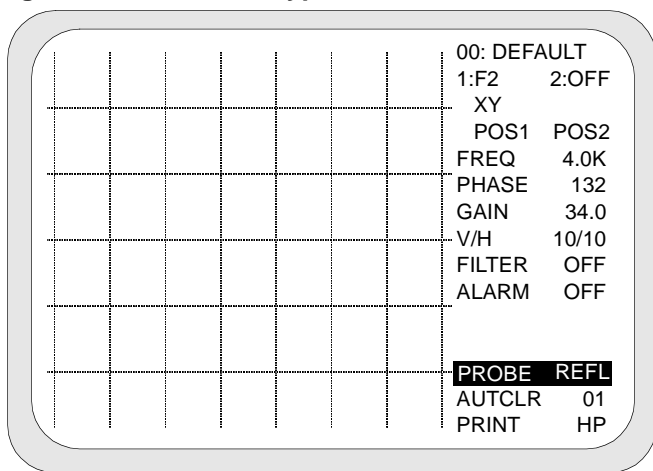

Use the direction arrows to select between DIFF (differential), SING (single), or REFL (reflection) connectors.

4.2.13 Auto Clear and Screen A/B

The MIZ-22 can be set to continually erase old data, or to store the signal on the screen. To choose between the modes, set the cursor on the *AUTCLR* field.

The MIZ-22 has the unique ability, in the *AUTOCLEAR* mode, to retain the newer data on the screen, while erasing older data. This is analogous to variable persistence on an analog storage scope. To set the mode to *AUTOCLEAR*, use the *UP* or *DOWN* direction button to toggle between *AUTCLR*, *SCREEN A*, and *SCREEN B* (reference figure 4-17).

In the *XY* display mode, the number on the right-hand side of the line is the approximate number of seconds, in tenths, that the data persists on the screen before it is erased. Use the *RIGHT* and *LEFT* direction arrows to increase or decrease the number between 2 and 50 (0.2-5.0 seconds).

However, while in either the *SWP* or *SCAN* mode this number represents other factors. For example, in the

SWP display mode, the number represents the number of sweeps.

But, while in the SCAN mode, the display will erase and restart after each complete C-scan plot is drawn on the display. Pressing the BAL button also restarts the C-scan plot.

The screen memory is volatile¹, therefore the test data will not be retained when power is switched off.

Figure 4-17. Auto Clear Control

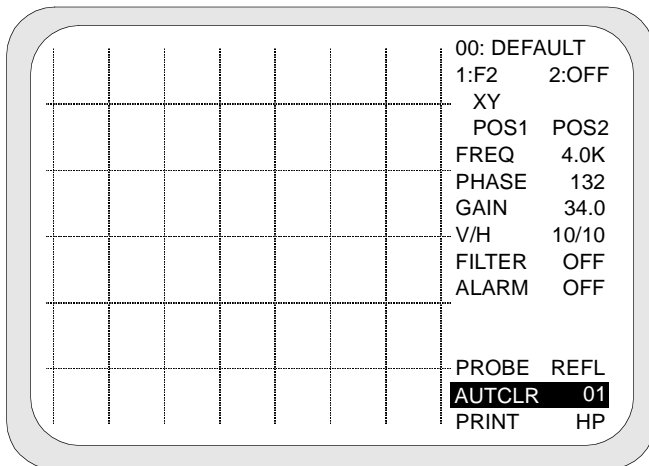

Set the mode to AUTOCLEAR, using the UP or DOWN direction arrow.

1. A characteristic of data that can be lost during power failure.

The MIZ-22 has two screen memories to which it can store and display data. To select the store-on screen mode, use the *UP* or *DOWN* direction arrows to toggle the display line between *SCREEN A*, *SCREEN B*, or *AUTCLR*. Once the display line indicates a screen, you can toggle between *SCREEN A* and *SCREEN B* with the *LEFT* and *RIGHT* arrow buttons as shown in figure 4-18.

The display line indicates the screen to which data is being written, and from which the signal is being displayed. Data will accumulate on the screen until the *CLR* button is pressed. The alternate screen can be selected at any time by using the *LEFT* or *RIGHT* direction arrow to toggle between the two. This lets you directly compare signals by using the following procedure:

- step 1** Write the first signal to one screen.
- step 2** Use the *LEFT* or *RIGHT* direction arrow to select the other screen.
- step 3** Write the second signal.

- step 4** Continuously hold down the *LEFT* or *RIGHT* arrow button. The screens will be alternately displayed at the keypad repetition rate.
-

Figure 4-18. Screen A/B

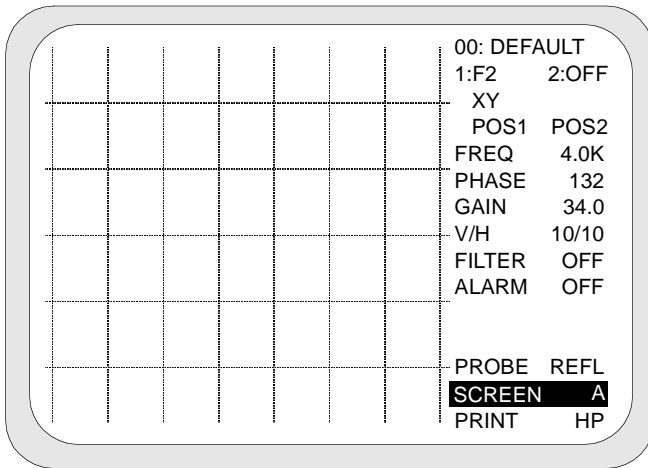

You can toggle between two screens to directly compare signals.

4.2.14 Printer Control

The MIZ-22 prints a graphic display of the test data and the accompanying setup to a HP 320, Epson, or Seiko DPU-411 Type II Thermal printer. The printers can be battery operated. Except for the Seiko printer, printers require the Zetec Micro Buffer, catalog number 2000-02-03.

To select the print function, move the cursor to the *PRINT* field. (If the print function mode is not shown, see page 4-8 for information about selecting the print mode for the MIZ-22.) With the *PRINT* field highlighted, you can use the *RIGHT* or *LEFT* arrow button to toggle the print selection between *STORE BUF*, *VIEW BUF*, *EPS2*, *HP*, *EPS1*—HP is the correct selection for ThinkJet printers, EPS1 is the correct selection for an Epson printer, and EPS2 is the correct selection the Seiko printer.

With the correct printer selection highlighted, activate the print by pressing either the *UP* or *DOWN* arrow button. The cursor disappears for several seconds and the system deactivates while the data is written to the print buffer.

4.3 Special Features

The MIZ-22 has two special features—digital conductivity measurement and non-conductive coating thickness measurement. Descriptions for each of these features are included in this section of the operating guide.

4.3.1 Digital Conductivity Measurement

All materials have a characteristic resistance to the flow of electricity. Those with the highest resistivity are classified as insulators, those having an intermediate resistivity are classified as semiconductors, and those having a low resistivity are classified as conductors. The conductors, which include most metals, are of greatest interest in eddy current inspection. The relative conductivity of the common metals and alloys varies over a wide range.

Capacity for conducting current can be measured in terms of either conductivity or resistivity. In eddy current inspection, frequent use is made of measurement based on the International Annealed Copper Standard (IACS). In this system, the conductivity of annealed, unalloyed copper is arbitrarily rated at 100%,

and the conductivities of other metals and alloys are expressed as a percentage of this standard.

In the metric system, these same ratings are based on units of Megasiemens/meter (MS/m). The conversion between conductivity in MS/m and IACS is shown in equation 4-1.

Equation 4-1. MS/m to IACS Conversion

$$\text{MS/m (1.7241)} = \% \text{ IACS}$$

Both the IACS and MS/m conductivity ratings of several common metals and alloys are given in table 4-1.

Table 4-1. Nominal Electrical Conductivity of Various Materials





% IACS	MS/m	Material
1.72	1	Inconel
2.5	1.5	304 Stainless Steel
3.5	2	Titanium
8 ¹	5	Pure Lead
9 ¹	5	Aluminum Silicon Bronze
16	9	Platinum, Palladium
22-30 ²	13-17	Beryllium Copper
27	16	Yellow Brass, 5056 Aluminum

Table 4-1. Nominal Electrical Conductivity of Various Materials (Cont.)

% IACS	MS/m	Material
28	16	Cartridge Brass
29 ¹	17	AL-2024-T4
30	17	Tungsten
32 ¹	19	AL-7075-T6
35	20	5052 Aluminum
42 ¹	24	AL-6061-T6
42	24	Commercial Bronze
47 ¹	27	AL-6061-T3
60 ¹	35	AL-1100-F
65	38	Pure Aluminum
75	44	Pure Gold
95-98 ³	55-57	Machining Copper
101 ¹	59	Oxygen-Free Copper
104	61	Pure Copper
106	62	Pure Silver

1. Material in stock at Zetec. Refer to the Zetec Probe Catalog for more information.
2. Depends on degree of precipitation hardening.
3. Depends upon oxygen content and other trace impurities.

With the MIZ-22, you can directly measure metals and alloys to display

conductivity as a numerical read-out in IACS. To switch to the instrument's conductivity measurement mode, use the  or  button to highlight the *SETUP* menu field. Use the  or  button to toggle through the available setups until the instrument displays “00: % IACS.”

An illustration of the Conductivity display is shown in figure 4-19.

Figure 4-19. Default % IACS Display

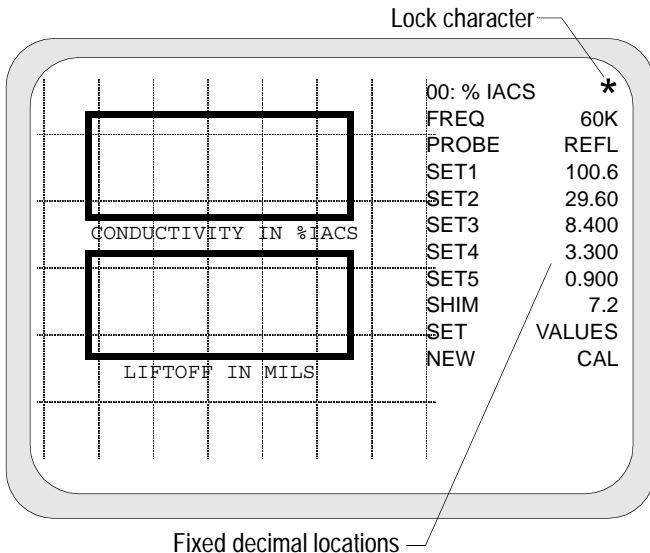

To change the frequency between 60, 120, and 240 kHz you must first disable the setup lock (*). Informa-

tion about the setup lock is located on page 4-7. With the lock disabled, highlight the *FREQ* line and use any arrow button to select between the three operating frequencies—60, 120, and 240 kHz.



*Deselecting the *FREQ* line automatically locks the new frequency, but you are still able to reset values and calibrate.*

The reflection probe shown in figure 4-20 is required for conductivity testing with the MIZ-22, and it is sold as a separate item. For more information about this probe, please contact the Zetec's customer service department.

Figure 4-20. T/D-*-SP Reflection Probe

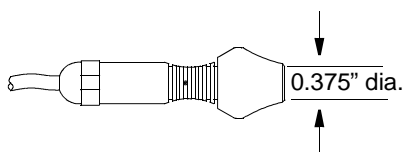

To determine the minimum thickness required for a test sample of various conductivity materials at different frequencies, refer to equations 4-2 and 4-3.

Equation 4-2. Calculation of Standard Depth of Penetration

$$\delta = \frac{26}{\sqrt{f\sigma}}$$

δ = standard depth of penetration in inches

f = frequency in Hertz

σ = conductivity in % IACS

Equation 4-3. Calculation for Minimum Thickness

2.6δ = minimum thickness required for test sample

δ = standard depth of penetration in inches

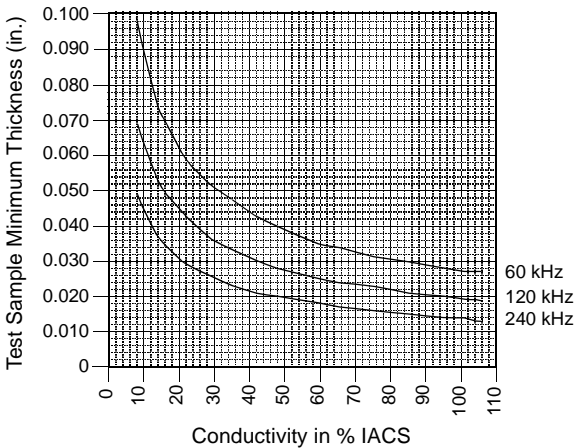

Keep in mind that each time you change the frequency or probe you will have to complete the calibration routine.

Before using the MIZ-22's conductivity measurement feature, the calibration curve values must be set and conductivity values verified with certified standards. The shim value for nonconductive coating measurements is set at the same time as any other Set Values. Once the calibration routine is complete, you can use the calibrated Set Values to zero the measurement range and compensate for drift.

The following list is an overview of the MIZ-22's conductivity measurement process:

- 1. Set Values (including Shim)*
- 2. Complete New Calibration (including Shim and Air values)*
- 3. Perform Conductivity and Nonconductive Coating Thickness Measurements*
- 4. Periodically Compensate for Drift during Measurement Worksession*



When setting up the instrument, as well as during a test, always keep the probe as perpendicular to the test piece as possible. Complete all the steps sequentially in both the *SET*

VALUES and *NEW CAL* sections before making any measurements.

SET VALUES. The five set points labeled *SET1* through *SET5* are the calibration points that are preset when the instrument is manufactured and represent a calibration curve. You can adjust these values to match those of your current calibration standards. However, it's recommended that the standards you use should be fairly close to the instrument's preset values.

As a minimum, three set points must be used to calibrate. The three coupon values must be as close as possible to the lower or upper three set points for the best results. Five set points are required for the most accurate results over the entire measurement range.

To change a set point:

- step 1** Use the  or  button to highlight the *SET VALUES* menu field as shown in figure 4-21. This action changes the read-out area to display the set point one at a time.

- step 2** Press the ◀ or ▶ button to toggle through the set points to the one you want to change. In this example, we are using *SET2*.
- step 3** Use the ▲ or ▼ button to change the value.
-

Figure 4-21. SET# Adjustment

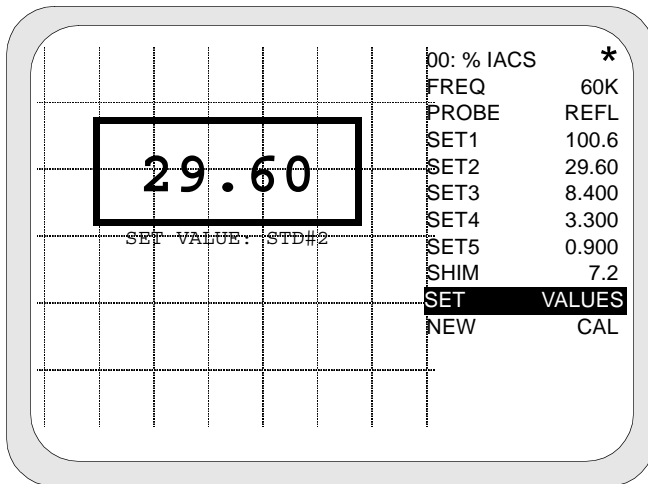

- step 4** Select a new set point. Notice the menu field for *SET2* updates with the new value.
- step 5** Repeat steps 2 and 3 for each set point you need to change.

The *SHIM* (spacer) is a known value that is used to represent a nonconductive coating such as paint thickness. Examples of items used as shims could be a single piece of paper, about three mils (0.003") thickness or Teflon tape of varying thickness.



To set the shim value:

- step 1** Highlight the *SET VALUES* menu field (see figure 4-22).

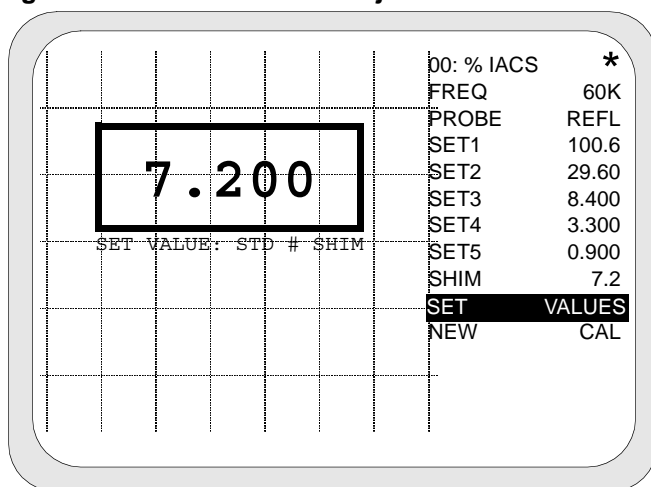
Figure 4-22. Shim Value Adjustment



- step 2** Use the ◀ or ▶ button to toggle through the selections until *STD # SHIM* highlights on the display.

- step 3** Use the  or  button to change the value.
- step 4** Toggle off the shim set point and you will notice the menu field for *SHIM* updates with the new value.

NEW CAL. After the Set Values have been selected according to the calibration standards, the MIZ-22 is ready for calibration using the probe and standards. It is important to remember that each time you change the frequency setting or replace the probe, you will have to recalibrate the instrument.

To perform the calibration sequence:





- step 1** Use the  or  button to highlight the *NEW CAL* menu field as shown in figure 4-23.

Figure 4-23. Calibration Mode

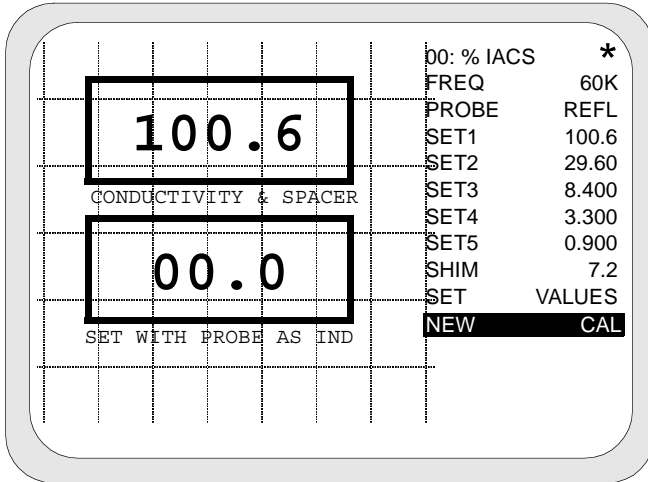

- step 2** Use the ◀ or ▶ button to toggle through the set values to display the value that matches the first calibration standard.
- step 3** Place the probe on the corresponding conductivity standard.
- step 4** Visually verify the value on the instrument and the standard is the same.

- step 5** With the probe remaining on the standard, press the  or  button to set the calibration point. An audible beep indicates the calibration is set.
- step 6** Repeat steps 2 through 5 for each calibration standard.

After calibrating with the standards, you must calibrate with each standard to include a shim value. These steps calibrate the instrument for nonconductive coating thickness measurements in conjunction with conductivity measurements. To calibrate the shim value:





- step 1** Use the  or  button to toggle through the set values until the value that matches the first calibration standard with “SHIM” displays as shown in figure 4-24.

Figure 4-24. Calibration with Shim



- step 2** Place the probe on the corresponding conductivity standard together with the shim.
- step 3** Visually verify the value on the instrument and the standard is the same.
- step 4** With the probe remaining on the standard, press the  or  button to set the calibration point. An audible beep indicates the calibration is set.

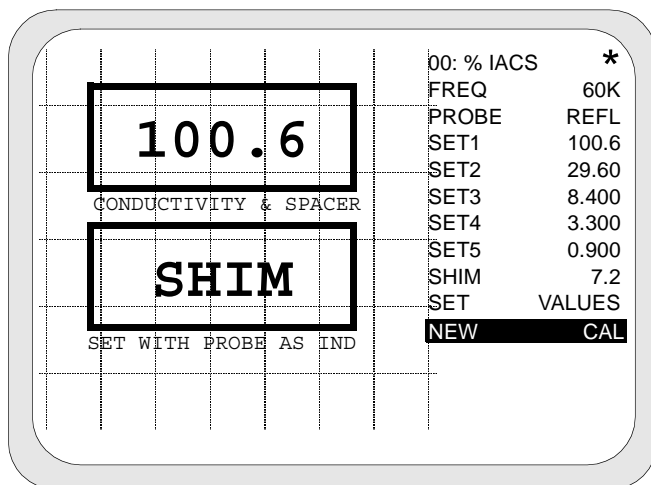



- step 5** Repeat steps 1 through 4 for each standard and shim.

After calibrating with the standards and shim, you can set the final calibration point as “probe in air” to zero. To set the “air” value:

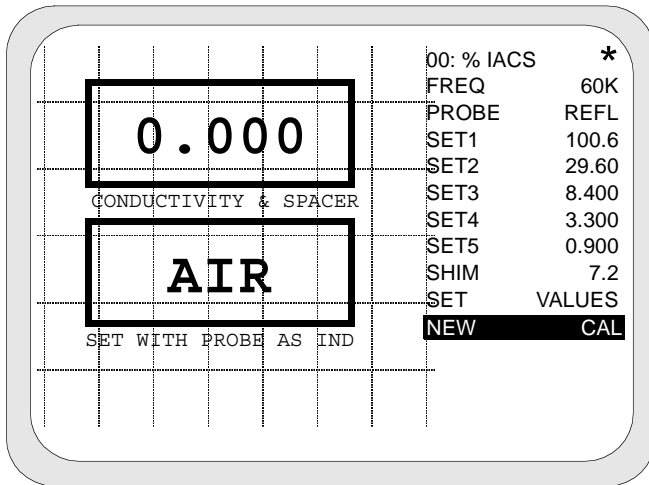
- step 1** Use the ◀ or ▶ button to toggle through the set values until the 0.000 value and “AIR” displays as shown in figure 4-25.

Figure 4-25. Probe in Air Calibration Point



- step 2** With the probe held in air, press the  or  button to set the calibration point. An audible beep indicates the calibration is set.
- step 3** Press the  or  button to deselect the *NEW CAL* function and exit the calibration mode.

Calibration is now complete, measure parts as required.

Drift Compensation. During a test session, the conductivity function should be checked for drift every 15 minutes. To compensate for any drift after calibration, complete the following steps:

- step 1** Place the probe on the test coupon or standard in the range where you are testing.
- step 2** Highlight the corresponding *SET#* as shown in figure 4-26.

Figure 4-26. Drift Compensation

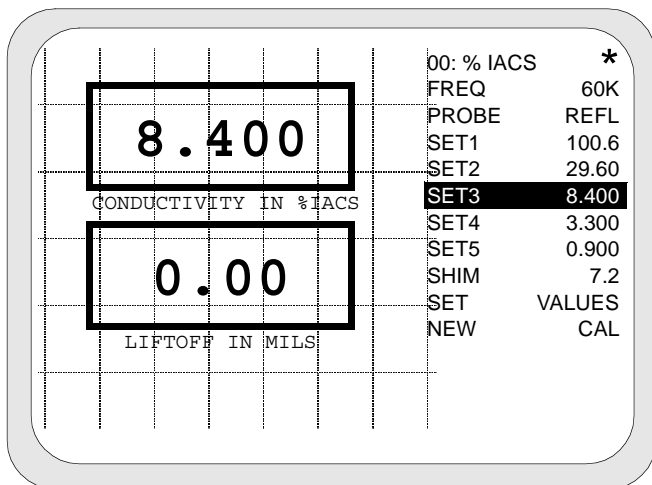

- step 3** Press any arrow button. The MIZ-22 zeros the calibration curve to the standard.

4.3.2 Nonconductive Coating Thickness Measurement

Requirements and setup for a nonconductive coating thickness test are the same as conductivity measurement. Follow the same process as the conductivity measurement section to setup the test.

During calibration, a known value is used to represent a nonconductive coating such as paint thickness. This known value should be somewhat close to the thickness that is expected during the test. Examples of items used as shims could be a single piece of paper, about three mils (0.003”) thickness or Teflon tape of varying thickness.

Higher thickness readings may be more accurate at a lower test frequency. The optimum frequency should be determined by experimenting with the test piece.

After the *SHIM* (spacer) value is calibrated, you can directly measure a coating thickness with the MIZ-22 at the same time as a conductivity measurement. The thickness value, in

thousands of an inch (mils), displays in the box below the conductivity value.

Figure 4-27. Nonconductive Coating Thickness Measurement Display

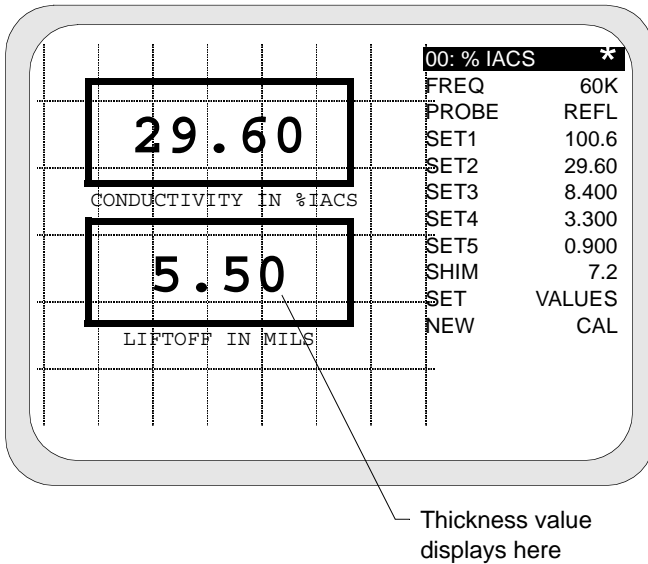

4.4 Auxiliary Features

The MIZ-22 has several auxiliary features. Descriptions for each of these features are included in this section of the operating guide.

4.4.1 Battery Voltage Readout

The battery voltage readout can be accessed at any time by placing the instrument in the *HOLD* mode. Also, the voltage appears automatically whenever it is below 9.6 volts. At this point there would be about 30 minutes of useful battery life remaining.

When the unit is plugged into the AC line, a voltage regulator supplies DC input power. In this case, the read-out indicates between 10.2 and 10.6 volts.

4.4.2 Automatic Turn-Off

The MIZ-22 turns itself off if the battery voltage drops to 9.0 volts, in order to prevent damage or deterioration of the cells. At this time, the unit should be placed on charge. The batteries should not be left in a discharged condition for a prolonged period of time.

4.4.3 Battery Pack

The MIZ-22 battery pack is comprised of nine Nickel Cadmium (Ni-Cad) D cells arranged in series and the required charging circuitry. The battery pack also includes a built-in AC receptacle, which allows a spare battery pack to be kept on charge while the MIZ-22 is in use.

A voltage select switch is located on the inner lid of the battery pack, to allow for 115 or 230 VAC operation.



Failure to set the switch properly may cause damage to the instrument.

The cells are charged at a nominal 400 mA when the unit is turned off and 100 mA when it is on. If the batteries are fully discharged, they will require 16 hours to recharge at the 400 mA rate. For optimum performance of the cells, it is best not to keep them on charge at the full 400 mA rate for an extended period of time, such as a week.

For optimum battery life, periodically discharge the batteries fully, by

leaving the instrument turned on until it automatically shuts itself off. Recharge the batteries immediately after this full discharge. Do not leave the batteries in a discharged condition.

Whenever possible, avoid charging the batteries at the full rate (unit turned off) when the ambient temperature is above 90°F (32.2°C). This helps to prolong cell life and maximize cell capacity.

Normal lifetime for the batteries, under which they will retain 90% charge, is 1,000 recharge cycles. However, in an emergency situation of total battery failure, they can be temporarily replaced with standard alkaline D cells.



Never plug the instrument into an AC line or use the instrument in an explosive atmosphere if the cells are replaced with any type but Ni-Cad.

4.4.4 Analog Outputs

The V and H analog outputs provide a voltage corresponding to the vertical and horizontal position of the data dot on Display 1. The V range is ± 2.5 volts, and the H range is ± 3.8 volts. Both outputs are at approximately zero volts when the data dot is in the center of the test area of the screen.

4.4.5 Computer Interface

The MIZ-22 has an RS-232C computer interface through the front panel *REMOTE* connector. Pin 1 is for ground, pin 10 for transmit (from the MIZ-22) and pin 8 for receive. No handshaking is required. The data format is 9600 baud, no parity, single stop bit.

The computer (or terminal) can exercise all the functions available on the MIZ-22 keypad, with the exception of power on or off. This allows full setups to be sent to the instrument, which stores in non-volatile memory, just as if they had been entered on the keypad.

In addition, the MIZ-22 can be commanded to trigger the Y-T sweep, to send the current setup to the computer, or to send one of the two types of eddy current data—raw data or screen data.

Raw data consists of 2-bytes each for the X and Y components (digitized data direct from the analog-to-digital converter, before it has been scaled or rotated for the screen). Screen data returns one byte, each corresponding to the present horizontal (0 to 192 pixels) and vertical (0 to 128 pixels) position of the data dot.

The commands listed in tables 4-2 and 4-3 are provided for external computer control.

The commands in table 4-2 are recognized in the power-up character command mode by the MIZ-22.

Table 4-2. Power-Up Commands

Command (ASCII)	ASCII Value	Response	Forth Command
I	73	131 bytes of information test	info.flag on new.funcs cr info.flag off
Q	81	triggers the sweep	serial.trigger
R	82	initialize	set
S	83	Sends 4 bytes of raw data (f1H, f1V).	@1R
T	84	Sends 8 bytes of raw data (f1H, f1V, f2H, f2V)	@2R
CTRL J	10	↓ direction arrow	6 user.key
CTRL K	11	↑ direction arrow	8 user.key
CTRL L	12	→ direction arrow	5 user.key
CTRL H	8	← direction arrow	7 user.key

Table 4-2. Power-Up Commands (Cont.)

Command (ASCII)	ASCII Value	Response	Forth Command
<	60	func-->	11 user.key
>	62	<--func	9 user.key
C	67	CLR	10 user.key
B	66	BAL	14 user.key
H	72	HOLD	12 user.key
F	70	Enable FORTH command line	exec.stop on
V	86	2 bytes display 1 screen data	@1d
W	87	4 bytes display 1&2 screen data	@2d
@	64	@ 200 bytes of setup	@su
!	33	! 200 bytes of setup	!su
M	77	@ 4420 bytes of screen	bmp
?	63	cursor location	function# @ emit

The MIZ-22 must be placed into the Forth command line mode, by typing F, before the following commands are recognized. Forth commands must be terminated with a CR (ASCII 13).

Table 4-3. FORTH Commands

Command	Response
FUNCS	Updates the screen status display.
BAL	Performs the balance function, same as the front panel key.
CLR	Clears the screen, same as the front panel key.
BMP	Sends 4420 bytes of screen bitmap display.
n @SU	Sends 200 bytes of configuration number n.
n !SU	Receives 200 bytes of configuration to number n.
n SET	Sets system configuration to number n. Use FUNCS to update display.
@1D	Sends 2 bytes of screen data (d1H, d1V).
@2D	Sends 4 bytes of screen data (d1H, d1V, d2H, d2V).
@1R	Sends 4 bytes of raw data (f1H, f1V).
@2R	Sends 8 bytes of raw data (f1H, f1V, f2H, f2V)

Table 4-3. FORTH Commands (Cont.)

Command	Response
n BAUD	Sets baud rate on serial port to n. Default is 9600.
DOIT	Enters character command mode from FORTH.

4.4.6 Probe Gun Interface

The MIZ-22 probe gun interface is provided by the *REMOTE* and the probe connectors. The *REMOTE* connector is designed to interface with Zetec's Motorized Rotating Bolthole Scan Gun and High-Speed Bolthole Scan Gun. Contact Zetec for more information about both of these items. Other rotators may also be used.

The *REMOTE* connector provides nominal 10 VDC power for the probe gun motor on pin-2, ground on pin-1, and a trigger input on pin-5. The trigger input is meant to be a ground closure, which occurs once every rotation of the probe. The MIZ-22 automatically calculates the sweep speed of the display according to the time between the triggers. The maximum trigger repetition rate is 10 per second. There is no minimum rate; although, if no trigger is present with *SWEEP* on, the instrument does not sweep. The *REMOTE* connector also provides balance (pin-7) and hold (pin-9) inputs, so the operator may control these functions from push-buttons on the probe gun. These

are ground closures, which are electrically paralleled with the front panel keys.

The Zetec probe gun is designed to provide the signals for a two-coil system—either a differential or reflection type. The cable included with the Zetec probe gun provides a splitter to divide the signals from the gun between *REMOTE* and the appropriate probe connector.

When interfacing to the *REMOTE* connector with an accessory not manufactured by Zetec, care should be taken not to short the DC power output (pin 2) to ground (pin 1). When operating from battery power, a short at this point blows the fuse F4 in the battery pack.

Since the MIZ-22 has a high sampling rate of 1250 samples per second, it also supports the Zetec High-Speed Scanner that rotates at up to 1500 revolutions per minute.

4.4.7 Self-Test

The MIZ-22 self-test executes automatically whenever unit power is turned on.



The self-test executes properly only if a probe is not attached to the SINGLE (BNC) connector.

The self-test checks the detection circuitry for proper operation of the probe signal. During self-test, a probe signal is simulated internally. The signal is demodulated and checked for amplitude and phase accuracy. If the unit passes the test, a right triangle is drawn on the screen, after which the screen is cleared and normal operation proceeds.

If the test fails, the results are briefly displayed on the screen. If you want to show the calibration loop on the display for diagnostic purposes, press the *HOLD* button, and then cycle the power while keeping the *HOLD* button depressed.

At this point, operation will not proceed unless the power is cycled on the MIZ-22.

While the MIZ-22 is in the self-test mode, all other functions are disabled with the exception of the *UP* and *DOWN* arrow keys. These keys toggle through the following seven test frequencies and restart the internal cycling.

- 100 Hz
- 1.0 kHz
- 10 kHz
- 100 kHz
- 400 kHz
- 1.0 MHz
- 2.0 MHz

Two sets of test results are shown on the left side of the screen. The upper set is the X and Y amplitude error. During the test, the instrument generates two signals of a known amplitude, which are 90° apart in phase. The X and Y amplitudes are required to measure 80 (± 8 counts) from the A/D converter. The phase between the two signals is required to be measured as $90^\circ \pm 3^\circ$.

The second set of results is for a quadrature phase error check. Reference the display shown in figure 4-28 for a sample of the self-test screen.

Figure 4-28. Self-Test Display Example

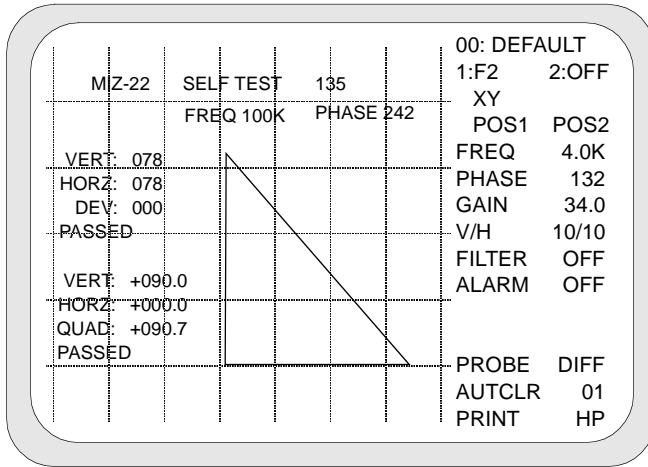

A wide deviation in expected results indicates some sort of catastrophic failure. A failure of only a few percent may be acceptable; however, this demonstrates the need for routine calibration.

The next section of this manual has examples of several applications for the MIZ-22.



5.0 Application Examples

Since there are so many attributes of an object that can be examined by eddy current testing, each particular situation requires its own unique test setup. There are, however, several fundamental variables that need to be considered in order to optimize results. Following is a summary of some of these considerations. The relative importance of each depends upon the specific test.

5.1 Test Design Considerations

The type of probe has a significant bearing on the outcome of a test. The shape of the probe is important, since it needs to have close contact with the test piece for good sensitivity. Small changes in the coupling of the source magnetic field to the test object can cause variations in results which will overwhelm the desired test data.

In addition to the shape of the probe, several coil configurations are available. The coils in

an eddy current system must generate the source magnetic field as well as detect the secondary magnetic field from the test piece. The same coil can do both jobs, and the simplest version of this is the single, or absolute coil. The instrument detects changes across this coil with no other reference to zero, from the large initial offset generated by the coil itself. Hence, the gain of such a system is somewhat limited.

An improved situation is to include a second coil to electrically balance out the first. This is called a differential probe. The second coil is sometimes contained within the probe connector or even in the instrument itself. The best sensitivity for a differential configuration is achieved, however, when the second coil is mounted in such a way as to see a similar material as does the test object. In this way, maximum balance and highest gain can be achieved.

A variation on both single and differential probes is the reflection, or driver-pickup configuration. In this case, the source coil is separated from the sensing coil. This is particularly useful in low frequency work, where the source coil tends to heat up and change shape. Since drive current does not flow through the sensing coil, it does not undergo these geometry changes, which

would otherwise introduce drift into the signal.

Eddy current coils are optimized for certain frequency ranges, and the frequency chosen depends on the desired depth of penetration into the test object.

Depending upon probe sensitivity and instrument gain, an operating frequency of 100-Hz might penetrate a half-inch of aluminum; however, smaller flaws may be missed at this frequency. A signal of 1-MHz provides excellent response to surface variations; however, this frequency may generate unwanted noise due to variations in contact of the probe to the material. Some degree of experimentation is generally required to optimize the frequency for a particular test.

The test procedure itself can be as important as choosing the probe and operating frequency. Every instrument has a certain frequency response, which means that the signal of interest must be present for a certain minimum period of time before it will generate a response. This is an important consideration in automated testing, where the material of interest may be moved past the probe very quickly.

Another procedural consideration is temperature. Both probes and test materials are subject to changes from temperature. If a

portable instrument is moved between temperature extremes, some stabilization time should be allowed for the probe before tests are performed. Similarly, for a test such as conductivity, an instrument should be calibrated on a standard which is close to the same temperature as the object under test.

Examples of common eddy current tests performed on the MIZ-22 are included here as general guidelines. Many creative variations are possible.

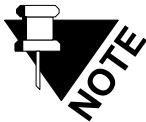

Specific gain and phase values are probe, instrument, and material dependent. The exact settings for a similar result will vary according to the situation.

5.2 Surface Crack Example

The depth of surface cracks can be estimated by comparing the phase and amplitude of the generated eddy current signal with a test standard.

The requirements for this test are listed in table 5-1.

Table 5-1. Requirements for Surface Crack Test

Description	Part No.	Catalog No.
		
Probe-Detachable Tip Spring-Loaded Surface Scan Probe Frequency Range 50-500 kHz.	DT-100-125	910-4802

Table 5-1. Requirements for Surface Crack Test (Cont.)

Description	Part No.	Catalog No.
 <p>The diagram shows a rectangular aluminum plate with several circular standards and electrical connection points. The standards are labeled with their IACS values: 100.7% IACS, 29% IACS, 4.8% IACS, and 8.3% IACS. Electrical connections are labeled A through P. Dimensions for some connections are given: 1/2 Ø, 3/8 Ø, 5/16 Ø, and 1/4 Ø. A '3' is also indicated near connection D.</p>		
Multi-Purpose Plate Standard Material-Aluminum	N/A	950-5700
Connections	Connect the probe to the instrument "DIFFERENTIAL" connector.	

Complete the following steps in sequence to setup and perform a surface crack test.

Setup

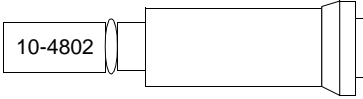
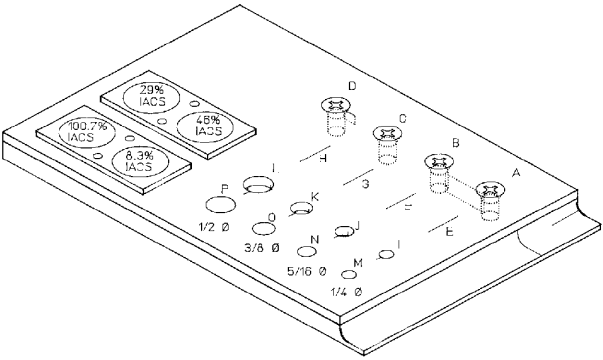
- step 1 Set the instrument variables as illustrated in figure 5-1.
- step 2 Place the probe on a defect free area of the standard.
- step 3 *NULL* the instrument.

- step 4 Scan the probe across NOTCHES “E”, “F”, “G”, and “H”, consecutively.

Figure 5-1. Surface Crack Indication

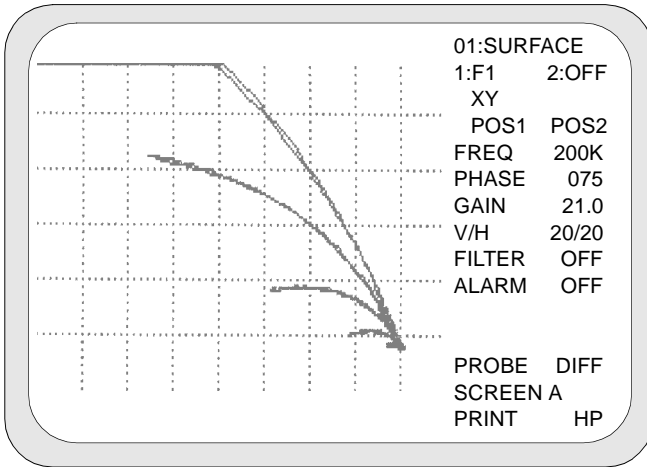

The V/H scale is adjustable to enhance the signal to lift-off separation.

5.3 Aircraft Skin Corrosion Example

Corrosion of hidden surfaces can be detected using eddy current. It is a comparative technique in that readings made in a suspect area are compared with instrument readings obtained from sound, non-corroded material.

The requirements for this test are listed in table 5-2.

Table 5-2. Requirements for Aircraft Skin Corrosion Test

Description	Part No.	Catalog No.
		
Detachable Tip Driver-Pickup Spot Probe Frequency Range 500 Hz- 30 kHz	DTDP-500-SP	910-4880

Table 5-2. Requirements for Aircraft Skin Corrosion Test (Cont.)

Description	Part No.	Catalog No.
 <p>The diagram shows a rectangular area representing aircraft skin. At the top, there are two rows of probe positions. The first row has positions E, F, G, A, and B. The second row has positions H, I, J, C, and D. Below these are three circular probe positions labeled K (.004), L (.008), and M (.012). To the right of positions E, F, G, H, I, J, C, and D are two sets of specifications: '5/32 CSK 100°' and '3/16 CSK 100°'. There are also four crosshair symbols (⊕) located at the corners and midpoints of the diagram's bounding box.</p>		
Aircraft Skin Standard Material-Aluminum	N/A	950-5600
Connections	Connect the probe to the instrument "REFLECTION" connector.	

Complete the following steps in sequence to setup and perform a corrosion test.

Setup

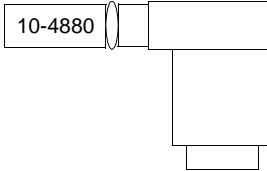
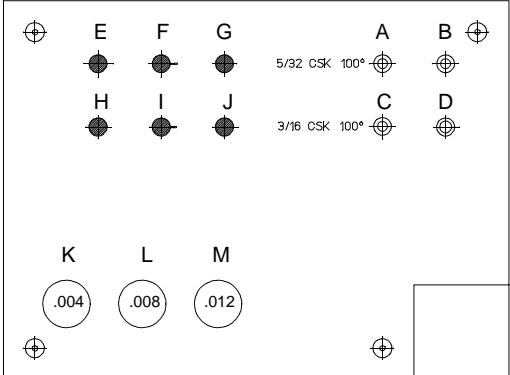
- step 1 Set the instrument variables as illustrated in figure 5-2.
- step 2 Place the probe on a defect free area of the standard.
- step 3 Press the balance button on the instrument.

step 4 Scan the probe across flaws K, L, and M, consecutively.

Figure 5-2. Corrosion Indication

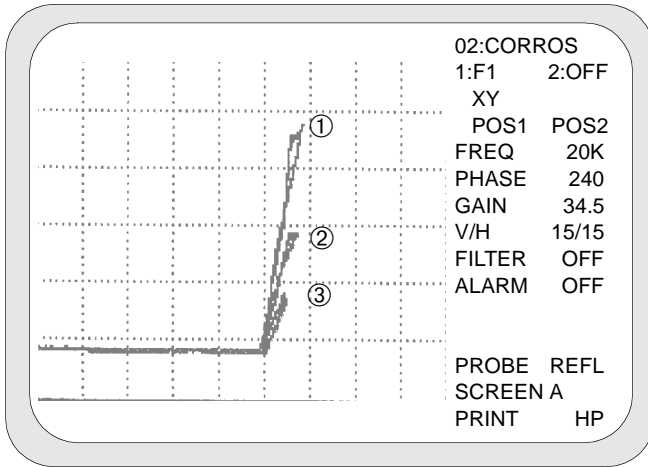

① 0.012"

② 0.008"

③ 0.004"

5.4 Alloy Sorting Example

The ability of eddy current to detect changes in conductivity makes it ideal for sorting materials. Using the same principles, eddy current can also be used to detect heat-damaged material.

The requirements for this sorting test are listed in table 5-3.

Table 5-3. Requirements for Alloy Sorting Example

Description	Part No.	Catalog No.
		
Probe-Detachable Tip Spring-Loaded Surface Scan Probe Frequency Range 50-500 kHz.	DT-100-125	910-4802

Table 5-3. Requirements for Alloy Sorting Example (Cont.)

Description	Part No.	Catalog No.
 <p>The diagram shows a rectangular aluminum plate with four circular alloy standards. The standards are labeled with their respective IACS values: 29% IACS, 100.7% IACS, 8.3% IACS, and 48% IACS. Surrounding the standards are various probe connections labeled A through M. Dimensions for these connections are provided: A (1/2 Ø), B (3/8 Ø), C (5/16 Ø), D (1/4 Ø), E (1/2 Ø), F (3/8 Ø), G (5/16 Ø), H (1/4 Ø), I (1/2 Ø), J (3/8 Ø), K (5/16 Ø), L (1/4 Ø), and M (1/2 Ø).</p>		
Multi-Purpose Plate Standard Material-Aluminum	N/A	950-5700
Connections	Connect the probe to the instrument "DIFFERENTIAL" connector.	

Complete the following steps in sequence to setup and perform a conductivity test.

Setup

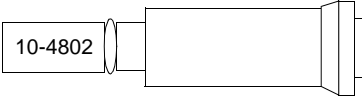
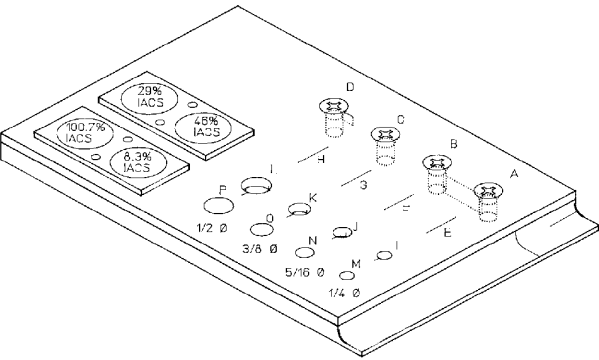
- step 1 Set the instrument variables as illustrated in figure 5-3.
- step 2 Hold the probe away from any conductive materials.
- step 3 Balance the probe.

step 4 Center the probe on each of the conductivity calibration blocks.

Figure 5-3. Alloy Sorting Example

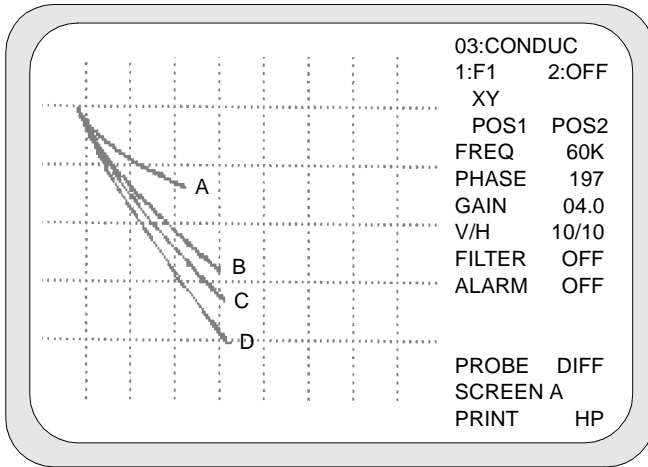

- A—Lead 8.3% IACS
- B—Aluminum 29% IACS
- C—Aluminum 46% IACS
- D—Copper 100.7% IACS

5.5 Fastener Hole Example

Special probe shapes and sizes are designed with specific test parameters in mind. In this example, the probe's outside diameter is slightly smaller than the fastener hole it is intended to inspect.

The requirements for testing a fastener hole are listed in table 5-4.

Table 5-4. Requirements for Fastener Hole Example

Description	Part No.	Catalog No.
	Z2-125-SC-* ¹	920-8220
		

Table 5-4. Requirements for Fastener Hole Example (Cont.)

Description	Part No.	Catalog No.
Multi-Purpose Plate Standard Material-Aluminum	N/A	950-5700
Connections	Connect the probe to the instrument "DIFFERENTIAL" connector.	

1. *=OD of probe.

Complete the following steps in sequence to setup and perform a fastener hole test.

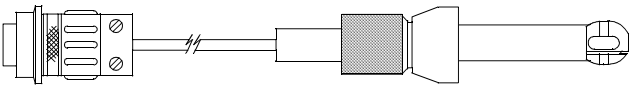
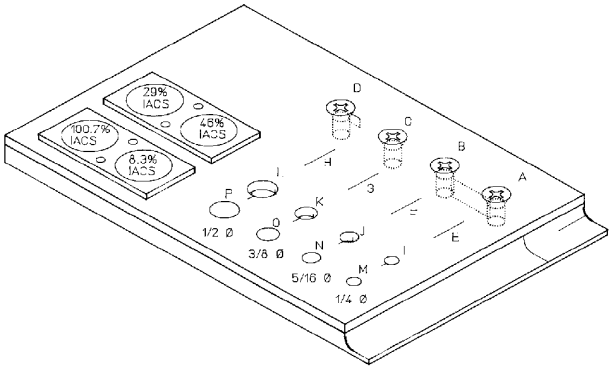
Setup

- step 1 Adjust the distance between the coil and the probe handle to approximately 0.5" (13mm).
- step 2 Set the instrument variables as illustrated in figure 5-4.
- step 3 Insert the probe into "HOLE N" (hole without a flaw), and balance the MIZ-22.
- step 4 Insert the probe into "HOLE J".
- step 5 Rotate the probe 360°.

Figure 5-4. Fastener Hole Flaw Indication

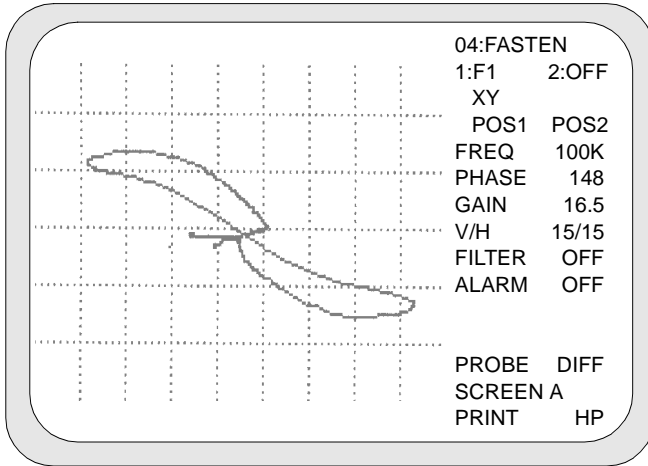

The V/H scale is adjustable to enhance the signal to lift-off separation.

5.6 Countersink Example

The special shape of the countersink probe is designed to match the size and angle of a countersink hole. In this example, the differential coil is located at an angle that keeps the surface-to-coil spacing a constant.

The requirements for a countersink inspection are listed in table 5-5.

Table 5-5. Requirements for Countersink Test Example

Description	Part No.	Catalog No.
		
Differential Countersink Probe Freq. Range 50-400 kHz.	A/MBH*-CSSC	920-8330
Adapter Cable (Zetec 4-pin to Microtech 4-pin)	N/A	940-1721

Table 5-5. Requirements for Countersink Test Example (Cont.)

Description	Part No.	Catalog No.
Aircraft Skin Standard Material-Aluminum	N/A	950-5600
Connections	Connect the probe to the instrument "DIFFERENTIAL" connector.	

Complete the following steps in sequence to setup and perform a countersink hole test.

Setup

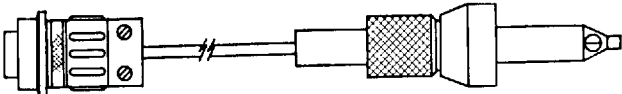
- step 1 Set the instrument variables as illustrated in figure 5-5.
- step 2 Insert the probe in hole "B" (hole without a flaw).
- step 3 Balance the probe.

step 4 Insert the probe in hole “A.”

step 5 Rotate the probe 360 °.

Figure 5-5. Countersink Flaw Indication

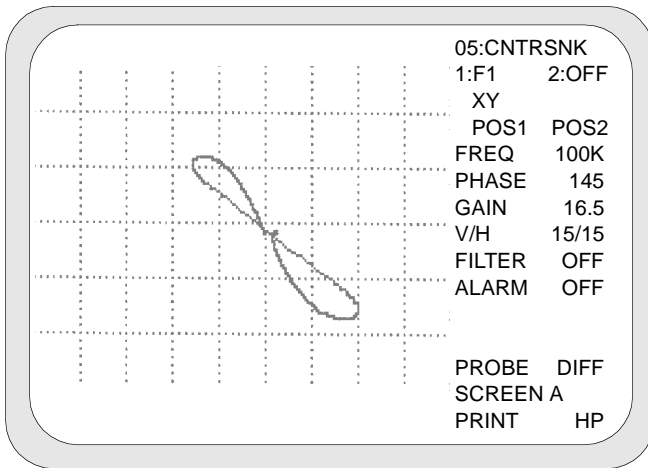

The V/H scale is adjustable to enhance the signal to lift-off separation.

5.7 Triggered Sweep with Filter Example

Filters can be used to suppress unwanted signals such as low frequency rotational noise due to angle of probe or incorrect size. This example uses both filters with two types of test coils—differential and absolute.

The requirements for this example are listed in table 5-7.

Table 5-6. Requirements for Triggered Sweep with Filter

Description	Part No.	Catalog No.
		
Rotating Probe Gun	N/A	2000-02-05
Rotating Bolthole Probe Absolute coil Frequency Range 50-400 kHz	MBH/S-**	921-8400
Rotating Bolthole Probe Differential coil Frequency Range 50-400 kHz	A/MBH-SC-**	921-8420

Table 5-6. Requirements for Triggered Sweep with Filter (Cont.)

Description	Part No.	Catalog No.
 <p>The diagram shows a rectangular aluminum plate with several circular standards. Three standards are labeled with their IACS values: 100.7% IACS, 20% IACS, and 4.6% IACS. Another standard is labeled 0.3% IACS. There are also several connection points labeled with letters A through P. Dimensions for some points are given: 1/2 Ø, 3/8 Ø, 5/16 Ø, and 1/4 Ø. The plate is shown in a perspective view.</p>		
Multi-Purpose Plate Standard Material-Aluminum	N/A	950-5700
Connections	<ul style="list-style-type: none"> -Connect the probe to the probe gun -REMOTE connector from probe gun to REMOTE on instrument -Amphenol 4-pin from probe gun to DIFFERENTIAL instrument connector. 	

Complete the following steps in sequence to setup and perform a triggered sweep with filter test.

Setup

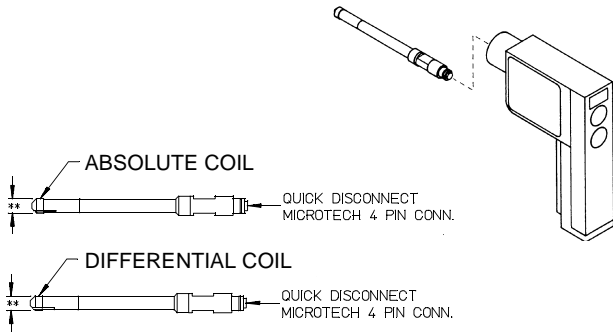
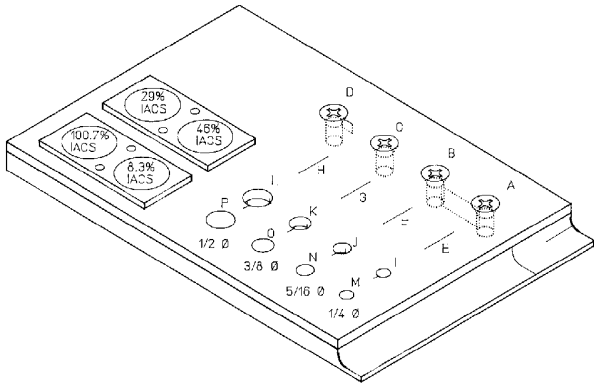
- step 1 Set the instrument variables as shown in figure 5-6.

- step 2 Select a test frequency that allows good flaw detection with low surface noise (50-200 kHz).
- step 3 Set a medium gain (10-20).
- step 4 Set *AUTCLR* on; set the *SWEEP* off.
- step 5 Insert the probe into a standard. With motor off, balance on a defect-free area of the standard. Keep the probe as perpendicular as possible, and set the speed to high.

Figure 5-6. Absolute Coil Signal without Filter

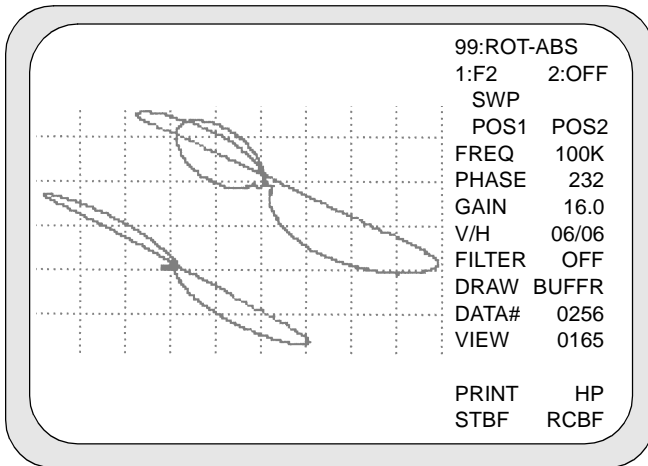

- step 6 Use manual rotation to set the lift-off noise, if present, to horizontal. This is particularly important for tests using the triggered sweep, because it is the vertical signal that is displayed, and it is desirable to keep it low in noise.
- step 7 Set *SWEEP* to on. After a few moments, the sweep will automatically stabilize. Use *FILTER 1* for the differential coil probe, and *FILTER 2* for an absolute coil probe. Use of the filter will keep the probe balanced when it makes the transition from air to metal, and will remove low frequency noise.
- step 8 When selecting a filter value decrease the number (raise the high pass) until noise is suppressed, while adequately maintaining good amplitude of the flaw signal.
- The signal shown in figure 5-6 represents an absolute coil signal without any filtering. You will notice the low frequency rotational noise, due to angle of probe or fill factor.

Figure 5-7 shows an absolute coil signal with *FILTER 1*. The rotational noise is mostly removed, but the rising and falling slopes show as positive and negative excursions.

Figure 5-7. Absolute Coil Signal with FILTER 1

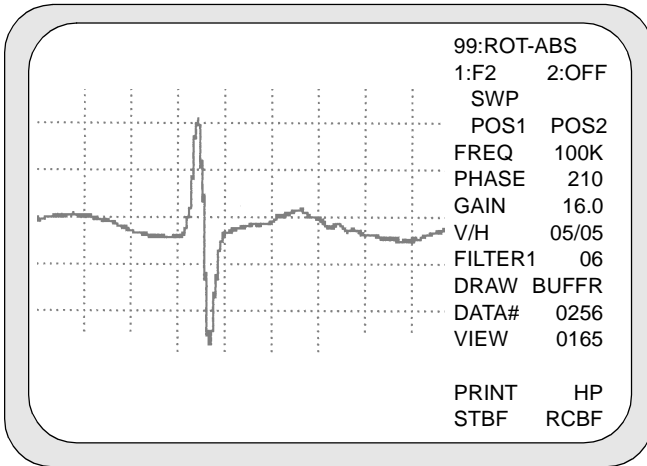

An absolute coil signal with *FILTER 2* is shown in figure 5-8. The rotational noise is entirely removed, and the negative excursion is mostly eliminated. This filter results in a flaw presentation more like the original (figure 5-6). The small negative lobes are a residual of the filter process.

Figure 5-8. Absolute Coil Signal with FILTER 2

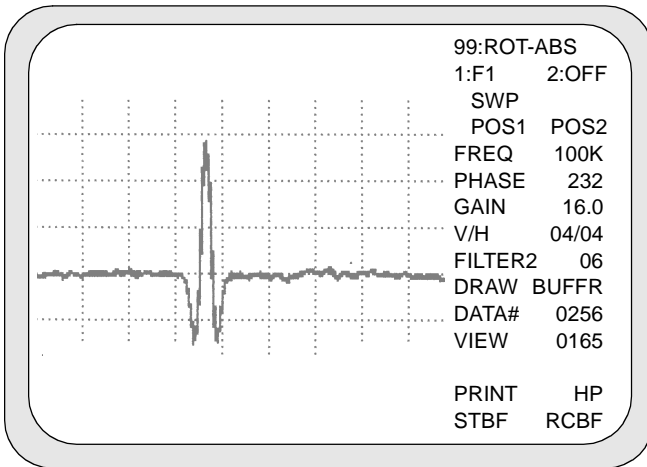
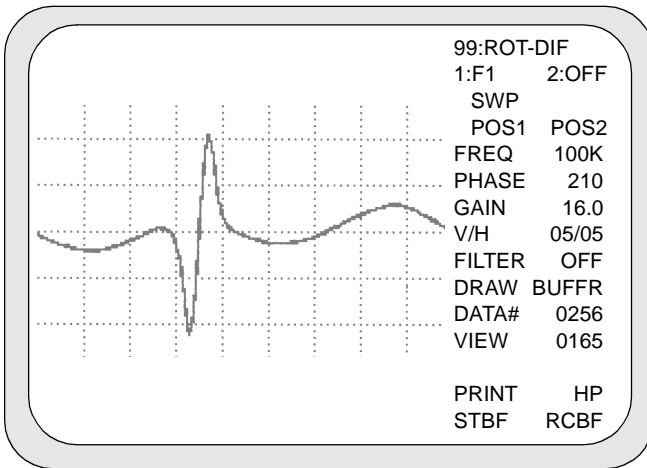

Figure 5-9 shows a signal using a differential coil probe without a filter. The low frequency rotational noise is due to probe angle or fill factor.

Figure 5-9. Differential Coil Signal without Filter



A differential coil signal with *FILTER 1* is shown in figure 5-10. The filter has removed the rotational noise that was shown in figure 5-9. The small negative lobes are a residual of the filter process.

Figure 5-10. Differential Coil Signal with FILTER 1

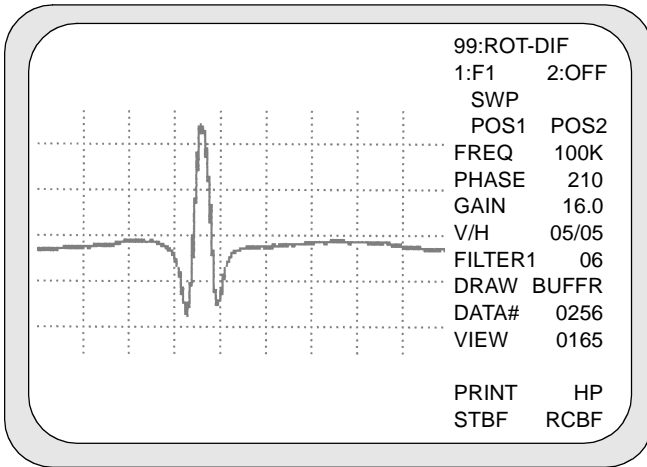

5.8 C-scan Example

Bore testing with rotating probes is the state-of-the-art method. The aircraft maintenance industry places considerable demand on signal processing and signal analysis, while reducing the “human factor.” Rotating probes and C-scan (cascaded scan) presentation are developments to answer this problem.

A rotating probe with overlapping axial indexing provides a helical scan to ensure 100% coverage. The image presented on the instrument is a C-scan in a pseudo 3D graphic representation of the internal bore. Comprehensive information on geometrical faults can be obtained from this signal image. Additionally, the flaw location within multi-layered assemblies becomes more straight forward.

The requirements for a C-scan example are listed in table 5-7.

Table 5-7. Requirements for C-scan Example with Scanner

Description	Part No.	Catalog No.
		
Indexing Rotating Probe Gun	N/A	2000-02-05
Rotating Bolthole Probe Frequency Range 50-400 kHz	A/MBH-SC**	921-8420

Table 5-7. Requirements for C-scan Example with Scanner (Cont.)

Description	Part No.	Catalog No.
Multi-Purpose Plate Standard Material-Aluminum	N/A	950-5700
Connections	–Connect the probe to the probe gun –REMOTE connector from probe gun to REMOTE on instrument –Amphenol 4-pin from probe gun to DIFFERENTIAL instrument connector.	

Complete the following steps in sequence to setup and perform a C-scan test.

Setup

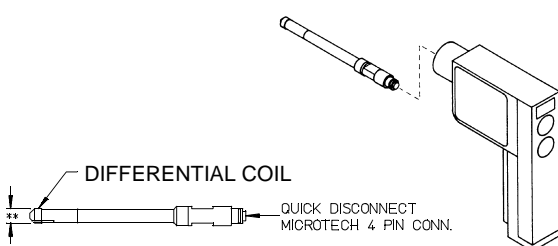
- step 1 Set the instrument variables as illustrated in table 5-11.
- step 2 Insert the probe into hole “O”.

- step 3 Start the probe gun to initiate the C-scan.
- step 4 Adjust the phase as necessary to minimize the lift-off effects.
- step 5 Insert the probe into hole “K”.

Figure 5-11. C-scan of Flaw Indications

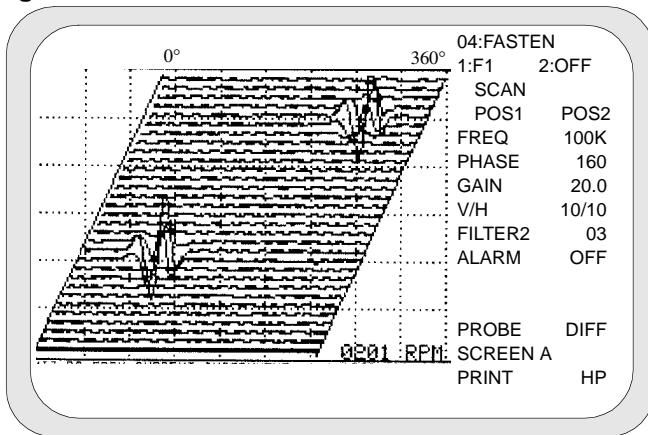

- step 6 Adjust the gain to get the desired response from the EDM notch.
- step 7 With the probe fully extended, insert the probe through hole “K”.
- step 8 Energize the gun and activate the indexing by pulling the trigger. This will cause the probe to travel through the hole with an axial travel of 0.025” per revolution.

The C-scan is halted by turning off the gun. This allows any portion of a fastener hole to be viewed with the DRAW BUFR function as seen in figure 5-12.

Figure 5-12. Buffered Data

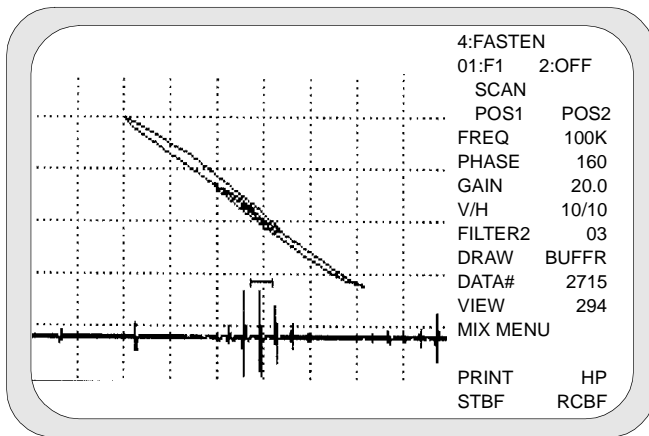

5.9 Signal Mixing Example

The mixing of eddy current signals from two or more test frequencies is a multiparameter technique used with multifrequency test methods. This technique combines the results of testing at more than one frequency to separate the test variables. As an example, the test variables can include the following effects.

- lift-off variation caused by probe wobble
- flaws caused by cracking or corrosion

By far, the most important aspect of the multiparameter technique is detecting and sizing flawed conditions in the presence of the undesirable effects of other variables. These undesirable effects, such as lift-off, are minimized or eliminated while retaining the signals from the desirable parameters, such as flaws.

The key is to select frequencies such that the ratio of $\frac{\text{Flaw Signal Amplitude}}{\text{Unwanted Signal Amplitude}}$ is greater for the primary frequency than for the subtracter frequency. Frequency selection that provides this difference will usually also provide a phase relationship between flaw signals and unwanted signals that differs between primary and subtracter frequencies.

In the analog instrumentation approach, the *X* and *Y* signal components of the subtracter

channel frequency are rotated and scaled such that the resulting unwanted signal matches the same signal in the primary frequency. The outputs of these primary and subtracter channels are then combined to produce a signal channel that has little or no response to the unwanted signals yet does produce a signal from the flaws of interest.

Better results can be achieved digitally. Rather than manually manipulating the signal with phase rotators and amplifiers, as with analog instrumentation, a computer can solve for the best result using mathematical techniques. The digital approach uses a set of simultaneous linear equations that describe the output signal channel as a mathematical combination of the primary and subtracter signal channels. Using least-squares techniques, the coefficients of the independent variables are determined based on the signals selected and the type of mix function used.

Generally, the two frequencies chosen for a mix operation have a ratio in the range of 2:1 to 4:1.

5.9.1 Mixing Out Lift-Off Signals

The requirements for mixing out lift-off signals are listed in table 5-8.

Table 5-8. Requirements for Mixing Out Lift-Off Signals

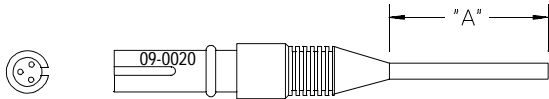
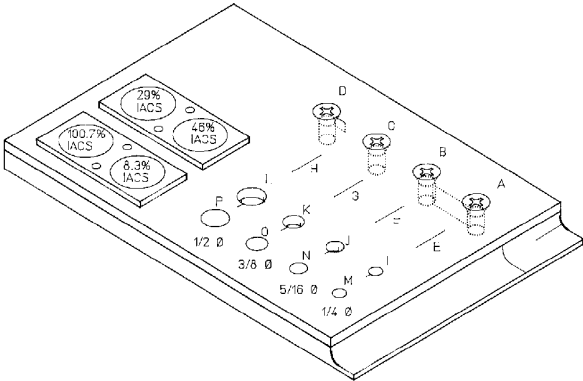
Description	Part No.	Catalog No.
		
<p>Probe-Detachable Tip Pencil—unshielded Frequency Range 50-500 kHz.</p>	DT20P	909-0020
		
<p>Multi-Purpose Plate Stan- dard Material-Aluminum</p>	N/A	950-5700
<p>Connections</p>	<p>Connect the probe to the instrument “DIFFERENTIAL” connector.</p>	

Complete the following steps in sequential order to perform this mix.

Setup

- step 1 Set the instrument variables to those shown in figures 5-13 and 5-14.

Figure 5-13. Set FREQ1

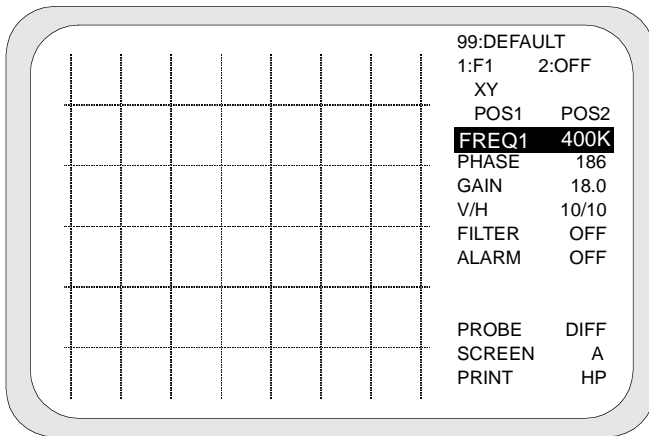
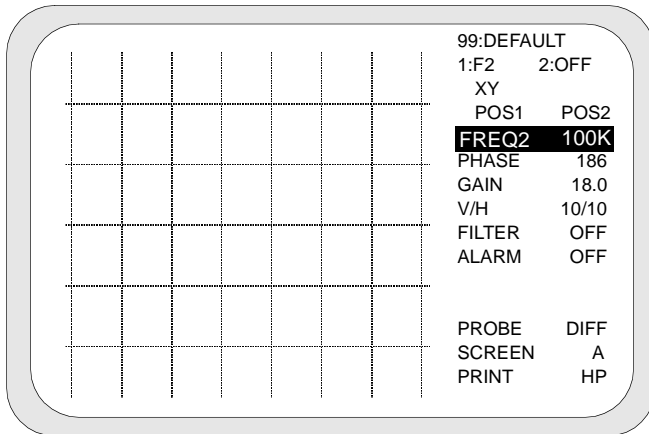
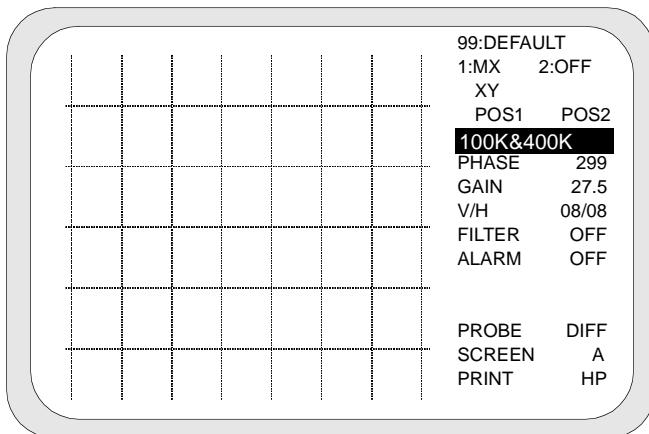

Figure 5-14. Set FREQ2



step 2 After setting up F1 and F2, notice that both frequencies are displayed as shown in figure 5-14.

Figure 5-15. Two-Frequency Mix Setup



- step 3 Adjust the phase as necessary for both F1 and F2, until the displayed lift-off signal is horizontal.
- step 4 Generate the signal of interest for mixing, in this case, a lift-off signal (see figure 5-16), by placing the probe on a defect-free area of the standard.

Figure 5-16. Lift-Off Signal

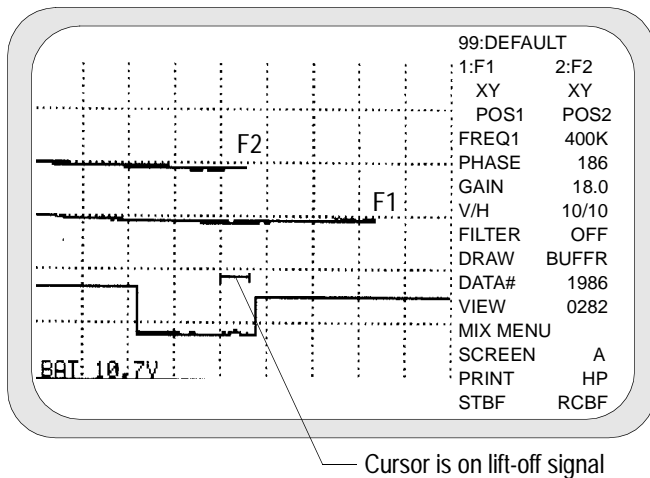

- step 5 Press the *BAL* button.
- step 6 Rock the probe from side to side to generate a horizontal lift-off signal.

- step 7 Press the *HOLD* button to view the *MIX MENU* line.



It doesn't matter which channel is being displayed, either F1 or F2.

- step 8 Use the <--*FUNC* or *FUNC*--> button to highlight the *DRAW BUFFER* line.
- step 9 Press any arrow button to draw (display) the buffered data.
- step 10 Use the <--*FUNC* or *FUNC*--> button to highlight the *DATA#* line. With *DATA#* highlighted, use the arrow buttons to move the cursor until the signal of interest is displayed.
- step 11 Use the <--*FUNC* or *FUNC*--> button to highlight the *VIEW* line. With the *VIEW* line highlighted, use any arrow button to adjust the width of the cursor. The width of the cursor corresponds to how much of the buffered data is viewed on the screen.

- step 12 Use the <--*FUNC* or *FUNC*--> button to highlight the *MIX MENU* line. With the *MIX MENU* line highlighted, press any arrow button to open the Mix Menu at the top of the data display.
- step 13 Use the <--*FUNC* or *FUNC*--> button to move within the Mix Menu.
- step 14 Highlight the M-1 (or M-2) function, and with the arrow buttons make sure that M-1 is displayed.
- step 15 Highlight the *CLEAR* function, and then activate the function with the up or down arrow button.
- step 16 Highlight the *SUPPRESS* function, and use the up or down arrow button to activate the function and perform the mix.
- step 17 Exit the Mix Menu by pressing the <--*FUNC* or *FUNC*--> button until the Mix Menu disappears.
- step 18 Highlight Display 1, and select *MX* for the display.

- step 19 Highlight Display 2, and select either F1 or F2 for the display shown in figure 5-17.



The mix residual should appear very small compared to the signal in Display 2.

- step 20 Press the *HOLD* button to return to normal MIZ-22 operation.

Figure 5-17. Mix Residual

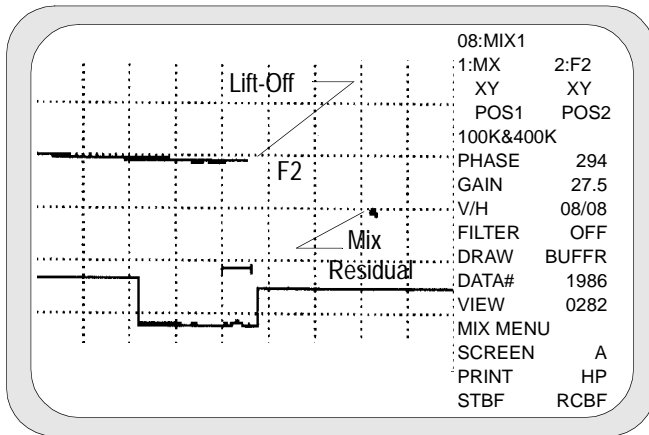

- step 21 Scan the probe over defects “E”, “F”, “G”, and “H”. Adjust the gain and V/H to attain the desired signal length. The display in figure 5-18 shows the lift-off signal mixed out.

Figure 5-18. MX Channel Display

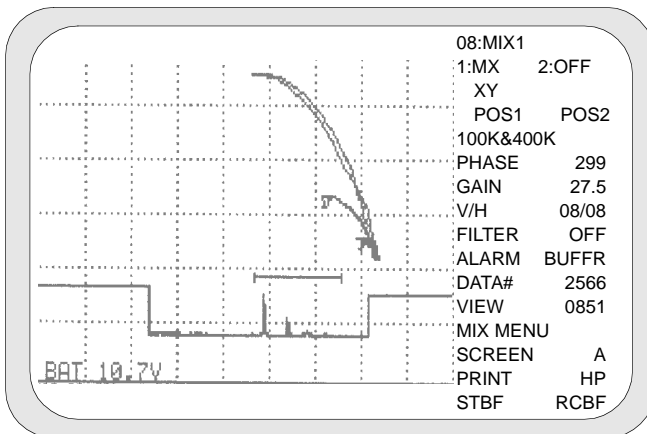

5.9.2 Mixing Out Varying Spacing

The requirements for mixing out a varying spacing are listed in table 5-9.

Table 5-9. Requirements for Mixing Out Varying Spacing

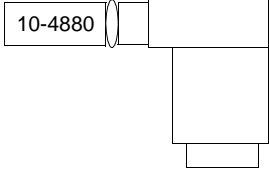
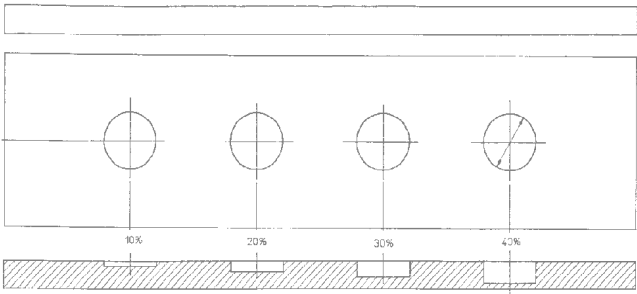
Description	Part No.	Catalog No.
		
Detachable Tip Driver/ Pick-Up Spot Probe Frequency Range 500 Hz- 30 kHz	DTDP-500-SP	910-4880
		
Spot Face Thickness Stan- dard Material-Aluminum	D#0433	N/A
Connections	Connect the probe to the instrument "REFLECTION" connector.	

Complete the following steps in sequential order to perform this mix.

Setup

- step 1 Set the instrument variables to those shown in figure 5-19.
- step 2 Follow the same steps used to mix out the lift-off signal in section 5.9.1 on page 5-35. Reference 5-19 through 5-21 for representative displays.

Figure 5-19. Response To Varying Gap Spacing Between Layers

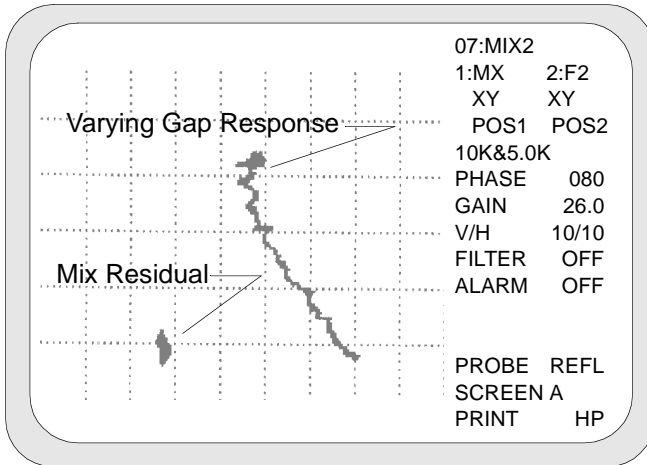

Figure 5-20. Flaw Response with Varying Gap Spacing

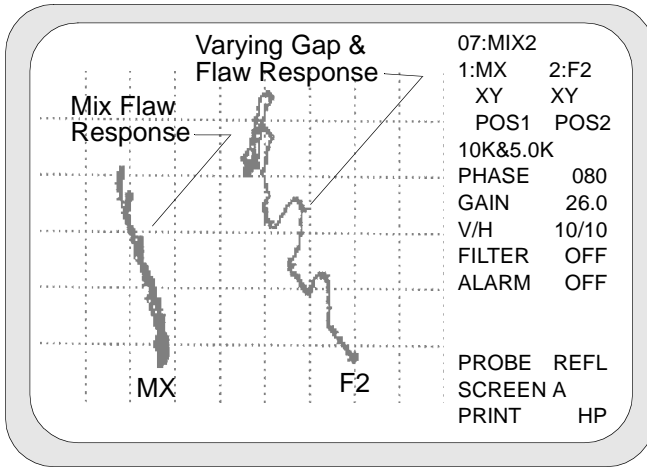
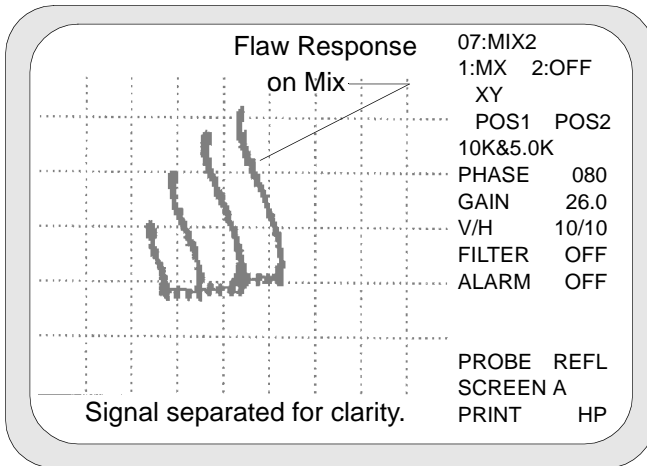

Figure 5-21. Flaw Response on Mix



5.9.3 Tube Support Signal Suppression Mix

The requirements for mixing out a tube support signal are listed in table 5-9.

Table 5-10. Requirements for Mixing Out Tube Support Signal

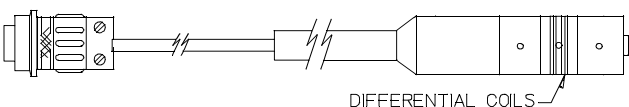
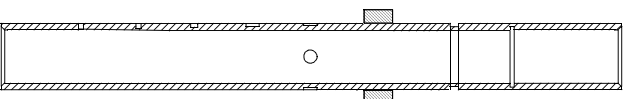
Description	Part No.	Catalog No.
	A-*BS	770-1602
	N/A	950-0030
ASME Standard with Simulated Tube Support Ring Material-Variou		
Connections	Connect the probe to the instrument "DIFFERENTIAL" connector.	

Complete the following steps in sequence to setup and perform a mix that suppresses the signal from a tube support.

Setup

step 1 Set the instrument variables according to table 5-9¹.

Table 5-11. Instrument Settings for Tube Support Suppression Mix

	F1	F2	MIX
FREQUENCY	400 kHz	100 kHz	400 & 100
PHASE	210	160	037
GAIN	36.0	24.0	20.0
V/H	08/08	10/10	07/07

step 2 Place the tube support ring over a defect free area of tubing. Also place the probe in a defect free area.

step 3 Press *BAL*.

step 4 Pull the probe past the support ring (at a rate not to exceed 1 ft/sec). Within six seconds, press *HOLD*.

1. These settings are for reference. Different settings can be used to achieve a similar result.

- step 5 Complete steps 8 through 20 in section 5.9.1 to perform the mix. The signals in figures and 5-22 and 5-23 show the results of the mix.

Figure 5-22. Tube Support Suppression Mix

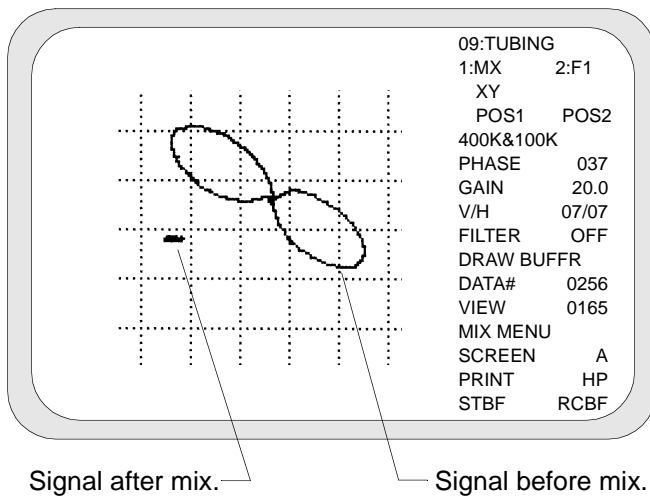
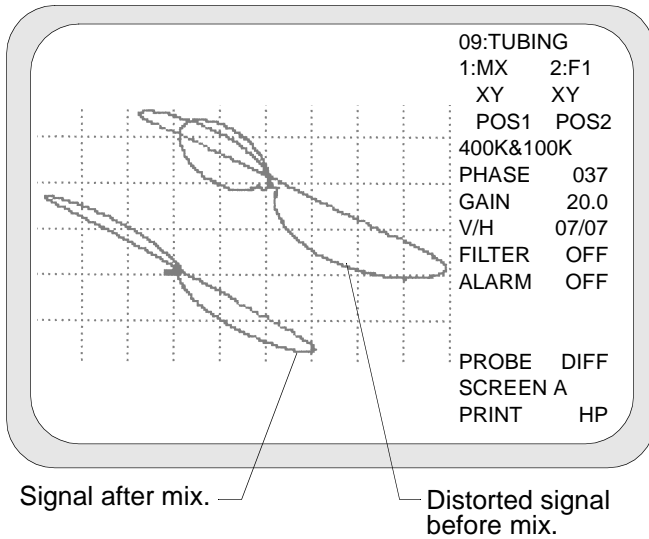

Figure 5-23. 100% Thru-Wall Signal at 400 kHz



Flaw is overlaid partially by support ring signal before mix.

5.10 Conductivity Measurement Example

The MIZ-22 has the ability to directly measure the conductivity of materials in a % IACS read-out. Variables such as geometry, temperature, and frequency selection determine an accurate conductivity measurement.

5.10.1 Geometry

Due to the edge effect, a surface area on the test material of at least 1/2" square is necessary. In general, it is not advisable to inspect any closer than 3.2 mm (1/8") from the edge of a part, depending on variables such as coil size and test frequency. Curvature of the test piece can also affect the measurement.

Another consideration is the minimum required thickness of the material. The minimum thickness required increases as the conductivity value decreases. For help in determining the minimum thickness, reference the information in equation 4-3.

When setting up the instrument as well as during a test, keep the probe as perpendicular to the test piece as possible.

5.10.2 Temperature

As the probe changes in temperature, small geometrical and electrical effects will change the conductivity reading. For best results, the test piece, probe, and standards should be kept at the same temperature for the duration of the setup and test.

5.10.3 Frequency Selection

Traditionally, conductivity measurements have often been performed at 60 kHz. The MIZ-22 offers a choice of three frequencies that can enhance the accuracy of the measurement. In general, to obtain the best response, use a higher frequency for a material with a lower conductivity value.

The requirements for a conductivity measurement test are listed in table 5-14.

Table 5-12. Requirements for Conductivity Measurement

Description	Part No.	Catalog No.
		
Driver/Pick-Up Spot Probe 0.375" diameter with 6-ft. cable	T/D-※-SP	931-0200
5 Certified Conductivity Coupons—100.4, 29.3, 8.1, 3.332, and 1.047% IACS	It is recommended that the conductivity coupons you use are fairly close to the instrument's preset values.	
<p>These options for standards are available from Zetec if needed.</p> <div style="border: 1px solid black; padding: 5px; text-align: center;">  </div>		
5-Piece Conductivity Coupon Set—Certified	Dwg. No. 2-4705	

Table 5-12. Requirements for Conductivity Measurement (Cont.)

Description	Part No.	Catalog No.								
										
Multi-Purpose Plate Standard with 5-Piece Certified Conductivity Coupon Option Material—Aluminum		950-5701								
<table border="1" style="width: 100%; height: 100%;"> <tr> <td style="width: 25%; text-align: center;">+</td> <td style="width: 25%;"></td> <td style="width: 25%;"></td> <td style="width: 25%;"></td> </tr> <tr> <td style="text-align: center;">+</td> <td style="text-align: center;">009</td> <td style="text-align: center;">.006</td> <td style="text-align: center;">003</td> </tr> </table> 	+				+	009	.006	003		
+										
+	009	.006	003							
Paint Thickness Simulation Standard Material—Vellum	N/A	950-5800								
Connections	Connect the probe to the instrument "REFLECTION" connector.									

Complete the following steps in sequence to setup, calibrate, and perform an alloy sorting test.

Setup

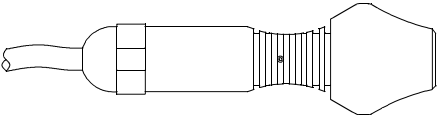
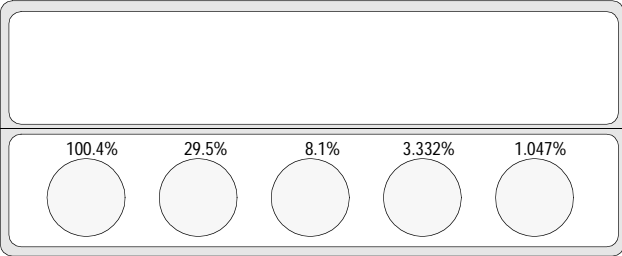
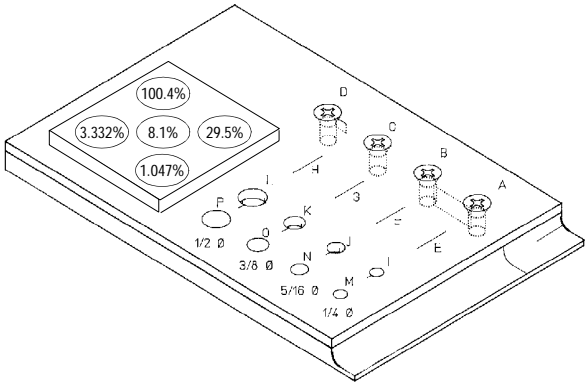
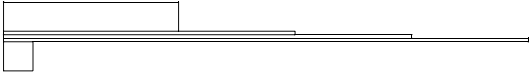
- step 1 Set the instrument variables according to your conductivity standards and shim. Figure 5-24 is shown as an example of a possible setup. More information about changing the SET# values is on page 4-47.

Figure 5-24. Default %IACS Display

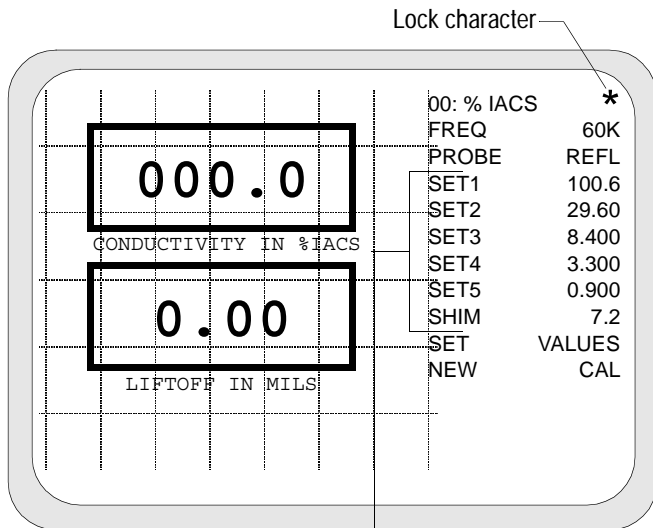

These values will vary depending on your conductivity standards and shim.

- step 2 Highlight the *NEW CAL* line as shown in figure 5-25.
- step 3 Use the *LEFT* or *RIGHT* arrow button to toggle through the set values until *SET1* is shown on the display as shown in figure 5-25.
- step 4 Place the probe on the corresponding conductivity standard and visually verify the value on the instrument and the standard is the same.

Figure 5-25. Calibration Display

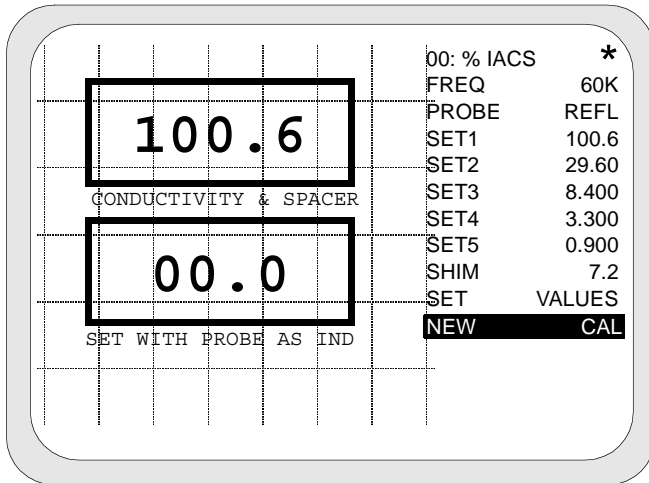

- step 5 With the probe remaining on the standard, press the *UP* or *DOWN* arrow button to set the calibration point. An audible beep verifies the calibration is set.
- step 6 Press the *LEFT* or *RIGHT* arrow button until the *SHIM* value is highlighted as shown in figure 5-26.

Figure 5-26. Shim Value Display

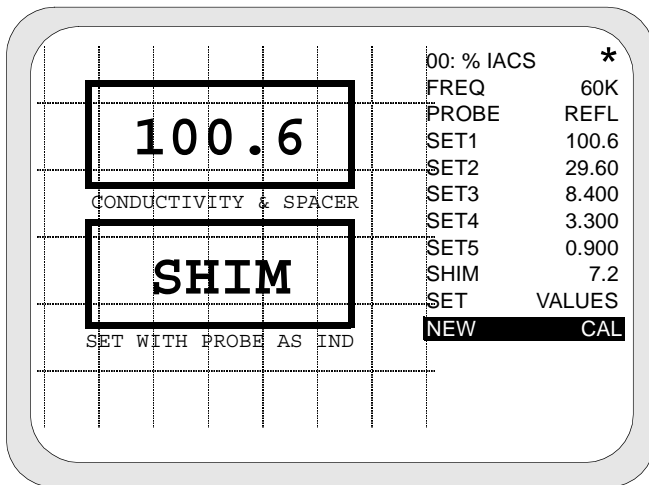

- step 7 Place the probe and the selected shim on the conductivity standard. Visually verify the % IACS value with the selected shim are the same for the instrument and the standard.

- step 8 With the probe remaining on the standard, press the *UP* or *DOWN* arrow button to set the calibration point. An audible beep verifies the calibration is set.

- step 9 Repeat steps 3 through 8 for *SET2* through *SET5*.

- step 10 Use the *LEFT* or *RIGHT* arrow button to toggle until the *AIR* value is displayed as shown in figure 5-27.

Figure 5-27. Air Value

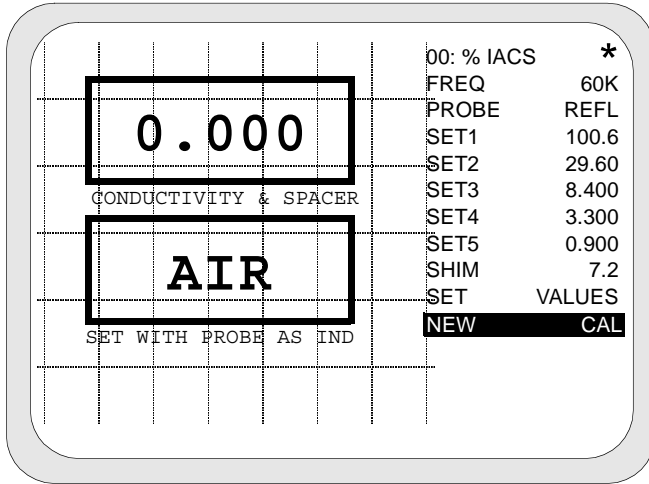

- step 11 After all of the SET# values have been calibrated, hold the probe in the air and press the *UP* or *DOWN* arrow button to set the calibration point at zero as shown in figure 5-27. An audible beep verifies the calibration is set.
- step 12 Use the <--*FUNC* or *FUNC*--> button to deselect the *NEW CAL* function, which exits the calibration procedure.

The MIZ-22 is now ready to proceed with conductivity measurement.

5.11 Direct Coating Thickness Measurement Example

The requirements for a coating thickness test are the same as for the conductivity measurement example, which are listed in table 5-14. Follow the same procedure as the conductivity measurement example to setup the test. The thickness value, in mils, is displayed in the box below the conductivity value.

After the *SHIM* (spacer) value is calibrated, you can directly measure a coating thickness with the MIZ-22 at the same time as a conductivity measurement. During calibration, a known value is used to represent a nonconductive coating such as paint thickness. This known value should be somewhat close to the thickness that is expected during the test. Examples of items used as shims could be a single piece of paper, about 3.0 mils (0.003") thickness or Teflon tape of varying thickness.

Higher thickness readings may be more accurate at a lower test frequency. The optimum frequency should be determined by experimenting with the test piece.

*5.0 Application Examples
Sample Setup Data Worksheet*

Test Name _____

Probe P/N _____

Standard P/N _____

	: _____
	1: _____ 2: _____
	XY _____
	POS1 POS2 _____
	FREQ _____ K
	PHASE _____
	GAIN _____
	V/H _____
	FILTER _____
	ALARM _____

	PROBE _____
	AUTCLR _____
	PRINT _____

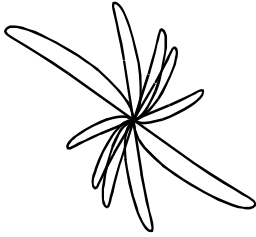

Index

Symbols

% IACS 5-50

A

A/B screen 4-35

Aircraft skin corrosion example 5-8

Alarm 4-24

Alloy sorting example 5-11

Analog Output 2-7

Analog outputs 4-62

Application examples 5-1

AUTCLR 4-35

Auto clear 4-35

Automatic turn-off 4-59

Auxiliary features 4-59

B

- Balance button 2-6
- Basic Instrument Specifications
 - Frequency Range 2-14
 - Memory 2-15
- Battery life 4-61
- Battery pack 4-60
- Battery voltage readout 4-59

C

- C scan example 5-28
- CHNG CENT 4-24
- CHNG SIZE 4-24
- CLEAR 4-31
- Clear button 2-5
- Command (ASCII) 4-64
- Computer interface 4-62
- Conductivity measurement 4-40, 5-52
- Conductivity sorting example 5-50
- Copyright 1-3
- Countersink example 5-17

D

- Data buffer 4-26
- Data enhancement mix 4-31
- DATA# 4-26, 4-31
- DIFF 4-34
- Digital conductivity 4-40
- Dimensions 2-18

Display parameters 4-12
DRAW BUFFR 4-26

E

Environmental factors 2-19
Equipment cases 2-10
Equipment supplied with MIZ-22 2-8

F

Fastener hole example 5-14
Filter 4-22
FORTH commands 4-66
Frequency 4-14
Front panel connections 3-5
Front panel controls 2-2
 display screen 2-2
Function and direction arrows 2-4
Functional block diagram 2-8

G

Gain 4-18
General Description 1-1

H

Hazardous locations usage 2-20
HOLD 4-30
Hold button 2-6
HOLD mode 4-26

Humidity 2-19

I

Installation 3-1

Instrument setup 4-4

L

Least squares data suppression mix 4-31

Lighting 2-19

Logic Level 3-8

M

Maintenance Agreement 1-4

Mix menu 4-30

MIX-1 4-32

MIX-2 4-31, 4-33

Mixing out lift-off signals 5-35

Mixing out varying spacing 5-43

N

NEW CAL menu line in % IACS mode 4-50

Ni-Cad D cell batteries 4-60

Nickel Cadmium (Ni-Cad) D cells 4-60

O

ON/OFF button 2-5

Operating Temperature Range 2-19

Operation 4-1

Optional accessories for the MIZ-22 2-9

P

Phase 4-16

Pixels 2-2

Power connector 3-3, 3-9

Power Receptacle 2-7

Power requirements 3-2

Power-up commands 4-64

Print a stored image

 how to 4-11

PRINT SCRN 4-39

Probe Connector

 Differential 3-6

 Single 3-6

Probe connectors 2-6, 3-5

Probe for conductivity test 4-44

Probe gun interface 4-68

Probe Type 4-34

Probes 2-9

R

Rating Label 2-20

Raw data 4-63

REFL 4-34

Reflection probe for conductivity testing 4-44

Remote 2-7

REMOTE connector 4-62

Remote connector 3-7

Remote Connector Pin-Out 3-7
Return policy 1-4
Rotating probe gun 2-10
RS-232C computer interface 4-62

S

Sample setup data worksheet 5-60
Sampling rate 2-11
SAVE 4-31
Screen A/B 4-35
Screen memory 4-36
Self-Test 4-70
self-test 3-4
Set values menu line in % IACS mode 4-47
Set# 1-5 in % IACS mode 4-47
Setup number 4-5
Signal mixing 2-17
Signal mixing example 5-33
SING 4-34
Specifications 2-11
 Alarm 2-16
 Battery Pack 2-18
 Dimensions 2-18
 Display 2-15
 Filter 2-16
 Frequency range 2-14
 Gain adjustment range 2-14
 Inputs 2-17
 Outputs 2-17
 Phase 2-14
 Power Requirements 2-18

Storage battery 3-3
Storage Temperature Range 2-19
Store-and-View Screen Image Buffer 4-8
SUPPRESS 4-31
Surface crack example 5-5
System Description 2-1

T

T/D-*-SP 5-52
Test design considerations 5-1
Turning on unit and backlight 3-4, 4-2

U

U.L. approved accessories 2-21
Unpacking 3-1
UP or DOWN arrow key 4-6

V

V and H analog outputs 4-62
V and H connectors 3-9
V and H outputs 2-2
V/H ratio 4-20
VIEW 4-27
View a stored image
 how to 4-10

W

Warning Labels 2-20

Warranty 1-2

Y

Y-T sweep 4-63

Z

Zetec Micro Buffer 4-39