

Operating Instruction

TKZ: 315 002 000 001

Version: 01 / 2014

Battery Tester- /Charger-/Discharger

BT2000

0-40V / 0-40A

Vers.-Nr.: 6625-12-333-0892

TKZ: BT2000-040009-0255

Software-Version 20.013CT

Version: 17.09.2007



COPYRIGHT © 2001-2014 by
Nortec Electronics GmbH & Co. KG
An der Strusbek 32 B
D-22926 Ahrensburg
Tel.: +0049 / 4102 / 42002
FAX +0049 / 4102 / 42840
Email: info@nortec-electronics
Web: www.nortec-electronics.de

FRONT VIEW

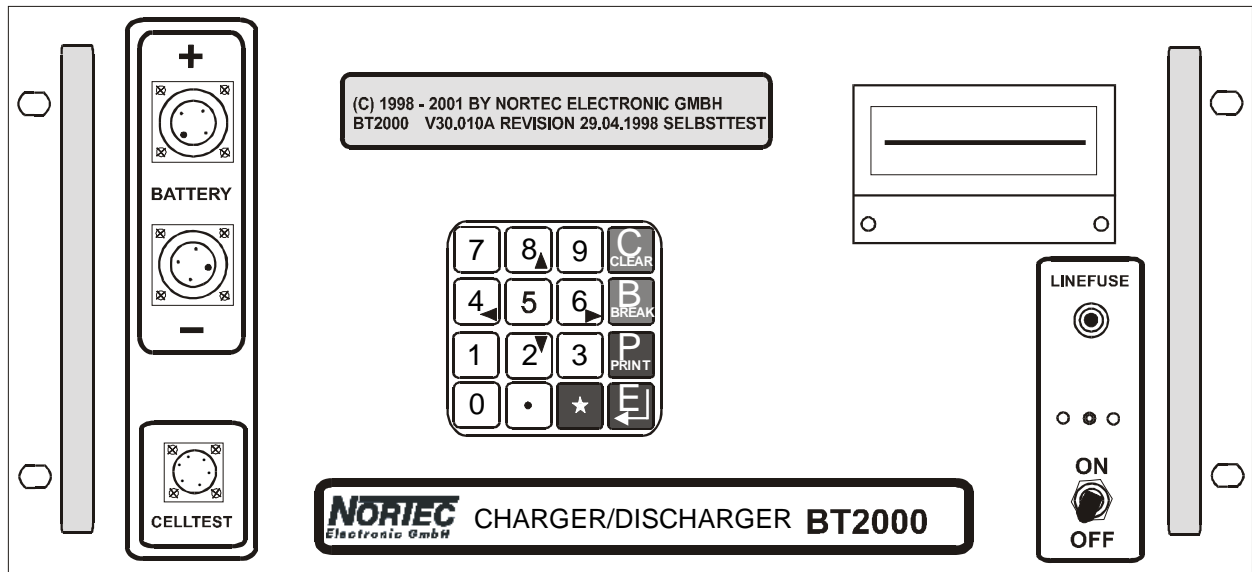

List of Contents

1	General Information.....	4
1.1	Usage	4
1.2	Technical Data	5
2	Operation	7
2.1	General Information.....	7
2.1.1	Keyboard Functions	7
2.2	Description of Function.....	8
2.2.1	Starting the BT2000	8
2.2.1.1	Power-On Test	8
2.2.2	Starting the Program	9
2.2.3	Finishing a Program	10
2.3	Structure of display indications	11
2.3.1	Program-No.	11
2.3.2	Step-No.....	11
2.3.3	Name of the program step.....	11
2.3.4	Battery Voltage.....	11
2.3.5	Current.....	11
2.3.6	Capacity.....	12
2.3.7	Time.....	12
2.3.8	Battery Temperature	12
2.4	Programs Overview.....	13
2.5	Description of programs	14
2.5.1	Program 0: Discharge of batteries with constant current.....	14
2.5.1.1	Parameter inputs	14
2.5.1.2	Program steps	14
2.5.1.3	Monitoring functions	14
2.5.2	Program 1: Analysis of vented NiCad-batteries	16
2.5.2.1	Parameter inputs	16
2.5.2.2	Program steps.....	16
2.5.2.3	Monitoring functions	17
2.5.3	Program 2: Charging of vented NiCad-batteries	19
2.5.3.1	Parameter inputs	19
2.5.3.2	Program steps.....	19
2.5.3.3	Monitoring functions	20
2.5.4	Program 3: Test-cycle for sealed lead-acid-batteries	22
2.5.4.1	Parameter inputs.....	22
2.5.4.2	Program steps.....	22
2.5.4.3	Supervisory functions	24
2.5.5	Program 4: Charging of sealed lead-acid-batteries	27
2.5.5.1	Parameter inputs	27
2.5.5.2	Program steps.....	27
2.5.5.3	Supervisory functions	28
2.5.6	Program 5: Charging of sealed NiCad-batteries	31
2.5.6.1	Parameter inputs	31
2.5.6.2	Program steps.....	31
2.5.6.3	Monitoring functions	32

2.5.7	Program 6: Constant-current (I)-charging, time limited	33
2.5.7.1	Parameter inputs	33
2.5.7.2	Program steps	33
2.5.7.3	Monitoring functions	33
2.5.8	Program 7: Constant-current - constant-potential (IU)-charge, time limited / non time limited	35
2.5.8.1	Time-limited IU-Charge	35
2.5.8.1.1	Parameter inputs	35
2.5.8.1.2	Program steps	35
2.5.8.1.3	Monitoring functions	36
2.5.8.2	Non-Time-Limited IU-Charge.....	36
2.5.8.2.1	Parameter inputs	36
2.5.8.2.2	Program steps	37
2.5.8.2.3	Monitoring functions	37
2.5.9	Program 8: Maintenance of NiCad-Batteries Code C (1000Ah)	39
2.5.9.1	Parameter input.....	39
2.5.9.2	Program steps	41
2.5.9.3	Monitoring functions	42
2.5.10	Program 9: Maintenance of NiCad-Batteries Code F (2000Ah).....	45
2.5.10.1	Parameter inputs	45
2.5.10.2	Program steps	47
2.5.10.3	Monitoring functions	50
2.5.11	Program P: Printer Usage and Cell-Voltage Measurement.....	52
2.5.11.1	Automatic printout during program run.....	53
2.5.11.2	Manual printout without activated program	56
2.5.11.3	Manual printout without automatic protocol generation selected	58
2.5.11.4	Additional Protocol during Automatic-Protocol-Generation of an active program.....	60
2.5.11.5	Paper and ink ribbon Replacement.....	61
2.5.11.6	Printer test.....	61
2.5.12	Program *: Setting of date and time.....	63
3	Fault-Messages.....	64
3.1	Hardware failures	64
3.2	System failure	65
3.3	Battery faults	65
4	Installation.....	67
5	Definitions	68
5.1	Battery, sealed	68
5.2	Battery, vented	68
5.3	Rechargeable silver-zinc-battery	68
5.4	Charging/Discharging-Threshold-Voltage	68
5.5	Rated voltage.....	68
5.6	Rated Capacity = C_5	68
5.7	Rated Current or $0.2 C_5$ (A)	69
5.8	Cell voltage	69
5.9	Analysis cycle / Maintenance cycle.....	69
5.10	Charge	69

1 General Information

1.1 Usage

The Equipment is used to charge and analyze the dischargeable capacity of batteries of following technologies and types:

- Vented NiCad-batteries with rated voltages of 1.2 to 26.4V and rated capacities greater or equal to 4Ah
- Sealed NiCad-batteries with rated voltages of 1.2 to 31.2V and rated capacities greater or equal to 2.5Ah
- Vented lead-acid-batteries with rated voltages of 2 to 24V and rated capacities greater or equal to 10Ah
- Sealed lead-acid-batteries with rated voltages of 2 to 24V and rated capacities greater or equal to 1Ah.
- Rechargeable silver-zinc-batteries with rated voltages of 1.5 to 24V and rated capacities greater or equal to 5Ah.

In addition the equipment provides following capabilities:

- DC-Power-Supply in combination with a rechargeable battery
- Battery-Charger with following characteristics:
 - Constant-Current (I) -Charge
 - Constant-Potential (U) -Charge
 - Constant-Current-Constant-Potential (IU)-Charge
 - Constant-Current-Constant-Potential-Constant-Current (IUI) -Charge
- Battery-Discharger discharging a battery with constant current down to a previously entered discharging-threshold-voltage

The various parameters to be entered are free selectable considering following limitations, related to the technical structure of the equipment:

- Charging voltage range of 0.1V to 36V in steps of 0.01V
- Discharging voltage range of 0.1V to 30V in steps of 0.01V
- Charging current range of 0.5A to 40A in steps of 0.01A
- Discharging current range of 0.5A to 40A in steps of 0.01A
- Discharging voltage threshold range of 0.5V to 30V in steps of 0.01V

To record the various analysis and charging results the equipment is provided with a printer, which on demand automatically prints the program specific data and results.

1.2 Technical Data

Electrical input and output parameters

- Supply voltage	:	AC 230V \pm 10 % (single phase)
- Input frequency	:	45 to 66 Hz
- Charging current	:	0.5 A to 40A
- Discharging current	:	0.5 A to 40A
- Charging voltage	:	0.1 V to 40V
- Discharging voltage	:	0.1V to 30V
- Discharging threshold voltage:	:	0.1V to 30V

Operating temperature

The function of the BT2000 is ensured within a temperature range of -15 °C to +45 °C.

Accuracy of the output parameters

The output parameters show following maximum tolerances:

- charging and discharging currents =0.5 A	:	< \pm 50mA
- charging and discharging currents =40 A	:	< +300/ - 50mA
- charging voltages	:	< \pm 50 mV
- shut down voltages	:	< \pm 50 mV
- change over voltages	:	< \pm 50 mV
- discharging threshold voltages	:	< \pm 50 mV
- cell voltage measurement	:	< \pm 10 mV
- charging and discharging periods	:	< \pm 0.5 %
- Temperature measurement	:	< \pm 2°C

The accuracy of the displayed and printed parameters corresponds to the a.m. values.

Providing the equipment is operated in the temperature range -15°C to +40 °C, the accuracy of the output parameters is guaranteed for a period of 2 years from date of delivery.

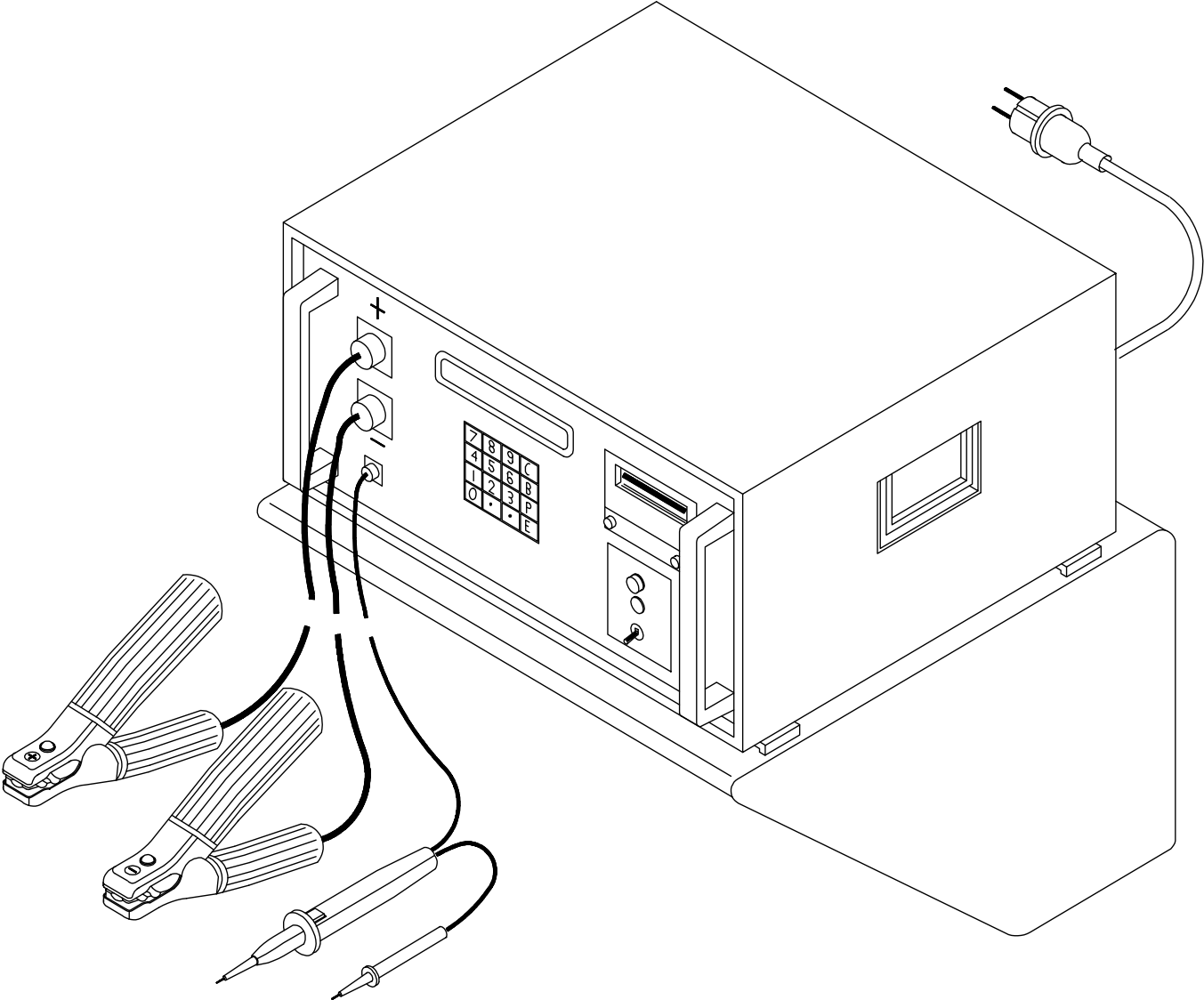

Figure 1: Battery-analyzer and charger BT2000

2 Operation

2.1 General Information

The BT2000 can only be operated after connecting a rechargeable battery correctly to the output terminals.

2.1.1 Keyboard Functions

Pushbutton	C	=	CLEAR	Clearing the actual Input
Pushbutton	B	=	BREAK	Breaking / terminating the actual program
Pushbutton	P	=	PRINT	selecting automatic / additional protocol printout
Pushbutton	E	=	ENTER	Entering the actual data input
Pushbutton	*	=	special program	Setting date and time
Pushbutton	.	=	Decimal point	Parameter input
Pushbuttons	0-9	=	numbers 0-9	Parameter and Program-No.

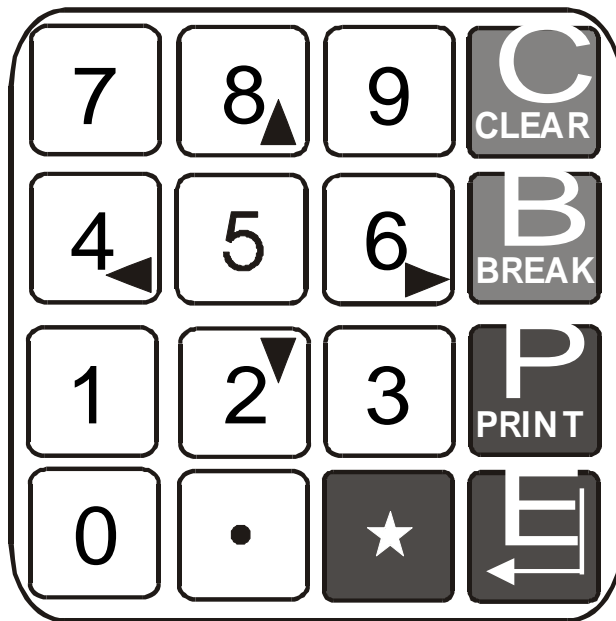

Figure 2: Keyboard

2.2 Description of Function

2.2.1 Starting the BT2000

The standard operating procedure, valid for all programs is described below:

- connect battery
- toggle power switch to position ON

Immediately after switching on the equipment a self test is performed.

2.2.1.1 Power-On Test

After switching on the supply voltage the display shows following information:

- Copyright of the manufacturer
- Type designation
- Date of issue and version number of software
- Indication TEST while self check is active

**COPYRIGHT 2002 BY JRR NORTEC
BT2000 V 20.013-CT 24.05.02 TEST**

After self check is performed with satisfying results:

**COPYRIGHT 2002 BY JRR NORTEC
BT2000 V 20.013-CT 24.05.02 TEST OK**

Additionally the end of the self check is indicated by a short audible alarm, signaling that the equipment is ready for operation.

In case of detected malfunction the display shows the fault indication:

**FAILURE: EQUIPMENT
KEYBOARD**

The fault indications and possible reasons are described in chapter 2.6.1. All fault messages appear in English language.

NOTE

In case of a fault further functions are disabled until the fault reason is removed.

After an error free self check the operator has to decide which language shall be used for further communication. The following display indicates the available languages and the keys to be actuated for selection:

**COPYRIGHT BY JRR NORTEC
DEUTSCH = 0 ENGLISH = 1**

NOTE

All inputs except the language selection, the decision for automatic printout or not, and the decision for continuing or terminating the program in case of a fault have to be acknowledged by actuating the key E = ENTER

2.2.2 Starting the Program

After selecting the desired language (In this documentation only the selection "English" is described) an information about the 12 selectable programs and the actual time is displayed

SELECT PROGRAM (0 - 9,P,*) ? 23:44:55

After starting the program by pressing the button "E" = ENTER the polarity of the connected battery is tested. For this test the battery voltage must be higher than 0.1 V. Fully discharged batteries or batteries with reversed polarity activate following display message:

SELECT PROGRAM (0 - 9,P,*) ? 23:44:55
BATTERY <0,1V CONTINUE = 1 END = 0

Before continuing by entering "1" check the polarity of the battery. A reversely connected battery (positive connector to negative battery terminal) will be destroyed. A deep discharged battery or a battery with reversed terminal voltages will be properly charged if the battery is not internally defect.

This is the last test to prevent destruction of a battery accidentally connected with the wrong polarity.

Now the program parameters have to be entered. The appropriate input sequences are described in chapter 2.5.

The last point of the parameter input is the decision to run the program with automated protocol printout or without. This is requested with following display message:

P1: PARAMETER INPUT
START: 1 WITH PRINT: P NEW: 0

- Actuating the button 1: Start of the program without printed protocol
- Actuating the button P: System requests further data input for protocol identification:
 - Battery-No. (max. 9 digits), e.g.: serial No. of the battery
 - Operator No.: (max. 9 digits), e.g. staff No. of the operator

After entering the protocol data the program automatically starts.

- When actuating the button 0 the display indication returns to the first parameter request

P1: PARAMETER INPUT
NUMBER OF CELLS? 00

During entering the battery, program, and protocol parameter the user is guided via the display indications.

For further details on the program specific parameters please refer to chapter 2.5.

Before actually starting the program or preceding the next program step further tests are imparted, e.g.:

P1: START OF PROGRAM START CHECK - PLEASE WAIT

Depending on the actual equipment status this indication is invisible or can be seen for several seconds.

A fault detected during the test is indicated with one of the fault indications explained in chapter 3.2 and 3.3. The fault reason has to be removed before the program can be continued.

Furthermore before starting the program the battery voltage is checked (>0.1 V). This check is continued during run of program, to detect a fast voltage-drop of possibly sulfated batteries during discharge procedures.

- If the battery voltage is > 0.1 V the program continues.
- If the battery voltage is < 0.1V the display shows following message:

P1: START OF PROGRAM BATTERYVOLTAGE < 0.1V? CONTINUE = 1 END = 0

Having selected the automatic printout each program step is printed with its program specific predefined parameters.

Wrong inputs can be corrected by actuating the key C = CLEAR before pressing the ENTER-key. Now in the cleared input field the corrected data can be entered.

2.2.3 Finishing a Program

A program can be finished or interrupted as described below:

Automatically after performing all assigned program steps within the relevant safety criteria. In this case the display may show an indication similar to the following:

PROGRAM END
12.30V --.--A 060.0AH +01:30 28.4°C

Automatically by program shut down due to an activated safety criteria. In this case the display may show an indication similar to the following:

FAILURE:
BATTERY TEMPERATURE TO HIGH

Manually by actuating the key B=BREAK. This time the display shows:

PROGRAM INTERRUPT
CONT = 1 END = 0

Actuating the key 1 continues the program at that position where it was interrupted before.

Actuating the key 0 finally finishes the program. Having selected the automatic printout all actual program and battery data, valid just before finishing the last program step, will be printed followed by:

PROGRAM END
12.30V --.--A 060.0AH +01:30 28.4°C

2.3 Structure of display indications

The display indication and printout structure is principally identical for all programs and program steps.

2.3.1 Program-No.

The program numbers are indicated in the upper row of the display as P0:P9: , e.g.:

```

P1: S1: DISCHARGE 1
12.30V      40.00A      060.0AH      +01:30      28.4°C

```

2.3.2 Step-No.

The step number is indicated in the upper row of the display as S1:Sn. The amount of program steps varies depending on the used program (please refer to the description of the programs):

```

P1: S1: DISCHARGE 1
12.30V      40.00A      060.0AH      +01:30      28.4°C

```

2.3.3 Name of the program step

The name of the program step denominates the actual function performed during the program step (for further details please refer to the description of the programs):

```

P1: S1: DISCHARGE 1
12.30V      40.00A      060.0AH      +01:30      28.4°C

```

2.3.4 Battery Voltage

The voltage indication (V) shows permanently the actual measured value, so at the end of the program the display shows the "off load voltage" of the battery:

```

P1: S1: DISCHARGE 1
12.30V      40.00A      060.0AH      +01:30      28.4°C

```

2.3.5 Current

During charging steps the charging current (A) and during discharging steps the discharging current (A) is indicated:

```

P1: S1: DISCHARGE 1
12.30V      40.00A      060.0AH      +01:30      28.4°C

```

2.3.6 Capacity

During charging steps the already charged capacity (Ah) and during discharging steps the already discharged capacity (Ah) is indicated.

The capacity indication is provided with an automatic range selection with three different ranges.

Range 0 to 9.999AH:

P1:S1: DISCHARGE 1
14.05V 40.00A **9.999AH** +00:15 28.4°C

Range 10.00 to 99.99AH:

P1:S1: DISCHARGE 1
13.35V 40.00A **99.99AH** +02:30 28.4°C

Range 100 to 999.9AH:

P1:S1: DISCHARGE 1
09.40V 40.00A **999.0AH** +25:00 28.4°C

2.3.7 Time

Time indications are displayed in two variations:

Determined periods (time limited functions):

Determined periods (e.g. **TOPPING** charge 90 minutes) count down to zero starting with the determined value. They are identified by a leading “-” sign.

P2:S2: **TOPPING CHARGE**
12.30V 40.00A 044.0AH -01:06 28.4°C

Non-Determined periods:

All other time indications identified with a leading “+” sign start with zero at a certain start criteria (e.g. start of a discharging period to be stopped at a certain voltage threshold) and display the time passed until the specified stop criteria is achieved:

P0:S1: DISCHARGE
12.30V 40.00A 044.0AH **+01:06** 28.4°C

2.3.8 Battery Temperature

The battery temperature (°C) is measured only if both temperature sensors are connected. Only the value of the battery terminal with the higher temperature is indicated.

P0:S1: DISCHARGE
12.30V 40.00A 044.0AH +01:06 **28.4°C**

If the temperature sensors are not connected following display is provided:

P0:S1: DISCHARGE
12.30V 40.00A 044.0AH +01:06 **--.°C**

2.4 Programs Overview

The BT2000 is provided with following programs:

Program 0: Constant current discharging

Program 1: Analysis of vented Nickel-Cadmium-Batteries

Program 2: Charging of vented Nickel-Cadmium-Batteries

Program 3: Maintenance of PB-Batteries

Program 4: Charging of BP-Batteries

Program 5: Charging of sealed Nickel-Cadmium-Batteries

Program 6: Constant-current (I)-charging, time controlled

Program 7: Constant-current-constant-potential (IU)- charging, time controlled / non time controlled

Program 8: Maintenance of NiCad-Batteries Code C (1000Ah)

Program 9: Maintenance of NiCad-Batteries Code F (2000Ah)

Program P: Print routines / cell-voltage measurement

Program *: Setting date and time

2.5 Description of programs

2.5.1 Program 0: Discharge of batteries with constant current

The program is used to determine the dischargeable capacity:

SELECT PROGRAM (0 - 9,P,*) ? 0 15:44:55
P0: DISCHARGE

2.5.1.1 Parameter inputs

Following parameters may be entered:

Rated voltage (0.01 - 30V in increments of 0.01V):

P0: PARAMETER INPUT
NUMBER OF CELLS? 00 CELLS

Rated capacity (0.1 999.9 Ah in increments of 0.1Ah):

P0: PARAMETER INPUT
CAPACITY: 000.0AH

Discharging current (0.01-40A in C₅; S5: I-CHARGE 2

P0: PARAMETER INPUT
CURRENT: 00.00A

Turn off voltage (0.01 - 30V in increments of 0.01V):

P0: PARAMETER INPUT
Voltage: 00.00V

2.5.1.2 Program steps

The program consists of steps.

Step S1: DISCHARGE

Discharging with the determined current until the previously entered discharging threshold is achieved.

P0:S1: DISCHARGE
11.30V 40.00A 060.0AH +01:00 28.4°C

2.5.1.3 Monitoring functions

No additional monitoring functions available.

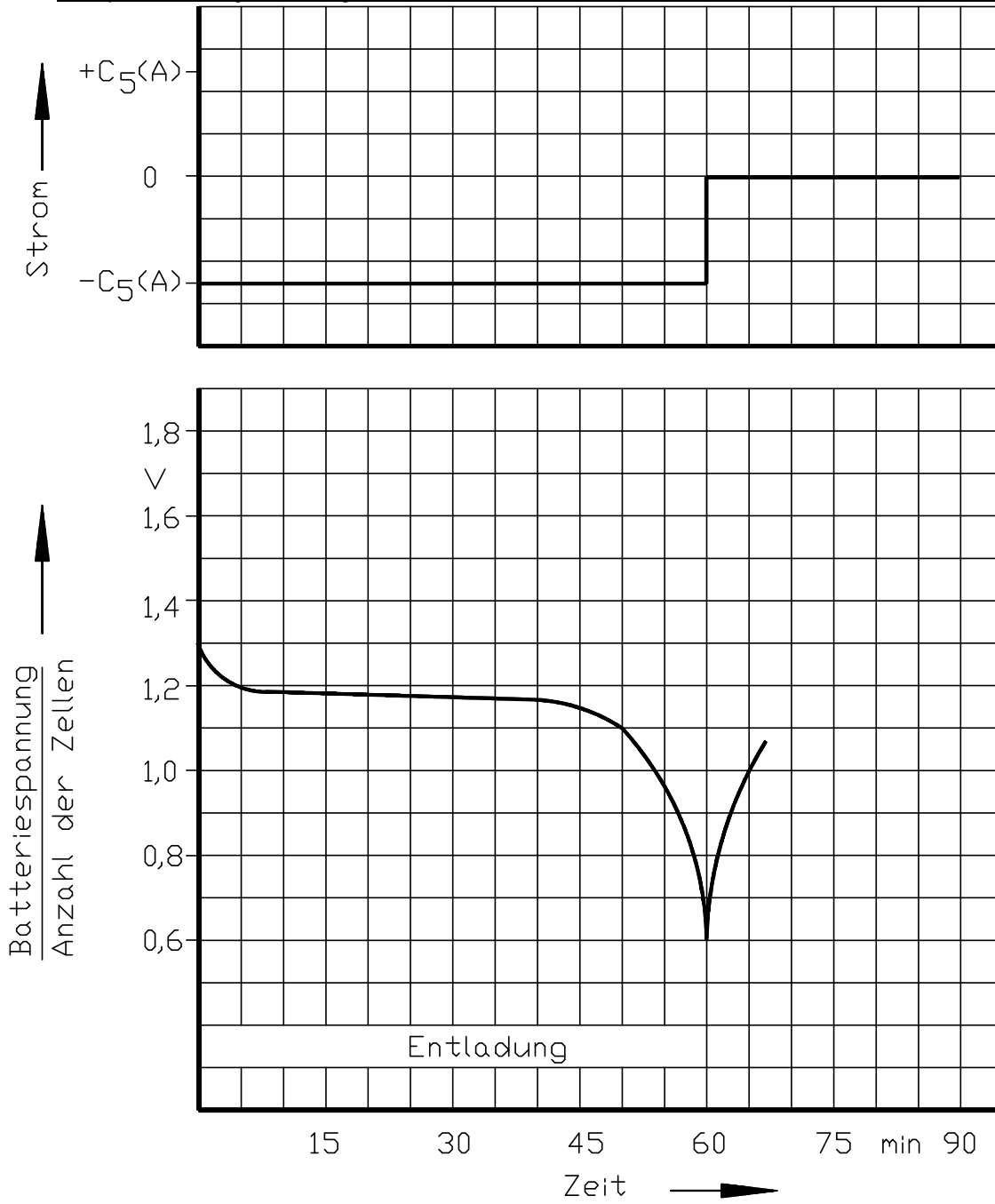

Figure 3: Program 0: Discharging of batteries with constant-current

Example of a discharging graph of a vented NiCad-battery at a load of $C_5(A)$.

2.5.2 Program 1: Analysis of vented NiCad-batteries

Program 1 is used to determine the dischargeable capacity and to rejuvenate the battery the best way.

SELECT PROGRAM (0 - 9,P,*) ? 1 **13:44:55**
P1: MAINTENANCE NICD BATTERY VENTED

2.5.2.1 Parameter inputs

Following parameters may be entered:

Amount of cells (1 - 22 cells):

P1: PARAMETER INPUT
NUMBER OF CELLS: 10 CELLS

RATED CAPACITY (2.5 - 999,9 AH in increments of 0.1Ah):

P1: PARAMETER INPUT
RATED CAPACITY: 040.0 AH

Afterwards confirm with "E" for Enter.

P2: PARAMETER INPUT
START=1 WITH PRINT=P NEW=0

The program starts according to Chapter 2.2.2 after entering "1" of "P".

If a cell scan adapter is available it is possible to scan automatically up to 23 cells by entering "P" and choice of automatic or manual cell tester.

2.5.2.2 Program steps

The program consists of the steps S1 to S6.

Step 1: S1: DISCHARGE 1

Discharging with constant-current C_5 (A) to discharging threshold-voltage 1.0 V times amount of battery-cells.

P1:S1: DISCHARGE 1
11.30V 40.00A 040.4AH +01:01 28.4°C

Step 2: S2: I-CHARGE 1

Charging with constant-current C_5 (A) to threshold-voltage 1.55 V times amount of battery-cells.

P1:S2: I-CHARGE 1
13.45V 40.00A 022.0AH +00:33 28.0°C

Step 3: S3: TOPPING CHARGE 1

90 minutes IU-charge with constant-current $0,2C_5$ (A) and a charging voltage limited to 1.55V times amount of battery-cells

P1:S3: TOPPING CHARGE 1
15.50V 02.43A 048.0AH -01:45 28.4°C

Step 4: S4: DISCHARGE 2

Discharging with constant-current C_5 (A) to discharging threshold-voltage 0.5V times amount of battery-cells.

P1:S4: DISCHARGE 2
11.30V 08.00A 040.0AH +05:00 28.4°C

Step 5: S5: I-CHARGE 2

Charging with constant-current of C_5 (A) to threshold-voltage 1.55V times amount of battery-cells.

P1:S5: I-CHARGE 2
13.45V 40.00A 022.0AH +00:33 28.4°C

Step 6: S6: TOPPING CHARGE 2

90 minutes constant-current charge with $0.2C_5$ (A).

15 minutes before topping charge 2 is finished an audible alarm reminds for cell-voltage measurement and electrolyte equalization.

To interrupt the signal it has to be acknowledged by actuating the key E = ENTER.

The measurement of single-cell-voltages is initiated by actuating the key P = PRINT. The procedure is described in the chapter "Program P".

Depending on the initial charging state of the battery this program requires a time of 6 to 8 hours.

P1:S6: TOPPING CHARGE 2
15.85V 08.00A 042.0AH -01:30 28.4°C

2.5.2.3 Monitoring functions

During program run, the following parameters of the battery (safety criteria) will be monitored:

Program steps S2, S3, S5 and S6

If the charged capacity exceeds 1.5C the program is interrupted and a fault message will be displayed.

Program steps S2, S3, S5 and S6

The temperature of the battery is monitored:

If the temperature of the battery reaches 65°C, the program is interrupted and a fault indication will be displayed.

If since start of the charging process the temperature of the battery increases by more than 20°C and in between exceeds 30°C the program stops and a fault message is displayed.

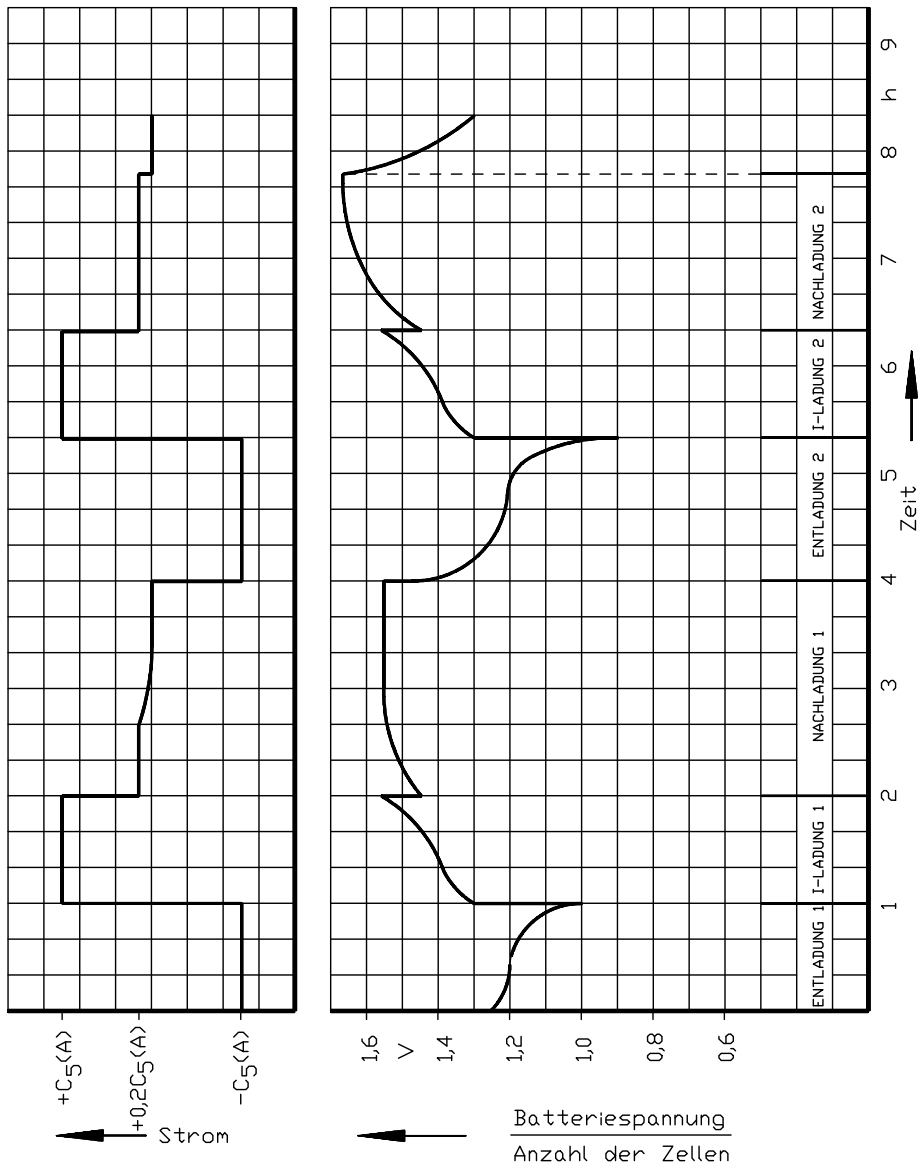

Figure 4: Program 1: Analyses of vented NiCad-batteries

Example of the voltage and current graph of a battery, which was partially charged at the beginning of the maintenance cycle

2.5.3 Program 2: Charging of vented NiCad-batteries

Program 2 is used for NiCad-Cells and -Batteries with sinter-electrodes.

The program is used for shortest time full charging of batteries with any initial charging state

SELECT PROGRAM (0 - 9,P,*) ? 2 **23:44:55**
P2: CHARGE NICD BATTERY VENTED

2.5.3.1 Parameter inputs

Following parameters may be entered:

Amount of cells (1 - 22 cells)

P2: PARAMETER INPUT
NUMBER OF CELLS: 10 CELLS

RATED CAPACITY (2.5 – 999.9 AH in increments of 0.1Ah):

P2: PARAMETER INPUT
RATED CAPACITY: 040.0AH

Afterwards confirm with "E" for Enter.

P2: PARAMETER INPUT
START=1 WITH PRINT=P NEW=0

The program starts according to Chapter 2.2.2 after entering "1" of "P".

If a cell scan adapter is available it is possible to scan automatically up to 23 cells by entering "P" and choice of automatic or manual cell tester.

2.5.3.2 Program steps

The program consists of the steps S1 and S2.

Step S1: I-CHARGE

Charging with constant-current C_5 (A) to threshold-voltage 1.55 V times amount of battery-cells.

For information about printout please refer to chapter 2.1.1.2

P2:S1: I-CHARGE 1
13.30V 40.00A 06.66AH +00:10 28.4°C

Step S2: TOPPING CHARGE

90 minutes constant-current charge with 0.2 C_5 (A).

15 minutes before topping charge 2 is finished an audible alarm reminds for cell-voltage measurement and electrolyte equalization.

To interrupt the signal it has to be acknowledged by actuating the key E = ENTER.

The measurement of single-cell-voltages is initiated by actuating the key P = PRINT. The procedure is described in the chapter "Program P".

End of program is indicated by a short audible alarm.

Depending on the initial charging state of the battery this program requires a time of 90 to 150 minutes.

P2:S2: TOPPING CHARGE
15.88V 08.00A 044.0AH -00:15 38.4°C

2.5.3.3 Monitoring functions

During program run, the following parameters of the battery (safety criteria) will be monitored:

Steps S1 and S2

The charged capacity must not exceed $1.5C_5$

Steps S1 and S2

If the temperature of the battery reaches 65°C, the program is interrupted and a fault indication will be displayed.

If since start of the charging process the temperature of the battery increases by more than 20°C and in between exceeds 30°C the program stops and a fault message (chapter 3.3) is displayed.

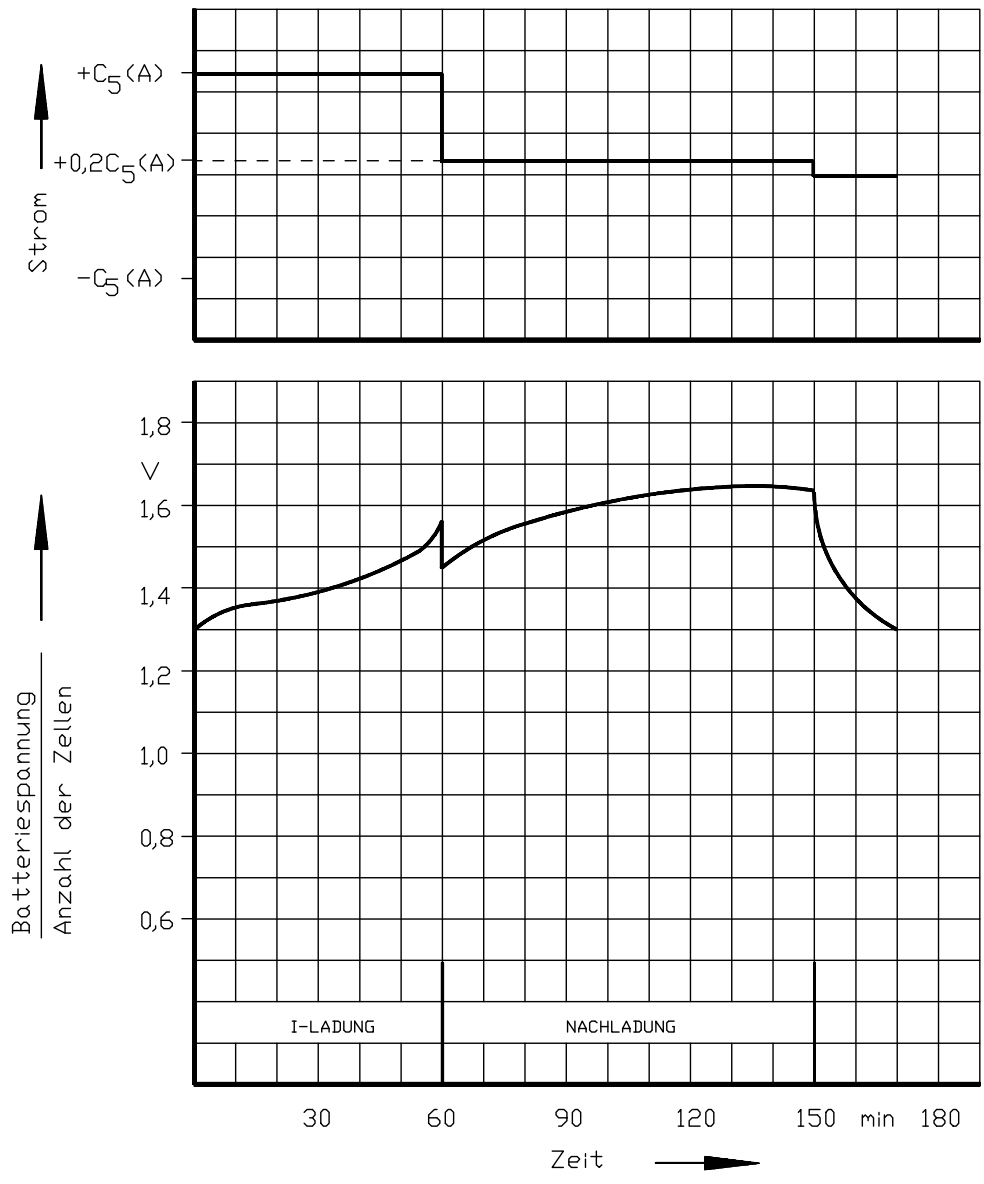

Figure 5: Program 2: Charging of vented NiCad-batteries

Example of the voltage and current graph of a vented NiCad-battery

2.5.4 Program 3: Test-cycle for sealed lead-acid-batteries

The program 3 is valid for sealed lead-acid-batteries with fixed electrolytes. It is used to determine the residual capacity, to rejuvenate the battery and to increase it to the best level.

SELECT PROGRAM (0 - 9,P) ? 3
P3: MAINTENANCE PB BATTERY

2.5.4.1 Parameter inputs

The following program parameters are individually selectable:

- Rated voltage from 2 to 24V by steps of 2V
- Rated capacity from 2.5 to 1000Ah by steps of 0.1Ah

Selecting the program 3 by actuating the **E-ENTER-key** indicates the following display:

P3: PARAMETER INPUT
VOLTAGE ? 00.00V

PARAMETER INPUT and actuating the **ENTER-Key**:

P3: PARAMETER INPUT
CAPACITY ? 0.000AH

PARAMETER INPUT and actuating the **E-ENTER-key**:

P3: PARAMETER INPUT
START =1 WITH PRINT=P NEW=0

Entering of 1 or P actuates the program start as described in chapter 2.2.2.

2.5.4.2 Program steps

The program 3 consists of 2 program steps S1 to S7.

Step S1: DISCHARGE 1

Constant discharging with a current of $0.2 C_5$ (A) up to a voltage of 1,5V/cell (series connected battery-cells).

NOTE

The DISCHARGING 1 is not applicable by deep discharged batteries.

P3: S1: DISCHARGING 1
13.30V 40.00A 000.0AH +00:00H 28.4°C

Step S2: PRECHARGE

Constant charging up to a voltage of 2,4V/cell (series connected battery-cells) with a current of $0.4 C_5$ (A). The duration of program-step S2 is limited to a maximum of 15 hours.

NOTE

The PRECHARGE is not applicable by deep discharged batteries.

P3: S2: PRECHARGE
14.40V 02.34A 000.0AH -15:00H 22.4°C

Step S3: I-CHARGE 1

Constant charging with a current of $0.4 C_5$ (A) up to a battery voltage of 2.4V/cell (series connected battery-cells). The duration of program-step S3 is limited to a maximum of 6 hours.

P3: S3: I-CHARGE 1
13.20V 40.00A 000.0AH -06:00H 22.6°C

Step S4: U-CHARGE 1

Constant charging with voltage of 2.4V/cell (series connected battery-cells) down to the cut of current of $0.04C_5$ (A). The duration of program-step S4 is limited to a maximum of 6 hours.

P3: S4: U-CHARGE 1
14.40V 39.84A 079.1AH -04:01H 28.4°C

Step S5: DISCHARGE 2

Constant discharging with a current of $0.2 C_5$ (A) up to a voltage of 1,5V/cell (series connected battery-cells).

P3: S5: DISCHARGE 2
12.80V 08.00A 000.0AH +00:00H 24.3°C

Step S6: I-CHARGE 2

Constant charging with a current of $0.4 C_5$ (A) up to a battery voltage of 2.4V/cell (series connected battery-cells). The duration of program-step S6 is limited to a maximum of 6 hours.

P3: S6: I-CHARGE 2
13.50V 40.00A 000.0AH -06:00H 28.4°C

Step S7: U-CHARGE 2

Constant charging with voltage of 2.4V/cell (series connected battery-cells) down to the cut of current of $0,04C_5$ (A). The duration of program-step S7 is limited to a maximum of 6 hours.

P3: S7: U-CHARGE 2
14.40V 39.64A 080.0AH -04:00H 32.4°C

Depending on the initial charging conditions of the connected battery the program requires a time of 17 to 22 hours, for deep-discharged battery up to 32 hours.

2.5.4.3 Supervisory functions

During the program-run the connected battery is supervised due to the following parameters.

Step S2

The charging current must reach a minimum value of $0,4 C_5$ (A) within a time-period of 15 hours. If the charging current is not accessible, the program will be interrupted by a fault message and the battery is identified as faulty.

Steps S3 and S4

The in loaded capacity have to reach at last the capacity of C_5 if the precharge have taken more than 3 minutes to reach the charging current of $0,4 C_5$. If the charging current is not accessible, the program will be interrupted by a fault message and the battery is identified as faulty.

Steps S2, S3 and S4

If the in loaded capacity exceeds a value of $2 C_5$ (A), the program will be interrupted by a fault message and the battery is identified as faulty.

Steps S3, S4, S6 and S7

The charging current must exceeds up to a maximum value of $0,04 C_5$ (A) during the U-CHARGE, otherwise the program will be interrupted by a fault message and the battery is identified as faulty.

Steps S6 and S7

The in loaded capacity to reach at last the capacity of C_5 (A), otherwise the program will be interrupted by a fault message and the battery is identified as faulty.

Steps S6 and S7

The in loaded capacity is limited to a maximum of $1,5 C_5$. Exceeding the indicated capacity the program is interrupted and the battery is identified as faulty.

Steps S2, S3, S4, S6 and S7

If the battery temperature exceeds 65°C , or if the temperature increase 20°C since the beginning of charging und exceeds 30°C , the program will be interrupted by a fault message described in chapter 3.3.

The temperature monitoring starts with step S5: I-CHARGE 2 again. This ensures that the increase of the battery during the previous discharging will be disregarded.

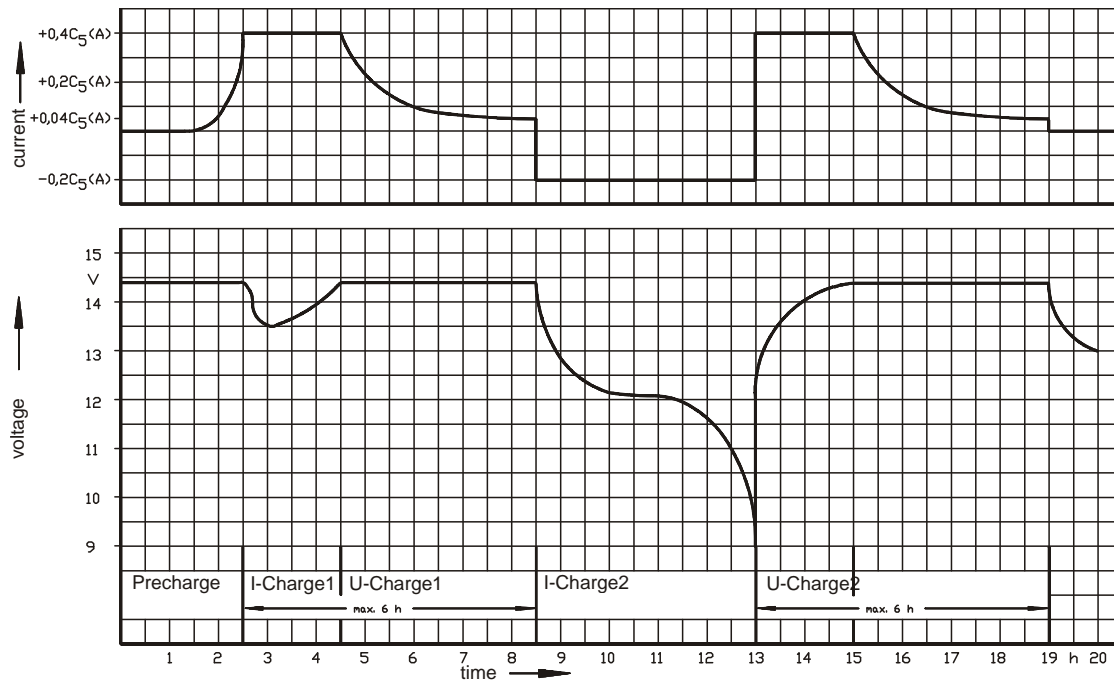

Figure 6: Program 3: Test cycle for sealed lead-acid batteries

Example for the voltage- and current-graph of an initially deep-discharged sealed lead-acid-battery.

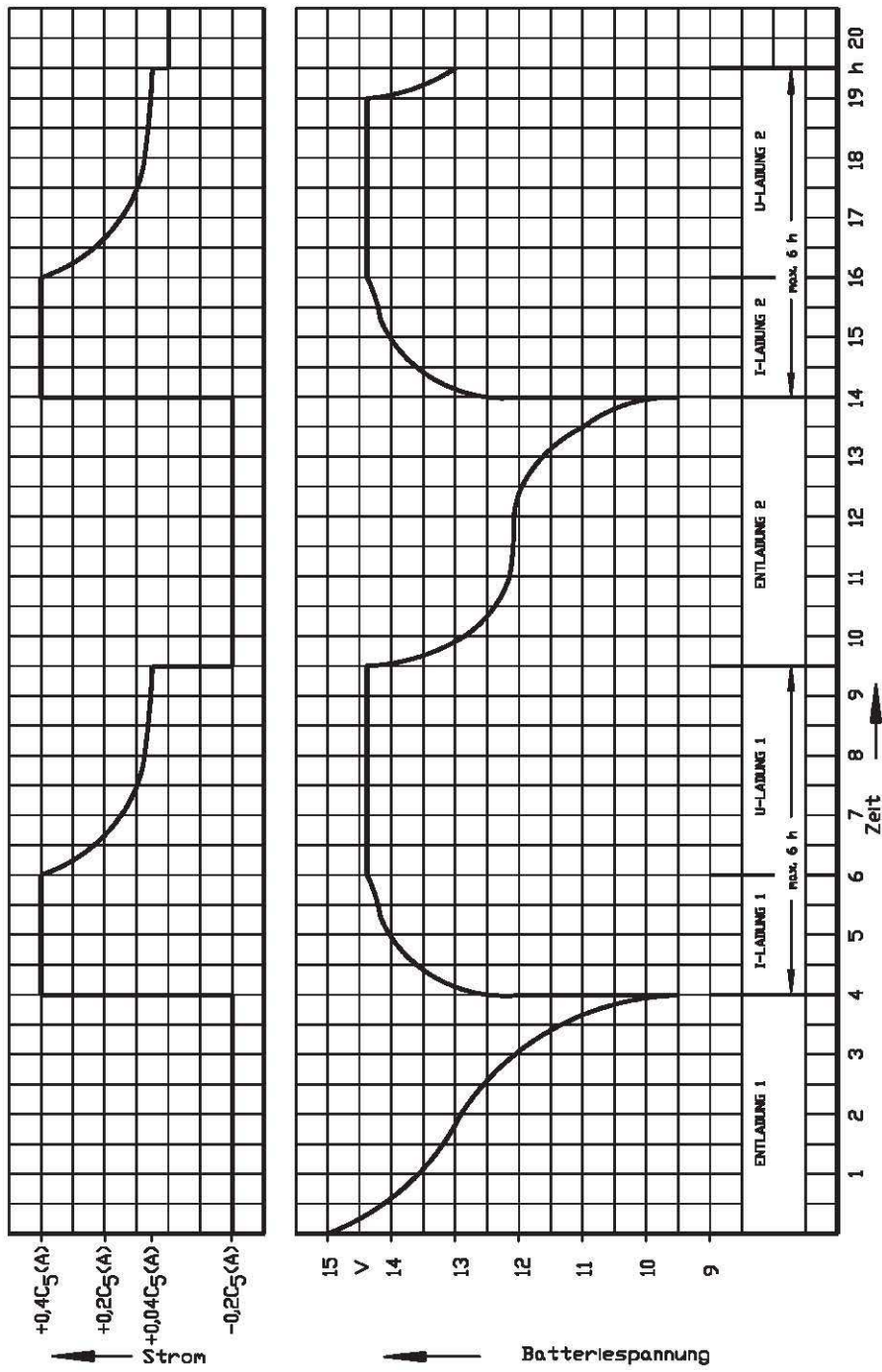

Figure 7: Program 3: Test cycle for sealed lead-acid batteries

Example for the voltage- and current-graph of an initially deep-discharged sealed lead-acid-battery.

2.5.5 Program 4: Charging of sealed lead-acid-batteries

The program 4 is valid for sealed lead-acid-batteries with fixed electrolyte

SELECT PROGRAM (0 - 9,P) ? 4
P4: CHARGE PB BATTERY

2.5.5.1 Parameter inputs

The following program parameters are individually selectable:

- Rated voltage from 2 to 24V by steps of 2V
- Rated capacity C_5 from 2.5 to 1000Ah by steps of 0.1Ah

Selecting the program 4 by actuating the **E-ENTER-Key** indicates the following display:

P4: PARAMETER INPUT
VOLTAGE ? 00.00V

PARAMETER INPUT and actuating the **E-ENTER-key**:

P4: PARAMETER INPUT
CAPACITY ? 000.0AH

PARAMETER INPUT and actuating the **E-ENTER-key**:

P4: PARAMETER INPUT
START = 1 WITH PRINT=P NEW=0

Entering of 1 or P actuates the program start as described in chapter 2.2.2.

2.5.5.2 Program steps

The program 4 consists of 1 program step S1 to S3.

Step S1: PRECHARGE

Charging with constant-current with 2.4V/cell (series connected battery-cells), up to a charging current of 0.4 C_5 (A).

P4: S1: PRECHARGE
14.40V 01.23A 000.0AH +00:00H 28.4°C

The Precharge is not applicable by halfway loaded batteries.

Step S2: I-CHARGE

Charging with constant-current of 0.4 C_5 (A) up to a battery-voltage of 2.4V times amount of the series connected battery-cells. The duration of program-step S2 is limited to a maximum of 6 hours.

P4: S2: I-CHARGE
13.30V 40.00A 000.0AH -06:00H 28.4°C

Step S3: U-CHARGE

Charging with constant-voltage by 2.4V/cell (series connected cells), till the charging current dropped to 0.04 C_5 (A). The duration of program-step S3 is limited to a maximum of 6 hours.

Depending on the basic charging conditions of the connected battery, the program requires a time of 1 and 6 hours, for deep discharged batteries up to 21 hours.

P4: S3: U-CHARGE
14.40V 39.84A 080.0AH -04:00H 28.6°C

2.5.5.3 Supervisory functions

During the program-run the connected battery is supervised due to the following parameters.

Step S1

The charging current must reach a minimum value of $0,4 C_5$ (A) within a time-period of 15 hours. If the charging current is not accessible, the program will be interrupted by a fault message and the battery is identified as faulty.

Steps S2 and S3

The in loaded capacity have to reach at last the capacity of C_5 if the precharge have taken more than 3 minutes to reach the charging current of $0,4 C_5$. If the charging current is not accessible, the program will be interrupted by a fault message and the battery is identified as faulty.

Steps S1, S2 and S3

If the in loaded capacity exceeds a value of $2 C_5$ (A), the program will be interrupted by a fault message and the battery is identified as faulty.

Steps S2 and S3

The charging current must exceeds up to a maximum value of $0,04 C_5$ (A) during the U-CHARGE, otherwise the program will be interrupted by a fault message and the battery is identified as faulty.

Steps S1, S2 and S3

If the battery temperature exceeds 65°C , or if the temperature increase 20°C since the beginning of charging und exceeds 30°C , the program will be interrupted by a fault message described in chapter 3.3.

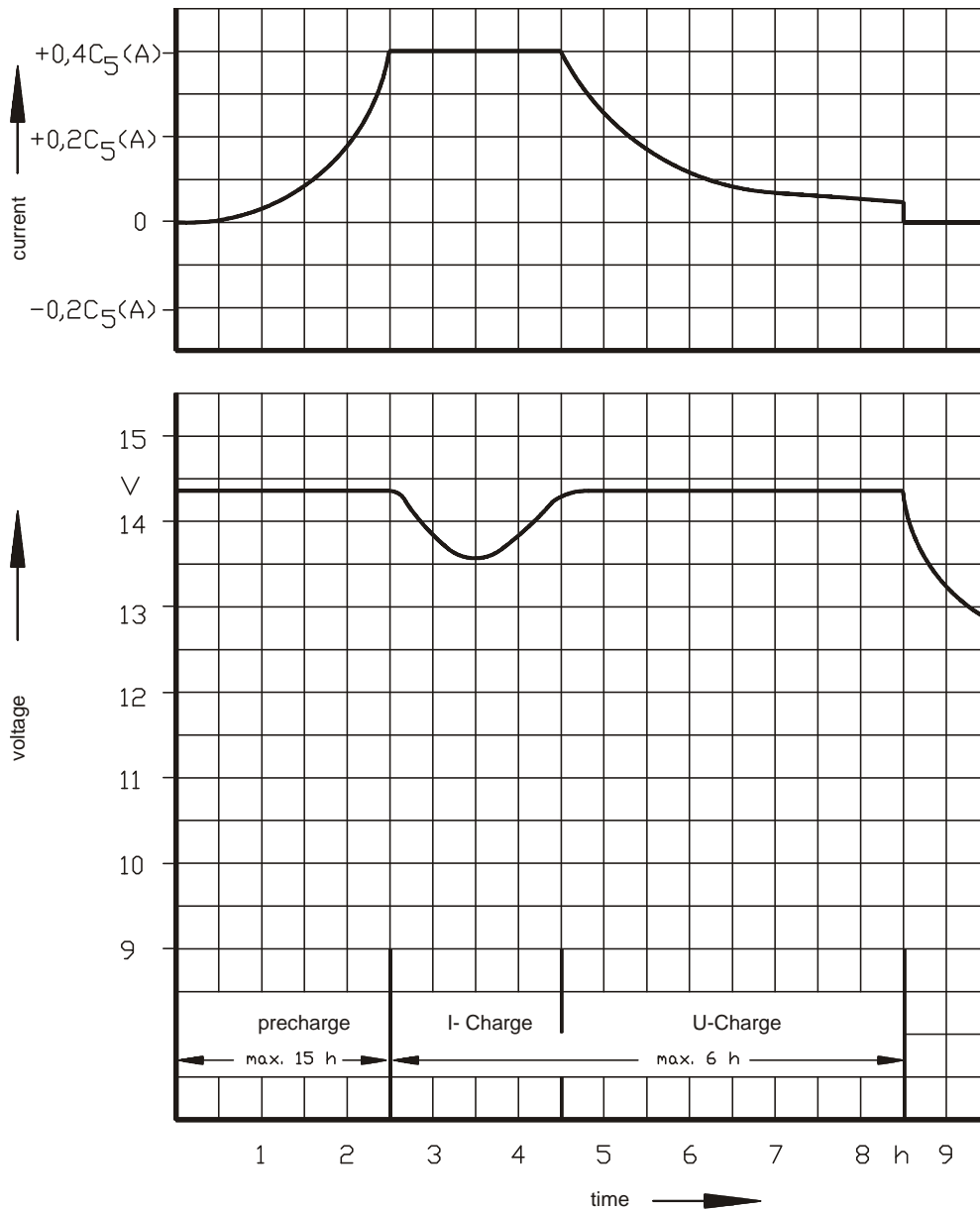

Figure 8: Program 4: Charge of sealed lead-acid batteries

Example for the voltage- and current-graph of an initially deep-discharged lead-acid-battery.

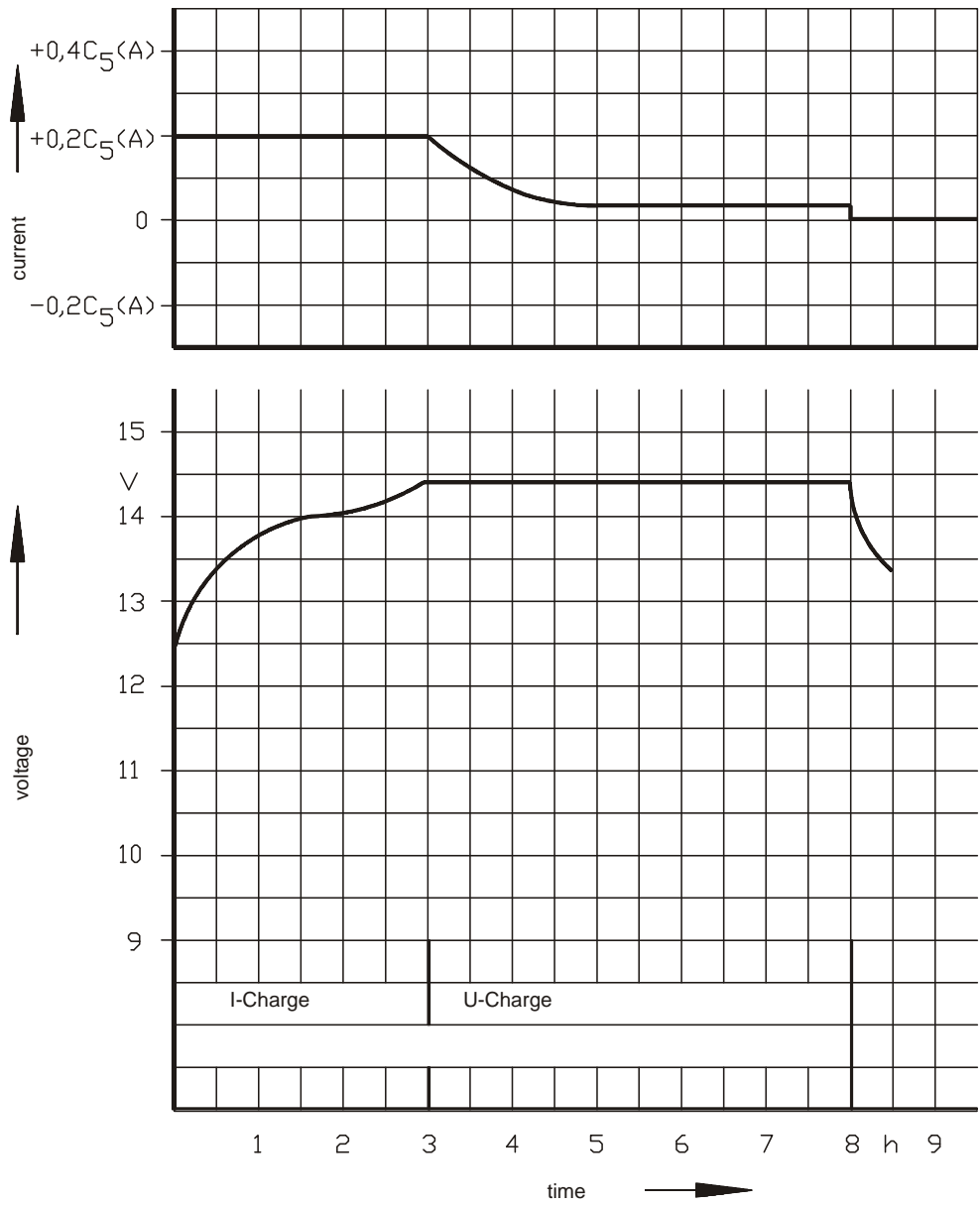

Figure 9: Program 4: Charge of sealed lead-acid-batteries

Example for the voltage- and current-graph of an initially partial charged sealed lead-acid-battery.

2.5.6 Program 5: Charging of sealed NiCad-batteries

The program 5 is used for sealed NiCad batteries.

SELCT PROGRAM (0-9,P,*) ? 5
P5: CHARGE NICD BATTERY SEALED

2.5.6.1 Parameter inputs

Following parameter may be selected:

Rated voltage from 1.2V to 31.2V in 1.2V increments

P5: PARAMETER INPUT
RATED VOLTAGE: 31.2V

Rated capacity C₅ (0.5 - 40Ah)

PARAMETER INPUT
RATED CAPACITY 40.0AH

2.5.6.2 Program steps

The program consists of the program steps S1 and S2.

Step S1: DISCHARGE

Discharging with constant current C₅ (A) to discharging threshold voltage 1.0V times amount of battery-cells.

P5: S1: DISCHARGE
12.30V 04.00A 002.2AH +00:33 38.4°C

Step S2: I-CHARGE

75 minutes constant-current charge with C₅ (A).

End of program is indicated by a short audible alarm.

Depending on the initial charging state of the battery this program requires a time of 75 to 135 minutes.

P5: S2: I-CHARGE
15.10V 04.00A 004.4AH -01:06 32.1°C

2.5.6.3 Monitoring functions

During program run, the following parameters of the battery (safety criteria) will be monitored:

Step S2:

If the charged capacity does not reach the value C_5 or exceeds the value $1,5 C_5$, the program is interrupted and a fault message will be displayed.

Step S2:

If since begin of the charging period the temperature of the battery increases by more than 20°C and in between exceeds 30°C the program is interrupted and a fault message (chapter 3.3) is displayed.

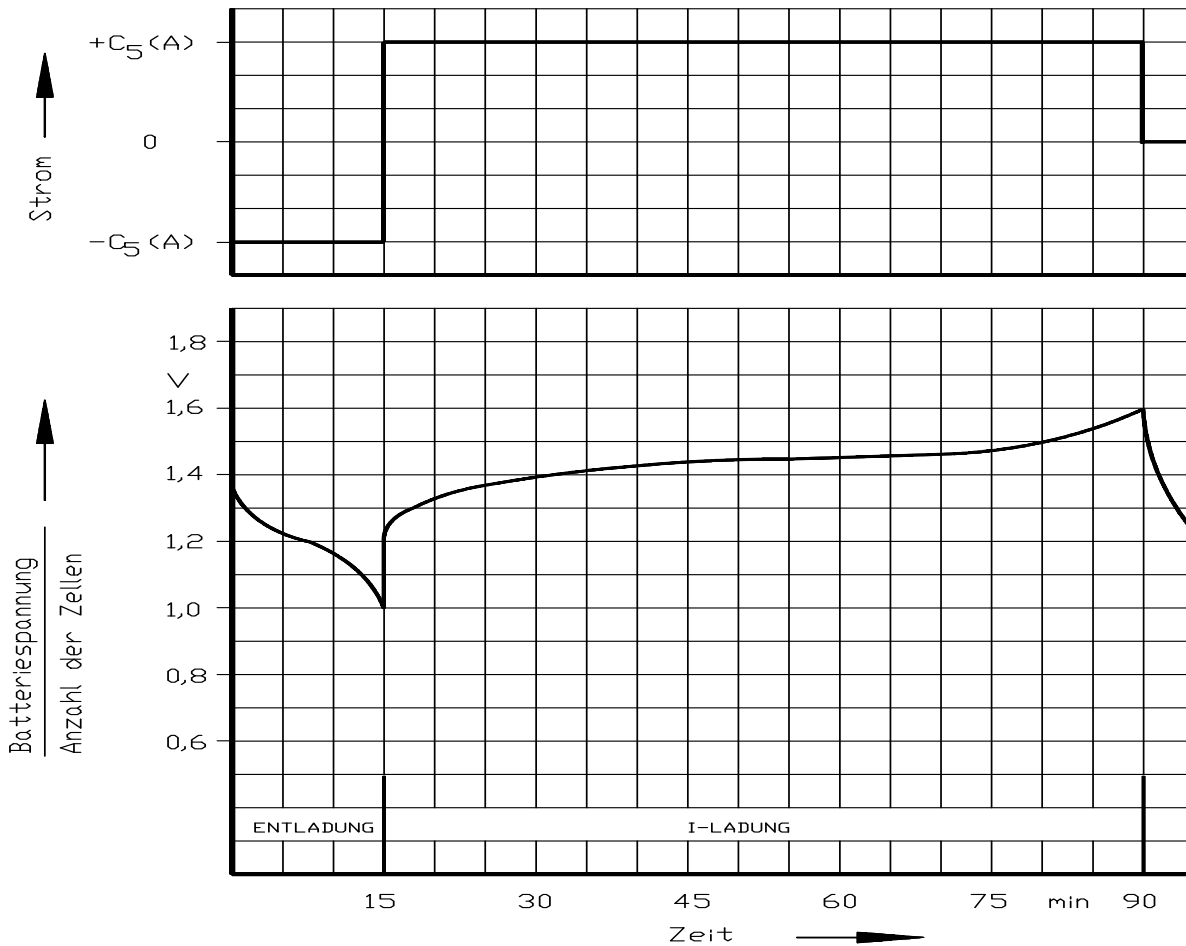

Picture 10: Program 5: Charging of sealed NiCad-batteries

Example of the voltage and current graph of an initially partially charged sealed NiCad-battery

2.5.7 Program 6: Constant-current (I)-charging, time limited

SELECT PROGRAM (0 - 9,P,*) ? 6 23:44:55
P6: I-CHARGE TIME LIMITED

2.5.7.1 Parameter inputs

Following program parameter may be selected:

Charging current (A)

P6: PARAMETER INPUT
CURRENT ? 00.70 A

Charging time (min)

P6: PARAMETER INPUT
CHARGING TIME ? 14:00 h/min

2.5.7.2 Program steps

Program 6 only consists of step S1.

Step S1: I-CHARGE

Charging with selected constant-current for a selected duration.

End of program is indicated by a short audible alarm.

P6: S1: I-CHARGE
13.30V 00.70A 000.4AH -13:30 25.4°C

2.5.7.3 Monitoring functions

During program run, the following parameters of the battery (safety criteria) will be monitored:

Step S1

If the charged capacity exceeds $1.5C_5$ the program is interrupted and a fault message will be displayed.

If the battery voltage drops by more than 20mV/cell after achieving a peak value, the program is interrupted and a fault message is displayed.

If the temperature of battery exceeds 65°C the program is interrupted and a fault message will be displayed.

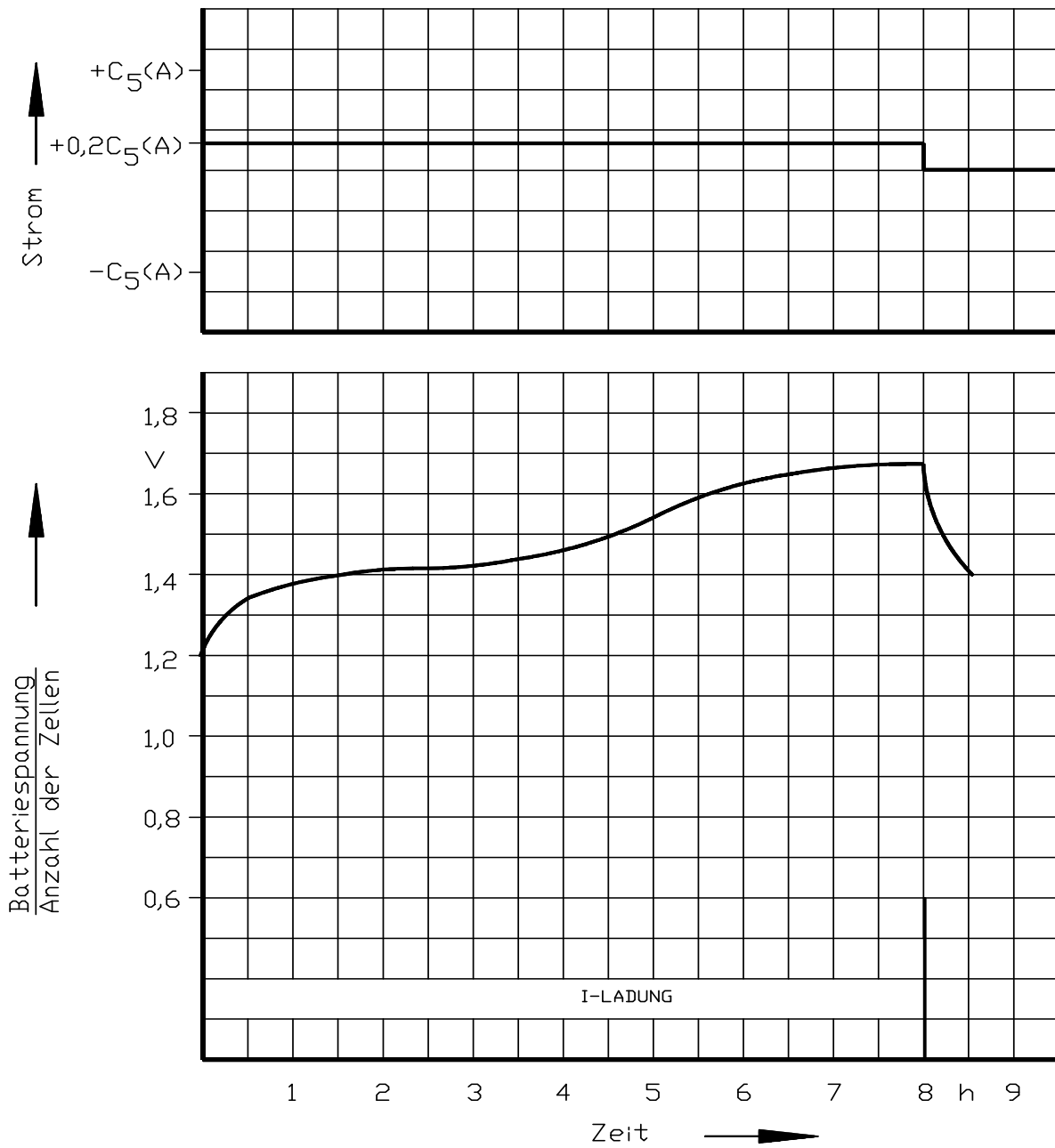

Picture 11: Program 6: Constant-current (I)-charge, time limited

Example of the voltage and current graph of an initially discharged vented NiCad-battery charged with $0.2 C_5$ (A)

2.5.8 Program 7: Constant-current - constant-potential (IU)-charge, time limited / non time limited

Program 7 may be used with or without time limitation.

SELECT PROGRAM (0 - 9,P,*) ? 7 13:34:50
P7: IU-CHARGE TIME/NOT TIME LIMITED

2.5.8.1 Time-limited IU-Charge

2.5.8.1.1 Parameter inputs

Following program parameter may be selected:

Rated voltage (V)

P7: PARAMETER INPUT
RATED VOLTAGE: 12.00 V

Capacity (Ah)

P7: PARAMETER INPUT
CAPACITY: 36.00 AH

Charging current (A)

P7: PARAMETER INPUT
CURRENT: 20.00 A

Charging voltage (V)

P7: PARAMETER INPUT
VOLTAGE: 14.4 V

Charging time (MIN)

P7: PARAMETER INPUT
CHARGING TIME: 04:00 h/min

2.5.8.1.2 Program steps

The time-limited IU-charge consists of steps S1 und S2

Step S1: I-CHARGE

Constant-current-charge with a selected current until a selected battery voltage U is achieved.

P7: S1: I-CHARGE
13.70V 20.00A 010.0AH -00:30 30.4°C

Step S2: U-CHARGE

Constant-potential-charge with preselected battery voltage U until a selected total charging time T is elapsed.

P7: S2: U-CHARGE
14.40V 03.55A 022.0AH -00:30 31.4°C

2.5.8.1.3 Monitoring functions

During program run, the following parameters of the battery (safety criteria) will be monitored:

Steps S1 and S2

If the charged capacity exceeds $1.5C_5$ the program is interrupted and a fault message will be displayed.

Steps S1 and S2:

If the temperature of the battery reaches 65°C , the program is interrupted and a fault indication will be displayed.

If since begin of the charging period the temperature of the battery increases by more than 20°C and in between exceeds 30°C the program is interrupted and a fault message (chapter 3.3) is displayed.

2.5.8.2 Non-Time-Limited IU-Charge

The non-time-limited IU-Charge is performed by just entering 0 minutes for the charging time.

The printout cycle for the protocol may be preselected between 10 minutes and 99:59 hours.

After exceeding a charging time of 99:59 hours the charging time indication starts again with 00:00.

The capacity indication also starts again with 0.000 after exceeding a charged capacity of 999.9Ah.

2.5.8.2.1 Parameter inputs

Following program parameter may be selected:

Rated voltage (V)

**P7: PARAMETER INPUT
RATED VOLTAGE: 12.00 V**

Capacity (Ah)

**P7: PARAMETER INPUT
CAPACITY: 36.00 AH**

Charging current (A)

**P7: PARAMETER INPUT
CURRENT: 12.00 A**

Constant potential (V)

**P7: PARAMETER INPUT
VOLTAGE: 14.40 V**

Charging time (0 Minutes)

**P7: PARAMETER INPUT
TIME: 00:00 h/min**

The printout cycle for the protocol may be preselected between 10 minutes and 99:59 hours.

**P7: PARAMETER INPUT
PRINT TIME CYCLE: 01:00 h/min**

2.5.8.2.2 Program steps

The non-time-limited IU-charge consists of steps S1 und S2.

Step S1: I-CHARGE

Constant-current-charge with a selected current I, until a selected battery voltage U is achieved.

P7:S1: I-CHARGE				
12.30V	20.00A	010.0AH	+00:30	18.4°C

Step S2: U-CHARGE

Constant-potential-charge with the preselected battery voltage U as long as the program is active.

The limitation of the charging current is set by the entered charging current.

P7:S2: U-CHARGE				
14.40V	00.03A	048.0AH	+99:59	18.2°C

2.5.8.2.3 Monitoring functions

Steps S1 and S2

If the temperature of one battery terminal reaches $(65 \pm 2) ^\circ\text{C}$, the program is interrupted and a fault indication will be displayed.

If since begin of the charging period the temperature of the battery increases by more than 20°C and i_n between exceeds 30°C the program is interrupted and a fault message (chapter 3.3) is displayed.

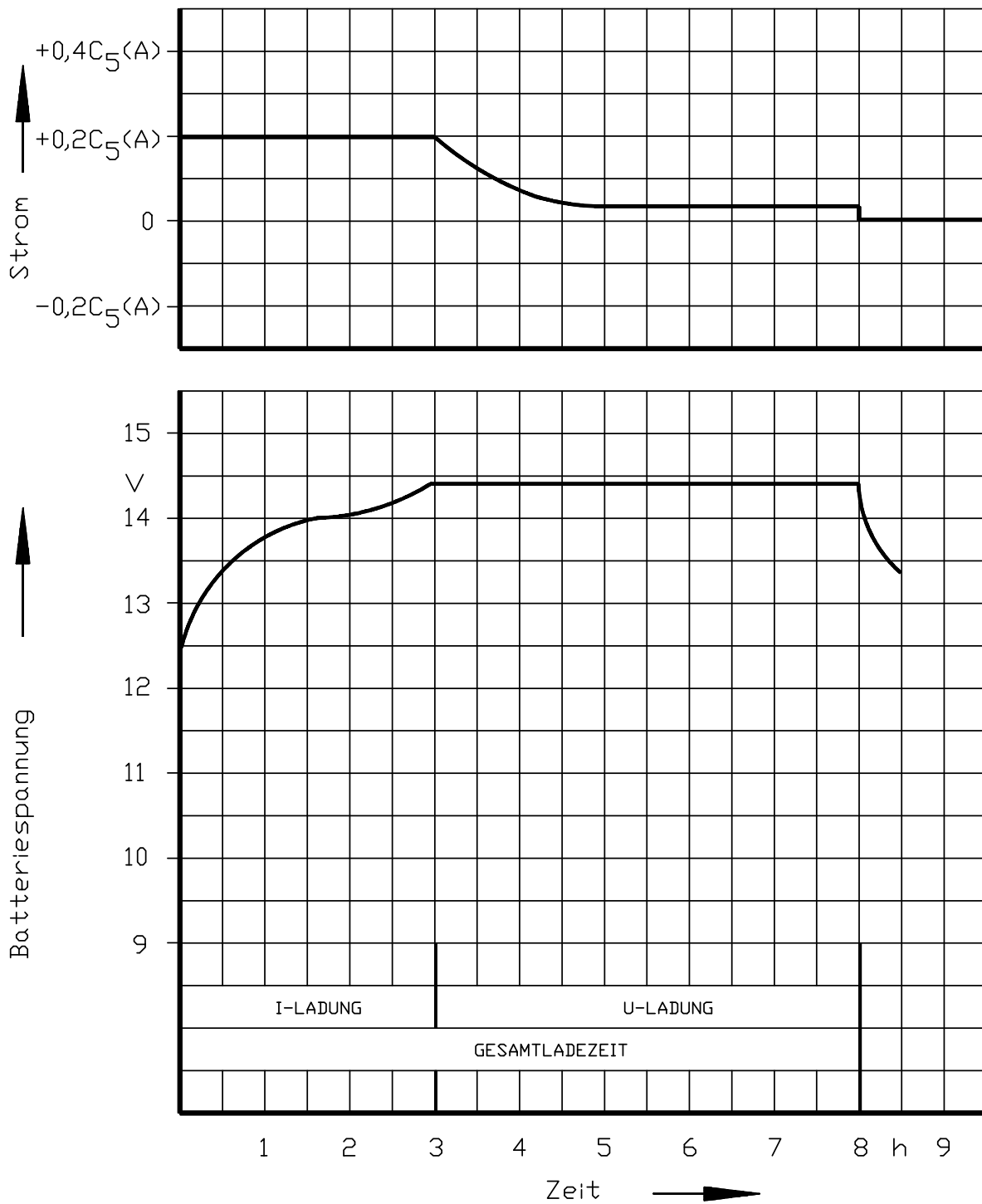

Figure 12: Program7: Constant-current - Constant-potential (IU)-charge, time-limited

Example of the voltage and current graph of a sealed lead-acid-battery

2.5.9 Program 8: Maintenance of NiCad-Batteries Code C (1000Ah)

Program 3 is used for sealed NiCad-Aeronautic-Batteries with sinter electrodes.

The program is used to determine the residual capacity and rejuvenates the battery the best way

SELECT PROGRAM (0 - 9,P,*) ? 3 23:44:55
P8: ANALYSIS OF NI/CD-BATTERIES CODE C

2.5.9.1 Parameter input

Following parameters have to be entered:

Number of cells (1 - 20 cells)

P8: PARAMETER INPUT ?
NUMBER OF CELLS 20 CELLS

Rated Capacity (0.5 to 99.9 Ah in 0.1 Ah-Steps)

P8: PARAMETER INPUT ?
RATED CAPACITY 23.00 AH

Discharge current

P8: PARAMETER INPUT ?
DISCHARGE 20.00 A

Cut Off Voltage Deep-Discharge (0.01 - 1.00 V/Cell)

P8: PARAMETER INPUT ?
CUT OFF VOLTAGE DEEP-DISCHARGE 0.10 V/C

Cut Off Voltage (0.01 - 1.00 V/Cell)

P8: PARAMETER INPUT ?
CUT OFF VOLTAGE 1.00 V/C

Min. Capacity (0.5 to 99.9 Ah)

P8: PARAMETER INPUT ?
MIN. CAPACITY 23.00 AH

Deep Cycle Time (00:00 - 16:00 H)

P8: PARAMETER INPUT ?
DEEP CYCLE TIME 08:00 H

I-Charge 1 (0.5 - 40.00 A)

P8: PARAMETER INPUT ?
I-CHARGE 1 12.50 A

Begin of Toppingcharge (0.01 - 2.00 V/C)

P8: PARAMETER INPUT ?
BEGIN OF TOPPINGCHARGE 1.55 V/C

I-Toppingcharge (0.5 - 40.00 A)

P8: PARAMETER INPUT ?
I-TOPPINGCHARGE 2.3 A

Toppingcharge Time (00:00 - 24:00 H)

P8: PARAMETER INPUT ?
TOPPINGCHARGE TIME 04:00 H

Max. Endpoint Voltage per Cell (0.01 - 2.00 V/C)

P8: PARAMETER INPUT ?
MAX. CELL ENDPOINTVOLTAGE 1.80 V/C

Min. Endpoint Voltage per Cell (0.01 - 2.00 V/C)

P8: PARAMETER INPUT ?
MIN. CELL ENDPOINTVOLTAGE 1.50 V/C

Max. Capacity (000 - 999 %) or max charging Time

P8: PARAMETER INPUT ?
MAX. CAPACITY 140 %
MAX. CHARGING TIME 16 H

Wait (00:00 - 16:00 H)

P8: PARAMETER INPUT ?
WAIT 01:00 H

Program Start

P8: PARAMETER INPUT ?
START WITH PRINT = P

2.5.9.2 Program steps

The program consists of the steps S1 to S9.

Step S1: DISCHARGE 1 (Rest-discharge)

Discharging with constant-current C_5 (A) to discharging threshold-voltage of ≤ 1.0 V / cell times amount of serially connected battery-cells.

P8: S1: RESTDISCHARGE
22.26V 4.60A 00.26AH +00:30 H --°C

Protocol see Chapter 2.5.11

Step S2: DEEP-DISCHARGE

Deep-discharge with constant-current C (A) V to discharging threshold-voltage of ≤ 1.0 V (U_{Bat}), as long as $U_{\text{Bat}} > 1$ V.

P8: S2: DEEP-DISCHARGE
19.00V --.--A 00.34 AH +21:69 H --°C

Step S3: Deep-discharge (Zero-Discharge)

Deep-discharge with constant-current C (A) V for determined Deep-Cycle-Time T, if $U_{\text{Bat}} < 1$ V.

P8: S3: DEEP-DISCHARGE
01.00V --.-- A 01.64 AH +22:00 H --°C

Protocol see Chapter 2.5.11

Step S4: I-CHARGE 1

Charging with constant-current (A) to the determined battery voltage (max. endpoint voltage), considering max. charging time determined and min. capacity.

P8: S4: I-CHARGE 1
28.84 V 23.00 A 00.34 AH +07:00 H --°C

Step S4: Check of electrolyte level

The electrolyte level has to be checked if max endpoint voltage is not achieved.

P8: S4: CHECK ELEKTROLYTE
28.84 V --.-- A 15.58 AH +05:00 H --°C

Step S5: Begin of Topping Charge

IU-Charge with determined current (A) considering max charging time and capacity.

P8: S4: BEGIN OF TOPPING CHARGE
28.84 V 02.30 A 15.58 AH +06:00 H --°C

Step S5: Topping Charge 1

Repetition of steps S4: I-Charge; in case of need check electrolyte level; parameters considered: charging time, capacity, residual charging time and max/min endpoint voltages.

P8: S5: TOPPING CHARGE 1

32.14 V 02.30 A 26.58 AH -03:30 H -.-°C

Protocol see Chapter 2.5.11

Step S6: Capacity Check

Discharge with determined constant-current to determined Cut-off voltage considering min. dischargeable capacity.

P8: S6: CAPACITY CHECK

23.14 V 40.30 A 00.53 AH -01:30 H -.-°C

Printout: "Battery Defect" or Cell voltages

Step S7: Wait state

Programmed pause according to determined "wait" parameters before performing the final maintenance steps.

P8: S7: WAIT

23.14 V --.-- A 00.53 AH -01:30 H -.-°C

Step S8: I-Charge 2

Charging with determined constant-current (A) as described for step 4.

P8:S7: I-CHARGE 2

28.14 V 40.0 A 18.23 AH +16:00 H -.-°C

Step S9: Topping-Charge 2

Charging with determined constant-current (A) as described for step 5.

P8:S7: I-CHARGE 2

32.14 V 02.30 A 26.00 AH -04:00 H -.-°C

Printout: Cell voltages; Program finished: "**Battery OK**"

2.5.9.3 Monitoring functions

Program steps S4, S5, S8 and S9

If the charged capacity exceeds 1,5 C the program is aborted and a fault message will be displayed.

Program steps S2, S3, S5 and S6

The temperature of the battery is monitored (if applicable):

If the temperature of the battery reaches 65°C, the program is interrupted and a fault indication will be displayed.

If since start of the charging process the temperature of the battery increases by more than 20°C and in between exceeds 30°C the program stops and a fault message is displayed.

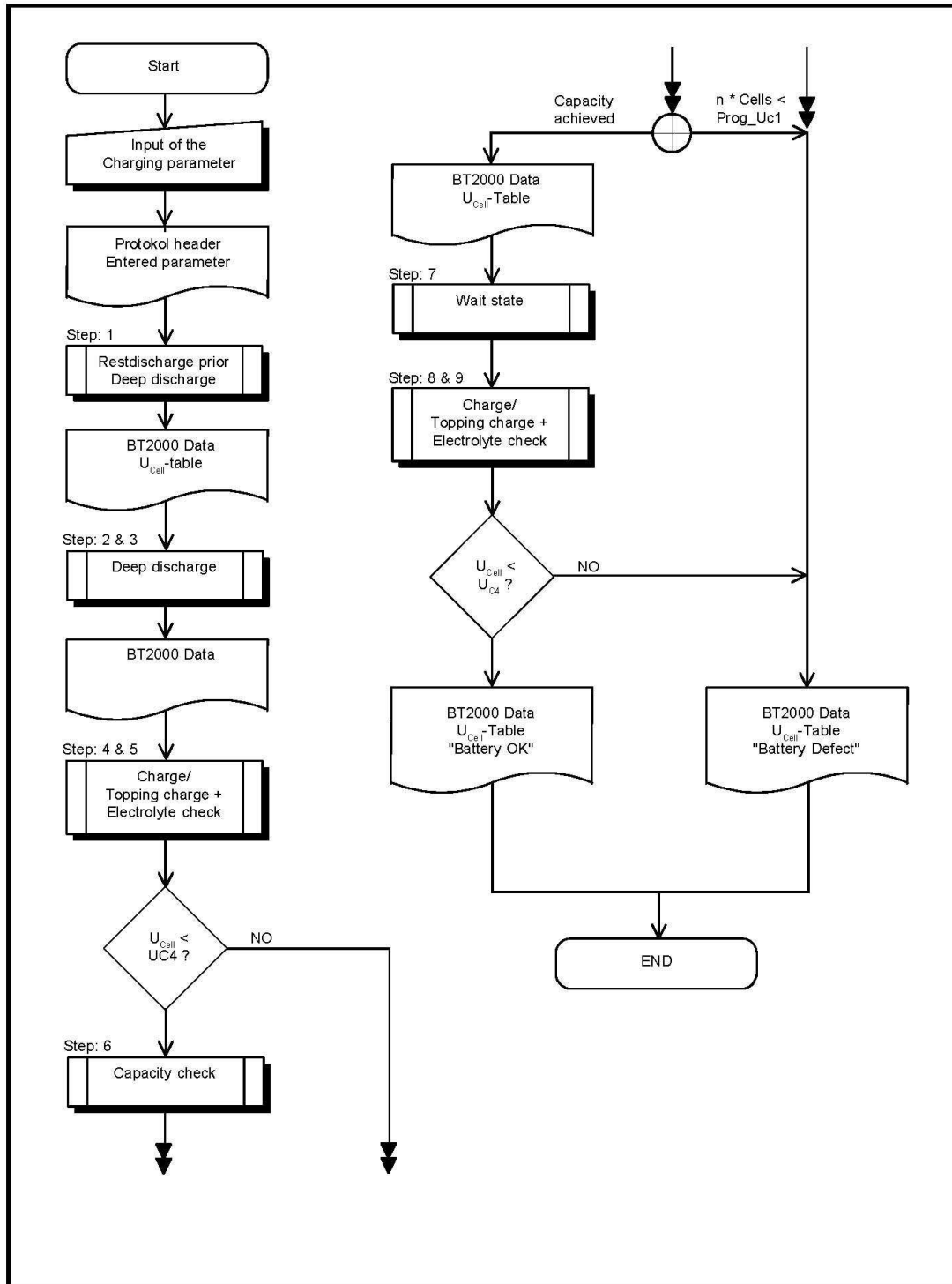

Figure 13: Program 8: Maintenance of Ni(Cd)-Batteries Code C (1000 Ah)

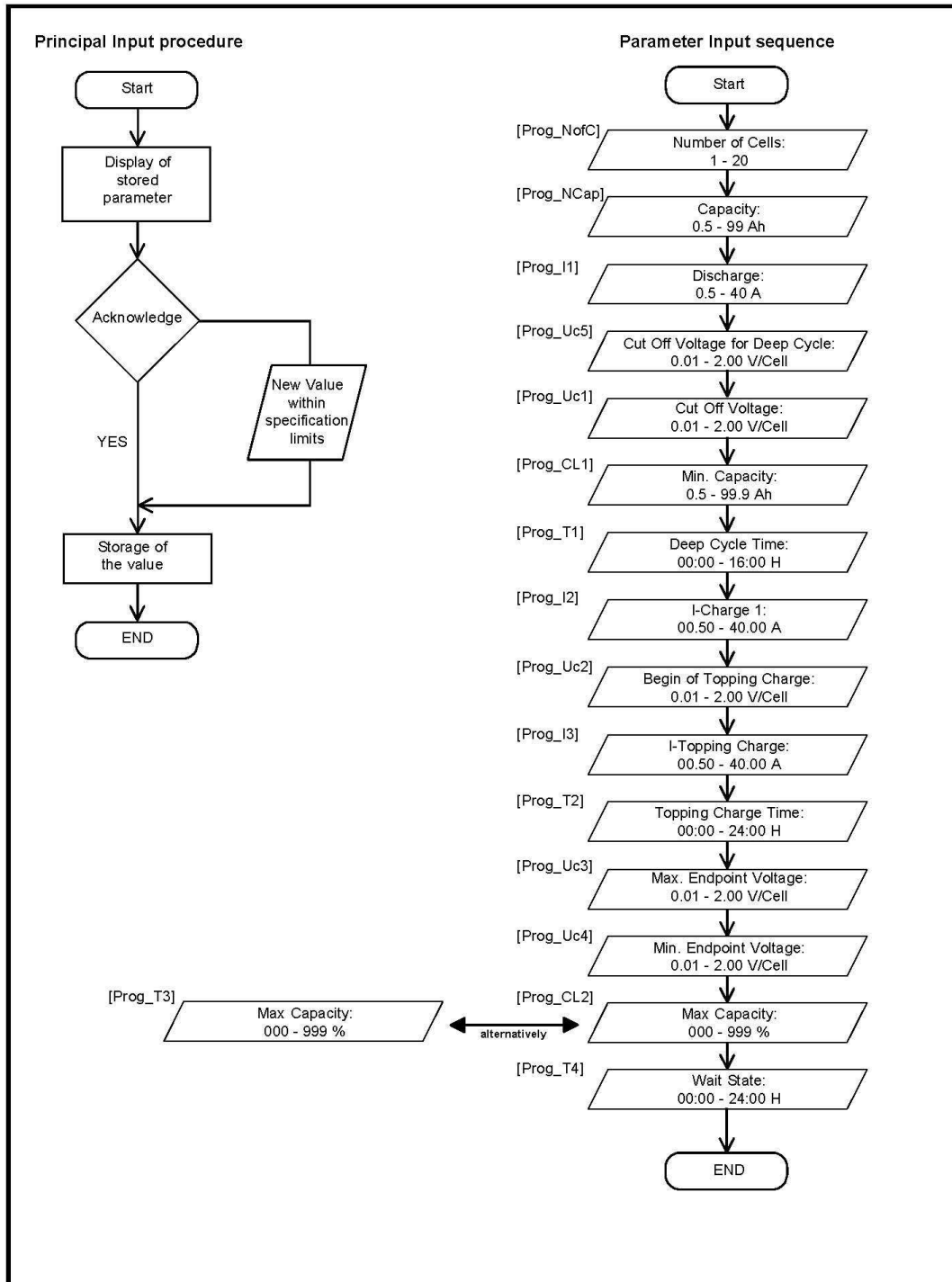

Figure 14: Program 8: Principal Input procedure and sequence of the parameters to be entered

2.5.10 Program 9: Maintenance of NiCad-Batteries Code F (2000Ah)

Program 9 is used for sealed NiCad Aeronautic Batteries with sinter electrodes.

The program is used to discharge the Battery after 2000Ah, check the electrolyte and rejuvenates the battery the best way.

SELECT PROGRAM (0 - 9,P,*) ? 4 23:44:55
P9: ANALYSIS OF NI/CD-BATTERIES CODE F

2.5.10.1 Parameter inputs

Following parameters have to be entered:

Number of cells (1 - 20 cells)

P9: PARAMETER INPUT ?
NUMBER OF CELLS 20 CELLS

Rated Capacity (0.5 to 99.9 Ah in 0.1 Ah-Steps)

P9: PARAMETER INPUT ?
RATED CAPACITY 23.00 AH

Discharge current

P9: PARAMETER INPUT ?
DISCHARGE 20.00 A

Cut Off Voltage Deep-Discharge (0.01 - 1.00 V/Cell)

P9: PARAMETER INPUT ?
CUT OFF VOLTAGE DEEP-DISCHARGE 0.10 V/C

Cut Off Voltage (0.01 - 1.00 V/Cell)

P9: PARAMETER INPUT ?
CUT OFF VOLTAGE 1.00 V/C

Min. Capacity (0.5 to 99.9Ah)

P9: PARAMETER INPUT ?
MIN. CAPACITY 23.00 AH

Deep Cycle Time (00:00 - 16:00H)

P9: PARAMETER INPUT ?
DEEP CYCLE TIME 08:00 H

I-Charge 1 (0.5 - 40.00A)

P9: PARAMETER INPUT ?
I-CHARGE 1 12.50 A

Begin of Toppingcharge (0.01 - 2.00 V/C)

P9: PARAMETER INPUT ?
BEGIN OF TOPPINGCHARGE 1.55 V/C

I-Toppingcharge (0.5 - 40.00 A)

P9: PARAMETER INPUT ?
I-TOPPINGCHARGE 2.3 A

Toppingcharge Time (00:00 - 24:00 H)

P9: PARAMETER INPUT ?
TOPPINGCHARGE TIME 04:00 H

Max. Endpoint Voltage per Cell (0.01 - 2.00V/C)

P9: PARAMETER INPUT ?
MAX. CELL ENDPPOINTVOLTAGE 1.80 V/C

Min. Endpoint Voltage per Cell (0.01 - 2.00 V/C)

P9: PARAMETER INPUT ?
MIN. CELL ENDPPOINTVOLTAGE 1.50 V/C

Max. Capacity (000 - 999%) or max charging time

P9: PARAMETER INPUT ?
MAX. CAPACITY 140 %
MAX. CHARGING TIME 16 H

Wait (00:00 - 16:00 H)

P9: PARAMETER INPUT ?
WAIT 01:00 H

Program Start

P9: PARAMETER INPUT ?
START WITH PRINT = P

2.5.10.2 Program steps

Program 9 consists of program steps S1 to S14

Step S1: DISCHARGE 1 (Rest-discharge) and Capacity Check

Discharging with constant-current C_5 (A) to discharging threshold-voltage of $\leq 1.0V$ / cell times amount of serially connected battery-cells and minimum dischargeable capacity.

P9: S1: RESTDISCHARGE

28.84 V 40.00 A 00.26 AH +00:30 H --°C

P9:S1: CAPACITYCHECK

28.84 V 40.00 A 00.26 AH +00:30 H --°C

Single cell-voltages are printed.

If the min. capacity is achieved, the program continues with sequence **A.)** (Step 2).

If cell-voltage is smaller than cut-off voltage (V/cell), the program continues with sequence **B.)** (Step 6)

A.) Min. Capacity is achieved

Step S2: DISCHARGE 1 (Restdischarge)

Discharging with constant-current C_2 (A) to discharging threshold-voltage of $\leq 1.0V$ / cell times amount of serially connected battery-cells.

P9: S2: RESTDISCHARGE

28.84 V 4.60 A 00.26 AH +00:30 H --°C

Step S3: Wait state

Programmed pause according to determined "wait" parameters before performing the final maintenance steps.

P9: S3: WAIT

23.14 V --.-- A 00.53 AH -01:30 H --°C

Step S4: I-CHARGE 1

Charging with constant-current (A) to the determined battery voltage (max. endpoint voltage), considering max. charging time determined and min. capacity.

P9: S4: I-CHARGE 1

28.84 V 23.00 A 00.34 AH +07:00 H --°C

Step S4: Check of elektrolyte level

The elektrolyte level has to be checked if max. endpoint voltage is not achieved.

P9: S4: CHECK ELEKTROLYTE

28.84 V --.-- A 15.58 AH +05:00 H --°C

Step S5: Begin of Topping charge

IU-charge with determined current (A) considering max. charging time and capacity.

P9: S5: BEGIN OF TOPPING CHARGE

28.84 V 02.30 A 15.58 AH +06:00 H -.-°C

Step S5: Topping Charge 1

Repetition of steps S4: I-Charge; in case of need check electrolyte level; parameters considered: charging time, capacity, residual charging time and max/min endpoint voltages.

P9: S5: TOPPING CHARGE 1

32.14 V 02.30 A 26.58 AH -03:30 H -.-°C

Printout of cell-voltages.

Program ends: Battery O.K.

B.) Cell-voltage is smaller than cut-off voltage (V/cell)

Step S6: DISCHARGE (Restdischarge)

Discharging with constant-current C_5 (A) to discharging threshold-voltage of $\leq 1.0V$ / cell times amount of serially connected battery-cells.

P9:S6: RESTDISCHARGE

28.84 V 4.60 A 00.26 AH +00:30 H -.-°C

Step S7: Deepdischarge

Deepdischarge with constant-current C (A) to discharging threshold-voltage of $\leq 1.0V$ (U_{Bat}), as long as $U_{Bat} > 1V$.

P9: S7: DEEPDISCHARGE

28.84 V 23.00 A 00.34 AH +21:69 H -.-°C

Step S8: Deepdischarge (Zero-Discharge)

Deepdischarge with constant-current C (A) V for determined Deep-Cycle-Time T, if $U_{Bat} < 1V$.

P9: S8: DEEPDISCHARGE

28.84 V 23.00 A 01.64 AH +22:00 H -.-°C

Step S9: I-CHARGE 1

Charging with constant-current (A) to the determined battery voltage (max. endpoint voltage), considering max. charging time determined and min. capacity.

P9: S9: I-CHARGE 1
28.84 V 23.00 A 00.34 AH +07:00 H -.-°C

Step S9: Check of electrolyte level

The electrolyte level has to be checked if max. endpoint voltage is not achieved.

P9: S9: CHECK ELEKTROLYTE
28.84 V --.-- A 15,.58 AH +05:00 H -.-°C

Step S10: Begin of Topping Charge

IU-Charge with determined current (A) considering max. charging time and capacity.

P9: S10: BEGIN OF TOPPING CHARGE
28.84 V 02.30 A 15.58 AH +06:00 H -.-°C

Step S10: Topping Charge 1

Repetition of steps S4: I-Charge; in case of need check electrolyte level; parameters considered: charging time, capacity, residual charging time and max/min endpoint voltages.

P9: S10: TOPPING CHARGE 1
32.14 V 02.30 A 26.58 AH -03:30 H -.-°C

Step S11: Capacity Check

Discharge with determined constant-current to determined Cut-off voltage considering min. dischargeable capacity.

P9: S11: CAPACITY CHECK
23.14 V 40.30 A 00.53 AH -01:30 H -.-°C

If min. capacity is achieved program continues with sequence C.) (step 12).

If cell-voltage is smaller than cut-off voltage (V/cell) program continues with sequence D.)

C.) Min. Capacity is achieved

Step S12: Wait state

Programmed pause according to determined "wait" parameters before performing the final charging steps.

P9: S12: WAIT
23.14 V --.-- A 00.53 AH -01:30 H -.-°C

Step S13: I-CHARGE 2

Charging with constant-current (A) to the determined battery voltage (max. endpoint voltage), considering max. charging time determined and min. capacity.

P9: S13: I-CHARGE 2
28.84 V 23.00 A 00.34 AH +07:00 H -.-°C

Step S13: Check of electrolyte level

The electrolyte level has to be checked if max. endpoint voltage is not achieved.

P9: S13: CHECK ELEKTROLYTE
28.84 V --.-- A 15.58 AH +05:00 H -.-°C

Step S14: Begin of Topping Charge

IU-Charge with determined current (A) considering max. charging time and capacity.

P9: S14: BEGIN OF TOPPING CHARGE
28.84 V 02.30 A 15.58 AH +06:00 H -.-°C

Step S14: Topping Charge 2

Repetition of steps S4: I-Charge; in case of need check electrolyte level; parameters considered: charging time, capacity, residual charging time and max/min endpoint voltages.

P9: S14: TOPPING CHARGE 2
32.14 V 02.30 A 26.58 AH -03:30 H -.-°C

With a printout of the cell voltages the program is finished: **Battery O.K.**

D.) Cell-voltage is smaller than cut-of voltage (V/cell)

With a printout of the cell voltages the program is finished: **Battery DEFEKT**

2.5.10.3 Monitoring functions**Program steps S4, S5, S8 and S9**

If the charged capacity exceeds 1,5 C the program is aborted and a fault message will be displayed.

Program steps S2, S3, S5 and S6

The temperature of the battery is monitored (if applicable):

If the temperature of the battery reaches 65°C, the program is interrupted and a fault indication will be displayed.

If since start of the charging process the temperature of the battery increases by more than 20°C and in between exceeds 30°C the program stops and a fault message is displayed.

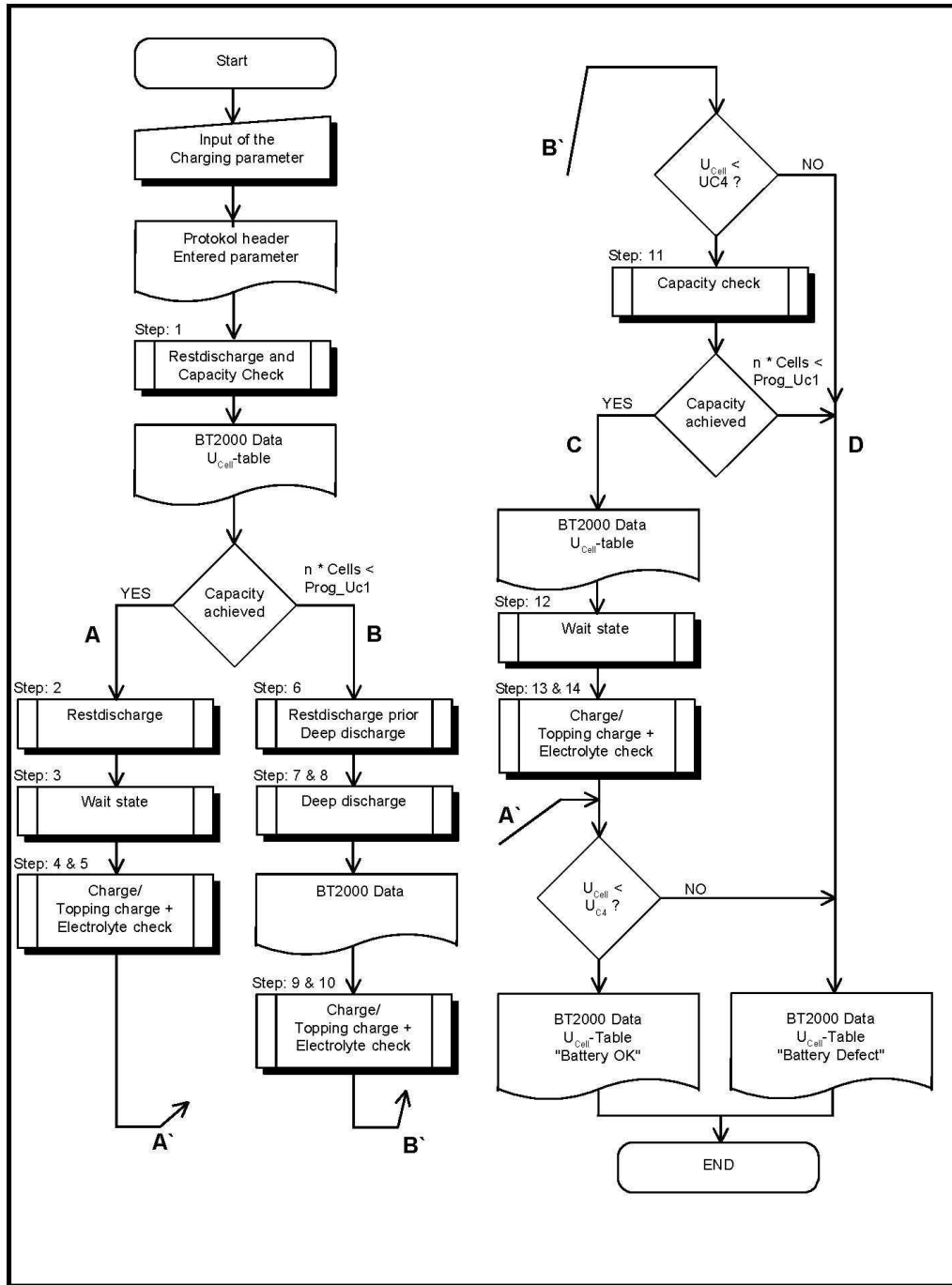

Figure 15: Program 9: Maintenance of Nc(Cd-Batteries Code F (2000 Ah)

2.5.11 Program P: Printer Usage and Cell-Voltage Measurement

The program P is a special routine for generation of a protocol printout as a function or independent of other programs. It is especially used for measurement and recording of cell-voltages.

The program is used in 4 situations:

- Automatic printout during program run
- Manual printout without activated program
- Manual Protocol-Generation within an active program without automatic protocol-generation
- Additional Protocol during Automatic-Protocol-Generation of an active program

Note for all 4 printer usages

Capacity values in % are related to the rated capacity of the battery.

The printout TEMPERATURE is provided only if both temperature sensors are connected. The printed value is the value from the battery terminal with the higher temperature.

NOTE to the "Cell-Voltage-Measurement"

The cell-voltage-measurement is only possible with manual printout selected. The start point is indicated by a short audible alarm. At this point it is possible to measure (Accessory "Cell-Tester required) and print cell voltages. The amount of cell-voltage-measurements is limited to 99.

Bad contact of the measuring probe (invalid measurement) is indicated by a short audible alarm. The measurement has to be repeated. The cell number is incremented with each valid measurement.

A "*" printed prior to a cell voltage value means the voltage is below 1.58 V. Thus a value measured at the correct point during the charging process (acc. manufacturers information) may point out an increased self discharging rate due to sludge or other battery defects.

If the single cell measurement function was not used the printout of cell numbers and values (Cell 01.....) is suppressed.

If during the print routine input requests are not answered by the user, after 30 seconds the program continues with the next request and finally continues with the normal program.

Example I: Program 2 automatically finished: Battery ok (including cell voltage measurement)

```

=====
COPYRIGHT (C)      JRR NORTEC
1987-1991 by      Reparaturen
-----
DATE               : 18.11.91
BATTERY NO        : 12.30.100
OPERATOR NO       : 123
RATED VOLTAGE     : 03.60   V
CAPACITY          : 12.0    AH
PROGRAM           : 2
-----
START OF PROGRAM   08:16:25
VOLTAGE            = 03.10   V
-----
P2:S1: I-CHARGE    09:33:17
VOLTAGE            = 04.50   V
CURRENT            = 11.99   A
CAPACITY           = 009.4   AH
                   = 078    %
TIME               = 060    MIN
-----
P2:S2: TOPPING CHARGE 10:42:19
VOLTAGE            = 04.65   V
CURRENT            = 02.40   A
CAPACITY           = 013.2   AH
                   = 110    %
TIME               = 000    MIN
-----
PROGRAM AUTOMATICLY FINNISHED
BATTERY OK
=====

```

By using of the automatic cell measurement adapter CT20 is the print out identical, but the cell voltage do not have to measure for each single cell manually.

Example 2: Program 2 automaticly finnished: Battery defect (Capcity to high)

```
=====
COPYRIGHT (C)   JRR NORTEC
1987-1991 by    Reparaturen
-----
DATE            : 18.07.91
BATTERY NO      : 12.30.100
OPERATOR NO     : 123
RATED VOLTAGE   : 03.60   V
CAPACITY        : 12.0    AH
PROGRAM         : 2
-----
START OF PROGRAM          08:16:25
VOLTAGE                   = 03.10 V
-----
P2:S1: I-CHARGE          09:33:17
VOLTAGE                   = 04.50 V
CURRENT                   = 11.99 A
CAPACITY                  = 015.3 AH
                          = 127   %
TIME                      = 076   MIN
-----
P2:S2: TOPPING CHARGE    10:42:19
VOLTAGE                   = 04.65 V
CURRENT                   = 02.40 A
CAPACITY                  = 018.1 AH
                          = 150   %
TIME                      = 022   MIN
-----
PROGRAM AUTOMATICLY FINNISHED
BATTERY OK
CAPACITY TO HIGH
=====
```

2.5.11.2 Manual printout without activated program

With this function a battery and its cell voltages may be measured without starting a charging or test program.

After actuating the key "P" the display shows following status:

SELECT PROGRAM (0 - 9,P,*) ? P 23:44:55
PRINTER

With actuating the key "E" the program is selected and following input is requested:

PP: PARAMETER INPUT
RATED VOLTAGE: 00.00 V

After entering the rated voltage and pressing the key "E" the next information is requested:

PP: PARAMETER INPUT
RATED CAPACITY: 00.00 AH

Actuating the key "E" starts the printout of the header and the display requests the next input:

PP: PARAMETER INPUT
BATTERY-NO: 873.234.1

A previously entered battery No. is indicated and may be overwritten or be accepted by actuating the key "E". The 9 digit number to be entered may consist of the numbers 0 to 9 and a decimal point.

After an audible signal the system requests the next information:

PP: PARAMETER INPUT
OPERATOR NO: 987654321

A previously entered operator No. is indicated and may be overwritten or be accepted by actuating the key "E". The 9 digit number to be entered may consist of the numbers 0 to 9 and a decimal point. Now after an audible signal following information is displayed:

PP: PARAMETER INPUT
*** CELL 01: 0.000 V**

The display shows the cell voltage of cell 1, measured with the cell tester. The measuring value is passed to the system by actuating the pushbutton of the cell tester.

Now the measurement of the subsequent cells is requested in ascending order:

PP: PARAMETER INPUT
*** CELL 02: 0.000 V**

For a battery of 10 cells the protocol shows following structure:

```
=====
COPYRIGHT (C)      JRR NORTEC
1987-1991 by       Reparaturen
-----
DATE                : 18.07.91
BATTEY NO           : 123
OPERATOR NO         : 456
RATED VOLTAGE       : 12.00   V
CAPACITY            : 001.2   AH
PROGRAM             : P
-----
START OFPROGRAM     : 08:16:25
VOLTAGE              = 13.79   V
TEMPERATURE          = 33.9    °C
-----
* CELL 01           : 1,381   V
* CELL 02           : 1,379   V
* CELL 03           : 1,377   V
* CELL 04           : 1,376   V
* CELL 05           : 1,375   V
* CELL 06           : 1,377   V
* CELL 07           : 1,374   V
* CELL 08           : 1,380   V
* CELL 09           : 1,378   V
* CELL 10           : 1,376   V
-----
=====
```

2.5.11.3 Manual printout without automatic protocol generation selected

With this selection it is possible to insert a printout at any time although the automatic printout was not selected before.

At the desired moment the pushbutton "P" is actuated. First of all the header with the standard battery parameter is printed. Then the program asks for battery and operator number:

P2: S1: I-CHARGE
BATTERY NO: 873.234.1

A previously entered battery No. is indicated and may be overwritten or be accepted by actuating the key "E". The 9 digit number to be entered may consist of the numbers 0 to 9 and a decimal point:

P2: S1: I-CHARGE
OPERATOR NO: 987654321

A previously entered operator No. is indicated and may be overwritten or be accepted by actuating the key "E". The 9 digit number to be entered may consist of the numbers 0 to 9 and a decimal point.

Now the actual program and battery data are printed:

P2: I-CHARGE
*** CELL 01: 0.000 V**

The display shows the cell voltage of cell 1, measured with the cell tester. The measuring value is passed to the system by actuating the pushbutton of the cell tester.

Now the measurement of the subsequent cells is requested in ascending order:

P2: I-CHARGE
*** CELL 02: 0.000 V**

After the last measurement the key "E" is actuated to finish the cell-voltage-measurement. If the key is not actuated after a delay the system switches back to the standard program.

For a battery of 10 cells the protocol shows following structure:

```

=====
COPYRIGHT (C)      JRR NORTEC
1987-1991 by       Reparaturen
-----
DATE               : 18.07.91
BATTERY NO         : 123
OPERATOR NO        : 456
RATED VOLTAGE      : 01.20    V
CAPACITY           : 001.2    AH
PROGRAM            : 5
-----
P5:S1: DISCHARGE   08:16:25
VOLTAGE            = 13.77    V
CURRENT            = 01.20    A
CAPACITY           = 000.1    AH
                   = 010.0    %
TEMPERATURE        = 23.9     °C
TIME               = 006      MIN
-----
* CELL 01          : 1.378    V
* CELL 02          : 1.379    V
* CELL 03          : 1.377    V
* CELL 04          : 1.376    V
* CELL 05          : 1.375    V
* CELL 06          : 1.377    V
* CELL 07          : 1.374    V
* CELL 08          : 1.380    V
* CELL 09          : 1.378    V
* CELL 10          : 1.376    V
-----
=====
    
```

2.5.11.4 Additional Protocol during Automatic-Protocol-Generation of an active program

With this routine it is possible to insert printouts in addition to the standard selected protocols.

At the desired moment the pushbutton "P" is actuated. Immediately in between of the standard protocols an additional printout of the actual battery parameter is inserted.

```

=====
COPYRIGHT (C)      JRR NORTEC
1987-1991 by      Reparaturen
-----
DATE               : 18.07.91
BATTERY NO        : 12.30.100
OPERATOR NO       : 123
RATED VOLTAGE     : 03.60   V
CAPACITY          : 12.0    AH
PROGRAM           : 2
-----
START OF PROGRAM   : 08:16:25
VOLTAGE           = 03.10   V
-----
P2:S1: I-CHARGE   : 09:33:17
VOLTAGE           = 04.50   V
CURRENT           = 12.00   A
CAPACITY          = 009.4   AH
                  = 078     %
TIME              = 060     MIN
-----
P2:S1: I-CHARGE   : 09:35:17
VOLTAGE           = 04.60   V
CURRENT           = 12.00   A
CAPACITY          = 009.5   AH
                  = 079     %
TIME              = 062     MIN
-----
* CELL 01         = 1,477   V
* CELL 02         = 1,480   V
* CELL 03         = 1,478   V
-----
P2:S2: NACHLADUNG : 10:42:19
VOLTAGE           = 04.65   V
CURRENT           = 02.40   A
CAPACITY          = 013.2   AH
                  = 110     %
RESTZEIT          = 000     MIN
-----
PROGRAM AUTOMATICLY FINNISHED
BATTERY OK
=====

```

2.5.11.5 Paper and ink ribbon Replacement

To replace paper and ink ribbon, the printer has to be taken out of the BT2000 by loosening the two knurled-head screws on the front panel of the printer.

The paper holder is accessible from below the printer slide-in unit. The new paper coil (paper width 58 mm/diameter 50 mm max) has to be inserted into the spring-clips with paper end pointing to the front panel feeding from bottom to top.

The right angle cut paper is fed through the cutout on top of the printer slide-in unit. From there it has to be carefully inserted into the feed-in slot on top of the printing mechanism mounted behind the front panel. Tighten the paper by moving the paper coil carefully, taking care that the paper end does not slide out of the feed-in slot. Now insert the printer into the BT2000 and tighten the knurled-head screws. After switching on the BT2000 the pushbutton on the front panel of the printer has to be actuated until the paper appears at the sharp edge on the front panel. (If the paper does not feed automatically it can be fed manually by moving the upper coil accessible behind the ink ribbon box)

To exchange the ink ribbon the printer has to be removed from the BT2000 as described above. Then the upper part of the front panel has to be removed from the printer unit by pulling it upwards. Now the ink ribbon box is accessible from the front of the unit. The box now can be disconnected from the drive wheel of the printing mechanism, by slightly pushing on the side inscribed with "PUSH".

The ink ribbon of the new box is tightened by turning the knob on the box (direction indicated by an arrow). Now insert the ink ribbon box (tightening-knob left front side), feeding the paper between casing and ink ribbon. After installing the upper part of the printer front panel insert the printer into the BT2000 and tighten the knurled-head screws.

2.5.11.6 Printer test

The printer test is performed by simultaneously actuating the green pushbutton on the front panel of the printer and switching on the BT2000. This generates a printout of the complete character set of the printer.

Picture 16: Printer (Replacement of ink ribbon and paper coil)

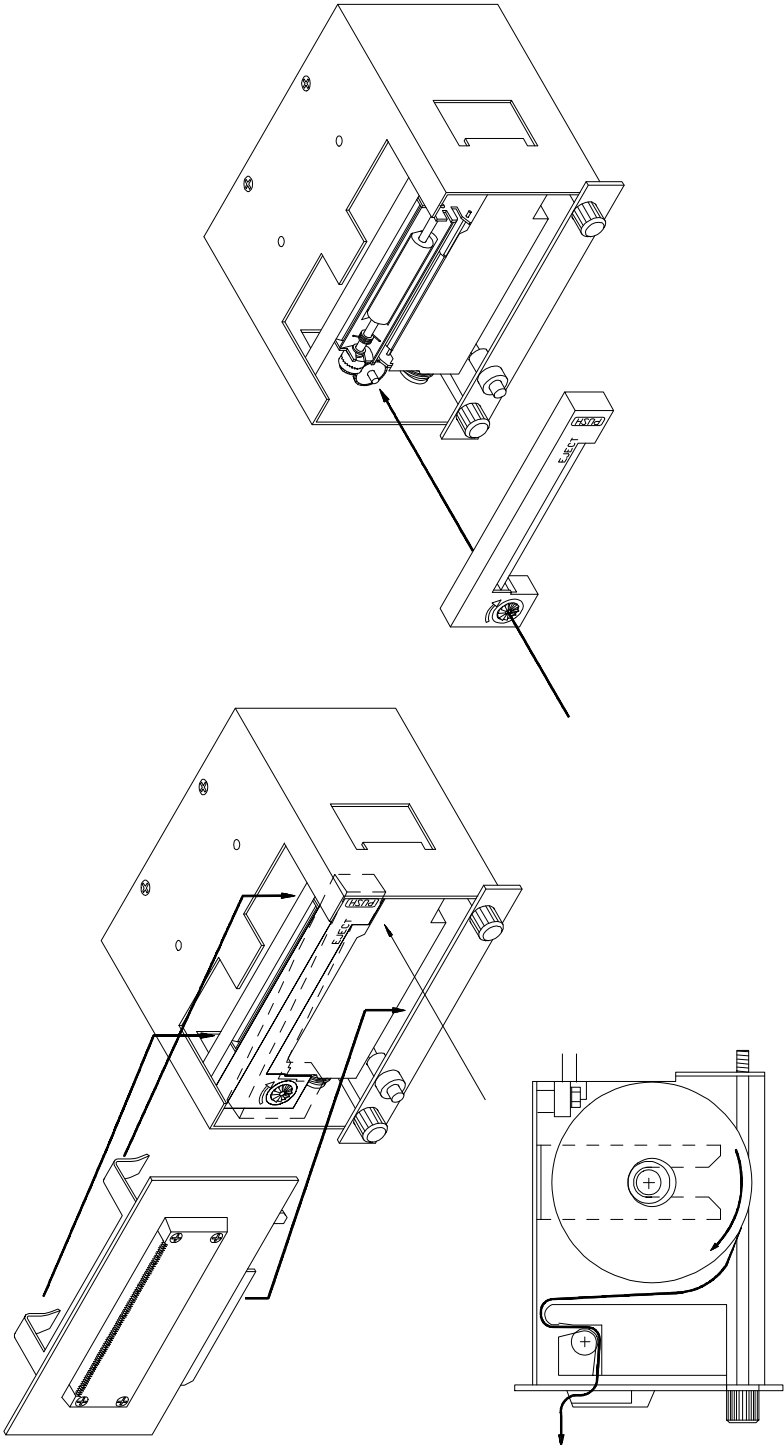

2.5.12 Program *: Setting of date and time

The program * is used for setting date and time via the keyboard.

Entering date and time:

SELECT PROGRAM (0 - 9,P,*) ? * **23:44:55**
***: DATE/CLOCK SET**

Date and time are entered via the keyboard, e.g. 01.11.91 and 16:03:45.

The entered date and time information is stable for a period of approx. 5 years (internal battery). Nevertheless they should be verified cyclically and be corrected if required.

Before the end of the life time of the timer battery the equipment should be sent to NorTec or a licensed service shop for exchange of the battery.

3 Fault-Messages

Based on its structure the BT2000 recognizes various faults and during active programs monitors the connected battery on different technical parameters and safety criteria.

Principally a selected function cannot be continued after a fault occurred.

If the fixed technical parameters or safety criteria are exceeded, active programs are automatically interrupted and the BT2000 generates a continuous audible alarm, which has to be acknowledged by actuating the key E = ENTER.

3.1 Hardware failures

Following fault indications may be displayed during self test after switching on the equipment:

**FAILURE EQUIPMENT:
LOW VOLTAGE ON BATTERY**

**FAILURE EQUIPMENT:
RANDOM ACCESS MEMORY**

**FAILURE EQUIPMENT:
PRINTER INTERFACE**

**FAILURE EQUIPMENT:
KEYBOARD INTERFACE**

**FAILURE EQUIPMENT:
AD-CONVERTER**

**FAILURE EQUIPMENT:
SYSTEM-TIMER (CTC)**

**FAILURE EQUIPMENT:
CLOCK NOT FOUND**

**FAILURE EQUIPMENT:
POWER-CIRCUIT OR ADC**

**FAILURE EQUIPMENT:
DAC OR REGULATOR UNIT**

In case of an indication of one of the a.m. failures the equipment should be sent to the manufacturer with a short note about the failure indication enclosed.

3.2 System failure

The following fault indications may be displayed during selection of programs or during program run.

FAILURE: CHECK BATTERY CONNECTION

This alarm appears at following situations:

- No battery connected when starting a program
- Battery is connected with wrong polarity
- Battery connection-cables are shortened
- One connection-cable fallen off the terminal

FAILURE: CHECK CONNECTION CABLE

This alarm is indicated if the voltage-sense-wire in the connection-cables is broken or interrupted, or the cable is not connected correctly.

FAILURE EQUIPMENT: AMPLIFIER DEFECT

FAILURE EQUIPMENT: FUSE Si3-1/RELAIS/SNT/REGULATOR

FAILURE EQUIPMENT: CURRENT TO HIGH

In case of an indication of one of the a.m. failures the equipment should be sent to the manufacturer with short note about the failure indication enclosed.

3.3 Battery faults

The following fault indications are displayed during program run or after finishing a program. They provide information about the life conditions of the battery

FAILURE BATTERY CURRENT TOO LOW

This message is displayed if within a period of a program step the current does not exceed the determined minimum level (e.g.: Program 3, maintenance cycle for sealed lead-acid-batteries).

FAILURE BATTERY CURRENT TOO HIGH

This fault-message is indicated when the charging current is too high at the end of a program step (e.g.: Program 4, charging of sealed lead-acid-batteries).

FAILURE BATTERY CAPACITY TO LOW

This message is indicated if a charging process does not achieve the determined minimum capacity (e.g.: Program 3).

FAILURE BATTERY CAPACITY TO HIGH

This message is displayed if the charged capacity exceeds a determined maximum (e.g.: Program1).

FAILURE BATTERY BATTERY TEMPERATURE TOO HIGH

Fault indication in case of the temperature of one battery terminal reaches 65°C or if since begin of the charging period the temperature of the battery increases by more than 20°C and in between exceeds 30°C.

NOTE

The message BATTERY TEMPERATURE TOO HIGH (BATTERIETEMPERATUR ZU HOCH) is generated only, if the battery-connection-cables are provided with temperature-sensors.

4 Installation

The battery-analyzer/-charger BT2000 is designed for inside usage. Under certain ambient conditions, it can be also used outside.

The room in which the equipment is to be installed does not require special construction. The minimum requirement is a 230 V / 50 Hz mains-supply, fused with minimum 20A.

The maximum power consumption is 2000 W or 3000 VA.

The most important point to be considered is the internal ventilation of the equipment.

Complying with the following directions ensures a safe operation of the BT2000:

- when operating the equipment on a plain surface, leave a clearance of 25 cm between the back of the casing and the wall
- use the mounting-bracket
- use a special casing for mobile operation

Generally, it has to be considered that the equipment requires several m³ cooling-air per minute.

5 Definitions

The chapter "Definitions" comprises an overview about abbreviations and terms used in this documentation:

5.1 Battery, sealed

The term "sealed battery" denotes a maintenance-free battery with fixed electrolyte, which has been provided with non-removable locking-caps by the manufacturer.

5.2 Battery, vented

The term "vented battery" denotes a battery, on which conventional maintenance as density measurements and revilement of distilled water can be performed by removing the screw-cap of the cell.

5.3 Rechargeable silver-zinc-battery

Rechargeable silver-zinc-batteries are a combination of sealed and vented batteries.

They are delivered and stored in charged but not filled state. To put them into operation they are filled with potash lye electrolyte, which is delivered separately for each cell in a special barrel.

After that the batteries are closed with locking caps similar to those of vented NiCad-batteries

During the approx. 18 month lifetime of the battery no further maintenance measures have to be taken.

5.4 Charging/Discharging-Threshold-Voltage

The charging/discharging-threshold-voltage is defined by the manufacturer. It is the voltage level to which a battery can be charged or discharged without being damaged.

5.5 Rated voltage

The rated voltage is a characteristic quantity based on the battery technology (e.g.: lead-acid-batteries: 2V/cell; NiCad-batteries: 1.2 v/cell).

In relation to charging/discharging programs, created for different battery-technologies, the term "rated voltage" or "nominal voltage" is also used for change over levels defined by the product of number of cells and voltage.

5.6 Rated Capacity = C_5

The rated capacity (Ah) as magnitude of a battery is based on a fixed discharge to a defined discharge threshold voltage at a defined reference temperature (5hours discharging current, battery temperature, discharging threshold voltage; values depending on battery-technology).

5.7 Rated Current or 0.2 C₅ (A)

5 hours discharging current (formerly I₅) of a battery, calculated as follows:

$$\frac{C_5 \text{ (Ah)}}{5\text{h}} = 0.2 C_5 \text{ (A)}$$

5.8 Cell voltage

Within charging or discharging programs designed for different battery-technologies the term “cell voltage” is used in combination with the number of cells of the battery to be maintained, to define a program specific change-over-voltage.

5.9 Analysis cycle / Maintenance cycle

The terms “analysis cycle / maintenance cycle” are to be understood as a discharging-charging-discharging-charging-cycle required to determine the actual performance of a battery and prepare it for further usage.

5.10 Charge

The term “charge” defines a non damaging full-charge of a battery in minimum time. Immediately after finishing the charge the battery can be used again.

Note

Terms not explained here will be understood by reading the program descriptions.(e.g. IU-CHARGE, IUI-CHARGE or similar abbreviations.)