

R&S® SMA100A Signal Generator Operating Manual



1400.0075.32 – 10



Test with full trust
www.avionteq.com

To buy, sell, rent or trade-in this product please click on the link below:
<http://www.avionteq.com/Rohde-and-Schwarz-SMA100A-RF-VOR-ILS-DME-Signal-Generator.aspx>

Test & Measurement

Operating Manual

This document describes the R&S®SMA100A, stock no. 1400.0000k02 and its options.

- R&S®SMA-B20
- R&S®SMA-B22
- R&S®SMA-B29
- R&S®SMA-B46
- R&S®SMA-B80/B81
- R&S®SMA-B103/B103L
- R&S®SMA-B106/B106L
- R&S®SMA-K23/K27
- R&S®SMA-K24
- R&S®SMA-K25
- R&S®SMA-K26
- R&S®SMA-K28

The firmware of the instrument makes use of the operating system LINUX® and other valuable open source software packages. The most important of them together with their corresponding open source license and the verbatim license texts are provided on the user documentation CD-ROM (included in delivery).

The OpenSSL Project for use in the OpenSSL Toolkit (<http://www.openssl.org/>) includes cryptographic software written by Eric Young (eay@cryptsoft.com) and software written by Tim Hudson (tjh@cryptsoft.com). LINUX® is a trademark of Linus Torvalds.

Rohde & Schwarz would like to thank the open source community for their valuable contribution to embedded computing.

© 2012 Rohde & Schwarz GmbH & Co. KG

Muehldorfstr. 15, 81671 Munich, Germany

Phone: +49 89 41 29 - 0

Fax: +49 89 41 29 12 164

E-mail: info@rohde-schwarz.com

Internet: <http://www.rohde-schwarz.com>

Subject to change – Data without tolerance limits is not binding.

R&S® is a registered trademark of Rohde & Schwarz GmbH & Co. KG.

Trade names are trademarks of the owners.

The following abbreviations are used throughout this manual: R&S®SMA100A is abbreviated as R&S SMA.

Basic Safety Instructions

Always read through and comply with the following safety instructions!



All plants and locations of the Rohde & Schwarz group of companies make every effort to keep the safety standards of our products up to date and to offer our customers the highest possible degree of safety. Our products and the auxiliary equipment they require are designed, built and tested in accordance with the safety standards that apply in each case. Compliance with these standards is continuously monitored by our quality assurance system. The product described here has been designed, built and tested in accordance with the attached EC Certificate of Conformity and has left the manufacturer's plant in a condition fully complying with safety standards. To maintain this condition and to ensure safe operation, you must observe all instructions and warnings provided in this manual. If you have any questions regarding these safety instructions, the Rohde & Schwarz group of companies will be happy to answer them.

Furthermore, it is your responsibility to use the product in an appropriate manner. This product is designed for use solely in industrial and laboratory environments or, if expressly permitted, also in the field and must not be used in any way that may cause personal injury or property damage. You are responsible if the product is used for any purpose other than its designated purpose or in disregard of the manufacturer's instructions. The manufacturer shall assume no responsibility for such use of the product.











The product is used for its designated purpose if it is used in accordance with its product documentation and within its performance limits (see data sheet, documentation, the following safety instructions). Using the product requires technical skills and, in some cases, a basic knowledge of English. It is therefore essential that only skilled and specialized staff or thoroughly trained personnel with the required skills be allowed to use the product. If personal safety gear is required for using Rohde & Schwarz products, this will be indicated at the appropriate place in the product documentation. Keep the basic safety instructions and the product documentation in a safe place and pass them on to the subsequent users.

Observing the safety instructions will help prevent personal injury or damage of any kind caused by dangerous situations. Therefore, carefully read through and adhere to the following safety instructions before and when using the product. It is also absolutely essential to observe the additional safety instructions on personal safety, for example, that appear in relevant parts of the product documentation. In these safety instructions, the word "product" refers to all merchandise sold and distributed by the Rohde & Schwarz group of companies, including instruments, systems and all accessories. For product-specific information, see the data sheet and the product documentation.

Symbols and safety labels

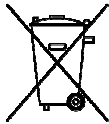
Symbol	Meaning	Symbol	Meaning
	Notice, general danger location Observe product documentation	○	ON/OFF supply voltage
	Caution when handling heavy equipment	⏻	Standby indication
	Danger of electric shock	— — —	Direct current (DC)

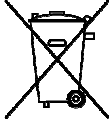
Basic Safety Instructions

Symbol	Meaning	Symbol	Meaning
	Warning! Hot surface		Alternating current (AC)
	Protective conductor terminal		Direct/alternating current (DC/AC)
	Ground		Device fully protected by double (reinforced) insulation
	Ground terminal		EU labeling for batteries and accumulators For additional information, see section "Waste disposal/Environmental protection", item 1.
	Be careful when handling electrostatic sensitive devices		EU labeling for separate collection of electrical and electronic devices For additional information, see section "Waste disposal/Environmental protection", item 2.
	Warning! Laser radiation For additional information, see section "Operation", item 7.		

Signal words and their meaning

The following signal words are used in the product documentation in order to warn the reader about risks and dangers.



Indicates an imminently hazardous situation which, if not avoided, will result in death or serious injury.



Indicates a potentially hazardous situation which, if not avoided, could result in death or serious injury.



Indicates a potentially hazardous situation which, if not avoided, could result in minor or moderate injury.



Indicates the possibility of incorrect operation which can result in damage to the product.

In the product documentation, the word ATTENTION is used synonymously.

These signal words are in accordance with the standard definition for civil applications in the European Economic Area. Definitions that deviate from the standard definition may also exist in other economic areas or military applications. It is therefore essential to make sure that the signal words described here are always used only in connection with the related product documentation and the related product. The use of signal words in connection with unrelated products or documentation can result in misinterpretation and in personal injury or material damage.

Basic Safety Instructions

Operating states and operating positions

The product may be operated only under the operating conditions and in the positions specified by the manufacturer, without the product's ventilation being obstructed. If the manufacturer's specifications are not observed, this can result in electric shock, fire and/or serious personal injury or death. Applicable local or national safety regulations and rules for the prevention of accidents must be observed in all work performed.

1. Unless otherwise specified, the following requirements apply to Rohde & Schwarz products: predefined operating position is always with the housing floor facing down, IP protection 2X, use only indoors, max. operating altitude 2000 m above sea level, max. transport altitude 4500 m above sea level. A tolerance of $\pm 10\%$ shall apply to the nominal voltage and $\pm 5\%$ to the nominal frequency, overvoltage category 2, pollution severity 2.
2. Do not place the product on surfaces, vehicles, cabinets or tables that for reasons of weight or stability are unsuitable for this purpose. Always follow the manufacturer's installation instructions when installing the product and fastening it to objects or structures (e.g. walls and shelves). An installation that is not carried out as described in the product documentation could result in personal injury or even death.
3. Do not place the product on heat-generating devices such as radiators or fan heaters. The ambient temperature must not exceed the maximum temperature specified in the product documentation or in the data sheet. Product overheating can cause electric shock, fire and/or serious personal injury or even death.

Electrical safety

If the information on electrical safety is not observed either at all or to the extent necessary, electric shock, fire and/or serious personal injury or death may occur.

1. Prior to switching on the product, always ensure that the nominal voltage setting on the product matches the nominal voltage of the AC supply network. If a different voltage is to be set, the power fuse of the product may have to be changed accordingly.
2. In the case of products of safety class I with movable power cord and connector, operation is permitted only on sockets with a protective conductor contact and protective conductor.
3. Intentionally breaking the protective conductor either in the feed line or in the product itself is not permitted. Doing so can result in the danger of an electric shock from the product. If extension cords or connector strips are implemented, they must be checked on a regular basis to ensure that they are safe to use.
4. If there is no power switch for disconnecting the product from the AC supply network, or if the power switch is not suitable for this purpose, use the plug of the connecting cable to disconnect the product from the AC supply network. In such cases, always ensure that the power plug is easily reachable and accessible at all times. For example, if the power plug is the disconnecting device, the length of the connecting cable must not exceed 3 m. Functional or electronic switches are not suitable for providing disconnection from the AC supply network. If products without power switches are integrated into racks or systems, the disconnecting device must be provided at the system level.
5. Never use the product if the power cable is damaged. Check the power cables on a regular basis to ensure that they are in proper operating condition. By taking appropriate safety measures and carefully laying the power cable, ensure that the cable cannot be damaged and that no one can be hurt by, for example, tripping over the cable or suffering an electric shock.

Basic Safety Instructions

6. The product may be operated only from TN/TT supply networks fuse-protected with max. 16 A (higher fuse only after consulting with the Rohde & Schwarz group of companies).
7. Do not insert the plug into sockets that are dusty or dirty. Insert the plug firmly and all the way into the socket provided for this purpose. Otherwise, sparks that result in fire and/or injuries may occur.
8. Do not overload any sockets, extension cords or connector strips; doing so can cause fire or electric shocks.
9. For measurements in circuits with voltages $V_{rms} > 30$ V, suitable measures (e.g. appropriate measuring equipment, fuse protection, current limiting, electrical separation, insulation) should be taken to avoid any hazards.
10. Ensure that the connections with information technology equipment, e.g. PCs or other industrial computers, comply with the IEC60950-1/EN60950-1 or IEC61010-1/EN 61010-1 standards that apply in each case.
11. Unless expressly permitted, never remove the cover or any part of the housing while the product is in operation. Doing so will expose circuits and components and can lead to injuries, fire or damage to the product.
12. If a product is to be permanently installed, the connection between the protective conductor terminal on site and the product's protective conductor must be made first before any other connection is made. The product may be installed and connected only by a licensed electrician.
13. For permanently installed equipment without built-in fuses, circuit breakers or similar protective devices, the supply circuit must be fuse-protected in such a way that anyone who has access to the product, as well as the product itself, is adequately protected from injury or damage.
14. Use suitable overvoltage protection to ensure that no overvoltage (such as that caused by a bolt of lightning) can reach the product. Otherwise, the person operating the product will be exposed to the danger of an electric shock.
15. Any object that is not designed to be placed in the openings of the housing must not be used for this purpose. Doing so can cause short circuits inside the product and/or electric shocks, fire or injuries.
16. Unless specified otherwise, products are not liquid-proof (see also section "Operating states and operating positions", item 1). Therefore, the equipment must be protected against penetration by liquids. If the necessary precautions are not taken, the user may suffer electric shock or the product itself may be damaged, which can also lead to personal injury.
17. Never use the product under conditions in which condensation has formed or can form in or on the product, e.g. if the product has been moved from a cold to a warm environment. Penetration by water increases the risk of electric shock.
18. Prior to cleaning the product, disconnect it completely from the power supply (e.g. AC supply network or battery). Use a soft, non-linting cloth to clean the product. Never use chemical cleaning agents such as alcohol, acetone or diluents for cellulose lacquers.

Operation

1. Operating the products requires special training and intense concentration. Make sure that persons who use the products are physically, mentally and emotionally fit enough to do so; otherwise, injuries or material damage may occur. It is the responsibility of the employer/operator to select suitable personnel for operating the products.

Basic Safety Instructions

2. Before you move or transport the product, read and observe the section titled "Transport".
3. As with all industrially manufactured goods, the use of substances that induce an allergic reaction (allergens) such as nickel cannot be generally excluded. If you develop an allergic reaction (such as a skin rash, frequent sneezing, red eyes or respiratory difficulties) when using a Rohde & Schwarz product, consult a physician immediately to determine the cause and to prevent health problems or stress.
4. Before you start processing the product mechanically and/or thermally, or before you take it apart, be sure to read and pay special attention to the section titled "Waste disposal/Environmental protection", item 1.
5. Depending on the function, certain products such as RF radio equipment can produce an elevated level of electromagnetic radiation. Considering that unborn babies require increased protection, pregnant women must be protected by appropriate measures. Persons with pacemakers may also be exposed to risks from electromagnetic radiation. The employer/operator must evaluate workplaces where there is a special risk of exposure to radiation and, if necessary, take measures to avert the potential danger.
6. Should a fire occur, the product may release hazardous substances (gases, fluids, etc.) that can cause health problems. Therefore, suitable measures must be taken, e.g. protective masks and protective clothing must be worn.
7. Laser products are given warning labels that are standardized according to their laser class. Lasers can cause biological harm due to the properties of their radiation and due to their extremely concentrated electromagnetic power. If a laser product (e.g. a CD/DVD drive) is integrated into a Rohde & Schwarz product, absolutely no other settings or functions may be used as described in the product documentation. The objective is to prevent personal injury (e.g. due to laser beams).
8. EMC classes (in line with CISPR 11)
Class A: Equipment suitable for use in all environments except residential environments and environments that are directly connected to a low-voltage supply network that supplies residential buildings.
Class B: Equipment suitable for use in residential environments and environments that are directly connected to a low-voltage supply network that supplies residential buildings.

Repair and service

1. The product may be opened only by authorized, specially trained personnel. Before any work is performed on the product or before the product is opened, it must be disconnected from the AC supply network. Otherwise, personnel will be exposed to the risk of an electric shock.
2. Adjustments, replacement of parts, maintenance and repair may be performed only by electrical experts authorized by Rohde & Schwarz. Only original parts may be used for replacing parts relevant to safety (e.g. power switches, power transformers, fuses). A safety test must always be performed after parts relevant to safety have been replaced (visual inspection, protective conductor test, insulation resistance measurement, leakage current measurement, functional test). This helps ensure the continued safety of the product.

Basic Safety Instructions

Batteries and rechargeable batteries/cells

If the information regarding batteries and rechargeable batteries/cells is not observed either at all or to the extent necessary, product users may be exposed to the risk of explosions, fire and/or serious personal injury, and, in some cases, death. Batteries and rechargeable batteries with alkaline electrolytes (e.g. lithium cells) must be handled in accordance with the EN 62133 standard.

1. Cells must not be taken apart or crushed.
2. Cells or batteries must not be exposed to heat or fire. Storage in direct sunlight must be avoided. Keep cells and batteries clean and dry. Clean soiled connectors using a dry, clean cloth.
3. Cells or batteries must not be short-circuited. Cells or batteries must not be stored in a box or in a drawer where they can short-circuit each other, or where they can be short-circuited by other conductive materials. Cells and batteries must not be removed from their original packaging until they are ready to be used.
4. Cells and batteries must not be exposed to any mechanical shocks that are stronger than permitted.
5. If a cell develops a leak, the fluid must not be allowed to come into contact with the skin or eyes. If contact occurs, wash the affected area with plenty of water and seek medical aid.
6. Improperly replacing or charging cells or batteries that contain alkaline electrolytes (e.g. lithium cells) can cause explosions. Replace cells or batteries only with the matching Rohde & Schwarz type (see parts list) in order to ensure the safety of the product.
7. Cells and batteries must be recycled and kept separate from residual waste. Rechargeable batteries and normal batteries that contain lead, mercury or cadmium are hazardous waste. Observe the national regulations regarding waste disposal and recycling.

Transport

1. The product may be very heavy. Therefore, the product must be handled with care. In some cases, the user may require a suitable means of lifting or moving the product (e.g. with a lift-truck) to avoid back or other physical injuries.
2. Handles on the products are designed exclusively to enable personnel to transport the product. It is therefore not permissible to use handles to fasten the product to or on transport equipment such as cranes, fork lifts, wagons, etc. The user is responsible for securely fastening the products to or on the means of transport or lifting. Observe the safety regulations of the manufacturer of the means of transport or lifting. Noncompliance can result in personal injury or material damage.
3. If you use the product in a vehicle, it is the sole responsibility of the driver to drive the vehicle safely and properly. The manufacturer assumes no responsibility for accidents or collisions. Never use the product in a moving vehicle if doing so could distract the driver of the vehicle. Adequately secure the product in the vehicle to prevent injuries or other damage in the event of an accident.

Waste disposal/Environmental protection

1. Specially marked equipment has a battery or accumulator that must not be disposed of with unsorted municipal waste, but must be collected separately. It may only be disposed of at a suitable collection point or via a Rohde & Schwarz customer service center.

Instrucciones de seguridad elementales

2. Waste electrical and electronic equipment must not be disposed of with unsorted municipal waste, but must be collected separately.
Rohde & Schwarz GmbH & Co. KG has developed a disposal concept and takes full responsibility for take-back obligations and disposal obligations for manufacturers within the EU. Contact your Rohde & Schwarz customer service center for environmentally responsible disposal of the product.
3. If products or their components are mechanically and/or thermally processed in a manner that goes beyond their intended use, hazardous substances (heavy-metal dust such as lead, beryllium, nickel) may be released. For this reason, the product may only be disassembled by specially trained personnel. Improper disassembly may be hazardous to your health. National waste disposal regulations must be observed.
4. If handling the product releases hazardous substances or fuels that must be disposed of in a special way, e.g. coolants or engine oils that must be replenished regularly, the safety instructions of the manufacturer of the hazardous substances or fuels and the applicable regional waste disposal regulations must be observed. Also observe the relevant safety instructions in the product documentation. The improper disposal of hazardous substances or fuels can cause health problems and lead to environmental damage.

For additional information about environmental protection, visit the Rohde & Schwarz website.

Instrucciones de seguridad elementales

¡Es imprescindible leer y cumplir las siguientes instrucciones e informaciones de seguridad!

El principio del grupo de empresas Rohde & Schwarz consiste en tener nuestros productos siempre al día con los estándares de seguridad y de ofrecer a nuestros clientes el máximo grado de seguridad. Nuestros productos y todos los equipos adicionales son siempre fabricados y examinados según las normas de seguridad vigentes. Nuestro sistema de garantía de calidad controla constantemente que sean cumplidas estas normas. El presente producto ha sido fabricado y examinado según el certificado de conformidad adjunto de la UE y ha salido de nuestra planta en estado impecable según los estándares técnicos de seguridad. Para poder preservar este estado y garantizar un funcionamiento libre de peligros, el usuario deberá atenerse a todas las indicaciones, informaciones de seguridad y notas de alerta. El grupo de empresas Rohde & Schwarz está siempre a su disposición en caso de que tengan preguntas referentes a estas informaciones de seguridad.













Además queda en la responsabilidad del usuario utilizar el producto en la forma debida. Este producto está destinado exclusivamente al uso en la industria y el laboratorio o, si ha sido expresamente autorizado, para aplicaciones de campo y de ninguna manera deberá ser utilizado de modo que alguna persona/cosa pueda sufrir daño. El uso del producto fuera de sus fines definidos o sin tener en cuenta las instrucciones del fabricante queda en la responsabilidad del usuario. El fabricante no se hace en ninguna forma responsable de consecuencias a causa del mal uso del producto.

Instrucciones de seguridad elementales



Se parte del uso correcto del producto para los fines definidos si el producto es utilizado conforme a las indicaciones de la correspondiente documentación del producto y dentro del margen de rendimiento definido (ver hoja de datos, documentación, informaciones de seguridad que siguen). El uso del producto hace necesarios conocimientos técnicos y ciertos conocimientos del idioma inglés. Por eso se debe tener en cuenta que el producto solo pueda ser operado por personal especializado o personas instruidas en profundidad con las capacidades correspondientes. Si fuera necesaria indumentaria de seguridad para el uso de productos de Rohde & Schwarz, encontraría la información debida en la documentación del producto en el capítulo correspondiente. Guarde bien las informaciones de seguridad elementales, así como la documentación del producto, y entréguelas a usuarios posteriores.

Tener en cuenta las informaciones de seguridad sirve para evitar en lo posible lesiones o daños por peligros de toda clase. Por eso es imprescindible leer detalladamente y comprender por completo las siguientes informaciones de seguridad antes de usar el producto, y respetarlas durante el uso del producto. Deberán tenerse en cuenta todas las demás informaciones de seguridad, como p. ej. las referentes a la protección de personas, que encontrarán en el capítulo correspondiente de la documentación del producto y que también son de obligado cumplimiento. En las presentes informaciones de seguridad se recogen todos los objetos que distribuye el grupo de empresas Rohde & Schwarz bajo la denominación de "producto", entre ellos también aparatos, instalaciones así como toda clase de accesorios. Los datos específicos del producto figuran en la hoja de datos y en la documentación del producto.

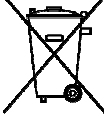
Símbolos y definiciones de seguridad

Símbolo	Significado	Símbolo	Significado
	Aviso: punto de peligro general Observar la documentación del producto		Tensión de alimentación de PUESTA EN MARCHA / PARADA
	Atención en el manejo de dispositivos de peso elevado		Indicación de estado de espera (standby)
	Peligro de choque eléctrico		Corriente continua (DC)
	Advertencia: superficie caliente		Corriente alterna (AC)
	Conexión a conductor de protección		Corriente continua / Corriente alterna (DC/AC)
	Conexión a tierra		El aparato está protegido en su totalidad por un aislamiento doble (reforzado)
	Conexión a masa		Distintivo de la UE para baterías y acumuladores Más información en la sección "Eliminación/protección del medio ambiente", punto 1.

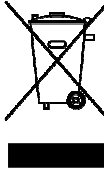
Instrucciones de seguridad elementales

Símbolo	Significado	Símbolo	Significado
	Aviso: Cuidado en el manejo de dispositivos sensibles a la electrostática (ESD)		Distintivo de la UE para la eliminación por separado de dispositivos eléctricos y electrónicos Más información en la sección "Eliminación/protección del medio ambiente", punto 2.
	Advertencia: rayo láser Más información en la sección "Funcionamiento", punto 7.		

Palabras de señal y su significado

En la documentación del producto se utilizan las siguientes palabras de señal con el fin de advertir contra riesgos y peligros.



PELIGRO identifica un peligro inminente con riesgo elevado que provocará muerte o lesiones graves si no se evita.



ADVERTENCIA identifica un posible peligro con riesgo medio de provocar muerte o lesiones (graves) si no se evita.



ATENCIÓN identifica un peligro con riesgo reducido de provocar lesiones leves o moderadas si no se evita.



AVISO indica la posibilidad de utilizar mal el producto y, como consecuencia, dañarlo.
En la documentación del producto se emplea de forma sinónima el término CUIDADO.

Las palabras de señal corresponden a la definición habitual para aplicaciones civiles en el área económica europea. Pueden existir definiciones diferentes a esta definición en otras áreas económicas o en aplicaciones militares. Por eso se deberá tener en cuenta que las palabras de señal aquí descritas sean utilizadas siempre solamente en combinación con la correspondiente documentación del producto y solamente en combinación con el producto correspondiente. La utilización de las palabras de señal en combinación con productos o documentaciones que no les correspondan puede llevar a interpretaciones equivocadas y tener por consecuencia daños en personas u objetos.

Estados operativos y posiciones de funcionamiento

El producto solamente debe ser utilizado según lo indicado por el fabricante respecto a los estados operativos y posiciones de funcionamiento sin que se obstruya la ventilación. Si no se siguen las indicaciones del fabricante, pueden producirse choques eléctricos, incendios y/o lesiones graves con posible consecuencia de muerte. En todos los trabajos deberán ser tenidas en cuenta las normas nacionales y locales de seguridad del trabajo y de prevención de accidentes.

Instrucciones de seguridad elementales

1. Si no se convino de otra manera, es para los productos Rohde & Schwarz válido lo que sigue: como posición de funcionamiento se define por principio la posición con el suelo de la caja para abajo, modo de protección IP 2X, uso solamente en estancias interiores, utilización hasta 2000 m sobre el nivel del mar, transporte hasta 4500 m sobre el nivel del mar. Se aplicará una tolerancia de $\pm 10\%$ sobre el voltaje nominal y de $\pm 5\%$ sobre la frecuencia nominal. Categoría de sobrecarga eléctrica 2, índice de suciedad 2.
2. No sitúe el producto encima de superficies, vehículos, estantes o mesas, que por sus características de peso o de estabilidad no sean aptos para él. Siga siempre las instrucciones de instalación del fabricante cuando instale y asegure el producto en objetos o estructuras (p. ej. paredes y estantes). Si se realiza la instalación de modo distinto al indicado en la documentación del producto, se pueden causar lesiones o, en determinadas circunstancias, incluso la muerte.
3. No ponga el producto sobre aparatos que generen calor (p. ej. radiadores o calefactores). La temperatura ambiente no debe superar la temperatura máxima especificada en la documentación del producto o en la hoja de datos. En caso de sobrecalentamiento del producto, pueden producirse choques eléctricos, incendios y/o lesiones graves con posible consecuencia de muerte.

Seguridad eléctrica

Si no se siguen (o se siguen de modo insuficiente) las indicaciones del fabricante en cuanto a seguridad eléctrica, pueden producirse choques eléctricos, incendios y/o lesiones graves con posible consecuencia de muerte.

1. Antes de la puesta en marcha del producto se deberá comprobar siempre que la tensión preseleccionada en el producto coincida con la de la red de alimentación eléctrica. Si es necesario modificar el ajuste de tensión, también se deberán cambiar en caso dado los fusibles correspondientes del producto.
2. Los productos de la clase de protección I con alimentación móvil y enchufe individual solamente podrán enchufarse a tomas de corriente con contacto de seguridad y con conductor de protección conectado.
3. Queda prohibida la interrupción intencionada del conductor de protección, tanto en la toma de corriente como en el mismo producto. La interrupción puede tener como consecuencia el riesgo de que el producto sea fuente de choques eléctricos. Si se utilizan cables alargadores o regletas de enchufe, deberá garantizarse la realización de un examen regular de los mismos en cuanto a su estado técnico de seguridad.
4. Si el producto no está equipado con un interruptor para desconectarlo de la red, o bien si el interruptor existente no resulta apropiado para la desconexión de la red, el enchufe del cable de conexión se deberá considerar como un dispositivo de desconexión. El dispositivo de desconexión se debe poder alcanzar fácilmente y debe estar siempre bien accesible. Si, p. ej., el enchufe de conexión a la red es el dispositivo de desconexión, la longitud del cable de conexión no debe superar 3 m). Los interruptores selectores o electrónicos no son aptos para el corte de la red eléctrica. Si se integran productos sin interruptor en bastidores o instalaciones, se deberá colocar el interruptor en el nivel de la instalación.
5. No utilice nunca el producto si está dañado el cable de conexión a red. Compruebe regularmente el correcto estado de los cables de conexión a red. Asegúrese, mediante las medidas de protección y de instalación adecuadas, de que el cable de conexión a red no pueda ser dañado o de que nadie pueda ser dañado por él, p. ej. al tropezar o por un choque eléctrico.

Instrucciones de seguridad elementales

6. Solamente está permitido el funcionamiento en redes de alimentación TN/TT aseguradas con fusibles de 16 A como máximo (utilización de fusibles de mayor amperaje solo previa consulta con el grupo de empresas Rohde & Schwarz).
7. Nunca conecte el enchufe en tomas de corriente sucias o llenas de polvo. Introduzca el enchufe por completo y fuertemente en la toma de corriente. La no observación de estas medidas puede provocar chispas, fuego y/o lesiones.
8. No sobrecargue las tomas de corriente, los cables alargadores o las regletas de enchufe ya que esto podría causar fuego o choques eléctricos.
9. En las mediciones en circuitos de corriente con una tensión $U_{\text{eff}} > 30 \text{ V}$ se deberán tomar las medidas apropiadas para impedir cualquier peligro (p. ej. medios de medición adecuados, seguros, limitación de tensión, corte protector, aislamiento etc.).
10. Para la conexión con dispositivos informáticos como un PC o un ordenador industrial, debe comprobarse que éstos cumplan los estándares IEC60950-1/EN60950-1 o IEC61010-1/EN 61010-1 válidos en cada caso.
11. A menos que esté permitido expresamente, no retire nunca la tapa ni componentes de la carcasa mientras el producto esté en servicio. Esto pone a descubierto los cables y componentes eléctricos y puede causar lesiones, fuego o daños en el producto.
12. Si un producto se instala en un lugar fijo, se deberá primero conectar el conductor de protección fijo con el conductor de protección del producto antes de hacer cualquier otra conexión. La instalación y la conexión deberán ser efectuadas por un electricista especializado.
13. En el caso de dispositivos fijos que no estén provistos de fusibles, interruptor automático ni otros mecanismos de seguridad similares, el circuito de alimentación debe estar protegido de modo que todas las personas que puedan acceder al producto, así como el producto mismo, estén a salvo de posibles daños.
14. Todo producto debe estar protegido contra sobretensión (debida p. ej. a una caída del rayo) mediante los correspondientes sistemas de protección. Si no, el personal que lo utilice quedará expuesto al peligro de choque eléctrico.
15. No debe introducirse en los orificios de la caja del aparato ningún objeto que no esté destinado a ello. Esto puede producir cortocircuitos en el producto y/o puede causar choques eléctricos, fuego o lesiones.
16. Salvo indicación contraria, los productos no están impermeabilizados (ver también el capítulo "Estados operativos y posiciones de funcionamiento", punto 1). Por eso es necesario tomar las medidas necesarias para evitar la entrada de líquidos. En caso contrario, existe peligro de choque eléctrico para el usuario o de daños en el producto, que también pueden redundar en peligro para las personas.
17. No utilice el producto en condiciones en las que pueda producirse o ya se hayan producido condensaciones sobre el producto o en el interior de éste, como p. ej. al desplazarlo de un lugar frío a otro caliente. La entrada de agua aumenta el riesgo de choque eléctrico.
18. Antes de la limpieza, desconecte por completo el producto de la alimentación de tensión (p. ej. red de alimentación o batería). Realice la limpieza de los aparatos con un paño suave, que no se deshilache. No utilice bajo ningún concepto productos de limpieza químicos como alcohol, acetona o diluyentes para lacas nitrocelulósicas.

Instrucciones de seguridad elementales

Funcionamiento

1. El uso del producto requiere instrucciones especiales y una alta concentración durante el manejo. Debe asegurarse que las personas que manejen el producto estén a la altura de los requerimientos necesarios en cuanto a aptitudes físicas, psíquicas y emocionales, ya que de otra manera no se pueden excluir lesiones o daños de objetos. El empresario u operador es responsable de seleccionar el personal usuario apto para el manejo del producto.
2. Antes de desplazar o transportar el producto, lea y tenga en cuenta el capítulo "Transporte".
3. Como con todo producto de fabricación industrial no puede quedar excluida en general la posibilidad de que se produzcan alergias provocadas por algunos materiales empleados —los llamados alérgenos (p. ej. el níquel)—. Si durante el manejo de productos Rohde & Schwarz se producen reacciones alérgicas, como p. ej. irritaciones cutáneas, estornudos continuos, enrojecimiento de la conjuntiva o dificultades respiratorias, debe avisarse inmediatamente a un médico para investigar las causas y evitar cualquier molestia o daño a la salud.
4. Antes de la manipulación mecánica y/o térmica o el desmontaje del producto, debe tenerse en cuenta imprescindiblemente el capítulo "Eliminación/protección del medio ambiente", punto 1.
5. Ciertos productos, como p. ej. las instalaciones de radiocomunicación RF, pueden a causa de su función natural, emitir una radiación electromagnética aumentada. Deben tomarse todas las medidas necesarias para la protección de las mujeres embarazadas. También las personas con marcapasos pueden correr peligro a causa de la radiación electromagnética. El empresario/operador tiene la obligación de evaluar y señalizar las áreas de trabajo en las que exista un riesgo elevado de exposición a radiaciones.
6. Tenga en cuenta que en caso de incendio pueden desprenderse del producto sustancias tóxicas (gases, líquidos etc.) que pueden generar daños a la salud. Por eso, en caso de incendio deben usarse medidas adecuadas, como p. ej. máscaras antigás e indumentaria de protección.
7. Los productos con láser están provistos de indicaciones de advertencia normalizadas en función de la clase de láser del que se trate. Los rayos láser pueden provocar daños de tipo biológico a causa de las propiedades de su radiación y debido a su concentración extrema de potencia electromagnética. En caso de que un producto Rohde & Schwarz contenga un producto láser (p. ej. un lector de CD/DVD), no debe usarse ninguna otra configuración o función aparte de las descritas en la documentación del producto, a fin de evitar lesiones (p. ej. debidas a irradiación láser).
8. Clases CEM (según CISPR 11)
Clase A: dispositivo apropiado para el uso en cualquier zona excepto en áreas residenciales y en aquellas zonas que se encuentran conectadas a una red de suministro de baja tensión que alimenta un edificio de viviendas.
Clase B: dispositivo apropiado para el uso en áreas residenciales y en aquellas zonas que se encuentran conectadas a una red de suministro de baja tensión que alimenta un edificio de viviendas.

Reparación y mantenimiento

1. El producto solamente debe ser abierto por personal especializado con autorización para ello. Antes de manipular el producto o abrirlo, es obligatorio desconectarlo de la tensión de alimentación, para evitar toda posibilidad de choque eléctrico.

Instrucciones de seguridad elementales

2. El ajuste, el cambio de partes, el mantenimiento y la reparación deberán ser efectuadas solamente por electricistas autorizados por Rohde & Schwarz. Si se reponen partes con importancia para los aspectos de seguridad (p. ej. el enchufe, los transformadores o los fusibles), solamente podrán ser sustituidos por partes originales. Después de cada cambio de partes relevantes para la seguridad deberá realizarse un control de seguridad (control a primera vista, control del conductor de protección, medición de resistencia de aislamiento, medición de la corriente de fuga, control de funcionamiento). Con esto queda garantizada la seguridad del producto.

Baterías y acumuladores o celdas

Si no se siguen (o se siguen de modo insuficiente) las indicaciones en cuanto a las baterías y acumuladores o celdas, pueden producirse explosiones, incendios y/o lesiones graves con posible consecuencia de muerte. El manejo de baterías y acumuladores con electrolitos alcalinos (p. ej. celdas de litio) debe seguir el estándar EN 62133.

1. No deben desmontarse, abrirse ni triturarse las celdas.
2. Las celdas o baterías no deben someterse a calor ni fuego. Debe evitarse el almacenamiento a la luz directa del sol. Las celdas y baterías deben mantenerse limpias y secas. Limpiar las conexiones sucias con un paño seco y limpio.
3. Las celdas o baterías no deben cortocircuitarse. Es peligroso almacenar las celdas o baterías en estuches o cajones en cuyo interior puedan cortocircuitarse por contacto recíproco o por contacto con otros materiales conductores. No deben extraerse las celdas o baterías de sus embalajes originales hasta el momento en que vayan a utilizarse.
4. Las celdas o baterías no deben someterse a impactos mecánicos fuertes indebidos.
5. En caso de falta de estanqueidad de una celda, el líquido vertido no debe entrar en contacto con la piel ni los ojos. Si se produce contacto, lavar con agua abundante la zona afectada y avisar a un médico.
6. En caso de cambio o recarga inadecuados, las celdas o baterías que contienen electrolitos alcalinos (p. ej. las celdas de litio) pueden explotar. Para garantizar la seguridad del producto, las celdas o baterías solo deben ser sustituidas por el tipo Rohde & Schwarz correspondiente (ver lista de recambios).
7. Las baterías y celdas deben reciclarse y no deben tirarse a la basura doméstica. Las baterías o acumuladores que contienen plomo, mercurio o cadmio deben tratarse como residuos especiales. Respete en esta relación las normas nacionales de eliminación y reciclaje.

Transporte

1. El producto puede tener un peso elevado. Por eso es necesario desplazarlo o transportarlo con precaución y, si es necesario, usando un sistema de elevación adecuado (p. ej. una carretilla elevadora), a fin de evitar lesiones en la espalda u otros daños personales.
2. Las asas instaladas en los productos sirven solamente de ayuda para el transporte del producto por personas. Por eso no está permitido utilizar las asas para la sujeción en o sobre medios de transporte como p. ej. grúas, carretillas elevadoras de horquilla, carros etc. Es responsabilidad suya fijar los productos de manera segura a los medios de transporte o elevación. Para evitar daños personales o daños en el producto, siga las instrucciones de seguridad del fabricante del medio de transporte o elevación utilizado.

Instrucciones de seguridad elementales

3. Si se utiliza el producto dentro de un vehículo, recae de manera exclusiva en el conductor la responsabilidad de conducir el vehículo de manera segura y adecuada. El fabricante no asumirá ninguna responsabilidad por accidentes o colisiones. No utilice nunca el producto dentro de un vehículo en movimiento si esto pudiera distraer al conductor. Asegure el producto dentro del vehículo debidamente para evitar, en caso de un accidente, lesiones u otra clase de daños.

Eliminación/protección del medio ambiente

1. Los dispositivos marcados contienen una batería o un acumulador que no se debe desechar con los residuos domésticos sin clasificar, sino que debe ser recogido por separado. La eliminación se debe efectuar exclusivamente a través de un punto de recogida apropiado o del servicio de atención al cliente de Rohde & Schwarz.
2. Los dispositivos eléctricos usados no se deben desechar con los residuos domésticos sin clasificar, sino que deben ser recogidos por separado.
Rohde & Schwarz GmbH & Co.KG ha elaborado un concepto de eliminación de residuos y asume plenamente los deberes de recogida y eliminación para los fabricantes dentro de la UE. Para desechar el producto de manera respetuosa con el medio ambiente, diríjase a su servicio de atención al cliente de Rohde & Schwarz.
3. Si se trabaja de manera mecánica y/o térmica cualquier producto o componente más allá del funcionamiento previsto, pueden liberarse sustancias peligrosas (p. ej. plomo, berilio o níquel). Por eso el producto solo debe ser desmontado por personal especializado con formación adecuada. Un desmontaje inadecuado puede ocasionar daños para la salud. Se deben tener en cuenta las directivas nacionales referentes a la eliminación de residuos.
4. En caso de que durante el trato del producto se formen sustancias peligrosas o combustibles que deban tratarse como residuos especiales (p. ej. refrigerantes o aceites de motor con intervalos de cambio definidos), deben tenerse en cuenta las indicaciones de seguridad del fabricante de dichas sustancias y las normas regionales de eliminación de residuos. Tenga en cuenta también en caso necesario las indicaciones de seguridad especiales contenidas en la documentación del producto. La eliminación incorrecta de sustancias peligrosas o combustibles puede causar daños a la salud o daños al medio ambiente.

Se puede encontrar más información sobre la protección del medio ambiente en la página web de Rohde & Schwarz.

Qualitätszertifikat

Certificate of quality

Certificat de qualité

Certified Quality System
ISO 9001

Certified Environmental System
ISO 14001

Sehr geehrter Kunde,

Sie haben sich für den Kauf eines Rohde&Schwarz-Produktes entschieden. Sie erhalten damit ein nach modernsten Fertigungsmethoden hergestelltes Produkt. Es wurde nach den Regeln unseres Qualitätsmanagementsystems entwickelt, gefertigt und geprüft. Das Rohde&Schwarz-Qualitätsmanagementsystem ist unter anderem nach ISO9001 und ISO14001 zertifiziert.

Der Umwelt verpflichtet

- Energie-effiziente, RoHS-konforme Produkte
- Kontinuierliche Weiterentwicklung nachhaltiger Umweltkonzepte
- ISO14001-zertifiziertes Umweltmanagementsystem

Dear customer,

You have decided to buy a Rohde&Schwarz product. You are thus assured of receiving a product that is manufactured using the most modern methods available. This product was developed, manufactured and tested in compliance with our quality management system standards. The Rohde&Schwarz quality management system is certified according to standards such as ISO9001 and ISO14001.

Environmental commitment

- Energy-efficient products
- Continuous improvement in environmental sustainability
- ISO14001-certified environmental management system

Cher client,

Vous avez choisi d'acheter un produit Rohde&Schwarz. Vous disposez donc d'un produit fabriqué d'après les méthodes les plus avancées. Le développement, la fabrication et les tests respectent nos normes de gestion qualité. Le système de gestion qualité de Rohde&Schwarz a été homologué, entre autres, conformément aux normes ISO9001 et ISO14001.

Engagement écologique

- Produits à efficience énergétique
- Amélioration continue de la durabilité environnementale
- Système de gestion de l'environnement certifié selon ISO14001





ROHDE & SCHWARZ

CE Declaration of Conformity



Certificate No.: 2010-5

This is to certify that:

Equipment type	Stock No.	Designation
SMA100A	1400.0000.02	SIGNAL GENERATOR

complies with the provisions of the Directive of the Council of the European Union on the approximation of the laws of the Member States

- relating to electrical equipment for use within defined voltage limits (2006/95/EC)
- relating to electromagnetic compatibility (2004/108/EC)

Conformity is proven by compliance with the following standards:

EN 61010-1: 2001
EN 61326-1: 2006
EN 61326-2-1: 2006
EN 55011: 2007 + A2: 2007
EN 61000-3-2: 2006
EN 61000-3-3: 1995 + A1: 2001 + A2: 2005

For the assessment of electromagnetic compatibility, the limits of radio interference for Class B equipment as well as the immunity to interference for operation in industry have been used as a basis.

ROHDE & SCHWARZ GmbH & Co. KG
Mühldorfstr. 15, D-81671 München

Munich, 2009-02-05

Central Quality Management MF-QZ / Radde

CE

E-1

Customer Support

Technical support – where and when you need it

For quick, expert help with any Rohde & Schwarz equipment, contact one of our Customer Support Centers. A team of highly qualified engineers provides telephone support and will work with you to find a solution to your query on any aspect of the operation, programming or applications of Rohde & Schwarz equipment.

Up-to-date information and upgrades

To keep your instrument up-to-date and to be informed about new application notes related to your instrument, please send an e-mail to the Customer Support Center stating your instrument and your wish. We will take care that you will get the right information.

Europe, Africa, Middle East

Phone +49 89 4129 12345
customersupport@rohde-schwarz.com

North America

Phone 1-888-TEST-RSA (1-888-837-8772)
customer.support@rsa.rohde-schwarz.com

Latin America

Phone +1-410-910-7988
customersupport.la@rohde-schwarz.com

Asia/Pacific

Phone +65 65 13 04 88
customersupport.asia@rohde-schwarz.com

China

Phone +86-800-810-8228 /
+86-400-650-5896
customersupport.china@rohde-schwarz.com



Contents

1	Preface	13
1.1	Documentation Overview.....	13
1.2	Typographical Conventions.....	14
2	Preparing for Use	15
2.1	Front Panel Tour.....	15
2.1.1	Utility Keys.....	16
2.1.2	Standby LEDs and Standby Key.....	16
2.1.3	Display.....	16
2.1.4	Setup Keys.....	17
2.1.4.1	Keys for Setting Paramters.....	17
2.1.4.2	Display Keys.....	18
2.1.5	Keypad for data entry.....	18
2.1.6	Rotary Knob and Navigation Keys.....	19
2.1.7	Front Panel Connectors.....	20
2.2	Rear Panel Tour.....	21
2.2.1	Description of the Connectors.....	22
2.3	Putting into Operation.....	24
2.3.1	Unpacking and Checking the Instrument.....	26
2.3.2	Placing or Mounting the Instrument.....	26
2.3.3	Connecting the Instrument to the AC Supply.....	27
2.3.4	Starting the Instrument.....	28
2.3.4.1	Standby and Ready state.....	28
2.3.4.2	Start Display and Booting.....	28
2.3.4.3	Function Check.....	29
2.3.4.4	Default Settings.....	29
2.3.5	Shutting Down the Instrument.....	30
2.3.6	Power Fuses.....	31
2.4	Connecting External Accessories.....	31
2.4.1	Connecting USB Devices.....	31
2.5	Linux Operating System.....	32
2.6	Setting Up a Network (LAN) Connection.....	34

2.6.1	Connecting the Instrument to the Network.....	34
2.6.2	Assigning the IP Address.....	35
2.6.3	Using Computer Names.....	36
2.7	Remote Access via an External Controller.....	37
2.7.1	Using a Web Browser for Remote Access.....	38
2.7.2	Remote Access via Ultr@VNC.....	39
3	Getting Started.....	44
3.1	Brief Introduction to the Instrument's Concept.....	44
3.2	Application Field of the Instrument.....	46
3.3	Description of Individual Diagram Blocks.....	46
3.4	Example of Setup.....	48
4	Manual Operation.....	54
4.1	Key Features.....	54
4.2	Display.....	57
4.2.1	Settings Displayed in the Header Section.....	57
4.2.2	Status Information and Messages.....	58
4.2.2.1	Status Information.....	58
4.2.2.2	Messages.....	58
4.2.2.3	Volatile messages.....	59
4.2.2.4	Permanent Messages.....	59
4.2.3	Info Window.....	59
4.2.4	Block Diagram	60
4.2.4.1	Function Blocks in the Block Diagram.....	60
4.2.4.2	Signal Flow and Input/Output Symbols in the Block Diagram.....	61
4.2.5	Structure of the Dialogs.....	61
4.3	Accessing Dialogs.....	62
4.4	Setting Parameters.....	63
4.4.1	Working with the Cursor.....	64
4.4.2	Selecting a Control Element.....	64
4.4.3	Switching Parameters On/Off.....	65
4.4.4	Entering a Value.....	65
4.4.5	Working with Units	66
4.4.6	Selecting a Value from a List.....	67

4.4.7	Terminating Entries with Confirmation.....	68
4.4.8	Restoring the Previous Value.....	68
4.5	Editors.....	69
4.5.1	Working with List Editor.....	69
4.6	How to Use the Help System.....	71
4.7	File Management.....	72
4.7.1	File Select Dialog.....	73
4.7.2	File Manager.....	74
4.7.2.1	Extensions for User Files.....	75
4.8	Legend of Front-Panel Controls.....	76
4.8.1	Front Panel Key Emulation.....	77
5	Instrument Function.....	79
5.1	Overview of Instrument Functions.....	79
5.2	General Instrument Settings.....	81
5.2.1	Overview of General Instrument Settings.....	81
5.2.2	Default Instrument Settings - Preset Key.....	81
5.2.3	General Configuration of Instrument - Setup Key.....	82
5.2.3.1	Internal Adjustments.....	82
5.2.3.2	Hardware Config.....	84
5.2.3.3	Software / Options.....	85
5.2.3.4	Manage License Keys.....	87
5.2.3.5	Gui Update.....	88
5.2.3.6	NRP-Z Info/Update.....	88
5.2.3.7	Update.....	89
5.2.3.8	Selftest.....	90
5.2.3.9	Check Front Panel.....	90
5.2.3.10	Date and Time	90
5.2.3.11	Network Settings	91
5.2.3.12	Display/Keyboard Settings.....	93
5.2.3.13	Remote Channel Settings.....	94
5.2.3.14	Protection.....	97
5.2.3.15	Security.....	98
5.2.3.16	Save/Recall.....	102

5.2.3.17	Factory Preset.....	102
5.2.3.18	Help.....	103
5.2.4	Switching to Manual Control - Local Key.....	103
5.2.5	Generating a Hard Copy of the Display.....	104
5.2.5.1	Hardcopy Dialog.....	104
5.2.5.2	Hardcopy Options.....	105
5.2.6	Messages - Info Key.....	107
5.2.7	Help System - Help Key.....	107
5.2.8	Storing and Loading Instrument Data - File Key.....	108
5.2.8.1	File Menu.....	109
5.2.8.2	Storing Instrument Settings.....	109
5.2.8.3	Loading Instrument Settings.....	110
5.2.8.4	File Manager.....	112
5.3	RF Block.....	114
5.3.1	Overview of RF Signal.....	114
5.3.1.1	RF Output.....	114
5.3.1.2	RF Signal Modes and Characteristics.....	115
5.3.2	RF Frequency.....	115
5.3.2.1	RF Frequency vs. RF Output Frequency.....	116
5.3.2.2	Setting the RF Frequency.....	116
5.3.2.3	RF Frequency Dialog.....	117
5.3.3	Phase.....	118
5.3.3.1	Phase Settings.....	119
5.3.3.2	Phase Continuous Frequency Setting.....	119
5.3.4	Reference Oscillator.....	124
5.3.4.1	Reference Oscillator Dialog.....	124
5.3.5	RF Level.....	127
5.3.5.1	Overview of RF Level.....	127
5.3.5.2	RF Level Dialog.....	128
5.3.5.3	Power-On/EMF Settings.....	132
5.3.5.4	Automatic Level Control - ALC.....	132
5.3.5.5	NRP-Z Level Control.....	134
5.3.5.6	User Correction.....	138

5.3.6	RF Measurement.....	145
5.3.6.1	Power Sensors.....	145
5.3.6.2	NRP-Z Power Viewer.....	145
5.3.6.3	NRP-Z Power Analysis.....	151
5.3.7	RF Sweep and List Mode.....	189
5.3.7.1	Overview.....	189
5.3.7.2	RF Frequency Sweep.....	190
5.3.7.3	RF Level Sweep.....	196
5.3.7.4	List Mode.....	202
5.4	Modulation.....	213
5.4.1	Overview of Modulation.....	213
5.4.1.1	Enabling/Disabling Analog Modulations using the MOD On/Off Key.....	213
5.4.1.2	Modulation Sources.....	214
5.4.2	Amplitude Modulation (AM).....	215
5.4.2.1	Amplitude Modulation Settings.....	215
5.4.2.2	Noise Settings.....	218
5.4.3	Frequency Modulation (FM).....	218
5.4.3.1	Frequency Modulation Settings.....	218
5.4.3.2	Noise Settings.....	223
5.4.4	Phase Modulation (PhiM).....	223
5.4.4.1	Phase Modulation Menu.....	224
5.4.4.2	Noise Settings.....	228
5.4.5	Pulse Modulation (PM).....	229
5.4.5.1	Pulse Modulation Settings.....	229
5.4.6	Chirp Modulation.....	231
5.4.6.1	Chirp Modulation Settings.....	233
5.4.7	DME Modulation.....	236
5.4.7.1	DME Modulation Settings.....	237
5.4.7.2	Trigger Settings for DME.....	246
5.4.7.3	ID Settings for DME Reply Mode.....	248
5.4.7.4	DME Composite AM.....	251
5.4.7.5	DME Analysis.....	253
5.4.8	VOR Modulation.....	258

5.4.8.1	VOR Modulation Settings.....	259
5.4.9	ILS-GS Modulation.....	266
5.4.9.1	ILS-GS Modulation Settings.....	266
5.4.10	ILS-LOC Modulation.....	272
5.4.10.1	ILS-Localizer Modulation Settings.....	273
5.4.11	Marker Beacon Modulation.....	282
5.4.11.1	Marker Beacon Modulation Menu.....	282
5.4.12	ADF Modulation.....	287
5.4.12.1	ADF Modulation Menu.....	288
5.5	Modulation Generator and LF Output.....	291
5.5.1	Overview of LF Generator.....	291
5.5.2	LF Frequency Sweep.....	292
5.5.3	LF Output.....	297
5.5.3.1	LF Output Dialog.....	298
5.5.3.2	Noise Settings.....	300
5.5.4	Pulse Generator.....	301
5.5.4.1	Pulse Generator Settings.....	302
5.5.4.2	Pulse Train Generation.....	307
5.6	Clock Synthesis.....	311
5.6.1	Clock Synthesis Dialog.....	311
5.6.1.1	Clock Synthesis general Settings.....	312
5.6.1.2	DC Offset.....	312
5.6.1.3	User Variation	313
6	Remote Control Basics.....	314
6.1	Remote Control Interfaces and Protocols.....	314
6.1.1	VISA Libraries.....	315
6.1.2	Messages.....	315
6.1.3	LAN Interface.....	316
6.1.3.1	HiSLIP Protocol.....	317
6.1.3.2	VXI-11 Protocol.....	318
6.1.3.3	Socket Communication.....	318
6.1.3.4	LAN Interface Messages.....	318
6.1.4	USB Interface.....	319

6.1.5	Serial Interface.....	319
6.1.6	GPIB Interface (IEC/IEEE Bus Interface).....	320
6.1.6.1	GPIB Interface Messages.....	320
6.1.6.2	GPIB Instrument Address.....	321
6.2	Starting a Remote Control Session.....	322
6.2.1	Switching to Remote Control.....	322
6.2.2	Returning to Manual Operation.....	323
6.2.3	Examples.....	323
6.2.3.1	Remote Control over GPIB.....	323
6.2.3.2	Remote Control over LAN using VXI-11 Protocol.....	324
6.2.3.3	Remote Control over LAN using Socket Communication.....	328
6.3	SCPI Command Structure.....	334
6.3.1	Syntax for Common Commands.....	334
6.3.2	Syntax for Device-Specific Commands.....	335
6.3.3	SCPI Parameters.....	337
6.3.4	Overview of Syntax Elements.....	340
6.3.5	Structure of a command line.....	340
6.3.6	Responses to Queries.....	341
6.4	Command Sequence and Synchronization.....	342
6.4.1	Preventing Overlapping Execution.....	343
6.5	Status Reporting System.....	345
6.5.1	Hierarchy of status registers.....	345
6.5.2	Structure of a SCPI Status Register.....	346
6.5.3	Contents of the Status Registers.....	348
6.5.3.1	Status Byte (STB) and Service Request Enable Register (SRE).....	348
6.5.3.2	IST Flag and Parallel Poll Enable Register (PPE).....	348
6.5.4	Event Status Register (ESR) and Event Status Enable Register (ESE).....	349
6.5.5	Application of the Status Reporting System.....	349
6.5.5.1	Service Request.....	350
6.5.5.2	Serial Poll.....	350
6.5.5.3	Parallel Poll.....	350
6.5.5.4	Query of an instrument status.....	351
6.5.5.5	Error Queue.....	351

6.5.6	Reset Values of the Status Reporting System.....	351
6.6	General Programming Recommendations.....	352
7	Remote Control Commands.....	354
7.1	Common Commands.....	354
7.2	Preset Commands.....	358
7.3	CALibration Subsystem.....	360
7.4	CSYNthesis Subsystem.....	363
7.5	DIAGnostic Subsystem.....	366
7.6	DISPlay Subsystem.....	367
7.7	FORMat Subsystem.....	370
7.8	HCOPy Subsystem.....	371
7.9	KBOard Subsystem.....	378
7.10	MMEMory Subsystem.....	379
7.10.1	File Naming Conventions.....	380
7.10.2	Extensions for User Files.....	380
7.10.3	Examples.....	381
7.10.4	Remote Control Commands.....	382
7.11	OUTPut Subsystem.....	388
7.12	Power Sensor Measurement Subsystems.....	391
7.12.1	CALCulate Subsystem.....	392
7.12.2	DISPlay Subsystem.....	396
7.12.3	INITiate Command.....	397
7.12.4	READ Subsystem.....	397
7.12.5	SENSE Subsystem.....	398
7.12.6	TRACe Subsystem.....	438
7.13	SOURce Subsystem.....	448
7.13.1	SOURce:ADF Subsystem.....	449
7.13.2	SOURce:AM Subsystem.....	454
7.13.3	SOURce:CHIRp Subsystem.....	457
7.13.4	SOURce:CORRection Subsystem.....	461
7.13.5	SOURce:DME Subsystem.....	470
7.13.6	SOURce:FM Subsystem.....	496
7.13.7	SOURce:FREQuency Subsystem.....	500

7.13.8	SOURce:ILS Subsystem.....	509
7.13.9	SOURce:INPut Subsystem.....	524
7.13.10	SOURce:LFOutput Subsystem.....	525
7.13.11	SOURce:LIST Subsystem.....	537
7.13.12	SOURce:MBEacon Subsystem.....	551
7.13.13	SOURce:MODulation Subsystem.....	557
7.13.14	SOURce:NOISe Subsystem.....	558
7.13.15	SOURce:PGEN Subsystem.....	560
7.13.16	SOURce:PHASe Subsystem.....	560
7.13.17	SOURce:PM Subsystem.....	561
7.13.18	SOURce:POWer Subsystem.....	566
7.13.19	SOURce:PULM Subsystem.....	576
7.13.20	SOURce:ROSCillator Subsystem.....	592
7.13.21	SOURce:SWEep Subsystem.....	595
7.13.22	SOURce:VOR Subsystem.....	604
7.14	STATus Subsystem.....	615
7.15	SYSTem Subsystem.....	619
7.16	TEST Subsystem.....	632
7.17	TRIGger Subsystem.....	633
7.18	UNIT Subsystem.....	638
7.19	Remote control emulation of the HP 8662A signal generator for the R&S SMA	639
7.19.1	HP 8662A commands.....	640
7.19.2	Value ranges and error messages.....	645
8	Maintenance.....	646
8.1	Storing and Packing.....	646
9	Error Messages.....	647
9.1	Status Information.....	647
9.1.1	Status information displayed between the frequency and level fields.....	647
9.1.2	Status information displayed to the left of the Info line.....	648
9.1.3	Status information displayed in the Info line.....	649
9.2	Error Messages.....	650
9.2.1	Volatile messages.....	650

9.2.2	Permanent messages.....	650
9.3	SCPI-Error Messages.....	651
9.4	Device-Specific Error Messages.....	651
A	Hardware Interfaces.....	653
A.1	GPIB Bus Interface.....	653
A.2	AUX I/O Connector.....	654
	List of Commands.....	656
	Index.....	671

1 Preface

1.1 Documentation Overview

The user documentation for the R&S SMA consists of the following parts:

- Online Help system on the instrument,
- "Quick Start Guide" printed manual,
- Documentation CD-ROM with:
 - Online help system (*.chm) as a standalone help,
 - Operating Manual,
 - Service Manual,
 - Data sheet and specifications,
 - Links to useful sites on the R&S internet.

Online Help

The Online Help is embedded in the instrument's firmware. It offers quick, context-sensitive access to the complete information needed for operation and programming. The online help contains help on operating the R&S SMA and all available options.

Quick Start Guide

This manual is delivered with the instrument in printed form and in PDF format on the Documentation CD-ROM. It provides the information needed to set up and start working with the instrument. Basic operations and an example of setup are described. The manual includes also general information, e.g., Safety Instructions.

Operating Manual

The Operating Manual is a supplement to the Quick Start Guide. The manual is available in PDF format - in printable form - on the Documentation CD-ROM delivered with the instrument. In the Operating Manual, all instrument functions are described in detail. Furthermore, it provides an introduction to remote control and a complete description of the remote control commands with programming examples. Information on maintenance, instrument interfaces and error messages is also given. The manual can also be ordered in printed form (see ordering information in the data sheet).

Service Manual

This Service Manual is available in PDF format - in printable form - on the Documentation CD-ROM delivered with the instrument. It describes how to check compliance with rated specifications, on instrument function, repair, troubleshooting and fault elimination. It contains all information required for repairing the instrument by the replacement of modules.

This manual can also be ordered in printed form (see ordering information in the data sheet).

Release Notes

The release notes describe new and modified functions, eliminated problems, and last minute changes to the documentation. The corresponding firmware version is indicated on the title page of the release notes. The current release notes are provided in the Internet.

1.2 Typographical Conventions

The following text markers are used throughout this documentation:

Convention	Description
"Graphical user interface elements"	All names of graphical user interface elements on the screen, such as dialog boxes, menus, options, buttons, and softkeys are enclosed by quotation marks.
KEYS	Key names are written in capital letters.
File names, commands, program code	File names, commands, coding samples and screen output are distinguished by their font.
<i>Input</i>	Input to be entered by the user is displayed in italics.
Links	Links that you can click are displayed in blue font.
"References"	References to other parts of the documentation are enclosed by quotation marks.

2 Preparing for Use

The following topics will help you to get familiar with the instrument and perform the first steps:

- [Front Panel Tour](#)
- [Rear Panel Tour](#)
- [Putting into Operation](#)

This section explains the control elements and connectors of the Signal Generator R&S SMA with the aid of the front and rear views and describes how to put the instrument into operation. It also describes the connection of peripherals such as printer, keyboard or mouse. Specifications of interfaces can be found in the data sheet.

The [chapter 3, "Getting Started"](#), on page 44 of this manual provides an overview of the generator functions and introduces the operating concept. Detailed operating instructions and an overview of menus follow in [chapter 4, "Manual Operation"](#), on page 54.

For all reference information concerning manual and remote control of the instrument refer to the online help system or its printed/printable version. A more detailed description of the hardware connectors and interfaces is also part of the help system.

2.1 Front Panel Tour

The front panel of the R&S Signal Generator consists of the VGA display, some utility keys (left side) and the hardkey area with connectors and control interfaces (right side). The subsequent sections provide brief explanations on the controls and connectors, the hardkey area and the front panel.

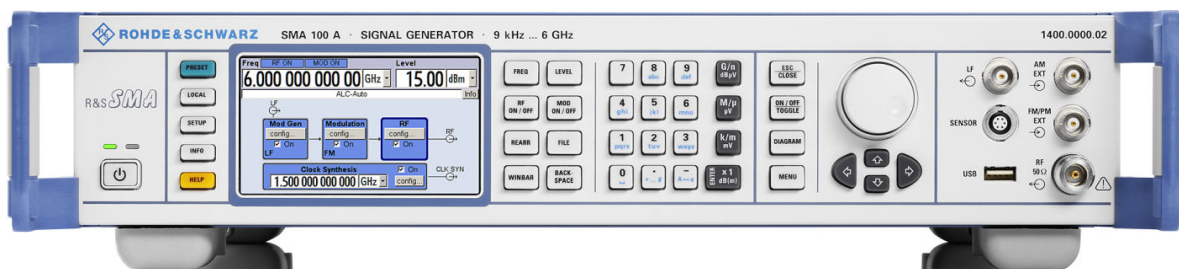

Fig. 2-1: Front panel view

2.1.1 Utility Keys



The keys to the left of the display cause the R&S SMA to return to a definite instrument state and provide information on the instrument and assistance.

For more information refer to chapter "Instrument Settings".

PRESET

Sets the instrument to a defined state (see [chapter 2.3.4.4, "Default Settings"](#), on page 29).

LOCAL

Switches from remote control to local (manual) control.

SETUP

Opens the "Setup" dialog for configuring presettings.

For more information, see [chapter 5.2.3, "General Configuration of Instrument - Setup Key"](#), on page 82.

INFO

Displays status messages, error messages and warnings.

HELP

Displays context-sensitive help text.

2.1.2 Standby LEDs and Standby Key

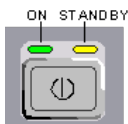

The standby LEDs and the ON/STANDBY key are located in the bottom left corner of the front panel.

The ON/STANDBY key toggles the instrument between standby and ready state (indicated by the standby LEDs).

The standby LEDs indicate the instrument states as follow:

- the green LED (left) is on when the instrument is ready for operation,
- the yellow LED (right) is on in the standby mode.

See also [chapter 2.3.4.1, "Standby and Ready state"](#), on page 28.

2.1.3 Display

The display clearly shows all main settings and signal generator states.

The display is divided into the following sections:

- Frequency and level display with info line

- Frequency and level settings containing offset.
- Status messages
- Brief error messages.
To access an window with detailed information for a message, use the INFO key.
- Block diagram
The block diagram shows the current configuration and the signal flow in the generator with the aid of function blocks containing an on/off switch. Selecting a function block opens a list of associated setting menus. Active menus, info windows and graphs are displayed on top of the block diagram. The block diagram can be displayed in the foreground anytime with the **DIAGRAM** key.

For detailed information, see [chapter 4.2, "Display"](#), on page 57.

2.1.4 Setup Keys

The keys to the right of the display set parameters, select views and control the windows.

2.1.4.1 Keys for Setting Paramters



These keys provide direct access to the settings in the header of the instrument and can be used for fast changing the state of the modulation and the RF signal.

For more information refer to chapter "Instrument Functions".

FREQ

Activates frequency entry.

RF ON/OFF

Switches the RF signal on and off.

"RF OFF" is displayed in the header next to the "Frequency" field.

LEVEL

Activates level entry.

MOD ON/OFF

Switches the modulations on and off.

"MOD OFF" is displayed in the info line of the header next to the "Level" field.

REARR

Adjusts the size of the active menu to use the whole hight of the dislay.

FILE

Activates the menu for storing or loading files (see [chapter 4.7, "File Management"](#), on page 72).

WINBAR

Toggles between the active menus.

BACKSPACE

Deletes the character to the left of the cursor.

2.1.4.2 Display Keys

The keys left of the rotary knob arrange different windows on the display.

**ESC**

The function of this key depends on the current cursor position.

- Calls the next higher selection level.
- Closes the open window without accepting new entries; the old value or parameter is retained.
- In dialog boxes that contain a "Cancel" button it activates that button.
- Closes all kinds of dialog boxes, if the edit mode is not active.
- Quits the edit mode, if the edit mode is active.
- Switches between different entry fields of a menu.
- Shifts the entry cursor from the header display to the previously active menu, or to the previously highlighted block in the block diagram if no menu is active.

TOGGLE

- Switches highlighted elements or a function block on and off.
- Switches between two or more settings, e.g. items of selection lists. At the end of a list, the cursor is set on the first entry again.

DIAGRAM

Brings the block diagram to the foreground. Active menus are minimized.

The display of the header section can be enlarged so that it completely covers the display by pressing the DIAGRAM key twice. The frequency, level and status information is indicated in extra large letters.

MENU

Calls the menu tree.

2.1.5 Keypad for data entry

The keys in the data entry keypad are used to enter alphanumeric data and units.

Data entry keys are only enabled while the cursor is placed on a data input field in a dialog. Their function depends on the data type of the input field.



Keys	Description
0...9/abc	Enters the corresponding numbers (in numeric input fields) or characters (character input fields).
.	Inserts a decimal point (numeric input fields) or dot (character input fields) at the cursor position. Multiple decimal points are not allowed.
Unit keys	Selects a unit and thus determine the absolute value, or changes the unit, i.e. trigger a recalculation without changing the absolute value. The function depends on the time at which the UNIT key is used during parameter entry (see chapter 4.4.5, "Working with Units" , on page 66). For unit-free values, the X1 key is equivalent to ENTER. It confirms the previous entry and deactivates the input field.
_	Adds a blank in a character input field.
*... #	Enters special characters. Toggles through the available characters if the key is pressed several times in a row.
A <-> a	Toggles between uppercase and lowercase characters.
A, B, C, D, E, F	Enters hexadecimal values. The letters assigned to the keys are automatically active when an entry field with a hexadecimal value is active.

ENTER

Pressing the rotary knob has the same effect.

- Concludes the entry of dimensionless entries. For other entries, this key can be used instead of the default unit key. The new value is accepted.
- Confirms ("OK") and closes open input windows.
- In a dialog box, selects the default or focused button.
- In a dialog box, activates the edit mode for the focused area, if available.
- In a dialog box, activates or deactivates the selected option of the focused area, if the edit mode is active.
- Calls the next menu level.

2.1.6 Rotary Knob and Navigation Keys

The rotary knob and the arrow keys are alternative control elements for data variation and navigation in the graphical user interface.



ROTARY KNOB

The rotary knob has several functions:

- Increases (clockwise direction) or decreases (counter-clockwise direction) numeric values at a defined step width in editing mode
- Moves the cursor, e.g. to a function block in the block diagram
- Scrolls within lists, tables or tree views
- Acts like the ENTER key, when it is pressed.
- Shifts the selection bar within focused areas (e.g. lists), if the edit mode is activated.

Note: Turning or pressing the rotary knob is equivalent to pressing the UP and DOWN keys or the ENTER key in the keypad.

NAVIGATION KEYS



The navigation keys consist of 4 arrow keys which are used for navigation, alternatively to the rotary knob.

UP/ DOWN KEYS The up and down arrow keys do the following:

- In a numeric edit dialog box, increase or decrease the instrument parameter.
- In a list, table, window or dialog box, scroll vertically.

LEFT/ RIGHT KEYS The left and right arrow keys do the following:

- In an alphanumeric edit dialog box, move the cursor forward and back.
- In a list, table, window or dialog box, scroll horizontally.

2.1.7 Front Panel Connectors

The RF and LF connectors and various additional interface connectors are located on the front panel.

LF



Output for internal LF modulation generator signal.

See also data sheet and [chapter 5.5.1, "Overview of LF Generator"](#), on page 291, [chapter 5.5.3, "LF Output"](#), on page 297.



AM EXT

Input for external AM modulation signals.



FM/PM EXT

Input for external FM or PhiM modulation signals (option R&S SMA-B20/-B22).



RF

Outputs for RF signal.

NOTICE! Maximum Input Levels. Do not overload the RF output. The maximum permissible back-feed is specified in the data sheet.

USB



USB (universal serial bus) interfaces of type A (host USB).

- Connection of peripherals such as mouse or keyboard
- Connection of memory stick for file transmission
- Firmware update

See also [chapter 2.4.1, "Connecting USB Devices"](#), on page 31.

SENSOR

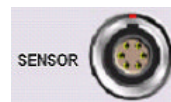

Connector for R&S NRP-Zxx sensors.

With the aid of the "User Correction" function, a table with correction values for external test assemblies can be automatically determined, e.g. for compensating the frequency response of cables.

The power sensors are connected by inserting the male connector. To disconnect hold the connector by its sleeve. Pulling on the sensor cable will not release the sensor connector.

See also [chapter 5.3.6.2, "NRP-Z Power Viewer"](#), on page 145.

2.2 Rear Panel Tour

This section gives an overview of connectors on the rear panel of the instrument. Each connector is briefly described and a reference is given to the chapters containing detailed information. For technical data of the connectors refer to the data sheet.



Fig. 2-2: Rear panel view

2.2.1 Description of the Connectors

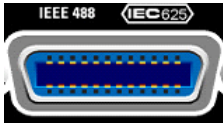

IEC 625/IEEE 488

IEC-bus (IEEE 488) interface for remote control of the instrument.

See also [chapter A.1, "GPIB Bus Interface"](#), on page 653 and [chapter 6.1.6, "GPIB Interface \(IEC/IEEE Bus Interface\)"](#), on page 320.

Note: In order to avoid electromagnetic interference (EMI) caused by open lines, always terminate any connected IEC-bus cable with an instrument or a controller.

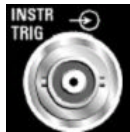

INSTR TRIG

Input for external trigger for sweeps, list mode and Fast Hopping Mode.

AUX I/O



Parallel input for FM/PhiM digital data signals as well as control signals for Fast Hopping mode.

NOTICE! Risk of instrument damage. The maximum permissible input voltage is 3.3 V DC.

For detailed description of the AUX I/O connector, refer to [chapter A.2, "AUX I/O Connector"](#), on page 654.



USB IN

USB (universal serial bus) interface of type B (device USB).

This interface can be used for remote control of the instrument.



USB CONNECTORS TYPE A

- Connection of peripherals such as mouse, keyboard, etc.
- Connection of memory stick for file transmission
- Firmware update

Further USB interface type A are available on the front panel.

See also [chapter 2.4.1, "Connecting USB Devices"](#), on page 31.



PULSE EXT

Input of external pulse signal or input of external trigger/gate signal for internal pulse generator.

See also [chapter 5.4.5, "Pulse Modulation \(PM\)"](#), on page 229 .



PULSE VIDEO

Output of internal pulse generator signal or external pulse signal fed in via the PULSE EXT connector (video signal).

See also [chapter 5.4.5, "Pulse Modulation \(PM\)"](#), on page 229 .

**PULSE SYNC**

Output of sync signal for pulse generator signal. The sync signal is generated at the beginning of each pulse. For double-pulse generation, the sync signal is generated at the beginning of the first pulse.

**EXT TUNE**

Tuning input for the internal reference frequency.

See [chapter 5.3.4, "Reference Oscillator"](#), on page 124.

**LAN CONNECTOR**

Ethernet interface

- For integrating signal generators in a network
- Remote control of signal generator
- Remote access to the signal generator
- Firmware update

See also:

- [chapter 2.6, "Setting Up a Network \(LAN\) Connection"](#), on page 34
- [chapter 6.1.3, "LAN Interface"](#), on page 316

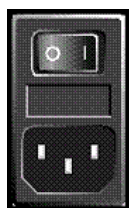
**AC SUPPLY AND POWER SWITCH**

When the R&S SMA is connected to the AC supply, it automatically sets itself to the correct range for the applied voltage (range: see type label). There is no need to set the voltage manually or change fuses.

The power switch can be set to two positions:

- **0**
The instrument is disconnected from the mains.
- **I**
The instrument is power-supplied. It is either ready for operation (STANDBY) or in operating mode, depending on the position of the ON/STANDBY switch on the instrument front.

See also data sheet and [chapter 2.3.3, "Connecting the Instrument to the AC Supply"](#), on page 27.

CF MEMORY SLOT

Slot for removable CompactFlash™ Card (option R&S SMA-B80).

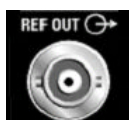
**REF OUT**

Output of internal reference signal.

See also [chapter 5.3.4, "Reference Oscillator"](#), on page 124.

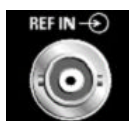
**REF IN**

Input for external reference signal.

See also [chapter 5.3.4, "Reference Oscillator"](#), on page 124.

**SENSOR**

Rear panel connector for R&S NRP-Zxx power sensors (option R&S SMA-B81).

This option is recommended for use of the instrument in a 19" rack. Installing the instrument in a 19" rack requires a rack adapter (refer to data sheet for Order No.).

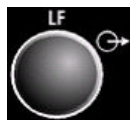
**LF**

Rear panel output for internal LF generator signal (option R&S SMA-B81).

This option is recommended for use of the instrument in a 19" rack. Installing the instrument in a 19" rack requires a rack adapter (refer to data sheet for Order No.).

**FM/PM EXT**

Rear panel input for external FM or PhiM modulation signals (option R&S SMA-B81).

This option is recommended for use of the instrument in a 19" rack. Installing the instrument in a 19" rack requires a rack adapter (refer to data sheet for Order No.).

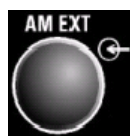
**AM EXT**

Rear panel input for external AM modulation signals (option R&S SMA-B81).

This option is recommended for use of the instrument in a 19" rack. Installing the instrument in a 19" rack requires a rack adapter (refer to data sheet for Order No.).

**RF OUT**

Rear panel output for RF signal (option R&S SMA-B81).

This option is recommended for use of the instrument in a 19" rack. Installing the instrument in a 19" rack requires a rack adapter (refer to data sheet for Order No.).

NOTICE! Maximum Input Levels. Do not overload the RF output. The maximum permissible back-feed is specified in the data sheet.

**CLK SYN**

Output of clock synthesizer (option R&S SMA-B29).

NOTICE! Maximum Input Levels. Do not overload the Clock Synthesizer output. The maximum permissible back-feed is specified in the data sheet.

See data sheet and [chapter 5.6, "Clock Synthesis"](#), on page 311

2.3 Putting into Operation

This section describes the basic steps to be taken when setting up the R&S SMA for the first time.

⚠ WARNING**Risk of injury and instrument damage**

The instrument must be used in an appropriate manner to prevent electric shock, fire, personal injury, or damage.

- Do not open the instrument casing.
- Read and observe the "Basic Safety Instructions" at the beginning of this manual or on the documentation CD-ROM, in addition to the safety instructions in the following sections. Notice that the data sheet may specify additional operating conditions.

NOTICE**Risk of instrument damage**

Note that the general safety instructions also contain information on operating conditions that will prevent damage to the instrument. The instrument's data sheet may contain additional operating conditions.

NOTICE**Risk of instrument damage during operation**

An unsuitable operating site or test setup can cause damage to the instrument and to connected devices. Ensure the following operating conditions before you switch on the instrument:

- All fan openings are unobstructed and the airflow perforations are unimpeded. The minimum distance from the wall is 10 cm.
- The instrument is dry and shows no sign of condensation.
- The instrument is positioned as described in the following sections.
- The ambient temperature does not exceed the range specified in the data sheet.
- Signal levels at the input connectors are all within the specified ranges.
- Signal outputs are correctly connected and are not overloaded.

NOTICE**Risk of electrostatic discharge**

Protect the work area against electrostatic discharge to avoid damage to electronic components in the modules. For details, refer to the safety instructions at the beginning of this manual.



EMI impact on measurement results

Electromagnetic interference (EMI) can affect the measurement results. To avoid any impact, make sure that the following conditions are met:

- Use suitable double-shielded cables.
- Do not use USB connecting cables exceeding 1 m in length.
- Use only USB devices that remain within the permissible EMI limits.
- Always terminate any connected IEC-bus cables with an instrument or controller.

Outputs and lines have to be terminated properly with 50 Ohms.

For digital interfaces only the cable R&S SMA-Z6 is permitted for connection. The associated cable is available under part number 1415.0201.02.

2.3.1 Unpacking and Checking the Instrument

To remove the instrument from its packaging and check the equipment for completeness proceed as follows:

1. Pull off the polyethylene protection pads from the instrument's rear feet and then carefully remove the pads from the instrument handles at the front.
2. Pull off the corrugated cardboard cover that protects the rear of the instrument.
3. Carefully unthread the corrugated cardboard cover at the front that protects the instrument handles and remove it.
4. Check the equipment for completeness using the delivery note and the accessory lists for the various items.
5. Check the instrument for any damage. If there is damage, immediately contact the carrier who delivered the instrument. Make sure not to discard the box and packing material.



Packing material

Retain the original packing material. If the instrument needs to be transported or shipped at a later date, you can use the material to protect the control elements and connectors.

2.3.2 Placing or Mounting the Instrument

The R&S SMA is designed for use under laboratory conditions, either on a bench top or in a rack using a rack adapter kit (order number see data sheet).

Bench Top Operation

If the R&S SMA is operated on a bench top, the surface should be flat. The instrument can be used in horizontal position, standing on its feet, or with the support feet on the bottom extended.

CAUTION**Risk of injury at the operating site**

The feet may fold in if they are not folded out completely or if the instrument is shifted. This may cause damage or injury.

- Fold the feet completely in or completely out to ensure stability of the instrument. Never shift the instrument when the feet are folded out.
- When the feet are folded out, do not work under the instrument or place anything underneath.
- The feet can break if they are overloaded. The overall load on the folded-out feet must not exceed 500 N.

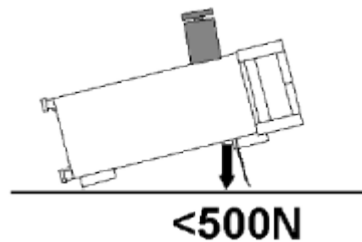
**Rackmounting**

The R&S SMA can be installed in a rack using a rack adapter kit (Order No. see data sheet). The installation instructions are part of the adapter kit.

NOTICE**Risk of instrument damage in a rack**

An insufficient airflow can cause the instrument to overheat, which may disturb the operation and even cause damage.

Make sure that all fan openings are unobstructed, that the airflow perforations are unimpeded, and that the minimum distance from the wall is 10 cm.

2.3.3 Connecting the Instrument to the AC Supply

The R&S SMA is automatically adapted to the AC voltage supplied. There is no need to set the voltage manually or change fuses. The [AC SUPPLY AND POWER SWITCH](#) is at the rear of the unit.

- ▶ Connect the instrument to the AC power source using the AC power cable delivered with the instrument.

Note: The instrument is in compliance with safety class EN61010-1. Connect the instrument only to a socket with earthing contact.

2.3.4 Starting the Instrument



Switching off the AC power

You can leave the AC power on permanently to preserve your last instrument settings. Switching off is required only if the instrument must be completely disconnected from all power supplies.

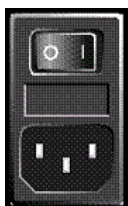

Starting up instruments with power switch

1. [Connect the instrument to the AC supply.](#)
2. To turn the power on, press the main power switch to position I (On).
After power-up, the instrument is in [standby or ready state](#), depending on the state of the ON/STANDBY key at the front panel of the instrument when the instrument was switched off for the last time.
3. In case the instrument is in standby mode, i.e. the yellow LED is on, press the ON/STANDBY key to switch the instrument to ready state.

2.3.4.1 Standby and Ready state

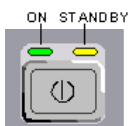

The ON/STANDBY key is located in the bottom left corner of the front panel.

Switching between standby and ready state

- ▶ Press the ON/STANDBY key briefly to switch the instrument from the standby to ready state or vice versa.

In ready state, the left, green LED is on. The instrument is ready for operation. All modules are power-supplied and the R&S SMA initiates its [startup procedure](#).

In standby state, the right, yellow LED is on. The standby power only supplies the power switch circuits and the oven-controlled crystal oscillator to keep it at its operating temperature. In this state it is safe to switch off the AC power and disconnect the instrument from the power supply.

2.3.4.2 Start Display and Booting

The instrument boots the operating system, starts the instrument firmware and automatically performs a selftest. If the previous session was terminated regularly, the instrument uses the last setup with the relevant instrument settings.

Once the startup procedure has been terminated, the block diagram opened in the previous session is displayed and the instrument is ready for operation.



Use the PRESET key to return the instrument to its definite reset/preset state, if the current setup is not anymore relevant.

To customize the start settings, use the "File" dialog.



Rebooting the instrument

Press the STANDBY key for approx. 5 s. to reboot the instrument, if the software stops unexpectedly.

2.3.4.3 Function Check

The signal generator automatically monitors the main functions when the instrument is switched on and continuously during operation.

A detected fault is indicated by a "ERROR" message displayed in the info line together with a brief error description. For in-depth identification of the error, press the INFO key. In response, a description of the error(s) is displayed.

For more information, refer to [chapter 9, "Error Messages"](#), on page 647.

Additionally to the automatic monitoring, the R&S SMA offers the following capabilities to ensure correct functioning:

- **Internal Adjustments**
Press the SETUP key and select "System > Internal Adjustments" to access the dialog for performing and configuring of the adjustments settings. A maximum level accuracy can be obtained, for instance.
- **Selftest**
A selftest is provided for service purposes. The selftest is a protected test procedure, which can be accessed if protection level 1 is disabled.

2.3.4.4 Default Settings

When the instrument is switched on, it is not the preset state that is active, but rather the instrument state that was set before the instrument was switched off. It is also recommended that you use the PRESET key to return the instrument to its defined preset state every time a new configuration is required or the current setup is not anymore relevant.

The R&S SMA offers a two-stage preset concept:

- **Preset the instrument to a predefined state**
The PRESET key calls up a defined instrument setup. All parameters and switching states are preset (also those of inactive operating modes). The default instrument settings provide a reproducible initial basis for all other settings. However, functions that concern the integration of the instrument into a measurement setup are not changed, e.g. GPIB bus address or reference oscillator source settings.
- **Preset the instrument to its factory settings**
The instrument can also be forced to load its default factory settings. To access the corresponding dialog box, press the SETUP key and select the "Factory Preset". For more information and an overview of the settings affected by the factory preset function, see [chapter 5.2.3.17, "Factory Preset"](#), on page 102.

Overview of the Most Important Preset States

The following list gives an overview of the presets for the most important generator settings. The other presets can be found in the preset tables of the individual menus and the information accompanying the remote commands.

- "RF frequency" = 1 GHz
- "RF level" RF output switched off
- "Offsets" = 0
- "Modulations State" = Off
- Uninterrupted level settings are switched off
"Level Attenuator Mode" = AUTO
- Internal level control "Level ALC" = AUTO
- User correction "Level Ucor" = OFF
- "LF output State" = Off
- "Sweep State" = Off
- "List mode State" = Off

Settings that are not affected by the PRESET key

- Reference frequency settings ("Ref Oscillator" menu)
- Power on settings ("Level/EMF" menu)
- Network settings ("Setup" menu)
- GPIB address ("Setup" menu)
- *IDN? Identification and emulation ("Setup" menu)
- Password and settings protected by passwords ("Setup" menu)
- Start/Stop Gui Update ("Setup" menu)
- Display and keyboard settings ("Setup" menu)



User-defined instrument states can be stored and called up in the "File" dialog.

2.3.5 Shutting Down the Instrument

To shut down the R&S SMA, proceed as described below.

NOTICE**Risk of losing data**

If you switch off the running instrument using the rear panel switch or by disconnecting the power cord, the instrument loses its current settings. Furthermore, program data may be lost.

Press the ON/STANDBY key first to shut down the application properly.

1. Press the ON/STANDBY key to save the current setup, shut down the operating system and set the instrument to standby state.

The yellow LED must be on.

2. To switch off the power, press the main power switch to position 0 (Off).

None of the front-panel LEDs should be on.

2.3.6 Power Fuses

The R&S SMA is fully fused by two fuses IEC60127-T3.15H/250 V.

The fuses are accommodated in the fuse holders next to the power connector. Use only fuses of the mentioned type.

WARNING**Shock hazard**

Before replacing a fuse, make sure that the instrument is switched off and disconnected from all power supplies.

Always use fuses supplied by Rohde & Schwarz as spare parts, or fuses of the same type and rating.

2.4 Connecting External Accessories

The equivalent USB ports on the front and/or rear panel of the R&S SMA can be used to connect a variety of accessories.

In addition the instrument provides interfaces for network integration (see [chapter 2.6, "Setting Up a Network \(LAN\) Connection"](#), on page 34).

2.4.1 Connecting USB Devices

The USB interfaces on the front and (optionally) rear panels of the R&S SMA allow you to connect USB devices directly to the instrument. This number can be increased as

necessary by using USB hubs. Due to the large number of available USB devices, there is almost no limit to the expansions that are possible with the R&S SMA.

The following list shows various USB devices that can be useful:

- Memory stick for easy transfer of data to/from a computer (e.g. firmware updates)
- CD-ROM drives for easy installation of firmware applications
- Keyboard or mouse to simplify the entry of data, comments, file names, etc.
- Power sensors, e.g. of the NRP Zxy family

Installing USB devices is easy under Linux, because all USB devices are plug&play. After a device is connected to the USB interface, the operating system automatically searches for a suitable device driver.

If Linux does not find a suitable driver, it will prompt you to specify a directory that contains the driver software. If the driver software is on a CD, connect a USB CD-ROM drive to the instrument before proceeding.

When a USB device is subsequently disconnected from the R&S SMA, the operating system immediately detects the change in hardware configuration and deactivates the corresponding driver.

All USB devices can be connected to or disconnected from the instrument during operation.

Connecting a memory stick or CD-ROM drive

If installation of a memory stick or CD-ROM drive is successful, the operating system informs you that the device is ready to use. The device is made available as a new drive (`/usb`). The name of the drive is manufacturer-dependent.

Connecting a keyboard

The keyboard is detected automatically when it is connected. The default keyboard layout is English – US.

Use the "Setup > Keyboard Settings" dialog to configure the keyboard properties.

Connecting a mouse

The mouse is detected automatically when it is connected.

2.5 Linux Operating System

The instrument contains the Linux operating system. To ensure that the instrument software functions properly, certain rules must be adhered to concerning the operating system.

NOTICE**Risk of causing instrument unusability**

The instrument is equipped with the Linux operating system. Additional software can therefore be installed on the instrument. The use and installation of additional software may impair instrument function. Thus, run only programs that Rohde & Schwarz has tested for compatibility with the instrument software.

The drivers and programs used on the instrument under Linux have been adapted to the instrument. Existing instrument software must always be modified using only update software released by Rohde & Schwarz.

The configuration of the operating system is optimally adapted to signal generator functions in the factory. Changes in the system setup are only required when peripherals like keyboard are installed or if the network configuration does not comply with the default settings (see [chapter 2.6.1, "Connecting the Instrument to the Network"](#), on page 34). After the R&S SMA is started, the operating system boots and the instrument firmware is started automatically.

**Accessing Operating System**

The operating system cannot be accessed.

All necessary system settings can be made in the "Setup" dialog.

The R&S SMA provides a internal CompactFlash™ Card, it does not contain a disk drive. The CompactFlash™ Card holds the firmware and the stored data. However, data transfer is only possible via a memory stick connected to a USB interface. The memory stick and the CompactFlash™ Card are accessed via the "File Manager".

Accessing the File System

The instrument also supports two standard methods to access the file system from a remote client:

- FTP (file transfer protocol)
- File sharing according to the SAMBA/SMB (server message block) protocol.

Both methods allow the access to the folder `/var/user/share`.

**Default password**

The FTP and SAMBA file access use the user "instrument" with default password "instrument".

It is highly recommended to change this password in the [Setup > Security > Change User Password](#) dialog before connecting the instrument to the network!

Screen saver

A screen saver can be activated in the R&S SMA. When active, the display is shut off when no entries via front panel, external mouse or external keyboard are made for a period of time. The screen saver prolongs the life time of the display.

Use the "Setup > Display Settings" dialog to switch on or off the screen saver and to adjust the screen saver settings.

2.6 Setting Up a Network (LAN) Connection

The R&S SMA is equipped with a network interface and can be connected to an Ethernet LAN (local area network). Provided the appropriate rights have been assigned by the network administrator and the Linux firewall configuration is adapted accordingly, the interface can be used, for example:

- To transfer data between a controller and the tester, e.g. in order to run a remote control program.
See [chapter 6, "Remote Control Basics"](#), on page 314.
- To access or control the measurement from a remote computer using the "Remote Desktop" application, the Ultr@VNC program (or a similar tool)
- To connect external network devices (e.g. printers)
- To transfer data from a remote computer and back, e.g. using network folders

This section describes how to configure the LAN interface. It includes the following topics:

- [chapter 2.6.1, "Connecting the Instrument to the Network"](#), on page 34
- [chapter 2.6.2, "Assigning the IP Address"](#), on page 35



Accessing Operating System

The operating system cannot be accessed.

All necessary system settings can be made in the "Setup" dialog.

2.6.1 Connecting the Instrument to the Network

There are two methods to establish a LAN connection to the instrument:

- A non-dedicated network (Ethernet) connection from the instrument to an existing network made with an ordinary RJ-45 network cable. The instrument is assigned an IP address and can coexist with a computer and with other hosts on the same network.
- A dedicated network connection (Point-to-point connection) between the instrument and a single computer made with a (crossover) RJ-45 network cable. The computer must be equipped with a network adapter and is directly connected to the instrument. The use of hubs, switches, or gateways is not required, however, data transfer is still performed using the TCP/IP protocol.

In both cases, an IP address has to be assigned to the instrument and the computer, see [chapter 2.6.2, "Assigning the IP Address"](#), on page 35.

The R&S SMA uses the IP addresses 192.168.xxx.yyy for this purposes, where xxx and yyy may take values between 1...254; the subnet mask is always 255.255.255.0.

NOTICE**Risk of network failure**

Before connecting the instrument to the network or configuring the network, consult your network administrator. Errors may affect the entire network.

- ▶ To establish a non-dedicated network connection, connect a commercial RJ-45 cable to one of the LAN ports.
To establish a dedicated connection, connect a (crossover) RJ-45 cable between the instrument and a single PC.

If the instrument is connected to the LAN, the operating system automatically detects the network connection and activates the required drivers.

The network card can be operated with a 10 Mbps Ethernet IEEE 802.3 or a 100 Mbps Ethernet IEEE 802.3u interface.

2.6.2 Assigning the IP Address

Depending on the network capacities, the TCP/IP address information for the instrument can be obtained in different ways.

- If the network supports dynamic TCP/IP configuration using the Dynamic Host Configuration Protocol (DHCP), all address information can be assigned automatically.
- If the network does not support DHCP, the instrument tries to obtain the IP address via Zeroconf (APIA) protocol. If this attempt does not succeed or if the instrument is set to use alternate TCP/IP configuration, the addresses must be set manually.

By default, the instrument is configured to use dynamic TCP/IP configuration and obtain all address information automatically. This means that it is safe to establish a physical connection to the LAN without any previous instrument configuration.

NOTICE**Risk of network errors**

Connection errors can affect the entire network. If your network does not support DHCP, or if you choose to disable dynamic TCP/IP configuration, you must assign valid address information before connecting the instrument to the LAN. Contact your network administrator to obtain a valid IP address.

Assigning the IP address on the instrument

1. Press the SETUP key and select the "Network Settings" dialog.

2. Set the "Address Mode" to Static.
3. Select the "IP Address" and enter the IP address, for example *192.168.0.1*.. The IP address consists of four number blocks separated by dots. Every block contains 3 numbers in maximum.
4. Select the "Subnet Mask" and enter the subnet mask, for example *255.255.255.0*. The subnet mask consists of four number blocks separated by dots. Every block contains 3 numbers in maximum.

Assigning the IP address manually on a PC

1. Obtain the IP address and subnet mask for the R&S SMA and the IP address for the local default gateway from your network administrator. If necessary, also obtain the name of your DNS domain and the IP addresses of the DNS and WINS servers on your network. If you use more than one LAN connector, you need separate address information for each connector.
2. Press the "Windows" key to access the operating system.
3. Open the "Control Panel" by selecting "Start > Settings > Control Panel".
4. Select "Network Connections".
5. Right-click "Local Area Connection" and select "Properties" from the context-sensitive menu, or click "Local Area Connection" and then "File > Properties".
6. On the "General" tab, click "Internet Protocol (TCP/IP)" and then select "Properties".
7. Select "Use the following IP address" and enter the address information as obtained from the network administrator.
8. If necessary, you can also select "Use the following DNS server addresses" and enter your own DNS addresses.

For more information refer to the Windows XP Help.

2.6.3 Using Computer Names

Alternatively to the IP address, each PC or instrument connected in a LAN can be accessed via an unambiguous computer name. Each instrument is delivered with an assigned computer name, but this name can be changed.

Querying and changing a computer name

1. Press the "Setup" key and select "Network Settings".
The computer name is displayed under "Hostname".
2. Press the "Setup" key, select "Protection" and enable the "Protection Level 1".
The parameter "Hostname" in the "Network Settings" dialog is now enabled for configuration.

3. Change the "Hostname".

2.7 Remote Access via an External Controller

The R&S SMA can be remote accessed from a remote computer (external controller) via a network link. This allows convenient operation of the instrument from the desktop although the instrument is integrated in a rack somewhere else.



For an overview of the instrument's operating concept and the different ways to control and operate the instrument, see [chapter 3.1, "Brief Introduction to the Instrument's Concept"](#), on page 44.

There are different ways to establish a remote access connection to the signal generator but all of them require an established LAN connection between the instrument and the remote computer. The simplest way to remote access the instrument is to use a Web browser, such as Windows Internet Explorer or Mozilla Firefox for instance. Alternatively a remote access via a special application can be used.

The free-of-charge program Ultr@VNC for PCs with Linux/Unix or Windows operating system is available for setting up the remote access connection. Using this application requires additional installation.

See the following table for an overview of the different ways to establish a remote access connection to the signal generator.

Table 2-1: Remote access via an external computer

Remote access via	LAN connection	Installation of the additional application	
		on the instrument	on the remote computer
Web Browser e.g. Windows Internet Explorer or Mozilla Firefox see chapter 2.7.1, "Using a Web Browser for Remote Access" , on page 38	required	no	no
Ultr@VNC for PCs with Linux/Unix or Windows operating system see chapter 2.7.2, "Remote Access via Ultr@VNC" , on page 39	required	required	VNC Viewer required

When the connection is set up with Ultr@VNC, direct control on the instrument is possible while remote access is established.

For return to direct operation on the instrument, the connection must be cut. After cutting the connection, it is still enabled and can be established again any time. The connection is disabled only after deactivation of the program.

This section gives an information on how to use the Web browser for remote access, how to install the applications for remote access and how to establish the connection between

the instrument and an external computer with Windows operating system. Remote access via an external computer with Linux/Unix operating system is performed accordingly.



Default password

Remote-access and file access require the user "instrument" with default password "instrument".

NOTICE

Changing the default user and security passwords

It is highly recommended to change the default user and security passwords in the menu "Setup > Security" before connecting the instrument to the network (see section [chapter 5.2.3.15, "Security"](#), on page 98).

2.7.1 Using a Web Browser for Remote Access

The instrument can be remote-accessed via any Web browser, like Windows Internet Explorer or Mozilla Firefox for instance.

To remote access the instrument via Web browser:

1. Connect the instrument and the remote computer to a LAN, see [chapter 2.6.1, "Connecting the Instrument to the Network"](#), on page 34.
2. Instal the Java Runtime Environment JRE on the remote computer.
3. Type the instruments' IP address in the address field of the Web browser on your PC, e.g. *http://10.111.11.1*

The "VNC Authentication" screen appears.

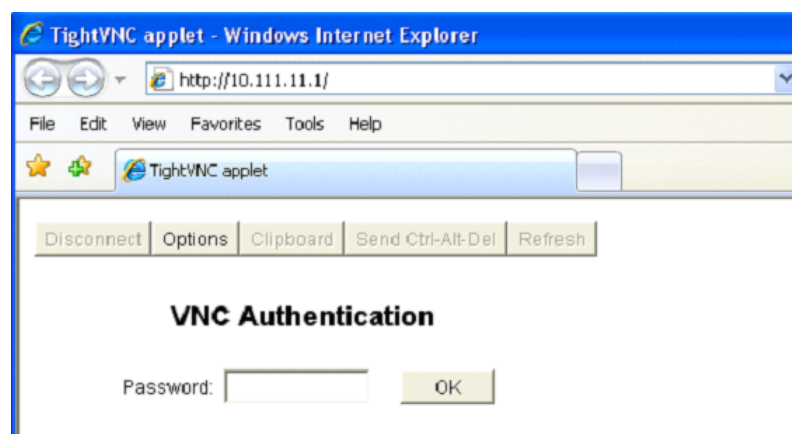

4. Enter the password and select "OK".

The default password is "instrument".

After the connection is established, the current signal generator screen with the block diagram is displayed and the instrument can be remote-accessed from the remote computer.

2.7.2 Remote Access via Ultr@VNC

Ultr@VNC is an application which can be used to access and control the instrument from a remote computer through a LAN connection. The program is included in operating system Linux/Unix. It is available as a free-of-charge download on the internet for operating system Window XP (<http://www.uvnc.com/download/index.html>) and on the instrument's CD-ROM.

NOTICE

Risk of Unauthorized Access

If the VNC application is enabled on the instrument, any user in the network who knows the computer name and login data can access it. To prevent this, make sure that the VNC server service on the instrument is disabled.

Setting up a VNC connection

1. Connect the instrument and the remote computer to a LAN, see [chapter 2.6.1, "Connecting the Instrument to the Network"](#), on page 34.
2. [Install the Ultr@VNC application](#) and enable it on the instrument.
3. In the ICF firewall, enable communication on the network via Ultr@VNC program.
4. Install the VNC Viewer on the remote computer with Windows operating system, see ["Installing the VNC Viewer on a Windows PC"](#) on page 41.
5. Set up the VNC connection between the instrument and:
 - a) the remote computer with Linux/Unix operating system, see ["Setting up the VNC connection on the Linux/Unix remote computer"](#) on page 41;
 - b) the remote computer with Windows operating system, see ["Setting up the VNC connection on the Windows remote computer"](#) on page 42.



Enabled Direct Control

The direct control of the instrument is not disabled and the instrument can be controlled from the front panel and via the remote computer alternately.

Installing the Ultr@VNC application

1. Download the program from the internet and copy it to a directory that can be accessed.
2. On the instrument, shut down firmware using the ALT+F4 key combination.

3. Double click on the setup file to start the installation.
The setup wizard leads through the installation. This description focus only on the relevant settings.
 - a) Select installation of all components.

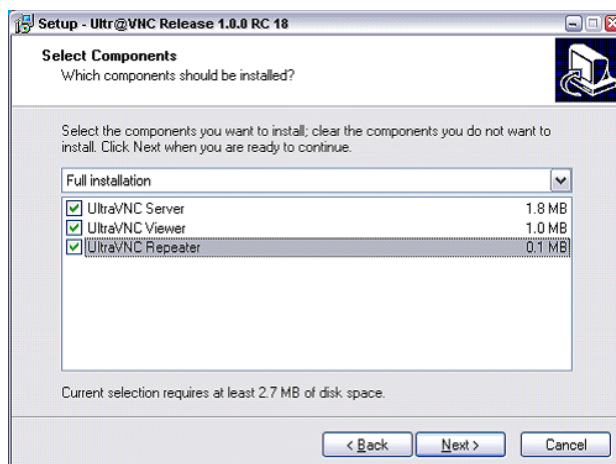

- b) In the "Additional Task Panel", enable all entries.

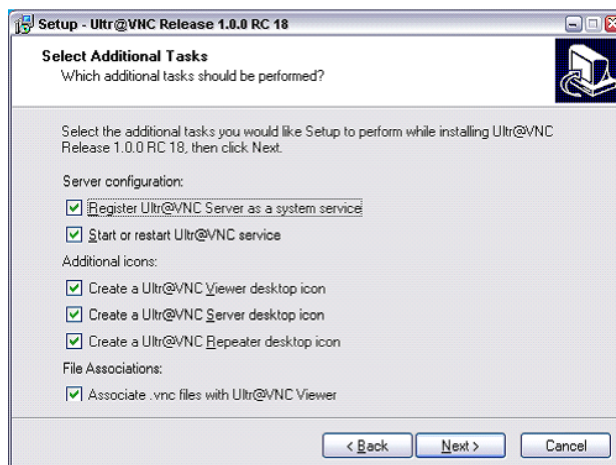

A successful installation is indicated by a message.

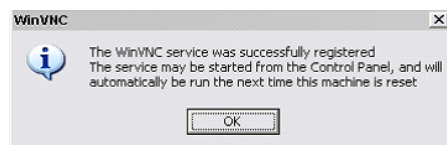

At the same time a warning is displayed stating that a password must be set.



4. Select "OK".
The "Default Local System Properties" panel opens.

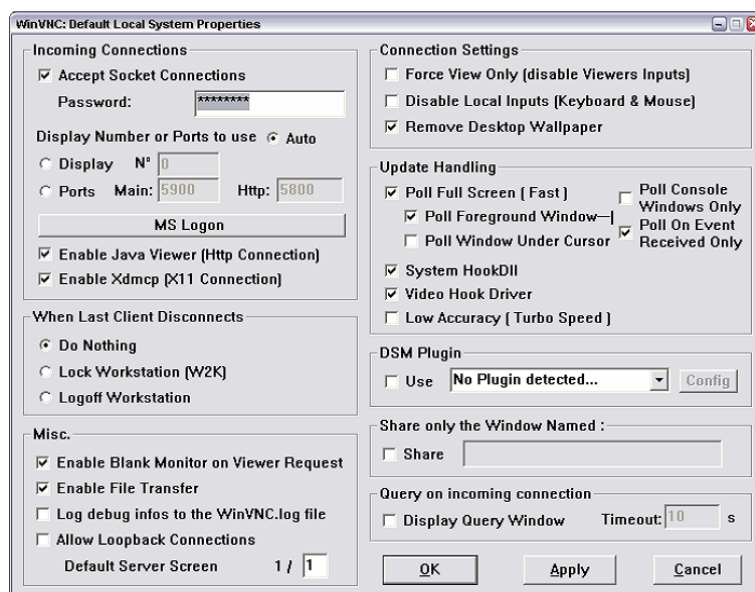

5. Enter a password with a length of at least five digits.
This password is used on the remote computer to access the instrument. Other settings may be changed according to the user-specific security requirements.

After the installation the Ultr@VNC program is automatically started together with the operating system. On mouse over, the IP address of the instrument is indicated. This IP address and the user-defined password are the prerequisites to enable remote access on the remote computer. Terminated connection is indicated by changed icon color.

Installing the VNC Viewer on a Windows PC

1. Download the Ultr@VNC program from internet and follow the installation instructions.
Only the program component VNC Viewer is required.

Note: The VNC Viewer program is included in the download for the installation of the Ultr@VNC program on the signal generator if "Full installation" was selected in the "Select Component" panel. In this case, the program `ultr@vncviewer.exe` can be copied to the Windows PC.

2. Install VNC Viewer program component on the remote computer.

Setting up the VNC connection on the Linux/Unix remote computer

The VNC program is available per default for Linux/Unix operating systems.

1. Start a Web browser on the remote computer and enter the IP address of the instrument.
2. Enter the following address:
`vnc://<IP-address of the instrument>`, e.g. `vnc://192.168.1.1`.
A dialog is opened and the password for the remote VNC connection is requested.

3. Enter the password as defined in the "Default Local System Properties" panel of the Ultr@VNC program and select "Log On".

The connection is established, the instrument is remote accessed and the current signal generator screen with the block diagram is displayed. The individual functions are operated using the mouse and keyboard.

In contrast to remote access via Remote Desktop, the direct control of the instrument is not disabled and the instrument can be controlled from the front panel and via the remote computer alternately.

Setting up the VNC connection on the Windows remote computer

1. Start VNC Viewer program component on the PC, select "VNC Server" and enter IP address of the instrument.

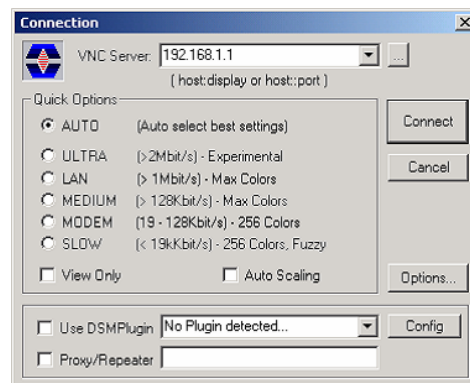

2. To initialize the connection, select "Connect".

A message requesting the password appears.

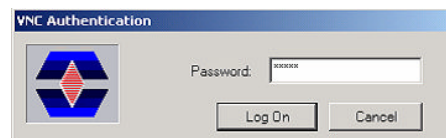

3. Enter the password as defined in the "Default Local System Properties" panel of the Ultr@VNC program and select "Log On".

The connection is established, the instrument is remote accessed and the current signal generator screen with the block diagram is displayed. The individual functions are operated using the mouse and keyboard.



Enabled Direct Control

The direct control of the instrument is not disabled and the instrument can be controlled from the front panel and via the remote computer alternately.

Terminating VNC Connection

The remote access via VNC connection can be terminated either on the R&S SMA or on the external PC. Terminating the connection does not disable it. It can be established again any time. See the notice above concerning unauthorized access due to VNC connection!

1. Terminate the connection on the R&S SMA
 - a) Press the "Windows" key to access the operating system.
 - b) Right-click on the VNC icon on the task bar and select "Kill all clients".
2. To terminate the connection on the external Linux/Unix PC, close the internet browser or close the signal generator window.
3. To terminate the connection on the external Windows PC, close the VNC Viewer program.

The connection is terminated. The color of the VNC icon in the status bar of the instrument changes.

A message on the external PC indicates the disconnection.

Disabling Remote Access via Ultr@VNC

The VNC connection can be disabled by removing the program on the instrument or by deactivating the VNC Server service.

1. Remove the VNC program
 - a) Press the "Windows" key to access the operating system and open the "Add or Remove Programs" by selecting "Start > Settings > Control Panel > Add or Remove Programs".
 - b) Remove the VNC program.
2. Deactivate the VNC Server service
 - a) Press the "Windows" key to access the operating system and open the "Services" by selecting "Start > Settings > Control Panel > Services".
 - b) Deactivate the VNC Server service.

The connection is disabled, the VNC icon disappears from the task bar of the instrument.

3 Getting Started

This section helps you to get familiar with the R&S SMA and provides an introduction to the general concept of the instrument with a sample of the possible application fields as well as a description of the main blocks in the signal generation flow.

This section also explains the operating concept in general and includes a brief introduction to operation by a step-by-step description of the configuration. The example is intended to provide a quick overview of the settings provided. No additional equipment is required.

3.1 Brief Introduction to the Instrument's Concept

The **operating concept** of the R&S SMA employs the following three ways of instrument control:

- Manual operation
- Remote control
- Remote access

Manual Operation

The R&S SMA can be entirely operated from the front panel. Peripherals such as mouse or keyboard can be connected but are not essential.

The R&S SMA is equipped with an intuitive user interface. The central element of the display is the block diagram that shows the signal flow and processing from the left on the display to most right, i.e. the generated signal can be seen at a glance.

Each block represents a functional unit of the instrument. Thus the user always knows the position at which a parameter has an effect in the signal flow. The main settings of a block are indicated in the block. The interconnection of employed inputs and outputs is also shown. The user is thus always informed about the connection of inputs and outputs in the signal flow and where they can be configured. A window is opened for each menu where parameters can be set. When the window is opened, an entry is made in the "Winbar" below the display. All open menus are of equal priority (not modal) and can be accessed any time.

The block diagram in the figure below shows a fully equipped instrument.

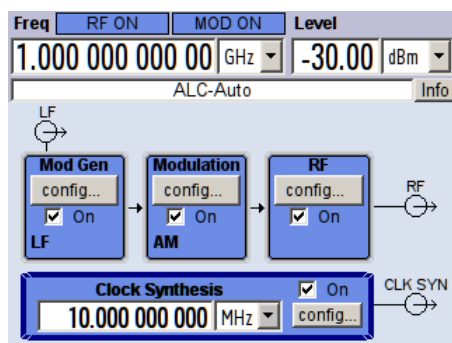

Fig. 3-1: Block diagram of a fully equipped R&S Signal Generator

With the aid of the rotary knob, the user can navigate in the block diagram and the dialogs, and can operate the instrument with one hand. The cursor is moved line by line through the block diagram or dialog. Turning the button clockwise advances the cursor. The selected block can be activated or deactivated with the TOGGLE key. Active blocks are highlighted by a colored background.

The instrument comprises a comprehensive info and help system. Context-sensitive help can be called any time with the HELP (F1) key. The help system indicates the currently selected parameter and offers additional services such as cross references, index and contents. The content of the help system corresponds to the operating manual of the instrument.

Warning and conflict messages caused by incorrect operation as well as further information are displayed in the "Info" line. A complete list of existing conflicts is displayed when the INFO (CTRL+I) key is pressed. Additional information on entries can be requested from the help system. The history function permits display of all messages.

Assistants simplify the completion of tables. After data entry in the assistant, the table is modified only after the "Accept" button has been pressed. Pressing the "Accept" button also stores the assistant data.

For an introduction into the manual operating of the instrument, detailed operating instructions and an overview of menus refer to [chapter 4, "Manual Operation"](#), on page 54.

For an indepth description of the dialog boxes and the instrument functions refer to section [chapter 5.1, "Overview of Instrument Functions"](#), on page 79.

Remote Control

Remote control is an operation of the instrument by means of remote control commands or programs that automatize repeating settings. The instrument is connected to a computer running the program.

This way of operation and the instructions how to set up a connection for remote control are described in the [chapter 6, "Remote Control Basics"](#), on page 314. The description of the remote control commands is provided in [chapter 7, "Remote Control Commands"](#), on page 354.

Remote Access

Remote access is the operating of the instrument from a remote computer. Both the R&S SMA and the computer are connected in a LAN.

Remote access in contrast to **remote control** does not use remote-control commands but a separate software which is installed on the remote computer. After its start, the software simulates the user interface of the instrument. The instrument can thus be operated from the remote computer as on the unit itself. The individual functions are operated using the mouse and keyboard. Specific instrument functions can be executed using specific key combinations on the keyboard or a front panel key emulation that can be operated with the mouse.

This way of operation and the instructions how to set up a connection for remote access are described in [chapter 2.7, "Remote Access via an External Controller"](#), on page 37.

3.2 Application Field of the Instrument

The main field of application of the R&S SMA is the generation of sine wave signals with very high spectral purity. These signals are needed e.g. for adjacent channel or phase noise measurements.

In addition, the RF signal can be modulated with a wide variety of internal modulations waveforms, e.g. sine waves, triangle/rectangular/trapeze signals, and noise. Several modulation signals can be combined with variable weight.

3.3 Description of Individual Diagram Blocks

The signal path of the instrument is configured by installing a frequency option that comprises all required modules including synthesizer, output section and attenuator (optional without attenuator).



One of the following options must be installed.

- R&S SMA-B103 (up to 3 GHz)
- R&S SMA-B103L (up to 3 GHz, without attenuator)
- R&S SMA-B106 (up to 6 GHz)
- R&S SMA-B106L (up to 6 GHz, without attenuator)

Instruments without step attenuator provide a restricted level range at the RF output. Refer to the data sheet for detailed information.

See data sheet for detailed information.

Up-to-date information is available at R&S SMA homepage on the internet <http://www2.rohde-schwarz.com/product/sma100a.html>.



Mod Gen block

The internal modulation sources are configured in this block. Also, the "LF frequency sweep" can be activated here.

Two internal LF generators (second is optional) are available as the internal source(s) for the analog modulations AM, FM and PhiM. Different modulation shapes - sine, triangle, rectangle and noise - are offered for the second LF generator. Bandwidth and level distribution can be selected for the noise signal of the noise generator (optional).

Available modulation shapes are:

- sine
- triangle (optional)
- square (optional)
- trapeze (optional)
- noise with selectable bandwidth and level distribution (optional)

The internal modulation signals are provided at the LF output at the front of the instrument. The LF output signal and the modulations sources for the analog modulations AM, FM and PhiM can be selected independently from each other.

A pulse generator provides single and double pulse modulation with selectable pulse widths and periods. Additionally, an option is available to generate pulse train signals.

The R&S SMA offers three different sweep types (frequency sweep, level sweep and LF sweep) to be activated alternatively. Each type has 6 modes which differ with respect to the sweep cycle mode (continuous, individual and step-by-step) and triggering mode (automatic, internal and external). In the "Mod Gen" block, the LF sweep is configured. Frequency and level sweep settings are accessed via the "RF" block.

The status display in the block shows whether LF generator and/or a sweep are active. The selected internal LF generator and/or noise source are switched on or off with the TOGGLE ON/OFF key.

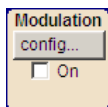

Modulation block

The internal and external analog modulations are configured and activated in this block. The MOD ON/OFF key switches the active modulation(s) on/off.

The internal modulation sources are configured in the "Mod Gen" block. The modulation inputs AM EXT, FM/PHIM EXT and PULSE EXT at the rear of the instrument are provided for external amplitude, frequency, phase and pulse modulation. AC or DC coupling for external feed is possible.

Modulation signals of up to three sources (two internal sources and one external source) can be combined for AM/FM and PhiM modulation.

Available internal and external analog modulation modes are:

- Amplitude modulation (AM)
- Frequency modulation (FM, optional)
- Phase modulation (PhiM, optional)
- Pulse modulation (Pulse)
- Chirp modulation (internal only)

In addition, external digital modulation signal can be used. The external signal for digital FM/PhiM modulation is fed in via the AUX I/O interface.

- Digital Frequency modulation (optional)
- Digital Phase modulation (optional)

Note: For modulation modes that can be simultaneously used, refer to the R&S SMA data sheet.

The status display in the block shows the active modulation(s). Use the TOGGLE ON/OFF key to switch the active modulation of the block on or off.



RF block

In this block, the RF parameters and frequency/level sweep settings are set.

The active sweep is displayed in the block. The RF ON/OFF key switches the RF signal on and off. When the signal is switched off, the switch before the RF output symbol is open.

RF settings include:

- Frequency and reference frequency
- Level settings; if required.
- NRP-Z Power Viewer and Power Analysis using power sensors
- Frequency and level sweep
- List Mode settings. In this mode, extremely fast frequency and level settings can be made.

The RF 50 OHM output connector at the front of the instrument provides the RF signal. An external trigger/gate signal for sweeps is input via the INST TRIG connector at the rear of the instrument

Note: Frequency and level are set fast with the aid of the FREQ and LEVEL keys. Use the TOGGLE ON/OFF key to switch the RF output on or off.

Clock Synthesis

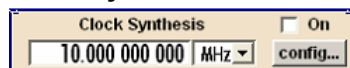

In this block, the clock synthesis is switched on or off and the frequency of the clock signal is set. For instruments equipment with modules with order number 1400.2749.02 DC offset can be defined, in addition.

The clock frequency is displayed in the block. Use the TOGGLE ON/OFF key to switch the generation of clock signal on or off.

3.4 Example of Setup

This section provides an example on how to configure the instrument for generating of an amplitude modulated signal and of a frequency modulated signal with noise.

Generation of an Amplitude-Modulated Signal

To generate a simple AM-modulated signal, proceed as follow:

1. Activate default (preset) state
Press the PRESET key to set a defined instrument state.

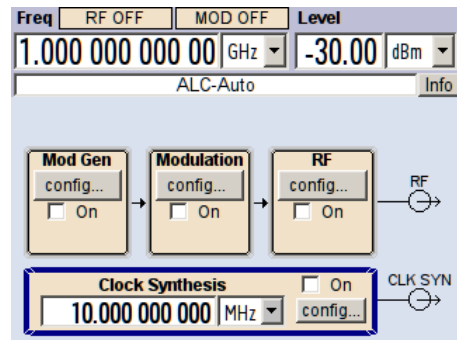

2. Select and activate AM modulation
 - a) Turn the rotary knob and select the "Mod" block.



- b) Press the rotary knob to open the dialog where the modulation can be selected (different modulation modes are available depending on the options installed).

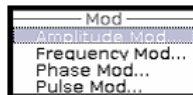

The "Amplitude Mod..." menu is the first menu and is highlighted per default.

- c) Turn the rotary knob and highlight "Amplitude Mod...". Press the rotary knob to open the "Amplitude Modulation" dialog.

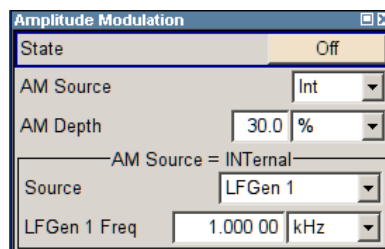

- d) Turn the rotary knob to select parameter "AM Depth", press the rotary knob to allow editing and enter the preferred AM depth with the aid of the numeric keypad and the unit keys.

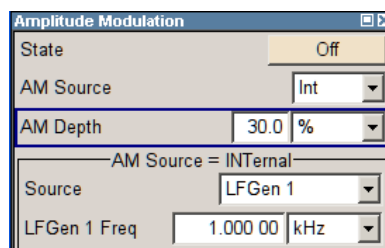

- e) Finally, select "State" and press the rotary knob to switch on the AM modulation.

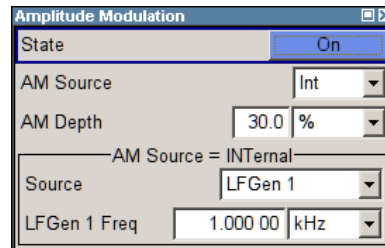

- f) Press the DIAGRAM key to display the complete block diagram.

To indicate the active state, the "Mod" block is displayed in blue. The "RF" is not yet active, which means that no RF signal is output.

3. Set frequency and level and activate RF signal

- a) Press the FREQ key to activate the editing mode for frequency entry. The "Frequency" entry field in the header section of the display is highlighted.

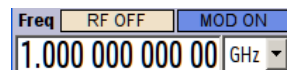

Enter the frequency using the numeric keypad and terminate the entry by pressing a unit key.

- b) Press the LEVEL key and enter the level settings in the same way.

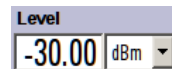

- c) Press the DIAGRAM key to display the complete block diagram.
d) Turn the rotary knob to select the "RF" block.

Press the RF ON/OFF key to activate the "RF" block.

The AM modulation signal is now present at the RF output.

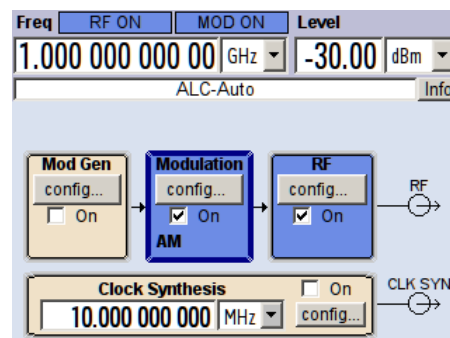

Generation of a Frequency Modulated Signal with Noise

To generate a simple FM-modulated with noise signal, proceed as follow:



This setting requires option Multifunction Generator, R&S SMA-K24.

1. Activate default (preset) state

Press the PRESET key to set a defined instrument state.

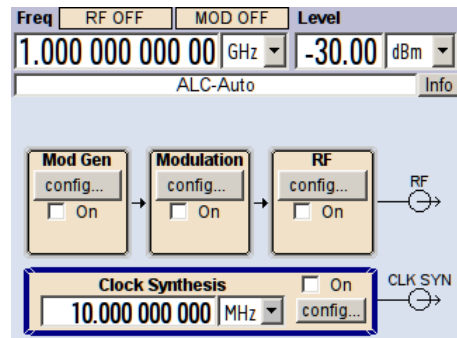

2. Select and activate FM modulation with internal noise signal and a deviation of 500 kHz

a) Turn the rotary knob and select the "Mod" block.



b) Press the rotary knob to open the dialog where the modulation can be selected (different modulation modes are available depending on the options installed).

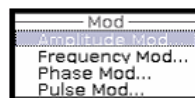

c) Turn the rotary knob and highlight "Frequency Mod...".

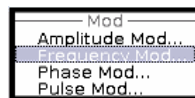

Press the rotary knob to open the "Frequency Modulation" dialog.

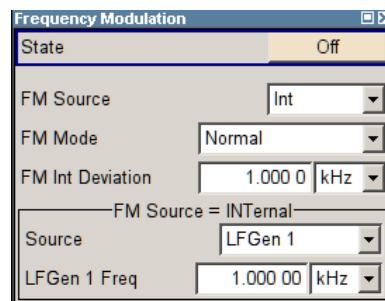

The internal source is the LF generator 1 by default. This setting is not changed.

- d) Turn the rotary knob to select parameter "FM Internal Source", press the rotary knob to open the selection list and select "Noise".

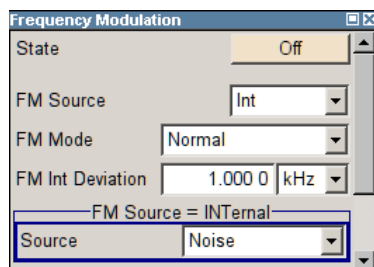

Gauss distribution and full bandwidth (10 MHz) are the default settings for the noise signal. These settings are not changed.

- e) Turn the rotary knob to select parameter "FM Int Deviation", press the rotary knob to allow editing and enter the preferred deviation with the aid of the numeric keypad and the unit keys.

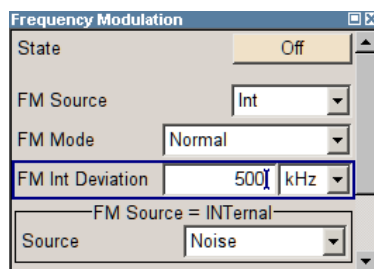

- f) Finally, select "State" and press the rotary knob to switch on the FM modulation.

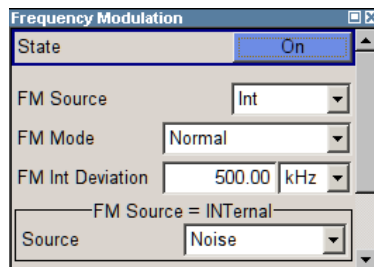

- g) Press the DIAGRAM key to display the complete block diagram.

To indicate the active state, the "Mod" block is displayed in blue. The "RF" is not yet active, which means that no RF signal is output.

3. Set frequency and level and activate RF signal

- a) Press the FREQ key to activate the editing mode for frequency entry. The "Frequency" entry field in the header section of the display is highlighted.

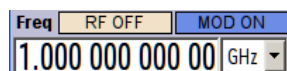

Enter the frequency using the numeric keypad and terminate the entry by pressing a unit key.

- b) Press the LEVEL key and enter the level settings in the same way.

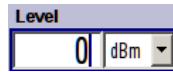

The noise now modulates the RF carrier.

- c) Press the DIAGRAM key to display the complete block diagram.
 d) Turn the rotary knob to select the "RF" block.
 Press the RF ON/OFF key to activate the "RF" block.

The FM modulation signal is now present at the RF output. The LF output is not yet activated, i.e., the modulation signal is not output there.

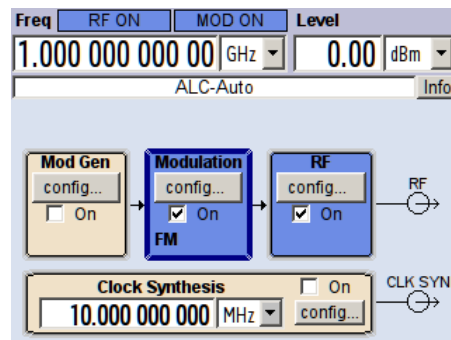

The graph below shows the FM modulated signal with noise (upper blue trace) and the unmodulated signal (lower green trace).

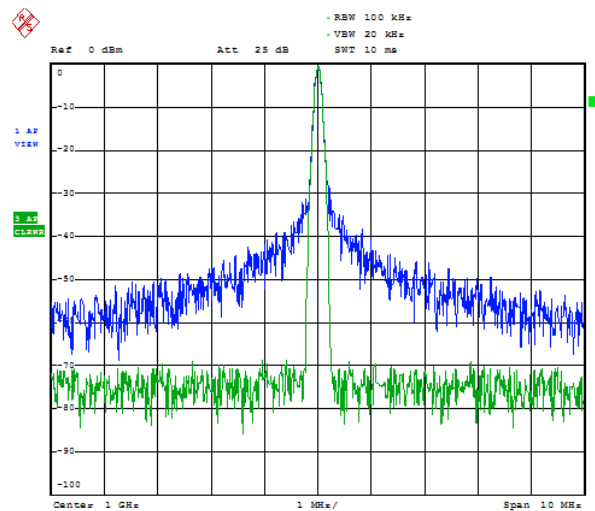

Date: 13. DEC. 2005 15:15:42

4 Manual Operation

The R&S SMA can be operated intuitively either via the interactive block diagram or via a menu tree. All menus are in the form of windows that can be operated in the same way. Rotary knob, keys and softkeys, or alternatively a mouse, allow direct and therefore convenient access to entries and settings.

The clear-cut display shows the current signal generator state. Numerous help functions support the user in signal configuration.

This section describes the concept of manual operation of the signal generator. This includes a description of the general structure of a dialog box, working with dialog boxes and the block diagram and the setting of parameters.

For an in-depth description of the dialog boxes and the instrument functions refer to section "Instrument Functions".

4.1 Key Features

The manual operating concept of the R&S SMA enables the user to make settings as intuitively as possible and at the same time gives a permanent overview of characteristics of the generated signal and of the current instrument state. Numerous online help functions support user settings.

Block diagram

The block diagram is the core of the operating concept.

A graphics display shows the current configuration and the signal flow in the form of a block diagram. All graphical elements can be accessed for operation. An element is selected by means of the arrow keys and the associated setting function is called by pressing Enter. Required menus and graphs are displayed on the block diagram which is displayed again in the foreground whenever the DIAGRAM (CTRL+D) key is pressed.

Permanent frequency and level display

The main characteristics of the RF signal, frequency and level, are permanently displayed in the header section of the screen and can be directly set in the display fields after the FREQ (CTRL+F) or LEVEL (CTRL+L) key is pressed. Status messages for the output signal are displayed in addition to frequency and level.

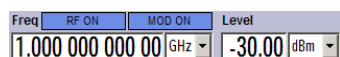

Operation via Graphical User Interface

- **Functional blocks**

Menus are assigned to the specific function blocks in the block diagram. The function blocks represent elements of signal generation. Function blocks displayed with a blue frame can be directly switched on and off by means of the TOGGLE ON/OFF (CTRL

+T) key. The menus of the highlighted function blocks can be called by pressing the ENTER key.

– **Example:**

The "Modulation" block contains all menus required for modulation signal configuration.

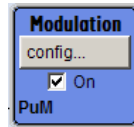

In this block all modulations can be selected.

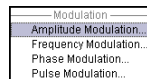

- **Signal flow**

The signal flow between the function blocks and the employed inputs and outputs are also shown.

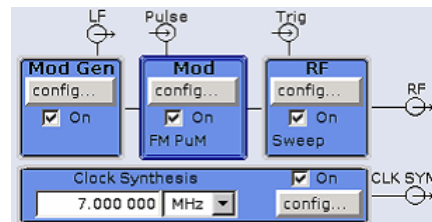

- **Menu tree**

The menu tree can be opened and closed with the MENU (CTRL+M) key. The menu tree is organized in the same way as the directories under Windows. The function blocks correspond to the first directory level, the menus to subdirectories.



Operation corresponds to the Windows concept

To offer the user a familiar environment, operation is very similar to operation of Windows user interfaces. All menus and tables are made up of known elements, such as selection lists, check boxes and entry fields.

A blue frame indicates that the selected item is active. In the highlighted element, entries can be made.

Rotary knob



Operation is possible via front-panel keys, an external keyboard and the mouse. However, most of the settings can be easily made with the rotary knob:

- Turning the rotary knob shifts the entry focus to the target element.
- Pressing the rotary knob activates the selected entry field. Depending on the parameter, the submenu is called, the numeric value varied, the list entry selected or the check box activated or deactivated.
- If a value is entered, the entry is stored by another click on the rotary knob and the editing mode is exited.

Clear settings with the aid of independent subdialogs

A separate window is opened for each dialog and subdialog. The dialogs can be operated independently of each other, i.e. none of the dialogs requires that settings in other dialogs be completed before it can be closed. This ensures flexible operation at all times.

Keys with assigned simple functions

Most keys on the front panel of the R&S SMA directly perform a simple function.

Since a great number of settings can thus be made by a keystroke, operation is easy. For instance, the CLOSE (ESC) key closes the active menu; with the RF ON/OFF (CTRL+R) key the RF output signal can be switched on or off.

An exception are keys that call a menu such as the MENU (CTRL+M) key which opens the complete menu tree of the instrument, the SETUP (CTRL+E) key which opens the menus for general instrument settings or the FILE (CTRL+S) key which opens the menu for file management.

Help functions for user support

Numerous help functions support the user in signal configuration.

- **Value ranges**

The valid setting range is displayed for each numeric parameter. This requires a short wait after activation of the entry field. The range is then displayed automatically after a few seconds.

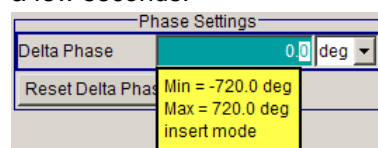

If the entered value is outside the permissible range, the next permissible value is automatically set and a message is output.

- **Context-sensitive help**

Context-sensitive help for each parameter can be called with the HELP or F1 key.

- **Comprehensive online help**

Each help page is part of a comprehensive online help function which can be called by means of an index, a content tree or the "Previous/Next" buttons.

Info line with messages for indication of the current instrument state

A great variety of different messages such as status messages, error messages, warnings or information are displayed in the header field of the screen. With the aid of the INFO (CTRL+I) key, help pages can be called for most of the messages. They provide background information on the message and indicate operating steps that may be required. All messages are explained in the online help which can be called with the HELP (F1) key.

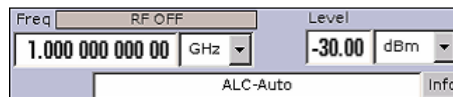

4.2 Display

The display shows the current signal generator state and offers graphical elements for direct operation. It is divided into three sections:

- The frequency and level display with info line indicates the main output signal parameters and reports the current state with status, error and warning messages.
- The block diagram shows the instrument configuration, the signal characteristic as well as the inputs and outputs used and permits interactive operation via graphics elements. Active menus and graphs are displayed on top of the block diagram.
- Winbar with labelled softkeys for menu display.

The block diagram in the figure below shows a fully equipped instrument.

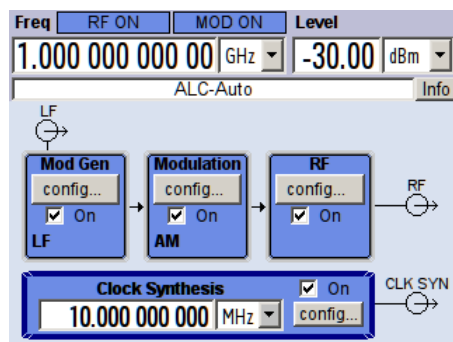

Fig. 4-1: Block diagram of a fully equipped R&S Signal Generator

4.2.1 Settings Displayed in the Header Section

Frequency/level settings and a few status messages (see [chapter 4.2.2, "Status Information and Messages"](#), on page 58) are displayed in the header field of the screen. The display may vary depending on the instrument's operating mode:

- In the sweep mode, the current frequency or level of the output signal is displayed. The status message "SweepMode" is displayed in the info line.

- In the list mode, neither the current frequency nor level is displayed, the indication is dimmed.
- If user correction is active, the status message "UCorr" is displayed in the info line.



The value displayed in the "Freq" and "Level" field does not consider any offset set or multiplier factor.

For more information see [chapter 5.3.2, "RF Frequency"](#), on page 115 and [chapter 5.3.5.1, "Overview of RF Level"](#), on page 127.

The frequency and level indication can be enlarged so that it covers the complete display of the R&S SMA by using the DIAGR key. This key toggles between block diagram, magnified frequency and level indication and the display of the active dialog. This requires the "Summary Screen Toggle" to be enabled.

See also ["Toggle Summary Screen"](#) on page 94.

4.2.2 Status Information and Messages

The status information and messages are displayed in the header section of the screen. The messages differ with respect to their importance (errors, warnings, info) and the time of their appearance (brief and permanent messages). They require different treatment by the user. Further information on all messages can be called in the info window (see [chapter 4.2.3, "Info Window"](#), on page 59).

Refer to [chapter 9, "Error Messages"](#), on page 647 for an overview of all status information and messages as well as instructions for error elimination.

4.2.2.1 Status Information

The status information gives the user an overview of the main operating states and settings of the instrument. The states are indicated for information only and do not necessitate any action by the user.

Status information is displayed between the frequency and level fields, at the left of the info line or in the info line itself.

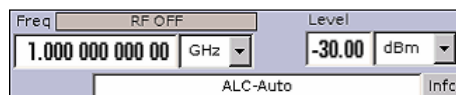

4.2.2.2 Messages

Messages indicate errors in the instrument. They are displayed in the info line in different colors depending on their importance and display duration. Errors (e.g. no calibration data) are displayed in red, information (e.g. file not found) and warnings in black. Warnings indicate less significant errors (e.g. the instrument operates outside specified data).

4.2.2.3 Volatile messages

Brief messages report automatic settings in the instrument (e.g. switching off of incompatible types of modulation) or on illegal entries that are not accepted by the instrument (e.g. range violations). They are displayed in the info line on a yellow background. They are displayed on top of status information or permanent messages.

Volatile messages do not normally demand user actions and disappear automatically after a brief period of time. They are stored in the history, however.

These messages can be read from remote using `SYST:ERR?` or `SYST:ERR:ALL?`.

4.2.2.4 Permanent Messages

Permanent messages are displayed if an error occurs that impairs further instrument operation, e.g. a hardware fault. The error signalled by a permanent message must be eliminated before correct instrument operation can be ensured.

The message is displayed until the error is eliminated. It covers the status display in the info line. After error elimination, the message automatically disappears and is also recorded in the history.

These messages can be read from remote using `SYST:SERR?`.

4.2.3 Info Window

A few operating states and the current message are displayed in the info line.

The INFO window with a list of current permanent messages and a detailed description of each message can be opened with the INFO (CTRL+I) key.

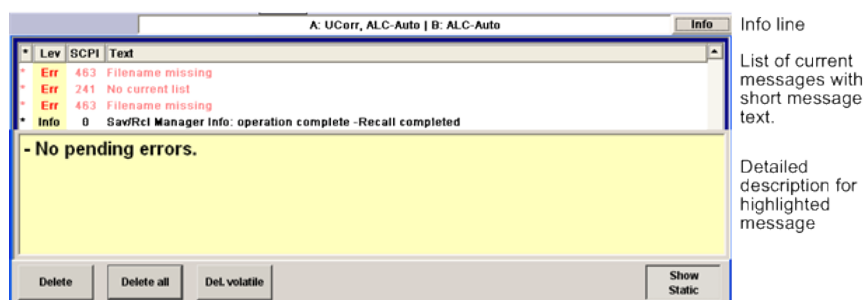

The upper section of the info window contains a list of all current permanent messages in the order of their occurrence, i.e. the most recent message is displayed first. In the lower section of the window, additional information on the highlighted message is displayed. A history of all messages that have occurred since instrument switch-on can be called with the "History" key. The most recent message is displayed first.

The messages are color-coded according to their level. Device-specific messages are red, info and remote control error are black. The level is also indicated in the "Lev" column (Err, Sys or Info). Column "SCPI" indicates the SCPI error code.

With the aid of the softkey buttons, error messages can be cleared and a history of all messages called.

Delete

Clears the highlighted message.

This button is available only if the history of the messages is displayed.

Delete All

Clears all messages.

This button is available only if the history of the messages is displayed.

History

Calls the list of all messages that have occurred since instrument switch-on. The most recent messages are displayed at the top of the list. When the button is pressed again, the list of current messages is displayed.

SCPI command:

[SYSTem:ERRor\[:NEXT\]?](#) on page 628 or [STATus:QUEue\[:NEXT\]?](#) on page 619

Each time a `SYST:ERR?` or `STAT:QUE?` query is sent, the oldest entry in the error queue is returned and at the same time cleared in the list.

4.2.4 Block Diagram

The block diagram shows provided options, signal configuration and the currently selected signal flow of the generator with inputs and outputs used. Signal generation can be completely operated from the block diagram. The highlighted function block can be directly switched on and off with the TOGGLE ON/OFF (CTRL+T) key. Pressing the Enter opens the associated setting menu.

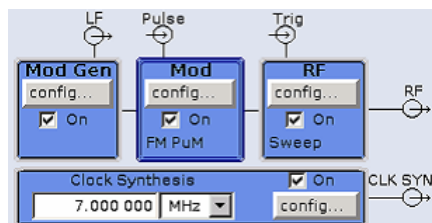
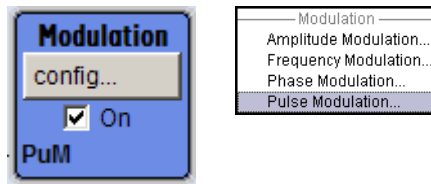

Fig. 4-2: Block diagram of the R&S SMA

4.2.4.1 Function Blocks in the Block Diagram

Each block represents a function of signal generation. The function is indicated in the headline of the block. In the check box, the respective function can be quickly activated/deactivated with the TOGGLE ON/OFF (CTRL+T) key. After activation, the block is displayed in blue. Status information is displayed below the check box. It is different for the different blocks.

Pressing the rotary knob (front panel) or the "Config..." button (mouse) opens the associated setting menu.

Example: Modulation block

In this block, the modulation signals are set. The status information of the "Modulation" block indicates the selected modulation.

4.2.4.2 Signal Flow and Input/Output Symbols in the Block Diagram

The input/output symbols in the block diagram show the currently used inputs and outputs of the signal generator. Unused inputs and outputs are not shown. The lines indicate the signal flow.

Symbols and labels refer to the corresponding inputs and outputs on the front and rear panel of the signal generator. The direction - input or output - is indicated by an arrow.

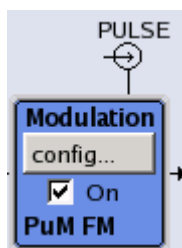
Example:

The symbols indicate the input for the external pulse signal on the instrument rear panel.

4.2.5 Structure of the Dialogs

The parameters are set in the menus. Menus are accessed either via the function blocks in the diagram or by means of the MENU (CTRL+M) key. The menus are displayed on top of the block diagram.

The WINBAR key toggles between the active menus. The REARR key toggles between the enlarged and normal sized menus.

Working with menus and dialog boxes is described in [chapter 4.3, "Accessing Dialogs"](#), on page 62; the setting of parameters in [chapter 4.4, "Setting Parameters"](#), on page 63.

The menus are in Windows format. The menus differ in details depending on their function but they consist of the same main elements. Each menu consists of a menu header and one or more menu areas with various fields for setting parameters.

The header line contains the name of the menu and the buttons for minimizing and closing the menu. To operate the buttons, use the mouse or the front key CLOSE (ESC).

Several fields of associated but separately set parameters are organized in menu areas. A menu area is framed and labelled with the function common to all parameters.

Example: Pulse Generator

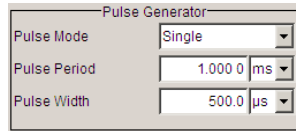

Each of the setting fields is assigned a parameter name. The kind of setting varies depending on the parameter to be set. Some settings can only be made in a specific configuration. If setting is not permitted with the specific configuration selected, the respective item is disabled and displayed in gray and the entry or selection field cannot be accessed.

4.3 Accessing Dialogs

The MENU (CTRL+M) key opens the complete menu tree. Selecting a functional block and pressing the ENTER key opens the menu associated with this block.

An alternatively way to access a dialog is to use the CLOSE (ESC), DIAGRAM (CTRL+D) and REARR (CTRL+A) keys on the front panel.

For a quick access to the dialogs, use one of the following alternative methods.

Displaying the block diagram or a dialog in the foreground

- ▶ Press the DIAGRAM (CTRL+D) key to move the cursor to the block diagram.
All active menus are minimized.

Enlarging the indication of the header section

- ▶ Press the DIAGRAM key twice to enlarge the indication of the header section.
Tip: Use the REARR key to toggle between the enlarged and normal sized dialogs.

Accessing the menu tree

- ▶ Press the MENU (CTRL+M) key to open the complete menu tree.

Calling the File or Setup dialog

- ▶ Use the FILE (CTRL+S) or SETUP (CTRL+E) keys to open the respective dialog.

Closing an active menu

- ▶ Press the CLOSE key to close an active menu.
Tip: If the cursor is at the highest menu level, you can also use the ESC key to close the active menu.

Accessing the header area

- ▶ Press the **FREQ** (CTRL+F) and **LEVEL** (CTRL+L) keys to activate the "Frequency" or "Level" entry fields in the header area.



Keyboard Shortcuts

Keyboard shortcuts (e.g. "Ctrl + D" for the displaying the block diagram in the foreground) provide direct access to all utility dialogs of the instrument (see [chapter 4.8, "Legend of Front-Panel Controls"](#), on page 76).

4.4 Setting Parameters

The R&S SMA offers several and sometimes alternative possibilities for setting parameters. Operation is possible from the front panel, with the aid of a mouse and/or from a PC keyboard.



The examples within this description focus on the operation from the front panel.



For more information, refer to:

- [chapter 4.8, "Legend of Front-Panel Controls"](#), on page 76 for an overview of key functions and a cross-reference between the front panel keys and the keyboard shortcuts
- section "Instrument Functions" for a detailed description of key functions.

Most of the parameters are set in the different menus. The R&S SMA provides alternative ways for accessing the dialogs. Turn the rotary knob and navigate to the corresponding block in the block diagram and press the knob to open the dialog or perform a mouse click on the "Config..." button.

An exception are the "Setup" and "File" dialogs. In the "Setup" dialog, general settings are made which are not directly concerned with signal generation, e.g. setting of the GPIB-bus address. In the "File" dialog, files and lists are managed.

These menus can only be called with the **SETUP** (CTRL+E) and **FILE** (CTRL+S) keys.

Frequency and level are directly set in the header area of the display using the **FREQ** and **LEVEL** keys.

Specific settings can also be made directly in the block diagram, e.g. activating a function block by means of the **TOGGLE ON/OFF** (CTRL+T) key or switching the RF output on and off with the aid of the **RF ON/OFF** (CTRL+R) key. Changes affecting the signal flow are immediately visible in the graphics display.

This section provides an information about the parameter handling that comprises of the following main steps:

- [chapter 4.4.1, "Working with the Cursor"](#), on page 64

- [chapter 4.4.2, "Selecting a Control Element"](#), on page 64
- [chapter 4.4.3, "Switching Parameters On/Off"](#), on page 65
- [chapter 4.4.4, "Entering a Value"](#), on page 65
- [chapter 4.4.5, "Working with Units "](#), on page 66
- [chapter 4.4.6, "Selecting a Value from a List"](#), on page 67
- [chapter 4.4.7, "Terminating Entries with Confirmation"](#), on page 68
- [chapter 4.4.8, "Restoring the Previous Value"](#), on page 68

4.4.1 Working with the Cursor

After the instrument is switched on, the cursor is always on the first function block of the diagram (default setting).

Moving the cursor on the display

- ▶ To move the cursor, use one of the following alternative methods:
 - a) Use the rotary knob or the arrow keys.
 - b) Use the WINBAR key to toggle between the active dialogs.
 - c) Use the ESC key.

Tip: Be aware that the function of the ESC key depends on the current cursor position. The function of this key depends on the current cursor position.

- Calls the next higher selection level.
- Closes the open window without accepting new entries; the old value or parameter is retained.
- In dialog boxes that contain a "Cancel" button it activates that button.
- Closes all kinds of dialog boxes, if the edit mode is not active.
- Quits the edit mode, if the edit mode is active.
- Switches between different entry fields of a menu.
- Shifts the entry cursor from the header display to the previously active menu, or to the previously highlighted block in the block diagram if no menu is active.

Moving the cursor to the heading area

- ▶ Press the **FREQ** (CTRL+F) or **LEVEL** (CTRL+L) key to move the cursor to the header area.

4.4.2 Selecting a Control Element

Control elements are always selected in the same way no matter whether a function block in the diagram, a menu in the menu tree, a parameter in the menu or an entry in a list or table is concerned.

- ▶ To activate an element, put the cursor on it.



An active element is highlighted by a blue frame.

4.4.3 Switching Parameters On/Off

A parameter can be activated and deactivated using a button or a check box.

1. Select the parameter.
2. To change the state of a parameter, use the "Enter" function of the different control media:
 - Press the rotary knob
 - Press ENTER
 - Press the TOGGLE ON OFF (CTRL+T) key.

Colour and label of a button change, the check box is ticked or the tick is removed.

4.4.4 Entering a Value

Numeric and alphanumeric values can be edited in the entry fields. In the editing mode, cursors of different colour are used. A blue cursor indicates the overwrite mode, a green cursor the insert mode.

Numeric and alphanumeric values can either be newly entered or the existing value can be changed. Incorrect entries are cleared with the BACKSPACE key.

Entering a new numerical value

1. Select the parameter.
2. Press a numeric key to activate the editing mode.

The previous value is cleared and the new value can be entered.

Editing a value in the insert mode (default setting)

1. Press the rotary knob (= Enter) to activate the editing mode.
If the cursor is placed at the right of the total value, the insert mode is always active.
2. Set the cursor to the left of the number to be changed using the LEFT/RIGHT arrow keys.
The cursor is displayed in green.
3. Click on a numeric key to insert a new value.



Editing a value in the overwrite mode

1. Activate the editing mode.

2. Set the cursor on the numeric digit to be changed using the LEFT/RIGHT arrow keys.
The cursor is displayed in blue and the number to be replaced is highlighted.
3. Click on a numeric key to overwrite the highlighted value.



Varying a value

1. Activate the editing mode.
2. Set the cursor to the left of the number to be changed using the LEFT/RIGHT arrow keys.
The value at the cursor position is varied.
3. To vary the selected value, use the UP/DOWN arrow key or turn the rotary knob.
The value is increased or decreased.

Entering a new alphanumerical value

1. Select the parameter.
2. Press an alphanumeric key to start the editing mode.
The new value is entered.

Editing an alphanumerical value

An existing value, e.g. a file name, can be changed in the insert mode (see example) or in the overwrite mode.

1. Select the parameter and activate the editing mode.
2. Set the cursor to the left of the alphanumerical value using the LEFT/RIGHT arrow keys.
Tip: If hexadecimal values are to be entered, the numeric front-panel keys are automatically changed to hexadecimal values.
3. Click on an alphanumeric key to insert a new alphanumerical value.

Terminating the entry of a numeric value

To terminate the entry of a numeric value:

1. Press the rotary knob (= Enter).
2. Press a UNIT key on the front panel.
3. Select a "Unit" in the selection field next to the parameter value.

4.4.5 Working with Units

The unit of a parameter is displayed next to the value. When the parameter is edited, the unit is selected either from the list or by means of the front-panel keys. When the entry

is completed, the unit can be changed. In this case the value remains unchanged but is automatically adapted to the new unit.



While operating the instrument by means of a mouse, assign the unit to the selected parameter before entering its value.

Assigning a unit

To assign a unit to a value, use one of the following alternatives:

1. Press a UNIT key on the front panel.



2. Select a "Unit" in the selection field next to the parameter value.
Press the ENTER key.

The unit displayed in the entry field next to the value is assigned.

Changing a unit

To subsequently change a unit, i.e. after the entry has been terminated and when the editing mode is not active, use one of the following alternatives:

1. Press a UNIT key on the front panel.
2. Select "Unit" in the selection field next to the parameter value.

The value remains unchanged but the display is automatically adapted to the new unit, i.e. the value is recalculated to suit the new unit.



The new unit is indicated in the value field of the menu.

4.4.6 Selecting a Value from a List

Selection lists provide a list of predefined values for the selected parameter.

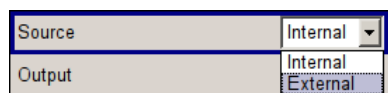

To select a item from a list, proceed as follow:

1. Press ENTER key to open the list.
2. Use one of the following alternatives to navigate through the list:
 - a) Turn the rotary knob or use the UP/DOWN arrow keys.
The selected item is highlighted.

- b) Press TOGGLE ON/OFF key several times until the preferred entry is displayed in the selection field.
3. To confirm the selection, press the ENTER key.

4.4.7 Terminating Entries with Confirmation

The instrument behaves different by the termination of entries depending on the parameter type and the way this parameter is set.

Confirming settings

- ▶ To confirm the settings, press the rotary knob or one of the UNIT keys (see also [chapter 4.4.5, "Working with Units"](#), on page 66).

Note: Variations by means of the rotary knob are immediately set.

Confirming multiple values

In some cases, like for instance when editing data in a user correction table, it is useful first to enter few values and to confirm them together. Such settings require additional confirmation. Not yet confirmed settings are displayed on a yellow background as an indication that the currently displayed values do not represent the target signal.

- ▶ To confirm these settings, select the "Save" or "Accept" button, respectively.

Confirming parameters with On/Off state

Most of the instrument functions with enabled and disabled states are calculated and effective only after this functions have been enabled. However, there are functions like the frequency variation of the reference oscillator for instance, that are immediately set after confirmation.

- ▶ To confirm a parameter with On/Off state, enable the parameter.

4.4.8 Restoring the Previous Value

Parameter variations with the rotary knob are immediately set and therefore not reversible.

Normally, values cannot be restored in the case of mouse control because no explicit confirmation is required in this case and entries are automatically confirmed when the entry or selection field is exited.

Restoring values

In the case of front-panel control or operation from the keyboard, previous values can be restored as long as the new value is not confirmed, i.e. the entry is not completed.

- ▶ To restore the values, press the ESC key.

Restoring values that require confirmation

All settings that are not confirmed with the "Accept" button but require this additional confirmation can be restored.

1. Press the ESC key.

A confirmation query is displayed.

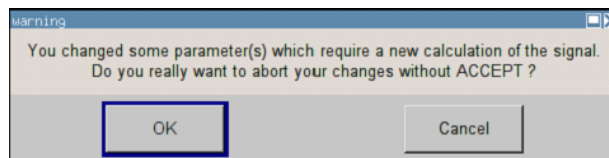

2. Confirm with "OK" to abort the changes.

Select "Cancel" to return to the dialog. The previous selected settings are displayed.

Restoring values after an extended calculation has been started

Calculation and setting might require different period of time. Many settings are made without noticeable calculation times; such operations are indicated by a "BUSY" message displayed in the status field of the header section.

A window with a progress indicates that the instrument performs an extended calculation that requires longer calculation time. The termination of such a calculation restores the previous values.

- ▶ Press the ABORT button to terminate the calculation.

All previous values are restored.

4.5 Editors

The R&S SMA provides user-friendly editors for defining lists. Lists containing frequency and level value pairs are used for the list mode and the user-defined level correction.

The lists are saved to files and may thus have any length. The file name of the lists and the directory to which the files are saved are user-selectable. The file prefix is different for each list type and is permanently assigned by the system.

For information about file handling and overview of the automatically assigned file prefixes, refer to [chapter 4.7, "File Management"](#), on page 72.

4.5.1 Working with List Editor

The "User Correction" and "List Mode" dialogs provide a list editor for defining the frequency/level value pairs.

Editing list mode data lists

1. To access a list editor and open an existing data list for editing, use the cursor keys to select the associated button "Edit User Correction Data..." or "Edit List Mode Data..." (if available) in the individual menu.

The selected list is displayed and the cursor marks the first row of the "Frequency/Hz" column.

	Frequency/Hz	Power/dBm
1	100 000.000	-140.00
2	100 010.000	-140.00
3	100 020.000	-140.00
4	100 030.000	-140.00
5	100 040.000	-140.00
6	100 050.000	-140.00
7	100 060.000	-140.00
8	100 070.000	-140.00
9	100 080.000	-140.00

Goto Edit Save

If no list has been selected, a blank list of only one row is displayed.

2. Press the LEFT/RIGHT arrow keys to change between the columns. Use the UP/DOWN arrow keys to mark a row.
3. Use the numeric keys to enter the value for the value pairs in the "Frequency/Hz" and "Power/dBm" table columns. A blank row is inserted at the end of the list. Terminate the entry by pressing a UNIT key.

4. To select a row, select the "GoTo" button and press the ENTER key. Use the numeric keys to enter the row index in the entry field and press the ENTER key to confirm the entry.

The cursor moves to the selected row.

5. To insert a new row in the table, select the row above which the new row is to be inserted and select "Insert Row(s)".

A row is inserted above the currently marked row.

If no row has been selected, a row is inserted at the beginning of the list.

6. Use the "Save" function to save the edited list under its current name. Enter the file name in the "File Select" dialog and select the directory (see [chapter 4.7.1, "File Select Dialog"](#), on page 73).

Only complete value pairs are taken into consideration; rows containing an entry in only one column are ignored.

Creating a new list mode data list

A new list can be created under a new name either by generating a blank file in the "File Select" menu (see section [chapter 4.7, "File Management"](#), on page 72) or by changing an existing list which will then be saved under a new name.

1. To create an empty data list, select "RF > List Mode > List Mode Data... > New List" or respectively "RF > User Correction > User Cor. Data... > New User Correction Data" and enter the file name of the new data list.

- To open the data list for editing, select the associated button "Edit User Correction Data..." or "Edit List Mode Data..." in the individual menu.
Edit the list and save it under a new name.

4.6 How to Use the Help System

The R&S SMA is equipped with a context-sensitive help function. A help page is available for each parameter and can be called any time during instrument operation.



Compiled online help systems are also available for all functions of the R&S SMA on the CD-ROM supplied with the instrument. This help program can be called on any controller with Internet Explorer version V4.0 and higher.

Calling context-sensitive and general help

- ▶ To display the general help dialog box, press the HELP (F1) key.

The help dialog is displayed. A topic containing information about the current menu or the currently opened dialog box and its function is displayed.

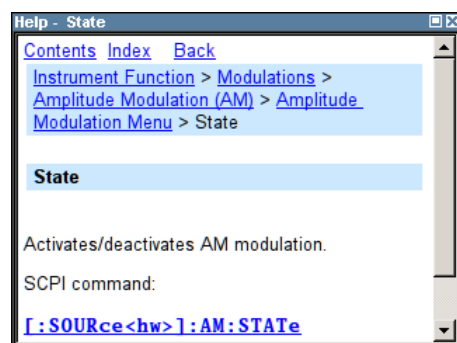

On top, the help dialog box contains a navigation bar with:

- "Contents" - accesses a table of help contents
- "Index" - switches to an index table
- "Back" / "Previous" / "Next" for navigation to further help topics

Navigating in the table of contents

- To move through the displayed contents entries, use the UP/DOWN keys. Entries that contain further entries are marked with a plus sign.
- To display a help topic, press the "ENTER" key.
The corresponding help topic is displayed.

Navigating in the help topics

- To scroll through a page, use the UP/DOWN arrow keys.
- To jump to the linked topic, press the link text.

3. Use the "Previous" or "Next" links to jump to the corresponding topic.

Using the Index

1. Select "Index".
2. Enter the first characters of the topic you are interested in. The entries starting with these characters are displayed.
3. Press the ENTER key to change the focus.
4. Use the UP/DOWN keys to navigate and select the suitable keyword.
5. Press the ENTER key to display the help topic.
The corresponding help topic is displayed.

Closing the help window

- ▶ Press the HELP (F1) key.

4.7 File Management

The R&S SMA uses files to save all instrument data, i.e. system and user data.

The user data includes saved instrument settings and lists and the user correction.

The files are stored on the CompactFlash™ card of the instrument. The `/var` directory can be used to save user-defined data; any subdirectory structure can be created on `/var`. Some default subdirectories are predefined, but can be changed at any time.

The `/opt` directory is a protected system drive and therefore unaccessible system directory. The files on this directory contain data that must not be changed. Therefore, this drive should not be accessed, since reconstruction of the system partition will lead to data loss. To prevent inadvertent deletion or overwriting of system files, this drive is not specified in the file menus.

Files can be exchanged either via a memory stick or a connected network. A memory stick is connected to the USB interface and is assigned the `/usb` drive. In the case of a connected network, all network drives that can be accessed are available. The files are accessed in a "Save/Recall" dialog in the individual menus.

The files are differentiated according to their extensions; each type of file is assigned a specific file content. The extension is usually of no consequence to the user since access to the files occurs in the individual menus where only the relevant type of file is available. See [chapter 4.7.2.1, "Extensions for User Files"](#), on page 75 for an overview of the supported file extensions.

The user data can be roughly divided into the following data types:

- Settings
Instrument settings can be saved and loaded. In case of saving, the current setting is saved to the specified file.
- Lists

Lists, e.g. user correction lists, can be loaded. They can be generated either externally or internally. For internal generation, a new list must be created in the "File Select" dialog which will then be edited in the list editor of the individual menu.



For more information, refer to:

- [chapter 4.8, "Legend of Front-Panel Controls"](#), on page 76 for an overview of key functions and a cross-reference between the front panel keys and the keyboard shortcuts
- to section "Instrument Functions" for a detailed description of key functions.

Accessing files with user data

1. To access an editable user data file, select the "Save/Recall" or "File Manger" function in the individual dialog.



2. To access a loadable data file, select the "Select/New" or "File Manager" function in the individual dialog.

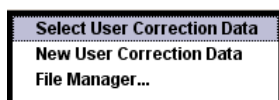

3. To access the "File Manager" function, press the SETUP (CTRL+E) key and select "Save/Recall > File Manager".

A "File Select" window for loading, saving or creating a file or the "File Manager" dialog for managing all files is displayed.



Saving and loading of all instrument settings

All instrument settings are saved and loaded in the "File" menu.

To access the "File" menu, press the FILE (CTRL+S) key.

For more information, see [chapter 5.2.8, "Storing and Loading Instrument Data - File Key"](#), on page 108.

4.7.1 File Select Dialog

The "Save/Recall" dialog displays the available drives and directories. In the upper part, "Recent Data Sets", the files last used are listed.

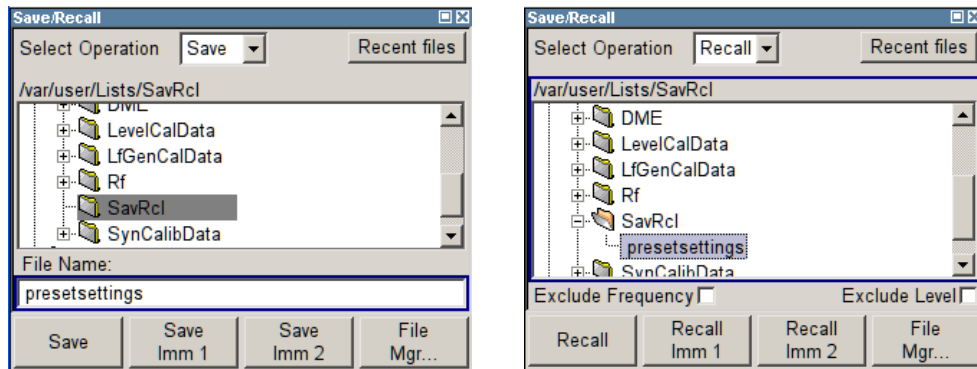

The available drives and directories and the files of the selected directory are displayed. The currently selected path is displayed above the window. Only the relevant files without file extensions are displayed. If the area is opened several times, the path last selected is displayed. When a file is saved or created, its name is user-selectable; the extension is assigned automatically and cannot be entered. The file is saved to the selected path.

In addition to the files saved by the user, some menus also offer files containing predefined contents. These files are saved to a specific directory on system drive; for this reason, this directory cannot be chosen from the "File Select" menu.

Working with the File Select dialog

1. Access the "File Select" dialog (see ["Accessing files with user data"](#) on page 73).
2. Navigate in the "File Select" dialog.
3. Load an existing file.
In the "Recall Settings" dialog, mark a file and press the "Select" button.
4. Save a file.
In the "Save Settings" dialog, enter file name in the "File Name:" field.
Select the directory to which the file is to be saved and then select the "Save" button.
5. Create a new file.
To create a new file, use the "Save Settings" functionality, i.e. specify file name and directory and save the file.

The created file is empty; it must be filled with the necessary values in the individual editor.

4.7.2 File Manager

The "File Manager" allows general file management such as copying, shifting, renaming and deleting files as well as generating new directories.

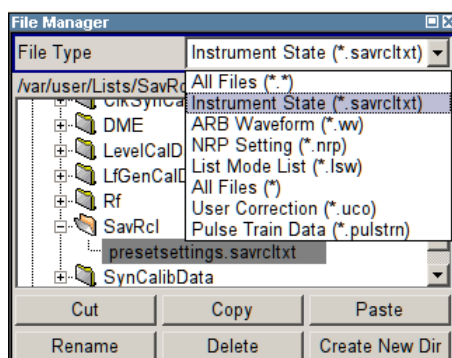

Use the "File Type" to select a file type form the list. This can be used to process either all files (all files (*) selection) or a specific selection of files. See [chapter 4.7.2.1, "Extensions for User Files"](#), on page 75 for an overview of the supported file extensions. The available drives and directories and the files of the selected directory are displayed. The currently selected path is displayed above the windows. If the area is opened several times, the path last selected is displayed. Unlike the "File Select" window, the "File Manager" displays the full file names including extensions.

Working with the File Manager dialog

1. Accessing the "File Manager" dialog (see ["Accessing files with user data"](#) on page 73).
2. Navigating in the "File Manager" dialog.
Operation is similar to the operation of menus with several areas.
3. Moving, duplicating, deleting or renaming files
To move a file, select the file and press the "Cut" button. Mark the directory to which the file is to be moved and select the "Paste" button. If the target directory already contains a file with the same name, a confirmation query is displayed to confirm overwriting of this file.
Perform the similar steps and cut/copy/rename/delete the file.
Tip: The operation corresponds to the Windows concept.
4. Creating a new directory
Mark drive or directory level where the new directory is to be created, select the "Create New Directory" button and enter the name of the new directory in the entry window that opens. Confirm with ENTER.

4.7.2.1 Extensions for User Files

The following table list all available file extensions for user files. The currently available files on the instrument depends on the installed options.

Table 4-1: List of the automatically assigned file extensions in the instrument

Function	List type	Contents	File suffix
Instrument State	Settings	Instrument settings	*.savrltxt
"User Correction"	List	User-defined level correction values	*.uco

Function	List type	Contents	File suffix
		Export Data	*.txt or *.csv
"List Mode"	List	User-defined frequency/level value pairs	*.lsw
		Export Data	*.txt or *.csv
"Pulse Train List"		User-defined offtime/ontime/repetition values	*.pulstrn
NRP Settings	Settings	NRP Settings	*.nrp

4.8 Legend of Front-Panel Controls

The following table lists all key functions available on the front panel. Key combinations used on the PC keyboard to trigger key functions on the instrument front panel are also described. Keyboard labels are described in alphabetical order.

In addition, a front panel key emulation and an on-screen keyboard can be used for manual operation by mouse only.

Table 4-2: Cross-reference between the front panel keys and keyboard shortcuts

Front-panel key	Key of PC keyboard	Function
Turning the rotary knob	Tab key (towards the right) Shift + Tab (towards the left)	Sets the cursor with the rotary knob.
Pressing the rotary knob	Enter	Pressing the rotary knob confirms an entry; it has the same function as the ENTER key.
Arrow keys	Arrow keys	Moves the cursor.
ENTER / *1 / dB(m)	Enter ALT + F12	Terminates an entry. Confirms entries in the base unit and values without a unit. Selects dBm for the RF level and dB for level offset and level step width.
. / *...#	. / *...#	Enters a period/decimal point. Enters a special character.
- / A<->a	- / (shift+) a—z	Enters the sign. Switches between upper-case and lower-case letters.
0-9 / a...z	CTRL+ 0-9 / a...z CTRL	Enters the number/letter.
BACKSPACE	Backspace	Clears the last entry (number, sign or decimal point)
ESC / CLOSE	ESC / CTRL + G	Selects the next higher menu/selection level. When the editing mode is exited with ESC, the previous value is restored. Closes an active menu.
DIAGRAM	CTRL+ D	Sets the cursor on the block diagram and hides all menus.
FILE	CTRL + S	Activates the menu for storing instrument settings.

Front-panel key	Key of PC keyboard	Function
FREQ	CTRL+ F	Activates the frequency entry.
G/n / dBuV	ALT + F9	Selects the unit Giga/Nano, dBuV for the RF level and dBu for the LF level.
HELP	F1	Opens/closes context-sensitive help.
INFO	CTRL + I	Opens/closes the info window
k/m / mV	ALT + F11	Selects the units kilo/milli and mV for RF levels.
LEVEL	CTRL + L	Activates the level entry.
LOCAL	CTRL + Q	Switches the instrument from remote control to manual control.
M/u / uV	ALT + F10	Selects the units Mega/Micro and uV for RF levels.
MENU	CTRL + M	Calls the menu selection list.
MOD ON/OFF	CTRL + O	Switches modulation on/off. "MOD OFF" is indicated in the status line.
ON/OFF TOGGLE	CTRL + T	Switches a block or parameter on/off. Toggles between the different possibilities of setting a selection parameter.
PRESET	CTRL + P	Restores a defined basic instrument setup.
REARR	CTRL + A	Enlarges displayed menus
RF ON/OFF	CTRL + R	Switches the RF output signal on/off. "RF OFF" is indicated in the status line.
SETUP	CTRL + E	Opens the setup menu for general instrument settings.
WINBAR	CTRL + W	Toggles between the active menus.

4.8.1 Front Panel Key Emulation

The R&S SMA provides a front panel key emulation to enable execution of the front panel key functions by mouse e.g. for remote access. The emulation is called by a right mouse click. The front panel key functions are executed by a mouse click on the associated button.

Freq	Diagram
Level	Menu
File	Rearr.
RF On/Off	WinBar
Mod On/Off	Help
Preset	
Local	
Setup	
Hardcopy	
Info	

5 Instrument Function

5.1 Overview of Instrument Functions

This chapter explains the functions of the R&S SMA and the options available in the setting menus. The associated SCPI command is specified for each parameter (where applicable).

The description starts with the general instrument settings which do not directly affect signal generation. The majority of these settings can be accessed by means of front-panel softkey menus and not by means of function block menus.

The signal generation functions are then described, beginning with the functions which affect the RF signal ("RF" block) and the analog modulations ("Mod" block). The configuration of the modulation generators (LF generators and pulse generator) and of the LF sweep is offered in the "Mod Gen" block. The clock synthesis signal is set in the "Clock Synthesis" block.

The general instrument settings include various functions, such as:

- Setting a defined basic setup using the PRESET key
see [chapter 5.2.2, "Default Instrument Settings - Preset Key"](#), on page 81
- Switching from remote control to manual control using the LOCAL key
see [chapter 5.2.4, "Switching to Manual Control - Local Key"](#), on page 103
- Configuring the generator and its interfaces in the "Setup" dialog - e.g. setting the GPIB address, starting an adjustment, querying instrument data
see [chapter 5.2.3, "General Configuration of Instrument - Setup Key"](#), on page 82
- Calling up the online help using the HELP key
see [chapter 5.2.7, "Help System - Help Key"](#), on page 107
- Querying messages using the INFO key
see [chapter 5.2.6, "Messages - Info Key"](#), on page 107
- Loading and storing complete instrument settings in the "File" menu
see [chapter 5.2.8, "Storing and Loading Instrument Data - File Key"](#), on page 108

The RF signal and the reference oscillator are configured in the "RF" function block:

- CW mode
see [chapter 5.3.1, "Overview of RF Signal"](#), on page 114
- List mode
see [chapter 5.3.7.4, "List Mode"](#), on page 202
- Frequency and Level Sweep mode
see [chapter 5.3.7.1, "Overview"](#), on page 189
- Reference Oscillator
see [chapter 5.3.4, "Reference Oscillator"](#), on page 124
- RF Level
see [chapter 5.3.5.1, "Overview of RF Level"](#), on page 127
- RF Level Sweep

- see [chapter 5.3.7.3, "RF Level Sweep"](#), on page 196
- ALC
see [chapter 5.3.5.4, "Automatic Level Control - ALC"](#), on page 132
- Power Sensors
see [chapter 5.3.6.1, "Power Sensors"](#), on page 145
- User Correction
see [chapter 5.3.5.6, "User Correction"](#), on page 138

The analog and external digital modulations are activated in the "Modulation" function block:

- Amplitude Modulation
see [chapter 5.4.2, "Amplitude Modulation \(AM\)"](#), on page 215
- Frequency Modulation
see [chapter 5.4.3, "Frequency Modulation \(FM\)"](#), on page 218
- Phase Modulation
see [chapter 5.4.4, "Phase Modulation \(PhiM\)"](#), on page 223
- Pulse Modulation
see [chapter 5.4.5, "Pulse Modulation \(PM\)"](#), on page 229
- Chirp Modulation
see [chapter 5.4.6, "Chirp Modulation"](#), on page 231
- Test signals for avionic systems
 - see [chapter 5.4.7, "DME Modulation"](#), on page 236
 - see [chapter 5.4.8, "VOR Modulation"](#), on page 258
 - see [chapter 5.4.9, "ILS-GS Modulation"](#), on page 266
 - see [chapter 5.4.10, "ILS-LOC Modulation"](#), on page 272
 - see [chapter 5.4.11, "Marker Beacon Modulation"](#), on page 282
 - see [chapter 5.4.12, "ADF Modulation"](#), on page 287

The internal LF generators, the LF frequency sweep and the pulse generator are configured in the "Mod Gen" function block:

- LF Frequency Sweep
see [chapter 5.5.2, "LF Frequency Sweep"](#), on page 292
- LF output
see [chapter 5.5.3, "LF Output"](#), on page 297

The clock synthesis is configured in the "Clock Synthesis" function block:

- see [chapter 5.6, "Clock Synthesis"](#), on page 311

5.2 General Instrument Settings

5.2.1 Overview of General Instrument Settings

This section describes the settings which do not directly affect signal generation. Most of these settings can only be accessed by means of menus which are opened using keys or key combinations on the external keyboard or keys on the front panel key emulation.

The general instrument settings therefore affect various functions, such as storing instrument settings using the FILE key or setting the GPIB address in the menu of the SETUP key. The order in which the descriptions are given corresponds to the layout of the keys on the front panel of the R&S SMA (from top left to bottom right).

5.2.2 Default Instrument Settings - Preset Key

The PRESET key calls up a defined instrument setup. All parameters and switching states are preset (also those of inactive operating modes). The default instrument settings provide a reproducible initial basis for all other settings.

However, functions that concern the integration of the instrument into a measurement setup are not changed, e.g. GPIB address or reference oscillator source settings.

When the instrument is switched on, it is not the preset state that is active, but rather the instrument state that was set before the instrument was switched on.

An exception is the state of the RF output. The state of the RF output power-on state can be set to be always off in the "EMF" menu of the "RF" block.

User-defined instrument states can be stored and called up in the "File" menu.



Resetting the instrument to the factory state is possible with the [Factory Preset](#) function.

Preset

Presets all parameters and switching states.

The following list gives an overview of the presets for the most important generator settings. The other presets can be found in the preset tables of the individual menus and the information accompanying the remote commands.

- "RF frequency" = 1 GHz
- "RF level" RF output switched off
- "Offsets" = 0
- "Modulations State" = Off
- Uninterrupted level settings are switched off
"Level Attenuator Mode" = AUTO
- Internal level control "Level ALC" = AUTO
- User correction "Level Ucor" = OFF
- "LF output State" = Off
- "Sweep State" = Off

- "List mode State" = Off

Settings that are not affected by the PRESET key

- Reference frequency settings ("Ref Oscillator" menu)
- Power on settings ("Level/EMF" menu)
- Network settings ("Setup" menu)
- GPIB address ("Setup" menu)
- *IDN? Identification and emulation ("Setup" menu)
- Password and settings protected by passwords ("Setup" menu)
- Start/Stop Gui Update ("Setup" menu)
- Display and keyboard settings ("Setup" menu)

SCPI command:

*RST on page 357

5.2.3 General Configuration of Instrument - Setup Key

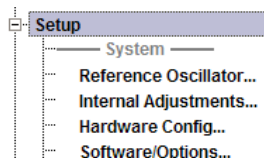

The SETUP key opens the "Setup" dialog.

The "Setup" dialog is divided into several sections.

- The "System" section is used to set general instrument parameters.
- The "Test" section is used to perform function tests.
- The "Environment" section is used to configure the controller interfaces.
- The "Remote" section is used to configure the remote control interfaces.
- The "Protection" is used to set the protection level for service functions and security settings.
- The "Settings" section is used to save or recall instrument settings or to preset the instrument to factory settings.

Most submenus of this key can be accessed only via the SETUP key or the menu tree (MENU key), with the following exceptions:

- The "Reference Oscillator" dialog can also be called up in the "RF" block and is therefore described in the section on this block (see [chapter 5.3.4, "Reference Oscillator"](#), on page 124).
- The "Save/Recall" dialog can also be called up with the FILE key and is therefore described in the section on this key (see [chapter 5.2.8, "Storing and Loading Instrument Data - File Key"](#), on page 108).

5.2.3.1 Internal Adjustments

The R&S Signal Generator is extremely accurate thanks to the integrated procedures for adjustments.

All internal adjustments for which no external measuring equipment is needed can be started in the "Internal Adjustments..." dialog. The adjustments with external measuring equipment are described in the Service Manual (on CD ROM, supplied with the instrument).

Adjustment is recommended if the temperature range in which the instrument is operated changes, or prior to all applications which require maximum level and frequency accuracy.

During adjustment a bar indicates the status of progress. If an error occurs, adjustment is terminated and an error message is output in the info line.

NOTICE

Risk of invalid adjustment

In order to achieve correct adjustment of the instrument, make sure that the instrument is warm before performing adjustments. The warm-up time is 30 minutes.

NOTICE

Risk of damage to the DUT

High power at the RF output may destroy a connected DUT (**D**evice **U**nder **T**est).

During level adjustments instruments without step attenuator, i.e. with frequency options R&S SMA-BxxxL, temporarily apply high power at the RF output. This may damage the DUT. Therefore, it is required that the RF connector is terminated during adjustment.

Disconnect the DUT and replace it by a 50 Ohm terminating resistor.

To access the "Internal Adjustments" dialog, press the SETUP or MENU key under "System".

The adjustments offered also depend on the installed options.

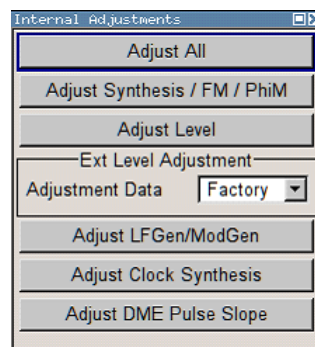

Adjust All

Starts all internal adjustments for which no external measuring equipment is needed. The adjustments with external measuring equipment are described in the Service Manual (supplied).

SCPI command:

`:CALibration:ALL[:MEASure]?` on page 361

Adjust Synthesis

Performs all adjustments which affect the frequency.

This includes adjustment of following options:

- R&S SMA-B20, FM/PhiM Modulator
- R&S SMA-B22, Enhanced Phase Noise Performance and FM/PhiM Modulator
- R&S SMA-B106/106L, Frequency Extension 6GHz with/without attenuator.

SCPI command:

`:CALibration<hw>:FREQuency[:MEASure]?` on page 362

Adjust Level

Performs all adjustments which affect the level. The acquired correction values improve the settling time and the signal quality.

SCPI command:

`:CALibration<hw>:LEVel[:MEASure]?` on page 362

Adjustment Data

Selects the data used for external level correction.

By default the instrument uses correction data obtained in the factory before delivery. In addition, customer data can be used for external level correction. The customer data is obtained using a R&S NRP power sensor. External level correction is a protected function (see Service Manual, chapter 2, "Adjustment").

SCPI command:

`:CALibration<hw>:LEVel:EXtern:DATA` on page 362

Adjust LF Gen/Mod Gen

Performs all adjustments which affect the internal modulation generator.

SCPI command:

`:CALibration:LFOutput[:MEASure]` on page 363

Adjust Clock Synthesis

Performs all adjustments which affect the clock synthesis.

SCPI command:

`:CALibration:CSYNthesis[:MEASure]?` on page 361

Adjust DME Pulse Slope

Activates internal adjustment of the DME pulse slope for best linearity.

SCPI command:

`:CALibration:DME[:MEASure]?` on page 361

5.2.3.2 Hardware Config

In the "Hardware Config" dialog, the installed assemblies together with their variants and revision states can be displayed for servicing purposes.

To open the "Hardware Config" dialog, select "System" and press the SETUP or MENU key.

Counter		
Operation Time / h	187 500	
Power On Count	187 500	
Common Assembly		
Assembly	Part Number	Revision
SMA100A	1400.0000k02	---
Motherboard	1141.3501.00	00.00
IBoard	1400.0517.00	00.00
COM-FPGA		00.00.00
RF Assembly		
Assembly	Part Number	Revision
SSyn	1141.4008.00	00.00
SynEx	1142.0070.00	00.00
CwOp3	1400.1707.00	00.00
SAtt3C	1161.2123.00	00.00

Section "Counter" in the upper part of the menu shows the "Operation Time" (in hours) and the number of power-on ("Power On Counter").

The second part of the menu is a table that lists the installed assemblies. It is divided into the sections:

- "Common Assembly"
- "RF Assembly"

Operation Time / h

Displays the operation time in hours.

SCPI command:

`:DIAGnostic:INFO:OTIME?` on page 367

Power On Count

Displays the number of power-on.

SCPI command:

`:DIAGnostic:INFO:POCount?` on page 367

Assembly

The tables list the installed assemblies.

"Assembly" Assembly name
 "Part Number" Part Number of assembly
 "Revision" Revision state of assembly

SCPI command:

`:DIAGnostic<hw>:BGInfo?` on page 366

5.2.3.3 Software / Options

The "Software/Options" dialog shows the firmware version of the instrument software as well as all installed hardware and software options.



Software options purchased at a later stage can be activated with a keycode. The activation code is supplied with the software option. How to install options is described in Chapter 4 of the Service Manual (supplied with the instrument).

The installation of hardware options purchased at a later stage is also described in Chapter 4 of the Service Manual (supplied with the instrument). Most hardware options need to be installed at an authorized Rohde&Schwarz service shop.

To access the "Software/Options" dialog, select "System" and press the SETUP or MENU key.

The menu is divided into the following sections:

- "Firmware"
- "Hardware Options"
- "Software Options"

Package	More...
SMA100A FW	2.05.68.04 beta (Releas..
R&S COMPASS	2.2.2.3 (Release)

Firmware

The Firmware section of the menu shows the firmware version and the version of the software platform.

Note: Your instrument is delivered with the latest firmware version available. Firmware updates as well as the Release Notes describing the improvements and modifications are provided on the Internet at the download site of the Rohde & Schwarz Signal generator home page. This home page always offers the latest information on your signal generator, e.g. also on changes of the firmware update procedure.

SCPI command:

n.a.

Hardware Options / Software Options

The tables in the sections "Hardware" and "Software" list the installed hardware and software options.

"Option" Short name of option

"Designation" Name of Option

SCPI command:

*OPT? on page 356

*IDN? on page 355

Loaded Modules

Section "Loaded Modules" is provided for service purposes. It lists all loaded software modules with their versions and offers a short description of each module.

SCPI command:

n.a.

5.2.3.4 Manage License Keys

This dialog is the central dialog for managing licenses, like enabling newly purchased and/or newly registered options or performing the required instrument related steps during the process of unregistration of licenses.

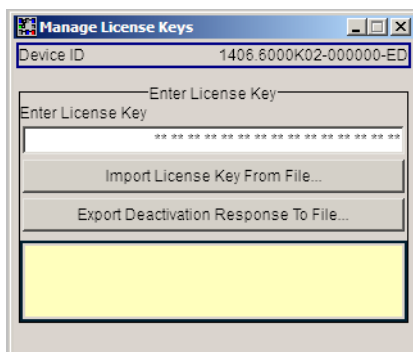

An option is ready to operate after it is enabled by means of a license key code supplied with the option. The license key is delivered as a file or on paper. Unregistered licenses must be registered for a particular instrument prior to the corresponding option can be enabled for operation.



License Registration

If your purchased license is delivered unregistered, you must register it before you can activate the option.

For detailed information about the license registration, refer to the installation instructions provided with the option (Supplement A) and the documentation of the online tool "Manage Licenses" (<https://extranet.rohde-schwarz.com/service>).



Only if the R&S Signal Generator is equipped with an older firmware version, a firmware update prior to enabling the software option may be required. The information on the valid firmware versions for the purchased software option is provided together with the option. The firmware update is described in the service manual, chapter 4 (on CD ROM, supplied with the instrument).

Device ID

Displays the instrument specific identification number. The device ID is an unique string with the following structure:

```
<stock number>-<serial number>-<checksum>
```

Enter License Key

Type here the license key provided with the option.

For license keys delivered as a file, use [Import License Key from File...](#)

Import License Key from File...

Opens a dialog for selecting the file with the license key.

Export Deactivation Response to File...

Exports the generated deactivation response key to a file and opens a file management dialog to save the file. This key is required during the unregistration process.

Status Information

Displays status information.

5.2.3.5 Gui Update

The "Start/Stop Gui Update" dialog provides the possibility to switch off update of the displayed parameters in order to increase speed for certain settings.

The indicated values are not updated and may therefore differ from the intern, used values.

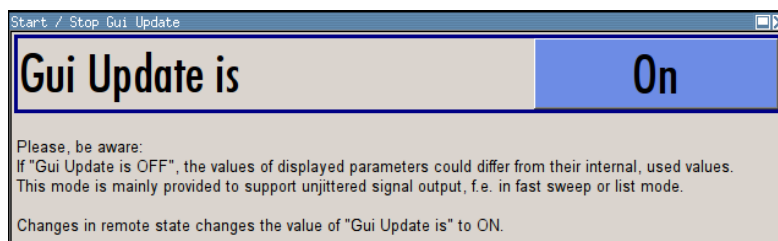
**On/Off GUI Update**

Switchs on/off update of the displayed parameters.

Switching off the update of the displayed parameters increases the speed for certain settings.

Note: It is especially recommended to switch off the GUI update for optimum sweep performance with short dwell times and for fast settling times.

SCPI command:

:SYSTEM:DISPlay:UPDate on page 626

5.2.3.6 NRP-Z Info/Update

In the "NRP-Z Info/Update..." dialog, the connected power sensors are indicated together with their serial number, revision state and features in terms of support of the R&S SMA-K28 Power Analysis option. The software of a connected sensor can be updated to a new version.

To access the "NRP-Z Info/Update..." dialog, select "System" and press the SETUP or MENU key.

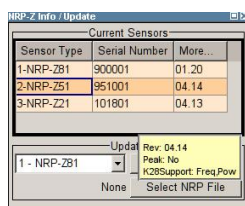

Current Sensors

Section "Current Sensors" lists the sensors that are connected to the generator and indicates their serial number, the revision state and some features.

Tip: Click on a sensor to get quick information about the firmware version and whether this sensor measures the peak of the signal.

"K28Support" indicates the R&S SMA-K28 measurement functions provided by the sensor.

SCPI command:

`SENSe<ch>[:POWER]:TYPE?` on page 437

`SENSe<ch>[:POWER]:SVERsion?` on page 406

`SENSe<ch>[:POWER]:SNUMber?` on page 405

Update

Section "Update" provides access to the file system in order to select a file for an R&S NRP sensor update (Button "Select NRP File"), the selected file is indicated to the left of the button. On the left side, the sensor to be updated is selected.

Button "Run Update" starts the update. If the update is interrupted for example by accidentally pulling off the sensor, selection "Rescue" is offered to restart the update process. Prerequisite is that no other sensor is connected to the instrument.

The procedure is as follows:

- Do not reconnect the sensor but keep it ready to be connected
- Select "Rescue" in the left sensor selection field
- Activate "Run Update"
- Confirm query in message box
- Connect sensor within 4 seconds

The update starts, a bar informs about the progress.

SCPI command:

n.a.

5.2.3.7 Update

After a firmware update it is occasionally required to also update the "PCI-FPGA". This is enabled in the "Update" dialog.

At the first start of the new firmware, a message appears during the boot process if a "PCI-FPGA" update is required. Execute a PCI-FPGA update by pressing the "PCI-FPGA" button.

NOTICE

Impairment of instrument functions

To avoid impairment of instrument functions, the update of the "PCI-FPGA" must not be cancelled and the instrument must not be switched off during this update.

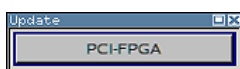

5.2.3.8 Selftest

A selftest is provided for service purposes. The selftest is a protected test procedure, which can be accessed if protection level 1 is disabled. The protection dialog is called in the "Setup" menu (see [chapter 5.2.3.14, "Protection"](#), on page 97).

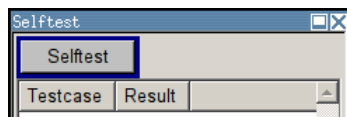

The following tests are only available via remote control:

- `:TEST<hw>:DIRect` on page 633

Selftest

Performs a selftest on all installed hardware options.

A list of the performed tests cases and the result of each of them (passed or failed) is displayed.

SCPI command:

`:TEST<hw>:ALL:START` on page 633

`:TEST<hw>:ALL:RESult?` on page 633

5.2.3.9 Check Front Panel

The "Check Front Panel" dialog is used to check whether the front panel keys are functioning correctly. The menu displays all the front panel keys arranged in the same way as on the front panel. The respective function is executed by pressing the associated key.

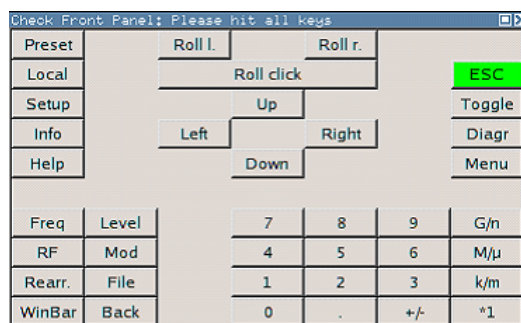

5.2.3.10 Date and Time

The "Date/Time..." dialog provides access to the system time and date settings. It is opened using the SETUP or MENU key under "Environment". The time is used on the internal controller.

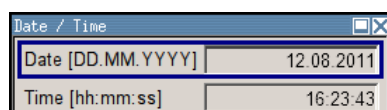



To prevent accidental changes, "Date" and "Time" are protected functions. They can be accessed with protection level 1, see [chapter 5.2.3.14, "Protection"](#), on page 97.

Date

Indicates the date in the format day.month.year.

In order to prevent accidental changes, this parameter is protected. It can be accessed with protection level 1, [chapter 5.2.3.14, "Protection"](#), on page 97.

SCPI command:

:SYSTem:DATE on page 626

Time

Indicates the time in the format hour.minute.second

In order to prevent accidental changes, this parameter is protected. It can be accessed with protection level 1, see [chapter 5.2.3.14, "Protection"](#), on page 97.

SCPI command:

:SYSTem:TIME on page 632

5.2.3.11 Network Settings

The "Network Settings" dialog provides access to the network settings. To access this dialog, press the SETUP or MENU key under "Environment". The R&S SMA is equipped with a network interface and can be connected to an Ethernet LAN (local area network).

How to connect the signal generator to the network is described in [chapter 2.6.1, "Connecting the Instrument to the Network"](#), on page 34.

NOTICE

Risk of network errors!

Connecting errors may affect the entire network.

We recommend to coordinate the connection of the instrument to the network with the network administrator.

Do not connect or disconnect the network cable until the instrument is **switched off** (standby). Only then the network connection can be reliably detected and impairments to instrument operation can be avoided.

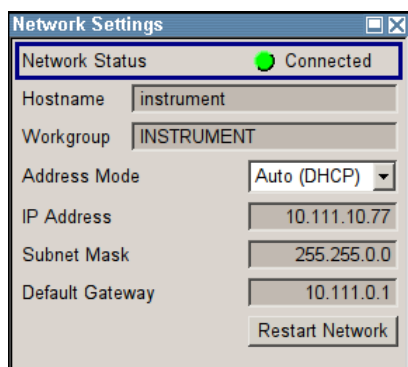

The dialog provides an access to the network settings, like settings about the general network environment and specific identification of the computer in the network, as well as an indication whether the instrument is connected to the network or not.

Network Status

Indicates whether the instrument is connected to the network or not.

SCPI command:
n.a.

Hostname

Enters the individual computer name of the R&S Signal Generator.

Note: The computer name can only be changed after protection level 1 is deactivated (see [chapter 5.2.3.14, "Protection"](#), on page 97).

A predefined name is indicated and can be used for network connections.

SCPI command:

`:SYSTEM:COMMunicate:NETWork[:COMMON]:HOSTname` on page 622

Workgroup

Enters the individual windows workgroup name of the R&S Signal Generator. This parameter is necessary in case the instrument is integrated in a windows network.

Note: The workgroup can only be changed after protection level 1 is deactivated (see [chapter 5.2.3.14, "Protection"](#), on page 97).

SCPI command:

`:SYSTEM:COMMunicate:NETWork[:COMMON]:WORKgroup` on page 622

Address Mode

Selects if the IP address is assigned automatically or manually.

"Auto (DHCP)" The IP address is assigned automatically.
The network used must support automatic assignment of IP address via DHCP or APIPA (Zeroconf) in order to use this function.

"Static" The IP address is assigned manually.

SCPI command:

`:SYSTEM:COMMunicate:NETWork:IPAddress:MODE` on page 622

IP Address

Displays the IP address. To enter the IP address manually, select "Static" Address Mode.

SCPI command:

`:SYSTem:COMMunicate:NETWork:IPADdress` on page 623

Subnet Mask

Displays the Subnet mask. To enter the Subnet mask manually, select "Static" Address Mode.

This number is used together with the IP address to identify the network segment the instrument is in.

SCPI command:

`:SYSTem:COMMunicate:NETWork[:IPADdress]:SUBNet:MASK` on page 623

Default Gateway

Displays the IP address of the default gateway. To enter the default gateway manually, select "Static" Address Mode.

This address identifies the router on the same network as the instrument that is used to forward traffic to destinations beyond the local network.

SCPI command:

`:SYSTem:COMMunicate:NETWork[:IPADdress]:GATeway` on page 623

Restart Network

Shuts down the network connection of the instrument and subsequently re-establishes the connection.

This function can be used to resolve network problems.

Note: Only the connection of the instrument to the network restarts, the network itself is not affected.

SCPI command:

n.a.

5.2.3.12 Display/Keyboard Settings

In the "Display/Keyboard Settings" menu the power-save mode and external keyboard settings are made. It is opened using the SETUP or MENU key under "Environment".

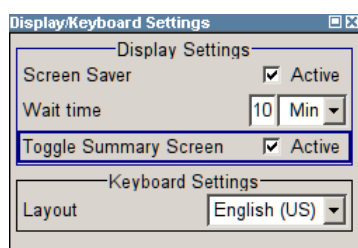
**Screen Saver Active**

Activates/deactivates the screen-save mode of the display.

If activated, the display including backlight is completely switched off after the elapse of the "Wait Time" when no entries via front panel, external mouse or external keyboard are made.

This mode is recommended for preserving the display especially if the instrument is exclusively operated via remote control.

SCPI command:

`:DISPlay:PSAVe[:STATe]` on page 370

Wait Time

Enters the idle time that must elapse before the display lamp is shut off when no entries are made.

SCPI command:

`:DISPlay:PSAVe:HOLDoff` on page 369

Toggle Summary Screen

Activates/deactivates the magnified frequency and level indication. If activated, the frequency and level indication covers the complete display.

SCPI command:

n.a.

Layout (Keyboard)

Selects the keyboard layout for the selected keyboard language.

The assignment of some keys depends on the selected layout and language.

SCPI command:

`:KBOard:LAYout?` on page 379

`:KBOard:LANGuage` on page 379

5.2.3.13 Remote Channel Settings

The "Remote Channel Settings" dialog provides access to the settings for remote control. The dialog is opened using the SETUP or MENU key under "Remote".

Besides the standard GPIB-setting, the selection of one of the possible emulations and a user defined definition of the *IDN and *OPT string is possible.

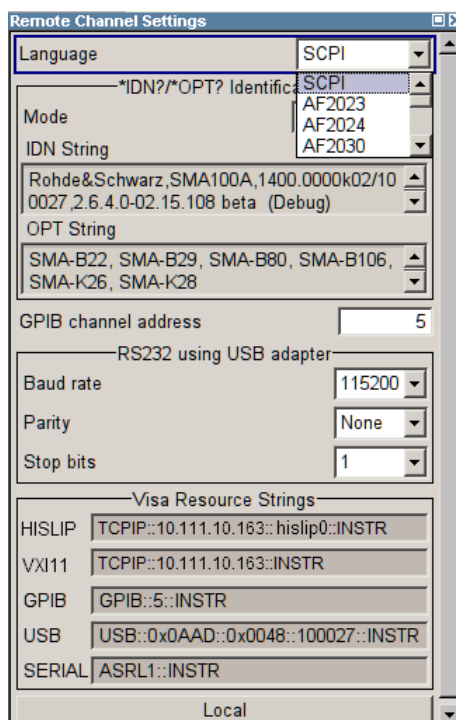

Language

Selects the instrument whose remote command set is emulated by the R&S SMA.

The R&S SMA can also be remote controlled via the command set of several other generators, e.g. of an HP generator. You find the available command sets for the generator in the selection list. This feature allows to replace a generator by an R&S SMA in existing test setups. Refer to the corresponding Application Note at the download area of the product site on the Internet. The Application Note is also provided on the user documentation CD-ROM (included in delivery).

The selected instrument also defines the identification string that is retrieved with query `*IDN?`. If required, use the parameter "Mode" and "IDN String" to change this string.

As any other parameter, the remote control command set can also be changed remotely by means of the SCPI command `SYST:LANG`. However, this remote control command is enabled only in the instrument's specific SCPI command set, i.e. it is possible to change the command set remotely from the original one (`SYST:LANG SCPI`) to the command set to be emulated but not vice versa.

Note: While working in an emulation mode, the R&S SMA specific command set is disabled, i.e. the SCPI command `SYST:LANG` will be discarded.

To return to the SCPI command set of the R&S SMA, use the appropriate command of the selected command set. If for example a HP generator is emulated, the HP command `EX` returns to the instrument-specific GPIB command set.

SCPI command:

`:SYSTem:LANGuage` on page 630

Identification Mode

Selects the way the instrument identification is performed.

"Automatic" The "IDN String" and the "OPT String" are set automatically for the instrument select with the parameter "Language".

"User Defined" Enables the selection of user definable "IDN String" and "OPT String" for the instrument selected with the parameter "Language".

SCPI command:

[:SYSTem:IDENtification](#) on page 629

Set to default

Overwrites the user-defined *IDN and *OPT strings with default strings.

The default strings vary depending on the selected emulation mode ([Language](#))

SCPI command:

n.a.

IDN String

Indicates the identification string of the instrument when queried with the common command *IDN?.

In addition to the preset values, a user defined identification string can be entered, e.g. to provide individual identification for each generator, like 'MY_R&S SMA' for instance.

SCPI command:

*IDN?

OPT String

Indicates the option string of the instrument as queried with common command *OPT?.

If a "User Defined" [Identification Mode](#) is selected, a user defined option string can be created, additionally to the automatically created one.

SCPI command:

*OPT?

GPIB channel address

Sets the GPIB address of the instrument.

SCPI command:

[:SYSTem:COMMunicate:GPIB\[:SELF\]:ADDRess](#) on page 621

RS232 using USB adapter

Requires a USB serial adapter (recommended extra, see data sheet)

Sets the parameters of the serial interface.

Either a RS232 interface or a Bluetooth connection can be used for remote control via the serial interface. The settings are effective for both interfaces (see also [chapter 5.2.3.15, "Security"](#), on page 98).

SCPI command:

[:SYSTem:COMMunicate:SERial:BAUD](#) on page 625

[:SYSTem:COMMunicate:SERial:PARity](#) on page 625

[:SYSTem:COMMunicate:SERial:SBITs](#) on page 625

Visa Resource Strings

Indicates the visa resource strings, used for remote control of the instrument. A separate string is provided for remote control via the different interfaces.

SCPI command:

:SYSTem:COMMunicate:HISLip:RESource on page 621
 :SYSTem:COMMunicate:NETWork:RESource on page 624
 :SYSTem:COMMunicate:SOCKet:RESource? on page 625
 :SYSTem:COMMunicate:GPIB:RESource? on page 624
 :SYSTem:COMMunicate:USB:RESource? on page 624
 :SYSTem:COMMunicate:SERial:RESource? on page 624

Local (Remote Channel Settings)

Switches the instrument to operate in local control mode.

Switching from remote to local control mode can be also done with one of the following actions:

- manually with the LOCAL key on the front panel
- with the interface command >L via the remote-control interface
- with the key combination CTRL + Q.

SCPI command:

>L

5.2.3.14 Protection

This "Protection" dialog provides access to the unlocking of different protection levels. To open this dialog, use the SETUP or MENU key under "Protection".

After the instrument has been switched on, the protection levels 1 to 5 are automatically activated. To deactivate the protection, the correct password has to be entered. With the corresponding check boxes, you can activate the protection again.

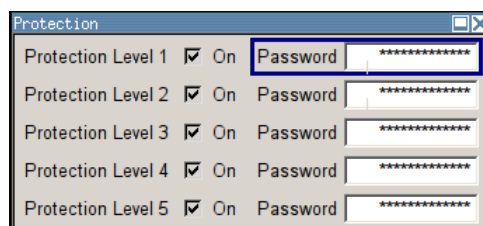

The following functions are protected in the respective levels:

- Protection Level 1
protects against accidental changes to certain settings, such as clock and date, network settings or instrument names, etc. This level is accessible to the user.
- Protection Level 2
provides access to the unlocking of protected service functions. It is accessible to authorized personnel of R&S Service Departments only.
- Protection Level 3-5
are reserved for factory internal use.

Protection Level/Password

Protection Level 1 can be activated to expand the functionality of the internal adjustment and to access the selftests.

The password is 123456.

SCPI command:

`:SYSTEM:PROTECT<ch> [:STATE]` on page 630

5.2.3.15 Security

The "Security" dialog provides access to the passwords and mass storage security settings. To open this menu, use the SETUP or MENU key under "Protection".

The menu is divided into the password sections and the security settings section. In the password section, the passwords for securing a controlled access to the instrument are defined and changed.

A change of passwords for the operating system and security password requires the entry of the old and new password and the conformation of the new password. All settings are only accepted after the "Change Password" button is pressed.

User Name

Indicates the user name used for access to the Linux operating system and valid for VNC, FTP and SAMBA access.

The user name and password are required for remote access to the instrument via VNC, FTP or SAMBA.

SCPI command:

n.a.

Old Password (User Password)

Enters the currently used user password. The default password is "instrument".

Note: It is highly recommended to change the default user password before connecting the instrument to the network.

New Password (User Password)

Enters the new security password.

The security password may contain decimal characters only.

SCPI command:

n.a.

Confirm Password (User Password)

Enters the new password for conformation.

The new password is only valid after the "Change Password" button is pressed.

SCPI command:

n.a.

Change Password (User Password)

Changes the password accordingly.

SCPI command:

n.a.

Old Password (Security Password)

Enters the currently used security password. The default password is '123456'.

Note: It is highly recommended to change the default security password before connecting the instrument to the network.

The security password is required when changing the status of the USB and LAN interface.

SCPI command:

n.a.

New Password (Security Password)

Enters the new security password.

The security password may contain decimal characters only.

SCPI command:

n.a.

Confirm Password (Security Password)

Enters the new password for conformation.

The new password is only valid after the "Change Password" button is pressed.

SCPI command:

n.a.

Change Password (Security Password)

Changes the password accordingly.

SCPI command:

n.a.

LAN Services

Opens the "LAN Services" dialog for individually enabling or disabling the available LAN interface services.

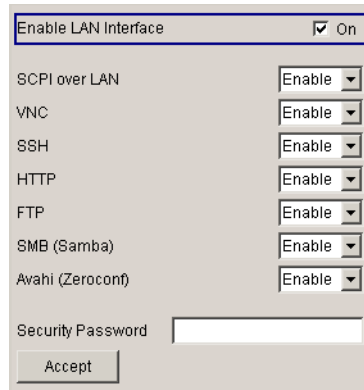
**Enable LAN Interface ← LAN Services**

Enables the LAN interface in general, and thus provides remote access via all unlocked services.

The settings in this dialog require the entry of the [Security Password](#), and are only accepted after the [Accept - Security](#) button is pressed.

Enable LAN Services individually ← LAN Services

Enables or disables the following interface services individually.

"SCPI over LAN"

activates access over LAN to remotely control the instrument using SCPI (**S**tandard **C**ommands for **P**rogrammable **I**nstruments) commands.

"VNC"

activates access via VNC (**V**irtual **N**etwork **C**omputing) interface, a graphical desktop sharing system that uses RFB protocol to remotely control the instrument.

"SSH"

activates access via SSH (**S**ecure **S**hell), a network protocol for secure data communication.

"HTTP"

activates access via HTTP (**H**yper **T**ext **T**ransfer **P**rotocol), the application protocol for hypermedia information systems.

"FTP"

activates access via FTP (File Transfer Protocol), used to transfer files from a host to the instrument and vice versa.

"SMB (Samba)"

activates access to SMB (**S**erver **M**essage **B**lock), used for providing shared access to files, printers and serial ports of a network.

"Avahi (Zeroconf)"

activates Avahi, a service for automatic configuration of the instrument in a network environment.

SCPI command:

n.a.

USB Storage

Activates the access to external USB storage media.

This setting has no effect on a mouse or a keyboard, connected via USB.

The setting requires the entry of the security password and is only accepted after the "Accept" button is pressed.

SCPI command:

n.a.

Annotation Frequency

Enables/disables the display of the currently used frequency in the header of the instrument.

The setting requires the entry of the security password and is only accepted after the "Accept" button is pressed.

SCPI command:

[:DISPlay:ANNotation:FREQuency](#) on page 368

Annotation Amplitude

Enables/disables the display of the currently selected level in the header of the instrument.

The setting requires the entry of the security password and is only accepted after the "Accept" button is pressed.

SCPI command:

[:DISPlay:ANNotation:AMPLitude](#) on page 368

Display

Enables/disables the display.

If this parameter is disabled, the instrument cannot be operated manually via the user interface, i.e. display, front panel keys and external keyboard are disabled. Remote control of the instrument is enabled.

The setting requires the entry of the security password and is only accepted after the "Accept" button is pressed.

SCPI command:

[:SYSTem:DLOCK](#) on page 626

Keyboard

Enables/disables an external keyboard and mouse connected to the instrument, the front panel keys of the instrument, the rotary knob and the on-screen keyboard.

If this parameter is disabled, the instrument cannot be manually controlled but changes in the settings are shown on the display. Remote access and remote control are enabled.

The setting requires the entry of the security password and is only accepted after the "Accept" button is pressed.

To enable the keyboard, type the security password on the external keyboard or use the `SYST:KLOC OFF` command over remote control.

SCPI command:

`:SYSTem:KLOCK` on page 629

Security Password

Enters the password that is required to enable or to disable the settings protected by a security password. Default is '123456'.

Note: It is highly recommended to change the default security password before connecting the instrument to the network.

All settings are only accepted after the "Accept" button is pressed.

SCPI command:

n.a.

Accept - Security

Accepts a new entry or selection and changes the settings accordingly.

SCPI command:

n.a.

Bluetooth Pin

Requires a USB Bluetooth adapter (recommended extra, see data sheet).

Enters the Bluetooth pin of an external Bluetooth device. The pin is required to enable remote control via an external Bluetooth device.

The interface parameters are identical to the RS232 interface parameters and can be set in the "Remote Channel Settings" dialog (see ["RS232 using USB adapter"](#) on page 96).

SCPI command:

n.a.

5.2.3.16 Save/Recall

The "Save/Recall" submenu can also be called up with the FILE key and is therefore described in the section of this key (see [chapter 5.2.8, "Storing and Loading Instrument Data - File Key"](#), on page 108).

5.2.3.17 Factory Preset

The "Factory Preset" dialog provides a function to reset the instrument's settings to their factory state. This function is activated by pressing the "Execute Factory Preset" button.

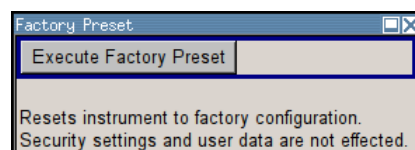

Factory Preset

Reset the instrument's settings to their factory state.

Note: Since Factory Preset resets the Remote Channel and network settings to the default values, executing Factory Preset via remote control terminates the connection to the instrument, if these settings had been configured to values different to the default ones!

The factory preset function resets nearly all instrument settings. In addition to the regular preset by means of the PRESET key, a "Factory Preset" resets also the following values:

- Reference frequency settings ("Ref Oscillator" menu)
- Power on settings ("Level/EMF" menu)
- Network settings including hostname ("Setup" menu)
- Remote Channel settings including GPIB address ("Setup" menu)
- Start/Stop Gui Update ("Setup" menu)
- Display and keyboard settings ("Setup" menu).

To maintain security, password settings and all settings protected by these passwords like disabled USB and LAN connections are not changed.

Not affected by the "Factory Preset" are also user data, lists or instrument settings files, created for example by means of the Save/Recall function.

SCPI command:

:SYSTem:FPReset on page 360

5.2.3.18 Help

The "Help" dialog offers comprehensive online help for the R&S Signal Generator. A desired topic can be selected via the table of contents (select "Manual") or the index (select "Index").

For context-sensitive information about a marked parameter, press the HELP key. For a description of the "Help" menu, refer to the section covering to the HELP key (see [chapter 5.2.7, "Help System - Help Key"](#), on page 107).

5.2.4 Switching to Manual Control - Local Key

In remote control mode a status message appears in the display header. The rest of the display remains unchanged and shows the current instrument status, i.e. the status which exists under the remote control settings. The instrument can be operated (e.g. menus can be opened). However, it is not possible to enter or change values.

The status message additionally indicates whether the LOCAL key is disabled or enabled.

If the "REMOTE" status message is shown, the LOCAL key switches the instrument from remote control to manual control. The current command must be fully processed before the mode is switched, otherwise the instrument switches immediately back to remote control.

If the "REM-LLO" status message is displayed, the instrument can be switched from remote control to manual control by means of remote control only (e.g. with the Visual Basic command `CALL IBLOC (generator%)`); the LOCAL key is disabled. The key is disabled by remote control with the command LLO.

When switching from remote to manual control, the display update suppression function, if active ("SETUP > GUI Update" is Off), is automatically deactivated ("SETUP > GUI Update" is On).

5.2.5 Generating a Hard Copy of the Display

The generation of a hardcopy of the display requires that an external keyboard is connected to the instrument. The hardcopy dialog is called with the key combination CTRL+Z or CTRL+Y depending on the used keyboard settings.

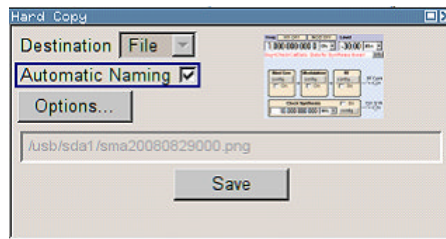

5.2.5.1 Hardcopy Dialog

Destination

Indicates that the hardcopy is stored in a file (see also "File Options" on page 105).

SCPI command:

`:HCOPY:DEVIce` on page 372

Options

Opens the Hardcopy Options dialog for configuring the hardcopy parameters (see "File Options" on page 105).

SCPI command:

n.a.

File

Some configuration parameters are already offered in the Hardcopy dialog. All configuration parameters are available in "File Options" on page 105.

Automatic Naming

Activates, deactivates automatic generation of the file name. Automatic naming is configured in the "Options..." submenu, see "File Options" on page 105.

SCPI command:

`:HCOPY:FILE[:NAME]:AUTO:STATe` on page 378

File Info

Indicates the file name. The file name can be entered either manually via the file manager (button "File...") or generated automatically (Automatic naming checkbox). Automatic naming is configured in the "Options..." submenu.

SCPI command:

`:HCOPY:FILE[:NAME]` on page 373

`:HCOPY:FILE[:NAME]:AUTO:FILE?` on page 375

5.2.5.2 Hardcopy Options

This section describes the "Hardcopy Options" dialog.

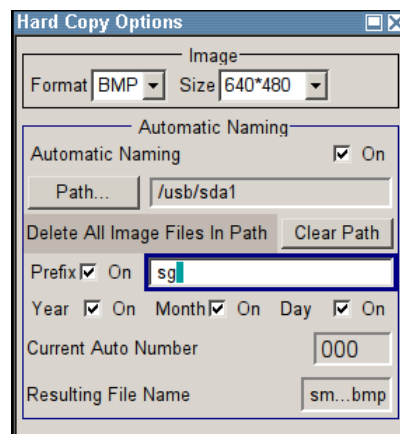
**File Options**

Dialog for setting the file parameters.

"Size" Defines the size of the bitmap in terms of pixels. The first value of the size setting defines the width, the second value the height of the image.

SCPI command:

`:HCOPY:IMAGe:SIZE` on page 378

"Format" Selects the image format. Several bitmap formats are available.

SCPI command:

`:HCOPY:DEVIce:LANGuage` on page 373

"Automatic Naming" Determines the rules to create the file names and sets the directory the files are saved into.

As default the automatically generated file name is composed of:

`<Path>/<Prefix><YYYY><MM><DD><Number>.<Format>`

Each component can be deactivated/activated separately to individually design the file name. The resulting file name is indicated.

"Path..." Opens the "Select Hard Copy Destination Path" dialog to select a path for storing the hardcopy.

Note: For selecting the destination path a file name must be entered as well. Otherwise the error message "The name of a list may not be empty" is displayed and the selection will be canceled.

Directory, path and file name are displayed in the infoline right to the "Path" button.

SCPI command:

`:HCOPY:FILE[:NAME]:AUTO:DIRectory` on page 374

`:HCOPY:FILE[:NAME]:AUTO?` on page 374

"Clear Path" Deletes all image files with extensions `bmp`, `img`, `png`, `xpm` and `csv` in the directory set for automatic naming.

Before deleting the image files a warning message is displayed requiring the confirmation.

SCPI command:

`:HCOPY:FILE[:NAME]:AUTO:DIRectory:CLEar` on page 374

"Prefix" Activates the usage of the prefix in the automatic file name. The prefix is entered in the field to the right of checkbox.

SCPI command:

`:HCOPY:FILE[:NAME]:AUTO[:FILE]:PREFix:STATe` on page 377

"Enter prefix" Enters the prefix for the automatically generated file name. The use of the prefix is activated in the checkbox to the left.

SCPI command:

`:HCOPY:FILE[:NAME]:AUTO[:FILE]:PREFix` on page 377

"Date - Year / Month / Day" Defines the components of the automatically generated file name. The selectable parameters are year, month and day. If activated the current year, month or day used in the file name.

SCPI command:

`:HCOPY:FILE[:NAME]:AUTO[:FILE]:YEAR:STATe` on page 377

`:HCOPY:FILE[:NAME]:AUTO[:FILE]:MONTH:STATe` on page 376

`:HCOPY:FILE[:NAME]:AUTO[:FILE]:DAY:STATe` on page 375

"Current Auto Number" Indicates the number which is used in the automatically generated file name.

Note: On initially switching on the device the number will be reset to the lowest possible value. Starting with number 0 the output directory will be scanned for already existing files. As long as files with the same name are existing the number will be increased by 1. The number will be automatically set to a number so that the resulting file name will be unique within the selected path. The current number will not be saved in the save recall file but will be temporarily stored within the database. On subsequent saves the number will be increased.

SCPI command:

`:HCOPY:FILE[:NAME]:AUTO[:FILE]:NUMBer?` on page 376

"Resulting File Name" Indicates the automatically generated file name.

SCPI command:

[:HCOPY:FILE\[:NAME\]:AUTO:FILE?](#) on page 375

Save

Triggers the generation of a hardcopy.

SCPI command:

[:HCOPY\[:EXECute\]](#) on page 373

5.2.6 Messages - Info Key

The INFO key opens a window containing a detailed description of every message displayed in the info bar, see [chapter 4.2.3, "Info Window"](#), on page 59 and [chapter 9, "Error Messages"](#), on page 647.

5.2.7 Help System - Help Key

The HELP key opens a browser window containing a context-sensitive description of the highlighted parameter.

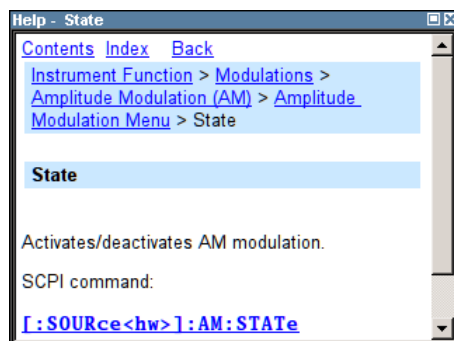

The context-sensitive page which is opened with the HELP key is part of a comprehensive help system. It is possible to move from this context-sensitive page to any page of the help system. The following navigation aids are available:

- Internal links in the text
They open pages which are directly linked to the described function. In this way it is possible, for example, to call up the description of the GPIB command for any particular function.
- Previous/Next links
The Previous/Next links allow scroll through the help pages. The sequence of the described functions corresponds to their position in the menus.
- Back button
The Back button calls up the page last viewed.
- Contents in the navigation panel

The contents list is used to open the individual help pages. It has a hierarchical structure. The highlighted line indicates where the currently displayed page is within the contents list.

- Index in the navigation panel
The index is used to call up all pages which contain the selected entry. The index has an alphabetical structure and also contains all GPIB commands.
- Find
The find function allows you to look for freely selectable terms in all help pages. A list of the pages containing the entered term is displayed as the search result. The search can be limited to words in the page title to increase the number of hits.

5.2.8 Storing and Loading Instrument Data - File Key

The R&S SMA allows complete instrument settings to be stored in files on the Compact-Flash™ Card.

Defined and complex instrument settings can then be reproduced at any time by loading this data. If required, these settings can be loaded to various signal generators.

The corresponding menu is available under "Save/Recall" in the "Setup" menu or accessible by means of the FILE key. The instrument settings are saved in files which can be stored in data directories.

Additionally there are intermediate memories in which the current instrument setting can be stored and then called up again by just pressing a key. This provides fast switching between different instrument settings.

Only settings which differ from the preset values and configuration data for the operating elements (e.g. window positions) are stored. As a result the files remain relatively small. Furthermore, instrument settings can easily be transferred between different equipped signal generators since the files contain only relevant information. When loaded, the referenced settings are implemented and all non-referenced parameters are set to the associated preset values.

If list data is part of the instrument settings, e.g. a list of user correction data, a reference to this list is stored, not the list itself. The list is reactivated when the associated settings are loaded, but the list may have been modified or deleted in the meantime or may not be available on a different instrument. If the list has been modified, the new entries will be used. An error message appears if an attempt is made to access a non-existing list or to activate settings which are not supported by the instrument.



- Network settings and remote settings are not saved and restored.
 - Lists are stored and loaded in the appropriate menus. For example, the user correction data list is created and stored in the "User Correction" menu.
-

When loading an instrument setting, it is possible to select whether the current frequency and level setting is to be retained or whether the stored settings are to be activated. It is possible to delete stored instrument settings. A file can be copied by loading it with "Recall" and then storing it under a new name.

Settings can be transferred easily between instruments with different equipment options and/or firmware versions because only the settings which differ from the preset values are affected. When settings are loaded, only those which are possible on the instrument are implemented. Error messages indicate the settings which cannot be implemented.

The stored file is transferred from one instrument to another using the memory stick.

General file management functions such as copying and moving data are available in the "File Manager" dialog.

5.2.8.1 File Menu

The settings available in the File menu "Save/Recall" depend on the operation selected under "Select Operation".



For more information, see [chapter 4.7.1, "File Select Dialog"](#), on page 73.

Select Operation

Selects the file function.

"Save..." Calls the menu for storing the current instrument setting (see [chapter 5.2.8.2, "Storing Instrument Settings"](#), on page 109).

"Recall..." Calls the menu for calling up a stored instrument setting (see [chapter 5.2.8.3, "Loading Instrument Settings"](#), on page 110).

5.2.8.2 Storing Instrument Settings

If "Save" is selected under "Select Operation", the File menu provides options for storing the current instrument setting in a file.

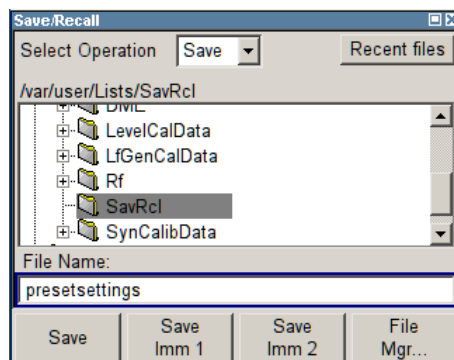

Recent files

Displays the files last used.

SCPI command:

n.a.

Directory

Selects the directory in which the file is to be stored.

The window opposite lists all settings files in this directory.

A new directory can be created in the "File Manager" dialog.

SCPI command:

`:MMEMemory:CDIRectory` on page 383

File List

Displays the files which are in the selected directory.

If a file is highlighted, it is overwritten when the file is stored.

SCPI command:

`:MMEMemory:CATalog?` on page 382

File Name

Enter the file name of the file without file extension. This file is then created.

SCPI command:

n.a.

Save

Stores the current instrument settings under the specified path.

SCPI command:

`*SAV` on page 357

`:MMEMemory:STORe:STATe` on page 387

Save Immediate x

Stores the current instrument setting in one of the three intermediate memories.

These instrument settings are retained until a different instrument setting is stored in the intermediate memory. When the instrument is switched off, the contents of the intermediate memories are retained.

SCPI command:

`*SAV` on page 357

File Manager

Calls the "File Management" menu.

Directories can be created and files managed in this menu (see [chapter 5.2.8.4, "File Manager"](#), on page 112).

SCPI command:

n.a.

5.2.8.3 Loading Instrument Settings

If "Recall" is selected under "Select Operation", the "File" menu provides options for loading complete instrument settings. Here it is possible to select whether the current or stored frequency and level settings are to be used.

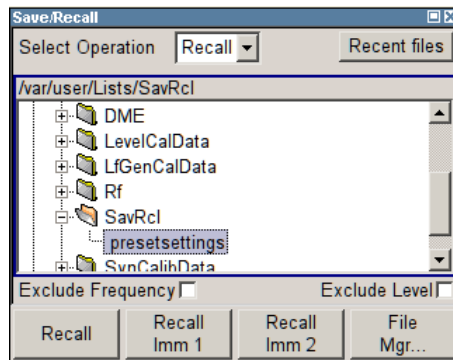

Recent data sets

Displays the files last used. The entire path is shown.

If the desired file is in the list, it can be selected.

SCPI command:

n.a.

Directory

Enter the directory in which the file with the instrument setting to be loaded is located.

The "Selected file" window lists all the files in this directory.

SCPI command:

[:MMEMory:CDIRectory](#) on page 383

File List

Selects the file with the desired instrument configuration.

SCPI command:

[:MMEMory:CATalog?](#) on page 382

Exclude Frequency

The current frequency is retained when a stored instrument setting is loaded.

SCPI command:

[\[:SOURce<hw>\]:FREQuency\[:CW|FIXed\]:RCL](#) on page 502

Exclude Level

The current level is retained when a stored instrument setting is loaded.

SCPI command:

[\[:SOURce<hw>\]:POWER\[:LEVel\]\[:IMMediate\]:RCL](#) on page 569

Recall

Load the selected configuration.

If an instrument setting in which a sweep was activated is stored, the sweep is started when the recall command is called.

If an instrument setting which accesses lists is stored, this list is also loaded.

If the list has been deleted in the meantime, an error message appears when the instrument setting is loaded. If the list has been overwritten in the meantime, the new entries will be used.

SCPI command:

:MMEMory:LOAD:STATe on page 386

*RCL on page 357

Recall Immediate x

Loads the selected configuration from one of the three intermediate memories.

If an instrument setting in which a sweep was activated is stored, the sweep is started when the recall command is called.

If an instrument setting which accesses lists is stored, this list is also loaded.

If the list has been deleted in the meantime, an error message appears when the instrument setting is loaded. If the list has been overwritten in the meantime, the new entries will be used.

A message appears if no instrument configuration is stored in this memory.

SCPI command:

*RCL on page 357

5.2.8.4 File Manager

The "File Manager" dialog provides all the functions required for file management. Directories can be created, and files copied, deleted and moved between the directories on the devices (CompactFlash™ Card and memory stick). A USB stick is automatically recognized when connected to the instrument and the USB directory 'usb/ISB_DISK (data dir)' indicated in the file manager.

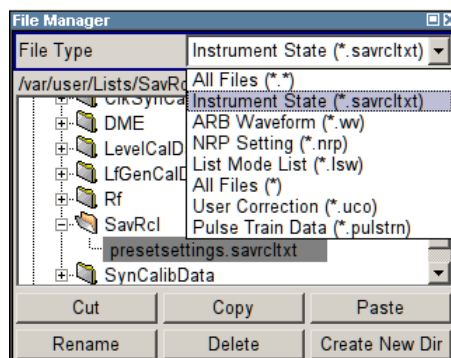

For more information, see [chapter 4.7.2, "File Manager"](#), on page 74.

File Type

Selects the file types to be indicated. If a file type with a specific file extension is selected only files with this extension are indicated in the selected directory.

SCPI command:

n.a.

Directory and File Name

Selects the directory in which the file to be deleted or copied is located. The window lists all files in this directory. The file to be deleted or copied can be highlighted. The path is indicated above the directory window.

SCPI command:

`:MMEMory:CDIRectory` on page 383

Cut

Cuts the selected file. It can be pasted into a different directory using the "Paste" button.

SCPI command:

`:MMEMory:DELeTe` on page 385

Copy

Copies the selected file. It can be pasted into a different or the same directory using the "Paste" button. When pasting the file into the same directory file name

`Copy of <file name>` is given automatically. When pasting the file into a different directory, the original file name is kept.

SCPI command:

`:MMEMory:COpy` on page 384

Paste

Pastes the file that has been copied or cut before.

SCPI command:

n.a.

Rename

Renames the selected file or directory. The new name can be entered in the "New File-name" dialog.

SCPI command:

`:MMEMory:MOve` on page 386

Delete

Deletes the selected file. Before the file is deleted, a message appears prompting the user to confirm deletion of the file.

SCPI command:

`:MMEMory:DELeTe` on page 385

Create New Directory

Creates a new directory. The name of the new directory can be entered in the "New Directory" dialog.

Note: When the subdirectory is entered, it is possible to enter an absolute path name (e.g. `/var/USER/MEAS`) or the path relative to the current directory (e.g. `../MEAS`).

The directory is created as a subdirectory in the selected level.

SCPI command:

`:MMEMory:MDIRectory` on page 386

5.3 RF Block

5.3.1 Overview of RF Signal

Settings for the RF output signal and analog modulation are made under "RF Signal". These settings can be accessed in the block diagram by way of the "RF" function block, or by means of the menu with the same name which is opened using the MENU key.

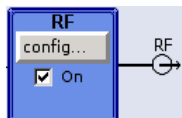

The function block is available for the basic unit (R&S SMA + frequency option R&S SMA-B10x) without additional equipment options.

5.3.1.1 RF Output

To activate and deactivate the RF output signal, use one of the following alternatives:

- by means of the RF ON/OFF key (the current entry focus is irrelevant)
- by changing the state of the "RF" functional block (see ["State RF"](#) on page 114)
- by enabling/disabling the RF in the "Configure" menu of the "RF" block (see ["RF Output State"](#) on page 115).

The current state of the RF output (activated and deactivated) is indicated in the block diagram by means of the different block color and the status of the "On" checkbox.

The disconnected connection to the output is additionally shown when the output is deactivated.



To query the impedance of the RF outputs, use the command `:OUTPut<hw>:IMPedance?` on page 389.

State RF

Activated/deactivates the RF output by changing the state of the "RF" functional block. Alternatively, the RF ON/OFF key can be used.

SCPI command:

`:OUTPut<hw>[:STATe]` on page 390

RF Output State

Activated/deactivates the RF output by enabling/disabling the RF in the "Configure" dialog of the "RF" block.

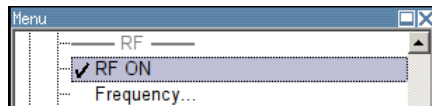

SCPI command:

`:OUTPut<hw>[:STATe]` on page 390

5.3.1.2 RF Signal Modes and Characteristics

The CW, Sweep and List modes are available for generating the RF signal.

- **CW**
The RF signal is generated with the set frequency and level. This is the default mode.
- **Sweep**
The RF signal is generated as a sweep with the set parameters.
It is not possible to activate frequency, level and LF sweep simultaneously.
- **List Mode**
The RF signal is generated on the basis of a list of predefined frequency and level values. The duration of the individual steps can be predefined.

Instruments connected downstream can be taken into consideration when setting the frequency and level by entering a frequency and/or level offset.

Automatic level control ("ALC") ensures maximum level accuracy.

User-specific lists which contain level correction values for any frequency range ("User Correction") can be created to, for example, compensate the cable attenuation in a test assembly setup.

The R&S Signal Generator generates the RF signal in unmodulated or analog form. The signal generator is equipped therefore with the following sources for analog modulations:

- an internal LF generator
- an internal pulse generator
- the external modulation inputs AM EXT/FM/PM EXT and PULSE EXT.

An external trigger signal for the analog modulations, the sweeps and the LIST mode can be provided at the INST TRIG input.

The input REF IN is used to input an external instrument reference, and the output REF OUT serves as the output of the reference frequency (internal or external).

5.3.2 RF Frequency

The value of the RF frequency is displayed in the header of the instrument's display ("Freq"). This field provides the direct input of the RF frequency. Alternatively, you can enter the RF frequency in the "Frequency/Phase" dialog.

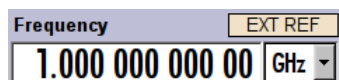

Be aware that the displayed RF frequency in the header, and the RF output frequency, entered in the "Frequency/Phase" dialog can be different, as explained in the following section.

5.3.2.1 RF Frequency vs. RF Output Frequency

The signal generator offers the possibility, to take additional frequency modifications of a downstream instrument into consideration, such as an offset set by a mixer, or a multiple of the frequency by a frequency multiplier. The R&S SMA indicates the resulting frequency, including offset and multiplication factor in the header of the screen. I.e. the indicated frequency corresponds to the frequency at the output of the downstream instrument. However, the frequency at the RF output of your signal generator always corresponds to the frequency set in the "Frequency/Phase" dialog.

In this dialog, you can also enter the values of the downstream instrument.

A set frequency offset is indicated by the "FREQ OFFSET" status message.

The correlation between the RF frequency, the RF output frequency and the frequency offset is as follows:

"Freq" (in header) = "RF output frequency" (Frequency in dialog) * "Multiplier" factor (Multiplier in dialog) + "Freq offset" (Offset in dialog)

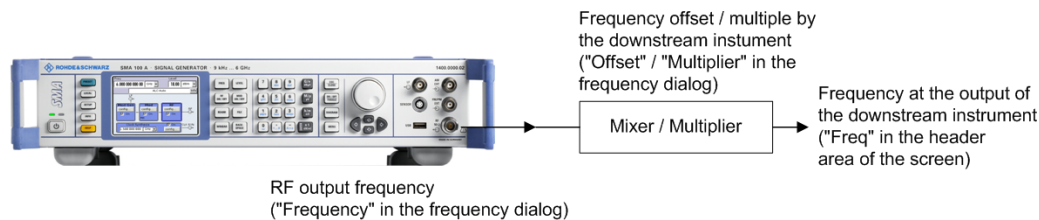

5.3.2.2 Setting the RF Frequency

To change the RF frequency, press the FREQ key and enter the desired frequency. Changes to the RF frequency have an immediate effect (without confirmation with the ENTER key) on the output signal.

RF Freq

Enters the RF frequency, considering the frequency offset.

Note: The SCPI command sets the level of the "Freq" display, i.e. an entered frequency offset and multiplier factor are taken into consideration in the frequency value.

SCPI command:

[:SOURce<hw>] :FREQuency [:CW | FIXed] on page 501

5.3.2.3 RF Frequency Dialog

In the combined "Frequency/Phase" dialog, you can enter the frequency, the frequency offset and multiplication factor of a downstream instrument, set the step width for the frequency entry using the rotary knob, and set the phase for the RF output signal.

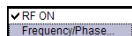

To open the "RF Frequency / Phase" dialog, select "RF" > "Configure" > "Frequency" or use the MENU key under "RF".

The "RF Frequency / Phase" dialog is divided into the several sections.

Frequency and offset of the RF output signal are set in the "Frequency Settings" section in the upper part of the dialog. In addition, the multiplier factor of an externally connected multiplier is specified.

The step width which is used when setting the frequency using the rotary knob (with "Variation Active On") is set in the "User Variation" section.

The phase of the output signal can be changed in the "Phase Settings" section. The "Phase Settings" menu is described in [chapter 5.3.3, "Phase"](#), on page 118.

Frequency Settings

The frequency, offset and multiplier factor are set in the top section of the menu.

Frequency - RF Signal

Sets the RF frequency of the RF output connector. The frequency entered and displayed here corresponds to the frequency at the RF output, i.e. any offset entry is not taken into consideration.

Note: The SCPI command `SOUR:FREQ` sets the frequency of the "FREQ" display, i.e. the frequency containing offset.

SCPI command:

n.a.

Offset - RF Signal

Sets the frequency offset relative to the RF frequency. The frequency offset of a downstream instrument (e.g. a mixer) is entered.

The entry does not change the value of the RF frequency at the RF output. It only changes the RF frequency displayed in the display header. The value of the RF frequency in the header corresponds to the frequency at the output of the downstream instrument.

SCPI command:

`[:SOURce<hw>] :FREQuency:OFFSet` on page 504

Multiplier - RF Signal

Sets the multiplication factor for the RF frequency.

In the frequency field of the status bar, the instrument adjusts its frequency display according to the set multiplication factor. This frequency value shows the frequency at the output of the downstream multiplier. The entry does not change the RF frequency at the RF output of the R&S SMA.

SCPI command:

`[:SOURce<hw>] :FREQuency:MUlTiplier` on page 504

Phase Continuous Frequency Settings

A phase continuous mode can be enabled in the "Phase Continuous Frequency Settings" section (see [chapter 5.3.3.2, "Phase Continuous Frequency Setting"](#), on page 119).

User Variation

If the frequency is set using the rotary knob, the step width is defined in the "User Variation" section.

Variation Active - RF Signal

Activates the user-defined step width used when varying the frequency value with the rotary knob.

"ON" The frequency value set with the rotary knob is varied using the user-defined step width which is entered under "Variation Step".

"OFF" The frequency value set with the rotary knob is varied in steps of one unit at the cursor position (standard operating mode).

SCPI command:

`[:SOURce<hw>] :FREQuency:STEP:MODE` on page 509

Variation Step - RF Signal

Sets the user-defined step width. This step width is used when entering the RF frequency using the rotary knob. Frequency variation with this step width must also be activated with "Variation Active".

SCPI command:

`[:SOURce<hw>] :FREQuency:STEP [:INCRement]` on page 508

5.3.3 Phase

The phase of the RF output signal can be changed in the "Phase Settings" section of the "RF Frequency/Phase" dialog.

5.3.3.1 Phase Settings

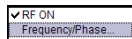

To open the "RF Frequency/Phase" menu, select "RF" > "Configure" > "Frequency / Phase" or use the MENU key under "RF".

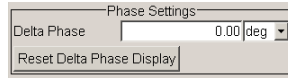

Delta Phase - RF Signal

Sets the phase of the RF signal. The current phase of the signal is used as the reference. This function allows, for example, the phase of the output signal to be synchronized with the phase of a signal from a second signal generator.

SCPI command:

[:SOURce<hw>] : PHASe on page 560

Reset Delta Phase Display - RF Signal

Resets delta phase value. The set phase is adopted as the new current phase, i.e. the delta phase value is reset to 0.

SCPI command:

[:SOURce<hw>] : PHASe : REFerence on page 561

5.3.3.2 Phase Continuous Frequency Setting

The phase continuous mode can be enabled in the "Phase Continuous Frequency Settings" section of the "Frequency" menu. In this mode, the output sinewave is phase continuous, i.e. there is no phase discontinuity or glitch when changing the frequency.

At the transition from one frequency to another an intermediate frequency (switching transient) occurs, which causes spurs (see figure below). The transient is due to changes of the synthesizer settings (e.g. dividers, filters, phase detectors).

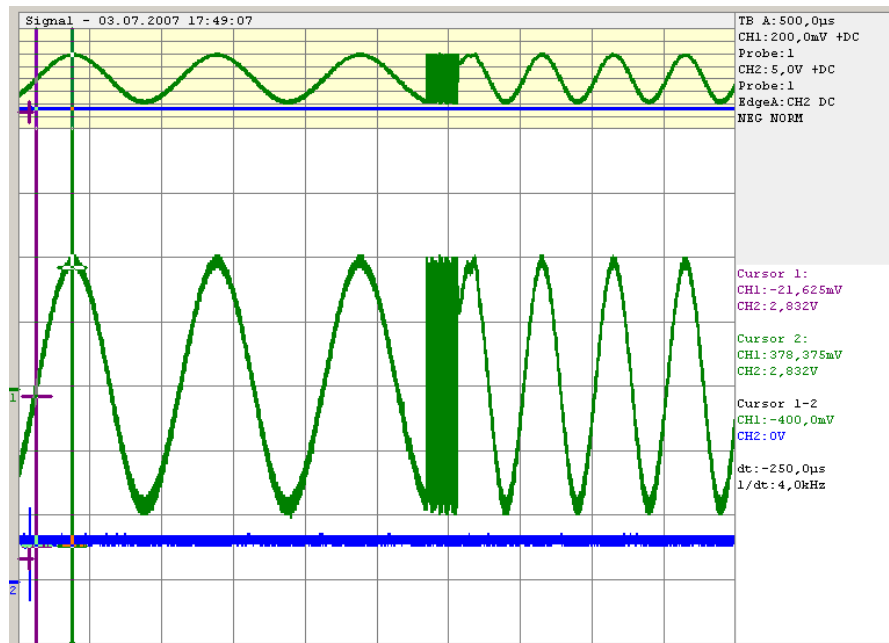

Fig. 5-1: Transition for a 1 kHz step at 1 GHz without phase continuous mode active. For the graphical display the signal is down converted into the kHz range.

The phase continuous mode freezes the settings of the synthesizer (e.g. dividers, filters, phase detectors) which could generate phase discontinuities when changed. The frequency change is effectively performed by changing the fine resolution synthesizer. This allows a phase continuous change from one frequency to another without any transients (see figure below).

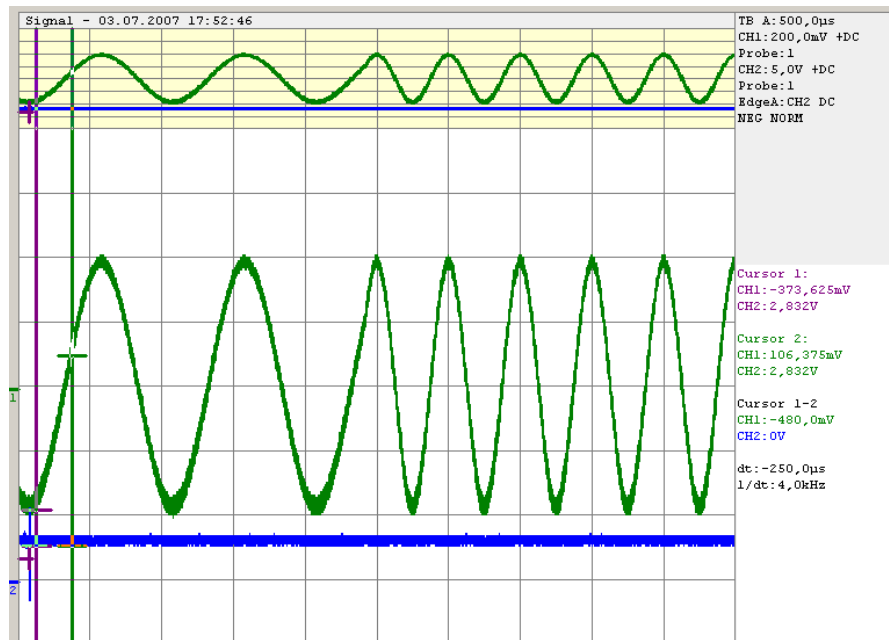

Fig. 5-2: Transition for a 1 kHz step at 1 GHz with phase continuous mode active. For the graphical display the signal is down converted into the kHz range.

The available frequency range for phase continuous settings is limited by the fine resolution synthesizer used and varies with the RF frequency setting at the point of activating the phase continuous mode.

Depending on the instrument equipment - with or without option R&S SMA-B22 - the fine resolution synthesizer used is a DDS (Direct Digital Synthesizer, with option R&S SMA-B22) or a Fractional N-Synthesizer (without option R&S SMA-B22). The DDS provides generally a wider frequency range for phase continuous settings. In addition, two modes (narrow and wide) allow a selection either in favor of higher signal quality or in favor of an especially wide frequency range.



When phase continuous frequency setting is active, data sheet values no longer apply. Activating frequency or phase modulation deactivates phase continuous settings and vice versa.

Setting a Phase Continuous Frequency Sweep

1. In the "RF Frequency Sweep" Menu, if the sweep is active, switch it off.
2. In the "RF Frequency" Menu under the "Phase Continuous Frequency Settings" dialog
 - a) If the "Phase Continuous Frequency Mode" is Active, switch it off
 - b) Set "Frequency Range" to "Narrow"
 - c) Select the RF frequency
 - d) Check displayed Frequency Range
 - e) If the "Frequency Range" corresponds to the selected frequency range, check the "Phase Continuous Active" box
 - f) If "Frequency Range" in Narrow Mode does not, select "Wide" for the Frequency Range and check the Phase Continuous Active box
3. In the "RF Frequency Sweep" dialog
 - a) Modify the "Start Freq" and "Stop Freq" or "Center Frequency" and "Span" as needed.
 - b) Set the RF frequency sweep State to "ON".

Optimum user settings for the phase continuous frequency sweep

In the "RF Frequency Sweep" dialog there are some settings that will improve the phase continuous sweep results for both "Narrow" and "Wide" mode choices.

1. "Step Lin": low step size
In order to get the best spur performance during frequency change, it is recommended to reduce the step size and (if necessary) increase the sweep speed by decreasing the Dwell Time. Effectively, the sweep will be performed in the same amount of time, but with smaller step sizes.
2. "Shape": Triangle sweep

The triangle sweep offers a uniform forward sweep and return to the beginning frequency. The saw tooth sweep produces a uniform forward sweep with an abrupt reset to the starting frequency. The abrupt reset can generate spurs.

Phase Continuous Frequency Settings Menu

The "Phase Continuous Frequency Settings" are available in the middle section of the "Frequency/Phase" dialog.

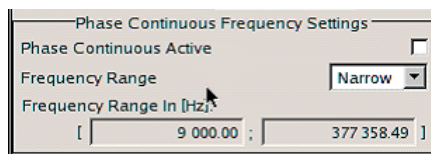

Phase Continuous Active

Activates/deactivates phase continuous frequency settings. For a given RF frequency setting, phase continuous frequency changes are possible in a limited frequency range.

An overview of the frequency ranges is provided in the table in "[Frequency Range - RF Signal](#)" on page 122.

For instrument without option B22:

The range is typically ± 0.5 MHz in the main synthesizer octave of 750 MHz to 1.5 GHz.

Note: If "Phase Continuous" is "Active" a setting of the "RF Frequency" outside the available "Frequency Range" causes an error. A settings conflict is displayed.

For instrument with option B22:

The frequency range is indicated in the table in section "[Frequency Range - RF Signal](#)" on page 122. The range indication is active even if phase continuous frequency setting is not yet activated. Thus, the desired range can be determined before activating the function. Two modes are available.

Note: If "Phase Continuous" is "Active" a setting of the "RF Frequency" outside the indicated "Frequency Range" is only possible for mode Wide. A settings conflict is displayed.

SCPI command:

`[:SOURce<hw>] :FREQuency:PHASe:CONTInuous:STATe` on page 506

Frequency Range - RF Signal

(instruments with R&S SMA-B22 option only)

Selects the mode for determining the frequency range for the phase continuous signal.

The frequency range depends on the selected mode.

RF frequency [MHZ]	Typ . range without R&S SMA-B22	Range with R&S SMA-B22 Narrow mode	Range with R&S SMA-B22 Wide mode
$f \leq 6.6$	125 kHz	625 kHz	2.5 MHz
$6.6 < f \leq 11.71875$	7.813 kHz	39.625 kHz	156.25 kHz
$11.71875 < f \leq 23.4375$	15.625 kHz	78.125 kHz	312.5 kHz
$23.4375 < f \leq 46.875$	31.25 kHz	156.25 kHz	625 kHz

RF frequency [MHZ]	Typ . range without R&S SMA-B22	Range with R&S SMA-B22 Narrow mode	Range with R&S SMA-B22 Wide mode
46.875 < f <= 93.75	62.5 kHz	312.5 kHz	1250 kHz
93.75 < f <= 187.5	125 kHz	625 kHz	2.5 MHz
187.5 < f <= 375	250 kHz	1250 kHz	5 MHz
375 < f <= 750	500 kHz	2.5 MHz	10 MHz
750 < f <= 1500	1 MHz	5 MHz	20 MHz
1500 < f <= 3000	2 MHz	10 MHz	40 MHz
3000 < f <= 6000	4 MHz	20 MHz	80 MHz

"Narrow"

The available frequency range is smaller than with setting wide. It is asymmetrical around the RF frequency set at the point of activating the phase continuous settings (see table above).

In the narrow mode, a DDS frequency of 15 MHz to 20 MHz is used as reference signal to the phase detector. This provides a tuning range of 5 MHz in the main synthesizer octave from 750 MHz to 1.5 GHz. When activating the phase continuous settings, the current setting of the DDS is anywhere between 15 and 20 MHz, e.g. 17 MHz. Thus, the distribution around the center frequency most likely is asymmetrical, e.g. - 2 MHz and + 3 MHz for the 17 MHz. Signal quality is high because the larger mixing products are filtered by the low-pass filter (IF max. 20 MHz).

The narrow mode is recommended whenever possible due to the better signal quality (spectral purity).

It is not possible to set frequencies outside the available frequency range.

"Wide"

The wide mode provides a larger frequency range. The frequency range is symmetrical around the RF frequency set at the point of activating the phase continuous settings (see table above).

Due to an additional divider by 8 in the PLL the signal quality is reduced in this mode. At some frequencies non -harmonics will be present.

Setting frequencies outside the available frequency range is possible, however, a settings conflict is indicated. The usable overrange depends on the currently set RF frequency, e.g. at 1 GHz it reaches from 850 MHz to 1030 MHz.

SCPI command:

`[:SOURce<hw>] :FREQuency:PHASe:CONTInuous:MODE` on page 505

Frequency Range in [Hz] - RF Signal

(instruments with R&S SMA-B22 option only)

Displays the frequency range for phase continuous settings. The available frequency range depends on the mode selection ("Narrow" or "Wide").

The range indication is active even if phase continuous frequency settings are not yet activated. Thus, the desired range can be determined before activating the function.

SCPI command:

`[:SOURce<hw>] :FREQuency:PHASe:CONTInuous:HIGH?` on page 504

`[:SOURce<hw>] :FREQuency:PHASe:CONTInuous:LOW?` on page 505

5.3.4 Reference Oscillator

In the internal reference mode the internal reference signal is available at the REF OUT connector. The frequency of the internal reference signal is permanently set to 10 MHz.

External tuning can be used for **EFC (Electronic Frequency Control)**, e.g. in phase noise measurement systems. The resulting frequency variation is in the range between $4E10\text{-}9/\text{Volt}$ to $30E10\text{-}9/\text{Volt}$ (see data sheet). It depends on the installed options and is typ. 20 Hz/Volt for an RF output frequency of 1 GHz with option R&S SMA-B22, FM/PhiM modulation with low phase noise. The maximum bandwidth for the EXT TUNE input is approx. 50 Hz. The maximum bandwidth of an external PLL (Phase Locked Loop) used in a phase noise measurement system has to be set smaller than the bandwidth of the EXT TUNE input. If a higher bandwidth is required, the use of external FM modulation (DC coupling) with low noise mode is recommended. FM-DC mode yields a fixed tuning sensitivity which is independent from the set RF output frequency and which is equal to the set FM deviation.

External impairment is possible in both "Adjustment State" states (**On** or **Off**).

In the external reference mode, an external signal with selectable frequency and defined level must be input at the REF IN connector. This signal is output at the REF OUT connector. The "EXT REF" status message appears in the display header.



The settings of the reference oscillator are not influenced by an instrument preset ("PRESET" key).

5.3.4.1 Reference Oscillator Dialog

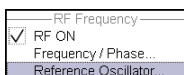

To open the "Reference Oscillator" dialog, select "RF > Configure > Reference Oscillator" or use the MENU key under "RF".

The menu is used to select the source, to enter the frequency of an external reference signal and to adjust the reference frequency.

The external mode corresponds to EFC mode (Electronic Frequency Control), see [Reference Oscillator](#) for more.

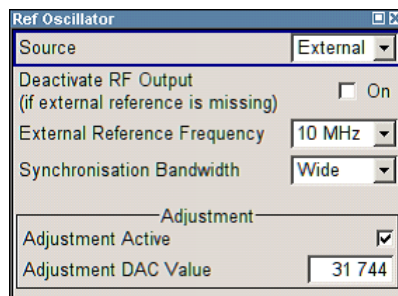

Source - Reference Oscillator

Selects the source of the reference frequency.

- "Internal" The internal reference signal of 10 MHz is used, comprising either the calibrated or a user-defined adjustment value.
- "External" An external reference signal is used. The frequency of the external reference signal must be selected under "External Reference Frequency".

SCPI command:

[\[:SOURce\]:ROSCillator:SOURce](#) on page 594

Deactivate RF Output - Reference Oscillator

Determines if the RF output is switched off in case of a missing external reference signal for selection external source.

If enabled, this setting ensures that no improper RF signal due to the missing external reference signal is output and used for measurements.

In addition to the error message "Ext Ref missing", the information "RF output deactivated" is indicated.

This setting is not influenced by a reset.

SCPI command:

[\[:SOURce\]:ROSCillator:EXTernal:RFOFf\[:STATe\]](#) on page 592

External Reference Frequency

Selects the frequency of the external reference signal. An external reference signal with a frequency of 5 MHz, 10 MHz or 13 MHz can be used.

SCPI command:

[\[:SOURce\]:ROSCillator:EXTernal:FREQuency](#) on page 592

Synchronization Bandwidth - RF Signal

(Source External only)

Selects the synchronization bandwidth for an external reference signal. The wideband setting is provided for using very good reference sources of high spectral purity.

- "Narrow"
- Instruments without R&S SMA-B22
Synchronization bandwidth is app. 20 Hz.
 - Instruments with R&S SMA-B22
Synchronization bandwidth is a few Hz. The internal 10-MHz OCXO is synchronized to the external signal. This setting is recommended if the phase noise of the external signal is worse than the phase noise of the internal OCXO.
- "Wide"
- Synchronization bandwidth is 750 Hz.
- Instruments without R&S SMA-B22
Recommended standard mode. Synchronization bandwidth is app. 750 Hz.
 - Instruments with R&S SMA-B22
This mode is recommended for good reference sources of high spectral purity. The internal 10-MHz OCXO is bypassed and the external signal synchronizes a 100-MHz reference oscillator directly. Synchronization bandwidth is app. 100 Hz.
- Note:** If the frequency of the external reference signal is outside the tuning range of the internal OCXO, spurs due to the difference of the internal and external reference frequency are generated in the reference PLL. An error message is indicated in this case.

SCPI command:

[\[:SOURce\]:ROSCillator:EXTernal:SBANdwidth](#) on page 593

Adjustment Active - Reference Oscillator

Selects adjustment mode.

- "OFF" The calibrated adjustment value of the internal reference frequency is used. This value is determined at one of the R&S service shops during calibration.
- "ON" A user-defined adjustment value is used. The value is entered under "Adjustment DAC Value".
This allows the frequency to be impaired freely, for example to simulate a frequency error.
The instrument is no longer in the calibrated state. However, the calibration value is not changed and the instrument resumes the calibrated state after switching the "Adjustment State" to Off.

SCPI command:

[\[:SOURce\]:ROSCillator\[:INTernal\]:ADJust\[:STATe\]](#) on page 594

Adjustment DAC Value

Enters a user-defined adjustment value for the internal reference frequency. This value is not used unless "Adjustment Active On" is selected.

SCPI command:

[\[:SOURce\]:ROSCillator\[:INTernal\]:ADJust:VALue](#) on page 594

5.3.5 RF Level

5.3.5.1 Overview of RF Level



Message "Level overrange/underrange"

If this message appears in the status line, the set level ("Level") is in the overrange (see data sheet).

The correct level setting and signal quality cannot be guaranteed if the set level is in the overrange/underrange.

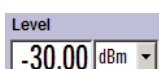

The value of the RF level is displayed in the level field in the header of the instrument's display and the easiest way to set the RF level is to set it directly in this field.

Be aware, that there is a difference between the RF level displayed in the header and the RF output level set in the "Level/EMF" dialog of the "RF" block.

RF level vs. RF output level

The level entered and displayed in the "Level" field takes the offset of any downstream attenuators/amplifiers into consideration by way of calculation. This means that with a level offset the level displayed in the header does not correspond to the level at the RF output, but rather to the level at the output of the downstream instrument.

This allows the desired level at the output of downstream instruments to be entered. The R&S Signal Generator changes the RF output level according to the set offset.

However, the level entered and displayed in the "Level" menu of the "RF" function block always corresponds to the RF output level. Any level offset is not taken into consideration.

The level offset is entered in the "Level" menu. Here it is also possible to set the level without taking the offset into consideration, and to make other settings, such as level offset, attenuator mode, power-on state.

The correlation is as follows:

"Level" (in header) = "RF output level" (Level in menu) + "Level offset" (Offset in menu)

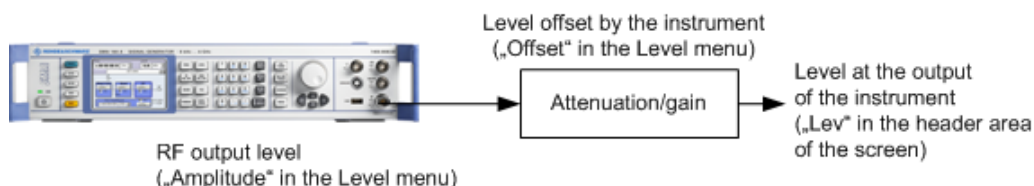

The RF output is protected against overloading by an external signal applied to the RF output (see ["Reverse Power Protection"](#) on page 131).

Setting the RF level

To change the RF level, press the LEVEL key and enter the desired level. Changes to the RF level have an immediate effect (without confirmation with the Enter key) on the output signal.

RF Level

Enters the RF level, considering the level offset (see ["RF level vs. RF output level"](#) on page 127).

dBm, dBuV, mV and uV can be used as the level units. The 4 unit keys are labeled with these units.

Note: The SCPI command sets the level of the "Level" display, i.e. an entered level offset is taken into consideration in the level value.

SCPI command:

`[:SOURce<hw>] :POWER [:LEVel] [:IMMediate] [:AMPLitude]` on page 568

5.3.5.2 RF Level Dialog



To open the "RF Level / EMF" dialog, select "RF" > "Configure" > "Level / Attenuator" or use the MENU key under "RF".

The combined "RF Level / EMF" dialog is divided into the several sections.

The top sections of this dialog provide access to the level settings.

The offset-free level, level offset and level limit are set in the top section of the menu. The attenuator mode is set in the "Attenuator Settings" section.

The step width which is used when setting the level using the rotary knob (with "Variation Active On") is set in the "User Variation" section.

The power-on behavior of the instrument and the level display in the display header are set in the "Power-On / EMF Settings" section (see [chapter 5.3.5.3, "Power-On/EMF Settings"](#), on page 132).

Level Settings

The offset-free level, attenuation mode, level offset and level limit are set in the top section of the menu.

Amplitude

Sets the RF level of the RF output connector.

The level entered and displayed here corresponds to the level at the RF output, i.e. any offset entry is not taken into consideration.

Note: The SCPI command `[:SOURce<hw>] :POWER [:LEVel] [:IMMediate] [:AMPLitude]` sets the level of the "Level" display, i.e. the level containing offset.

SCPI command:

`[:SOURce<hw>] :POWER :POWER` on page 572

Limit - RF Level

Sets an upper limit for the RF output power.

You can use it to protect your DUT from damage due to high input power. If you enter an RF level above this value, the instrument limits the output power to this specified value, and generates a warning message.

However, the level indication in the status bar is not affected.

Note: The value is not affected by an instrument preset (PRESET key), *RST and the "Save/Recall" function. It is influenced only by the [Factory Preset](#) and the factory value is equal to maximum level.

SCPI command:

`[:SOURce<hw>] :POWER :LIMit [:AMPLitude]` on page 570

Offset (Level)

Sets the level offset relative to the RF level.

The level offset of a downstream instrument (e.g. an attenuator or amplifier) is entered.

The entry does not change the value of the RF level at the RF output. It only changes the RF level displayed in the display header. The value of the RF level in the header corresponds to the level at the output of the downstream instrument.

SCPI command:

`[:SOURce<hw>] :POWER [:LEVel] [:IMMediate] :OFFSet` on page 569

Attenuator Settings

The R&S SMA can be configured to provide level settings without interruption. This applies to instruments with, as well as without step attenuator. The attenuator mode is set in the "Attenuator Settings" section of the "RF level / EMF" dialog.

Attenuator Mode

Sets the attenuator mode at the RF output.

"Auto"	Standard mode. The entire level range is available. The level settings are made in the area of the electronically switching attenuator as well as in the area of the relay-switched high power bypass (longer switchover time, wear).
"Normal"	The level settings are made only in the area of the electronically switching attenuator. The high level ranges are not available. This setting is wear-free, as the relays are not switched.
"High Power"	The level settings are made only in the area of the high-power bypass. Only the high level range is available. The relays are not switched.
"Fixed"	The level settings are made without switching the attenuator and the relays. When this operating mode is switched on, the attenuator and the relays are fixed in their current positions to provide level settings without interruption. The resulting variation range is defined and displayed under "Attenuator Fixed Range". Note: The function is effective when automatic level control is activated ("ALC State = On"). If the normal variation range is overranged or underranged, level errors increase considerably and the warning "Level under/overrange" appears in the info line. The spectral purity of the output signal decreases with high attenuation.

SCPI command:

`:OUTPut<hw>:AMODE` on page 389

Fixed Range (PEP) In

Displays the level range in which the level is set without interruption for the "Attenuator Mode fixed" setting.

SCPI command:

`:OUTPut<hw>:AFIXed:RANGe:UPPer?` on page 388

`:OUTPut<hw>:AFIXed:RANGe:LOWer?` on page 388

RF OFF Mode

Selects the attenuator mode, when the RF signal is switched off.

The setting of the RF OFF mode is not affected by an instrument preset (PRESET key), *RST and the "Save/Recall" function. This parameter is influenced only by the [Factory Preset](#).

"Unchanged"	Freezes the setting of the attenuator when RF is switched off. The attenuator is only activated when RF is switched on. This setting recommended if a constant VSWR (V oltage S tanding W ave R atio) is required. Furthermore, it provides fast and wear-free operation of the relay-switched high power bypass.
-------------	--

"Full Attenuation"

Sets attenuation to maximum when the RF signal is switched off. This setting is recommended for applications that require a high level of noise suppression.

SCPI command:

`[:SOURce<hw>] :POWer:ATTenuation:RFOff:MODE` on page 567

User Variation

If the level is set using the rotary knob, the step width is defined in the "User Variation" section.

Variation Active

Activates the user-defined step width used when varying the level value with the rotary knob.

"ON" The level value set with the rotary knob is varied using the user-defined step width which is entered under "Variation Step".

"OFF" The level value set with the rotary knob is varied in steps of one unit at the cursor position (standard operating mode).

SCPI command:

`[:SOURce<hw>] :POWer:STEP:MODE` on page 575

Variation Step

Sets the user-defined step width for entering the RF level using the rotary knob. Level variation with this step width must also be activated with "Variation Active".

SCPI command:

`[:SOURce<hw>] :POWer:STEP [:INCRement]` on page 575

Reverse Power Protection

The reverse power protection prevents against overload by an external signal applied to the RF output of the R&S Signal Generator.

The reverse power protection is tripped when the power of the external signal becomes too high. A relay opens and interrupts the internal connection to the RF output. This condition is indicated in the display header by the "OVERLOAD" status message.

Overload

If an "Overload" status message is indicated in the display header, reset the overload protection by pressing the RF ON/OFF key.

The RF input is activated when the overload protection is reset.

SCPI command:

`:OUTPut<hw>:PROTection:TRIPped?` on page 390

`:OUTPut<hw>:PROTection:CLEar` on page 390

`:OUTPut<hw> [:STATe]` on page 390

5.3.5.3 Power-On/EMF Settings

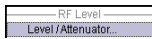

The power-on behavior of the R&S SMA and the level display in the display header are set in the "Power-On / EMF Settings" section of the "RF Level/EMF" dialog.

To open the "RF Level/EMF" dialog, select "RF > Configure > EMF" or use the MENU key under "RF".

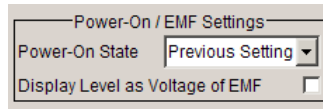

Power-On State - RF Signal

Selects the state which the RF output is to assume after the instrument is switched on.

"RF Off" The output is deactivated when the instrument is switched on.

"Previous Setting" When the instrument is switched on, the output assumes the same state as it had when the instrument was switched off.

SCPI command:

`:OUTPut<hw>[:STATe]:PON` on page 390

Display Level as Voltage of EMF - RF Level

Activates display of the signal level as voltage of the EMF (no-load voltage). If this setting is deactivated, the level is displayed as a voltage over a 50 Ohm load (preset state).

SCPI command:

n.a.

5.3.5.4 Automatic Level Control - ALC

Your signal generator is equipped with an automatic level control unit to obtain best RF level accuracy.

Automatic Level Control (ALC) is an adaptive control system to stabilize the RF output level. It continuously monitors the current level and adjusts it to keep a steady state over temperature and time.



ALC is active in almost all applications by default. However, some operating modes exclude ALC, as the control loop would detect incorrect values and result in level deviations. These are:

- Pulse modulation
- DME modulation

Also note that ALC may detect incorrect values in **multi-transmitter** test setups. If multiple generators are coupled, reverse power may affect the ALC readings. Based on incorrect values, ALC would have an impact on the signal to intermodulation ratio.

ALC States

The following description basically explains the ALC states and their principle of operation. In particular **ALC OFF (Sample & Hold)** gives an overview on the function in terms of the equipment of the generator.

The R&S SMA offers the ALC states:

- **AUTO**
automatically adjusts the output level to the operating conditions.
- **On**
enables ALC permanently, regardless of the currently selected mode.
- **Off**
deactivates ALC.
The instrument switches to **Sample & Hold (S&H)** state, which still allows to maintain a constant output level.

The following section explains the functionality of "Sample & Hold", to provide an overview and to indicate what is to be considered. "On" and "Auto" require no additional explanation. Furthermore, find the ALC state settings described in detail in [State - ALC](#).

ALC OFF (Sample & Hold)

In "S&H" mode, the signal generator switches for a short period of time into CW mode and activates ALC. ALC adjusts the level to the set value and the generator holds the value (freeze). Then, the generator switches ALC off again and back to the operating mode.

RF output behavior during Sample & Hold depends on the configuration of your instrument. Instruments equipped with...:

- an **electronic step attenuator**
The level is decreased by 30 dB.
- a **mechanical step attenuator**
- **no step attenuator**
The signal generator outputs the set level for 3 to 5 ms after level or frequency setting during a Sample & hold measurement.
Instruments equipped with one of the options R&S SMA-B103L or R&S SMA-B106L come without step attenuator.

The level control status is permanently displayed as a status message in the info line.

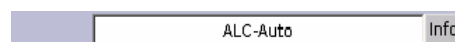

Automatic Level Control Settings

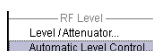

To open the "Automatic Level Control" dialog, select "RF" > "Configure" > "Automatic Level Control" or use the MENU key under "RF".

The combined dialog "ALC / UCOR" is divided into the several sections and provides access to the "Automatic Level Control" settings and to function "User Correction", see [chapter 5.3.5.6, "User Correction"](#), on page 138).

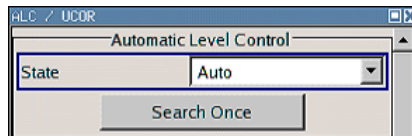

State - ALC

Activates/deactivates internal level control.

- | | |
|-----------------------|--|
| "Auto" | The instrument selects the most appropriate ALC mode automatically. ALC is on in most operating conditions. Default state. |
| "On" | Activates ALC, regardless of the operating conditions. If "Attenuator Mode Fixed" is selected in addition, the instrument adjusts the level of every level and frequency setting. |
| "Off (Sample & Hold)" | Deactivates internal level control. Sample & hold closes the level control loop at every frequency and level change for a short period of time. The level control voltage is sampled and then clamped. |

SCPI command:

[\[:SOURce<hw>\]:POWER:ALC\[:STATe\]](#) on page 567

Search Once - ALC

Forces the generator to execute level adjustment once, although the "Sample & Hold" mode is active.

SCPI command:

[\[:SOURce<hw>\]:POWER:ALC:SONCe](#) on page 567

5.3.5.5 NRP-Z Level Control

With the NRP-Z Level Control function, you can achieve a very stable and accurate RF power supplied to your DUT. With the aid of a downstream control circuit, a closed loop power control, you can detect frequency response characteristics of the used components, such as losses due to cables, modules or components like power amplifiers, and compensate these effects accordingly.

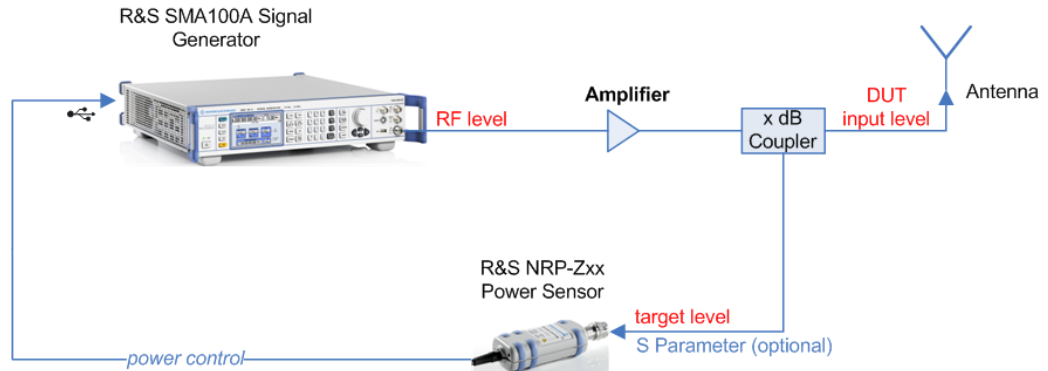
Example: How to set up a closed loop power control**Fig. 5-3: Example of a test setup with NRP-Z Level Control**

As shown in the example, the sensor measures a proportional power in defined time intervals, derived from a coupler. It considers optionally given S-parameters and sends the results back to the generator. The signal generator compares the measured level with the set value and adjusts its output level accordingly.

This allows you to control the external signal level continuously and reliably reach a constant input level at the DUT in real time.



"NRP-Z Level Control" automatically disables [NRP-Z Power Viewer](#) and [NRP-Z Power Analysis](#), and vice versa.

Please keep in mind that modulated signals may differ from CW signals regarding mean power and peak power. This affects the operation of "NRP-Z Level Control".

Beyond that, it is strongly recommended that you disable the "List" mode, since it also falsifies the power control loop.

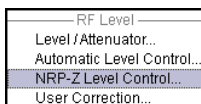
NRP-Z Level Control Settings

To open the "NRP-Z Level Control" dialog, select "RF > Configure > NRP-Z Level Control" or use the MENU key under "RF".

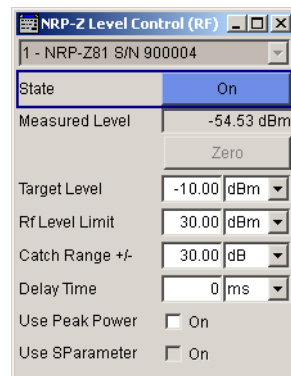
**Sensor**

Selects the R&S NRP-Z power sensor for power control.

Note: In remote control, the sensors are set up using the `SENSe` commands. The remote measurement is triggered by the `READ` query which also provides the measurement results.

The software version of the connected power sensor can be retrieved by means of the remote control command `:SENS:POW:TYPE?`.

Use the "Setup >" [chapter 5.2.3.6, "NRP-Z Info/Update"](#), on page 88 dialog to update the sensor software.

SCPI command:

`[:SOURce<hw>] :POWer:SPC:SElect` on page 574

State

Activates power control using the selected sensor.

The control loop periodically adjusts the generator output. After switching off, the running loop is completed.

SCPI command:

`[:SOURce<hw>] :POWer:SPC:STATe` on page 574

Measured Level

Indicates the current reading of the sensor.

Zero - Power Sensors

Activates the auto zero function.

Zeroing calibrates the external power sensor by adjusting its reading at zero signal power. For this purpose, the RF power source must be switched off or disconnected from the sensor (see tips below). R&S power sensors automatically detect the presence of any significant input power. This aborts zeroing and generates an error message. Zeroing can take a few seconds, depending on the sensor model; refer to the documentation of your external power sensor for more information.

Tips for zeroing

Zeroing should be performed:

- During warm-up after switching on or connecting the instrument
- After a substantial change of the ambient temperature
- After fastening the power sensor module to an RF connector at high temperature
- After several hours of operation
- When very low-power signals are to be measured, e.g. less than 10 dB above the lower measurement limit.
- Switch off the RF power source for zeroing; do not disconnect it from the power sensor. In this way you will maintain the thermal equilibrium, and zeroing will also compensate for the noise superimposed on the measured signal (e.g. from a broadband amplifier).

SCPI command:

`SENSe<ch> [:POWer] :ZERO` on page 438

Target Level

Specifies the nominal level expected at the input of the sensor. The signal generator adjusts the output power accordingly, in order to meet the target value at the sensor input, and thus the power required at the DUT.

SCPI command:

`[:SOURce<hw>] :POWer:SPC:TARGet` on page 574

Limit - RF Level

Sets an upper limit for the RF output power.

You can use it to protect your DUT from damage due to high input power. If you enter an RF level above this value, the instrument limits the output power to this specified value, and generates a warning message.

However, the level indication in the status bar is not affected.

Note: The value is not affected by an instrument preset (PRESET key), *RST and the "Save/Recall" function. It is influenced only by the [Factory Preset](#) and the factory value is equal to maximum level.

SCPI command:

`[:SOURce<hw>] :POWer:LIMit [:AMPLitude]` on page 570

Catch Range +/-

Sets the capture range of the control system.

Within the range:

Target Level +/- Catch Range

the power control locks and tries to achieve the target level. Readings outside the range are not considered.

SCPI command:

`[:SOURce<hw>] :POWer:SPC:CRANge` on page 573

Delay Time

Defines a waiting period between the level adjustment of the generator and the next measurement of the power sensor.

With this parameter, you can take into account any dead times in the controlled system.

SCPI command:

`[:SOURce<hw>] :POWer:SPC:DELay` on page 573

Use Peak Power

Activates control by means of the peak power values, provided the power sensor supports this function. Otherwise, the dialog does not show this parameter.

SCPI command:

`[:SOURce<hw>] :POWer:SPC:PEAK` on page 573

Use SParameter - Power Sensors

Activates the use of the S-Parameter correction data of the connected power sensor. For sensors with attenuator this checkbox is automatically checked.

Refer to the manual of the connected R&S NRP-Zxx power sensor for a description on how to use the SParameter table.

SCPI command:

[SENSe<ch>\[:POWER\]:CORRection:SPDevice:STATe](#) on page 400

5.3.5.6 User Correction

The "User Correction" function is used to create and activate lists in which level correction values predefined by the user are freely assigned to RF frequencies. Correction is performed by the user-defined table values being added to the output level for the respective RF frequency.

With frequencies which are not contained in the list, the level correction is determined by interpolation of the closest correction values.

The lists are created in the "List Editor". Each list is stored in its own file with the predefined file extension *.uc. The name of the User Correction file can be freely selected. The files are loaded from the "Lists..." file manager. Externally created tables with pairs of frequency and level values can be converted into User Correction files using the import function. The external files must have the file extension *.txt or *.csv. These file formats are provided e.g. by the Microsoft Excel program. The separators for table columns and for decimal floating-point numerals can be set. In addition, internally created User Correction data can be exported into ASCII files using the export function.

The amplitude can also be linearized automatically by means of an R&S NRP power sensor connected to one of the generator output signals. With the aid of the "Fill with Sensor" function, a table with correction values for external test assemblies can be automatically determined, e.g. for compensating the frequency response of cables. The User Correction list with the correction values acquired by the sensor is generated in the "Edit User Correction List" menu. The correction values can be acquired any time irrespective of the modulation settings of the generator.

If user correction is activated, the "UCOR" display (User Correction) is shown in the header together with the "Level" display. The RF output level is the sum of both values.

"Level" + "UCOR" = Output level

If activated, user correction is effective in all operating modes.

User Correction Menu

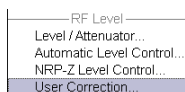

To open the "User Correction" menu, select "RF > Configure > User Correction" or use the MENU key under "RF".

The combined menu "ALC/UCOR" is divided into the several sections.

User Correction Settings

The "User Correction" settings are set in the most lower section of the combined dialog; this section is used to activate/deactivate user correction, and to create, select and activate the lists.

The upper section provides access to the automatic level control settings, see [chapter 5.3.5.4, "Automatic Level Control - ALC"](#), on page 132.

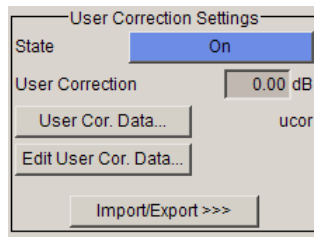

State - User Correction

Activates/deactivates user correction.

The "UCOR" status message appears in the frequency and level display.

SCPI command:

`[:SOURce<hw>] :CORRection [:STATe]` on page 469

User Correction Value - User Correction

Indicates the current value for level correction.

SCPI command:

`[:SOURce<hw>] :CORRection:VALue?` on page 470

User Cor. Data - User Correction

Calls the "File Select" menu for selecting and creating a list or the "File Manager".

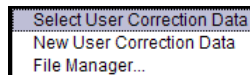

SCPI command:

`[:SOURce] :CORRection:CSET:DELeTe` on page 464

`[:SOURce<hw>] :CORRection:CSET [:SELeCt]` on page 469

Edit User Cor. Data - User Correction

Calls the editor for editing the selected user correction list.

A list consists of any number of frequency/level value pairs. The currently selected list is displayed.

Each list is saved as a separate file with extension `*.uco`. The file name and the directory to which the file is saved are user-selectable.

Note: Save list only after filling both columns (frequency and level), otherwise the entries are lost.

	Frequency/Hz	Power/dB
6	5 300 000.00	5.42
7	6 300 000.00	4.73
8	7 300 000.00	4.15
9	8 300 000.00	3.72
10	9 300 000.00	3.28

Goto Edit Save

"Frequency / Hz" Enters the frequency to which the level correction value applies.
Note: The "Fill..." function allows to automatically enter any number of frequencies with freely selectable range and increment. Using the "Fill With Sensor" function of the "Edit" sub menu requires only the entry of the frequency values. The level values are automatically acquired by the connected power sensor.

"Power/dB" Enters the level correction value to which the specified frequency applies. The values can be entered manually or automatically with the "Fill With Sensor" function (available in the "Edit" sub menu). The "Fill With Sensor" function requires option R&S SMA-K83.

"Goto" Selects row for editing.

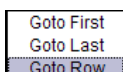

If Goto row is selected, a window opens for entering the requested row.

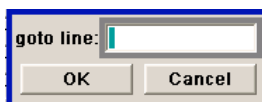

"Edit" Calls a selection of possible actions described below.

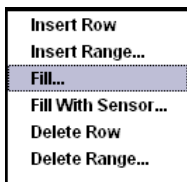

"Insert Row" Insert a new row before the marked row.

"Insert Range" Insert new rows before the marked row. The number of rows to be inserted can be defined in an entry window.

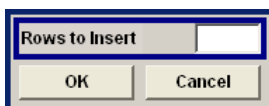

"Fill...." Opens a sub menu for defining a set of list values to be automatically entered in the ucor list (see ["Filling the Correction List automatically"](#) on page 142).

"Fill With Sensor" Calls the menu to activate the filling of the user correction list with level values acquired by the selected power sensor (see ["Filling the Correction List with Power Sensor Measurement Data"](#) on page 144).

"Delete Row" Deletes the marked row.

"Delete Range..." Allows to delete any number of rows starting with the marked row. The number of rows to be deleted can be defined in an entry window.

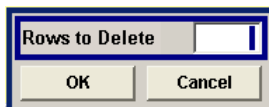

"Save" The list is saved under its current name.

SCPI command:

[\[:SOURce<hw>\]:CORRection:CSET\[:SELe\] on page 469](#)

[\[:SOURce<hw>\]:CORRection:CSET:DATA:FREQuency on page 463](#)

[\[:SOURce<hw>\]:CORRection:CSET:DATA:POWer on page 463](#)

Import/Export

User correction list can be imported from externally created files or exported into text or CSV-files. The import/export settings are available after clicking the "Import/Export" button.

Import/Export >>>

Expands the menu with the area for import and export of user correction files.

Externally edited Excel tables with any number of frequency/level value pairs can be imported as text or CSV-files and used for user correction.

Conversely, you can also export internally created user correction lists as text or CSV-files.

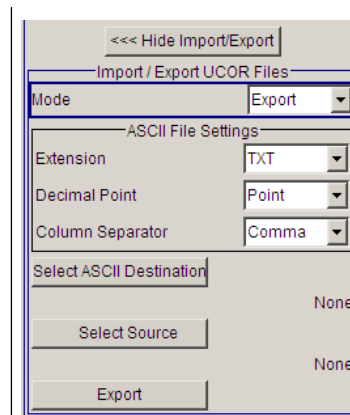
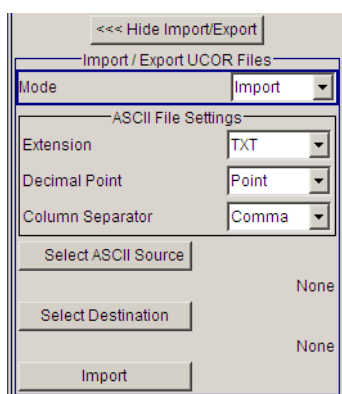

Mode - User Correction

Selects if user correction lists should be imported or exported. The settings offered depend on the selected mode.

SCPI command:

[\[:SOURce<hw>\]:CORRection:DEXChange:MODE on page 468](#)

Extension - User Correction

Selects the file extension of the ASCII file to be imported or exported. Selection "TXT" (text file) or "CSV" (Excel file) is available.

SCPI command:

[\[:SOURce<hw>\]:CORRection:DEXChange:AFILe:EXTension on page 465](#)

Decimal Point - User Correction

Selects the decimal separator used in the ASCII data between '.' (decimal point) and ',' (comma) with floating-point numerals.

SCPI command:

`[:SOURce<hw>] :CORRection:DEXChange:AFILe:SEParator:DECimal`
on page 467

Column Separator- User Correction

Selects the separator between the frequency and level column of the ASCII table the user correction list is exported to or imported from.

SCPI command:

`[:SOURce<hw>] :CORRection:DEXChange:AFILe:SEParator:COLumn`
on page 466

Select ASCII Source / Destination - User Correction

Calls the "File Manager" for selecting the ASCII file to be imported into a user correction list (source) or the ASCII file the user correction list is exported (destination) in.

SCPI command:

`[:SOURce<hw>] :CORRection:DEXChange:AFILe:SElect` on page 466

Destination / Source - User Correction

Calls the "File Manager" for selecting the user correction list to be exported (source) into an ASCII file or the destination for the ASCII file to be imported (destination) in.

SCPI command:

`[:SOURce<hw>] :CORRection:DEXChange:SElect` on page 468

Import / Export - User Correction

Starts the export or import of the selected file.

When import is selected, the ASCII file is imported as user correction list.

When export is selected, the user correction list is exported into the selected ASCII file.

SCPI command:

`[:SOURce<hw>] :CORRection:DEXChange:EXECute` on page 467

Filling the Correction List automatically

The "Fill Table" menu enables you to automatically set the level correction values.

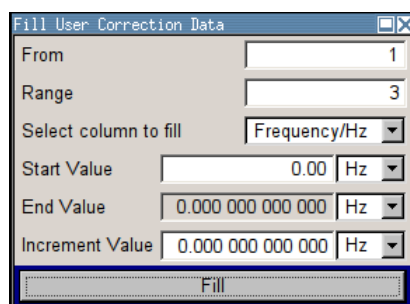

The start line and the number of rows to be filled are defined under "From" and "Range."

The column to be filled is selected under "Select column to fill". Depending on the selection here, the default for start, end, and increment value are set. As the settings are interdependent, a change of one parameter may result in the automatic change of one or more of the other parameters. The filling of the column with the selected value settings is started with button "Fill".



The correction list entries are only computed when the "Fill" button is pressed.

From

Sets the start value of the index range.

SCPI command:

n.a.

Range

Sets the range for filling the table.

SCPI command:

n.a.

Select column to fill

Selects either the frequency or the level column to be filled with the value defined below.

SCPI command:

n.a.

Start value

Sets the start value for the frequency or the level entries.

SCPI command:

n.a.

End value

Displays the end value for the frequency or the level entries.

SCPI command:

n.a.

Increment value

Sets the increment for the frequency or the level entries.

SCPI command:

n.a.

Fill

Fills the selected column in the set range with values, starting with the start value and using the set increment.

SCPI command:

n.a.

Filling the Correction List with Power Sensor Measurement Data

The level correction values for the user correction list can be acquired by means of R&S NRP power sensors. The R&S NRP sensors are connected to either the SENSOR connector or to one of the USB interfaces. Configuration of the connection is performed in the "Power Sensor" menu (see [chapter 5.3.6.2, "NRP-Z Power Viewer"](#), on page 145). The filling of the ucor list with measurement data is performed in the ucor list editor (see ["Edit User Cor. Data - User Correction"](#) on page 139).

In the editor, the frequencies for which the correction values are to be acquired are entered in the frequency column (either manually or by means of the "Fill..." menu).



Do not save the list at this point, because the frequency entries are lost as long as there are no entries for the level column also. In the following these entries are automatically acquired by the connected power sensor.

All level correction values for the given frequency values are measured using the Power Sensor and automatically filled in the selected list after the "Execute" button is pressed. The list is automatically stored and recalled again after filling.

Fill User Correction Data with Sensor Settings

The "Fill with Sensor" button of the "Edit User Correction Data" menu opens the associated menu.

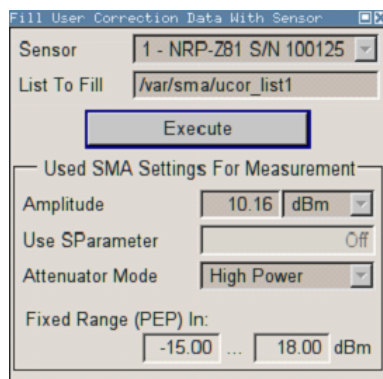

The menu indicates the relevant generator settings.

Fill User Correction Data with Sensor

All settings are read-only, except the "Sensor". In case more than one sensor is connected to the instrument, the sensor can be selected in the "Sensor" field of menu.

The "Execute" button is only enabled if a sensor is detected and the user correction list contains at least one frequency value.

SCPI command:

```
[ :SOURce<hw> ] :CORRection:CSET:DATA [ :SENSor<ch> ] [ :POWer ] :SONCe
```

on page 464

5.3.6 RF Measurement

5.3.6.1 Power Sensors

The R&S signal generator supports R&S NRP-Z power sensors to measure the power of the output signal in the RF path or any freely selectable source. The generator performs up to four power measurements, with the sensors either directly connected, or via the R&S NRP-Z5 USB Sensor Hub.



The R&S NRP-Z5 USB Sensor Hub (high-speed USB 2.0) can host up to 4 R&S NRP-Z sensors and provides simultaneous internal and external triggering of all connected sensors. You can directly connect the R&S NRP-Z Sensors to the standard NRP sensor connectors of the hub. The hub is connected to the R&S instrument either with the R&S NRP-Z2 extension cable, or via USB using with the adapter cable R&S NRP-Z4. See also the R&S website <http://www.rohde-schwarz.com> in section "Power Meters & Voltmeters > R&S NRP-Z Sensors" for information on the sensor hub and the available accessories.

To connect an R&S NRP-Z sensor directly, the R&S SMA provides the SENSOR connector. A sensor connected there is always assigned as Sensor 1. Alternatively, you can connect a sensor at a USB interface, using one of the USB adapters R&S NRP-Z3 or R&S NRP-Z4.

The instrument automatically detects a connected R&S NRP-Z power sensor and indicates it in the [NRP-Z Power Viewer](#) dialog. In addition, you find device specific information on the connected sensor in [chapter 5.2.3.6, "NRP-Z Info/Update"](#), on page 88. For information on the scope of your power sensor refer to the manual of your R&S NRP-Zxx power sensor.

For a more detailed analysis of the power of the RF signal, use the [NRP-Z Power Analysis](#) function. It enables you, e.g. to perform sweep measurements on the DUT, or analyse pulse data with the aid of a R&S NRP-Z81 power sensor.

5.3.6.2 NRP-Z Power Viewer

A sensor continuously measures the average signal power of the selected source. The signal generator shows the result in either the "NRP-Z Power Viewer" dialog, or directly in the block diagram. You can activate the permanent display in the block diagram in the "NRP-Z Power Viewer" dialog. This dialog provides access to all parameters concerning sensor settings, like average or peak display, reference source, filter and level offset, see [NRP-Z Power Viewer Settings](#).

The signal generator also supports the use of R&S NRP-Z power sensors for the acquisition of level correction data. The acquired level correction data is used to create and activate lists in which level correction values predefined by the user are freely assigned to RF frequencies. Correction is performed by the user-defined table values being added to the output level for the respective RF frequency (see [chapter 5.3.5.6, "User Correction"](#), on page 138).

In addition, it enables sweep measurements on DUTs (see [chapter 5.3.6.3, "NRP-Z Power Analysis"](#), on page 151). Pulse data analysis is possible with power sensor R&S NRP-Z81.

NRP-Z Power Viewer Settings

RF Measurement
NRP-Z Power Viewer

To open the "NRP-Z Power Viewer" menu, select "RF" > "Configure" > "NRP-Z Power Viewer" or use the MENU key under "RF".

The dialog shows the settings and measurement values of the sensor selected in the field next to the connector symbol. For indicating the parameters of another sensor, switch to the respective sensor in the selection list.

The instrument detects connected sensors automatically and lists all in the selection field.

"Sensor 1" is firmly assigned to the sensor on the circled SENSOR socket. If no sensor is connected to this socket, channel 1 remains not assigned. Sensors 2...4 are assigned to the sensors at the USB connectors, according to their sequence of connection.



When you connect your power sensor(s) via the R&S NRP-Z5 USB sensor hub, each channel of the hub is firmly assigned to the associated sensor channel in the generator.

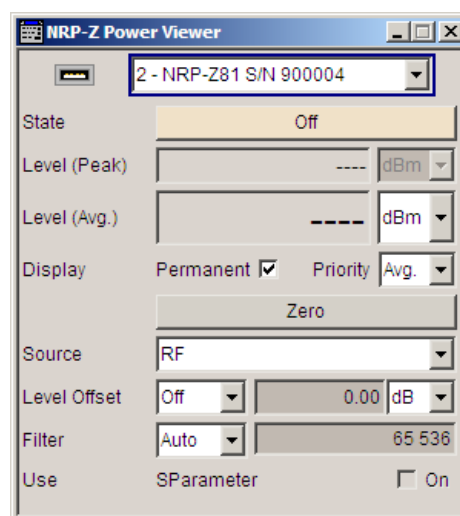
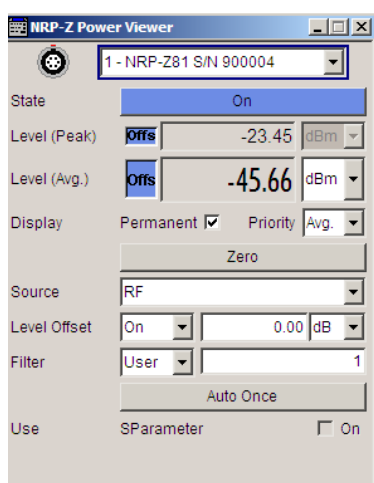

Sensor - Power Viewer

Selects the R&S NRP-Z power sensor for indication.

In remote control, the sensors are set up using the `SENSe` commands. The remote measurement is triggered by the `READ` query which also provides the measurement results.

The sensor is selected by suffix 1, 2, 3 or 4 in key word `SENSe` or `READ` of the command header.

Suffix 1 denotes the sensor connected to SENSOR, suffix 2 the one at the first USB interface, and suffix 3 and 4 are assigned to the sensors at the following USB interfaces. The suffix is identical to the index which is assigned automatically to each sensor upon connection.

In order to detect all connected sensors the state of all four connectors (i.e. SENSor1/ SENSor2/SENSor3/SENSor4) must be checked.

Note: The software version of the connected power sensor can be retrieved by means of the remote control command `:SENS:POW:TYPE?`.

Use the "Setup >" [chapter 5.2.3.6, "NRP-Z Info/Update"](#), on page 88 dialog to update the sensor software.

SCPI command:

`SENSe<ch>[:POWer]:STATus[:DEVIce]?` on page 406

Type - Power Sensors

Indicates the type and the serial number of the connected R&S NRP-Z power sensor. The sensor type is automatically detected.

SCPI command:

`SENSe<ch>[:POWer]:TYPE?` on page 437

`SENSe<ch>[:POWer]:SNUMber?` on page 405

State - Power Sensors

Activates/deactivates level measurement by the power sensor.

The local state is set with the `INIT` command. Switching the local state off enhances the measurement performance.

In remote control, the sensors are set up using the `SENSe` commands. The remote measurement is triggered by the `READ` query which also provides the measurement results. The state is not influenced by these commands, measurements results can be retrieved with local State on or off.

The sensor is selected by suffix 1, 2, 3 or 4 in key word `SENSe` or `READ` of the command header.

Suffix 1 denotes the sensor connected to `SENSOR`, suffix 2 the one at the first USB interface, and suffix 3 and 4 are assigned to the sensors at the following USB interfaces. The suffix is identical to the index which is assigned automatically to each sensor upon connection.

In order to detect all connected sensors the state of all four connectors (i.e. SENSor1/ SENSor2/SENSor3/SENSor4) must be checked.

To query the availability of a sensor at a given connector, use the command `SENSe<ch>[:POWer]:STATus[:DEVIce]?` on page 406.

SCPI command:

`:INITiate<ch>[:POWer]:CONTinuous` on page 397

Level (Peak) - Power Sensors

With certain power sensors only, e.g. R&S NRP-Z81.

Indicates the measured peak level value with the selected unit.

SCPI command:

`:READ<ch>[:POWer]?` on page 397

Level (Avg.) - Power Sensors

Indicates the measured level value with the selected unit.

SCPI command:

[:READ<ch>\[:POWER\]?](#) on page 397

Unit - Power Sensors

Selects the unit used for result display.

The power sensor provides the measured value in Watt.

In which unit the measured value is indicated is selected here and might be Watt, dBm or dBuV.

SCPI command:

[SENSe<ch>:UNIT\[:POWER\]](#) on page 438

Permanent Display State - Power Sensors

Activates the permanent indication of the power measurement result in the upper right corner of the block diagram. The instrument shows the type of sensor, the corresponding connector, the measurement source and - if set - the offset.

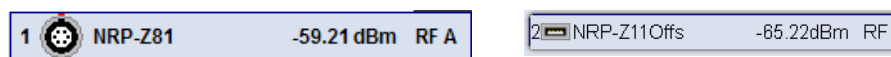

It is possible to switch the permanent display active for several sensors. In this case, the instrument indicates the values of the sensor with the lowest port number in the display.

SCPI command:

[SENSe<ch>\[:POWER\]:DISPlay:PERManent:STATe](#) on page 401

Display Priority - Power Sensors

Selects whether the average or the peak power measurement result is indicated when permanent display is active.

SCPI command:

[SENSe<ch>\[:POWER\]:DISPlay:PERManent:PRIority](#) on page 401

Zero - Power Sensors

Activates the auto zero function.

Zeroing calibrates the external power sensor by adjusting its reading at zero signal power. For this purpose, the RF power source must be switched off or disconnected from the sensor (see tips below). R&S power sensors automatically detect the presence of any significant input power. This aborts zeroing and generates an error message. Zeroing can take a few seconds, depending on the sensor model; refer to the documentation of your external power sensor for more information.

Tips for zeroing

Zeroing should be performed:

- During warm-up after switching on or connecting the instrument
- After a substantial change of the ambient temperature
- After fastening the power sensor module to an RF connector at high temperature
- After several hours of operation

- When very low-power signals are to be measured, e.g. less than 10 dB above the lower measurement limit.
- Switch off the RF power source for zeroing; do not disconnect it from the power sensor. In this way you will maintain the thermal equilibrium, and zeroing will also compensate for the noise superimposed on the measured signal (e.g. from a broadband amplifier).

SCPI command:

[SENSe<ch>\[:POWER\]:ZERO](#) on page 438

Source - Power Sensors

Selects the source for measurement.

"RF"	Measurement source is the RF signal of the generator. The RF frequency is used as the measurement frequency of the sensor and the corresponding correction factor is used. In this mode the RF frequency of the generator is send to the sensor automatically if changed.
"User"	Measurements source is any freely selectable source. The frequency is entered manually under frequency (e.g. for measurement of amplifier gain with 2 sensors).

SCPI command:

[SENSe<ch>\[:POWER\]:SOURCE](#) on page 405

Frequency - Power Sensors

Source User only

Enters the frequency for measurement source "User".

SCPI command:

[SENSe<ch>\[:POWER\]:FREQUENCY](#) on page 404

Level Offset - Power Sensors

Activates and defines a level offset which is added to the measured value. This allows e.g. an attenuator in the signal path to be taken into account. The offset is always entered in dB, irrespective of the selected unit for result display.

SCPI command:

[SENSe<ch>\[:POWER\]:OFFSET:STATE](#) on page 405

[SENSe<ch>\[:POWER\]:OFFSET](#) on page 404

Auto Once

Searches for the optimum filter length for the current measurement conditions and indicates value in the "Filter Length" field above.

SCPI command:

[SENSe<ch>\[:POWER\]:FILTER:SONCE](#) on page 403

Filter Length - Power Sensors

Selects the filter length used for measurement. The filter length is the multiplier for the measurement time and thus directly influences it.

The averaging filter is used to reduce fluctuations in the measured result to the extent desired. Such fluctuations can be caused by inherent noise of the measuring instrument, modulation of the measurement signal or beats from the superposition of adjacent carriers. A more stable display has to be traded off against longer measurements. The measurement result is obtained from a two-stage averaging process.

Note: Longer measurements does not mean that it takes longer to display a new result, but rather that it takes longer for the result to settle when the power changes.

Measurements are continuously repeated in a predefined time window. The measurement result is obtained by averaging the measured values for the last 2N time windows. The number N is the filter length, the factor of 2 arises because the output signals from the microwave detector to suppress low-frequency noise are chopped at the same rate as the time windows, which means that an independent measured value can only be obtained from two consecutive values. As the filter length is the multiplier for the time window it directly influences the measurement time.

The filter length can be selected automatically or can be manually set to a fixed value. As a preliminary, you should always check if the auto mode is giving satisfactory results because you will always have to adjust an optimal, manual filter-length setting if the power is not constant.

Selection "Fixed Noise" is offered for reaching defined measurement accuracy.

"Auto" The filter length is automatically selected and adapted to the currently measured value. With very high signals the filter length and therefore the measurement time can be short. With very low signal levels the filter length and therefore the measurement time is increased in order to reduce noise. The used filter length is indicated in the field to the right.

"User" The filter length is set manually. The filter length is entered in the entry window to the right. As the filter length works as a multiplier for the time window, this results in a constant measurement time. Values 1 and 2^n are settable.

Note: The time window varies depending on the used sensor. For most sensors it is fixed to 20 ms. For the R&S NRP-Z81 sensor it is 10 us. Therefore, the user filter length for the R&S NRP-Z81 has be about 1000 times larger than the filter length for other sensors in order to achieve the same filtering result.

The "Auto Once" button can be used to search for the optimum filter length for the current measurement conditions. The found filter length is indicated in the field to the right.

"Fixed Noise" The averaging factor is selected so that the sensor's intrinsic noise (2 standard deviations) does not exceed the specified noise content. The desired noise content is entered in the entry field to the right. To avoid very long settling times when the power is low, the averaging factor can be limited with the "Timeout" parameter.

SCPI command:

[SENSe<ch>\[:POWER\]:FILTer:TYPE](#) on page 403

[SENSe<ch>\[:POWER\]:FILTer:LENGth:AUTO?](#) on page 401

[SENSe<ch>\[:POWER\]:FILTer:LENGth\[:USER\]](#) on page 402

[SENSe<ch>\[:POWER\]:FILTer:NSRatio](#) on page 402

[SENSe<ch>\[:POWER\]:FILTer:NSRatio:MTIME](#) on page 402

Use SParameter - Power Sensors ← Filter Length - Power Sensors

Activates the use of the S-Parameter correction data of the connected power sensor. For sensors with attenuator this checkbox is automatically checked.

Refer to the manual of the connected R&S NRP-Zxx power sensor for a description on how to use the SParameter table.

SCPI command:

`SENSe<ch>[:POWER]:CORRection:SPDevice:STATe` on page 400

5.3.6.3 NRP-Z Power Analysis

The signal generator in combination with a connected R&S NRP probe allows sweep measurements on DUTs.

To open the "NRP-Z Analysis" dialog, select "RF > NRP-Z Power Analysis" or use the menu key under "RF".

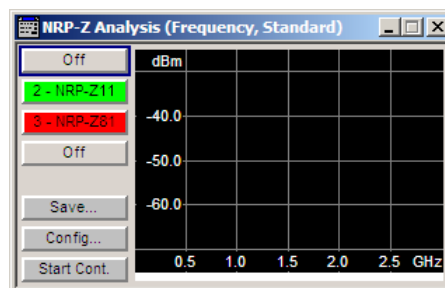

The measurement data of the sensors is displayed in traces in a measurement diagram. Four traces are available. The traces are automatically or manually assigned to the sensors. In addition to the data traces, a reference trace can be stored and recalled and/or the trace indication can be frozen temporarily (hold trace), thus enabling comparison of traces. Readout and comparison of particular values of the traces is possible by means of four markers.

Three measurement modes are offered:

- power versus frequency (frequency response)
- power versus power (power sweep, AM/AM)
These two modes are generator driven, i.e., the generator provides the measurement signal.
- power versus time (power measurement in the time domain R&S NRP trace mode).
This mode is signal driven, i.e. besides the generator signal also external signals can be analyzed. Time mode requires an additional trigger event, for which level, hysteresis and dropout time are freely selectable. The generator also features pulse data analysis in this mode, provided that R&S power sensor NRP-Z81 is connected.

The timing can be used for normal and fast measurements in all modes.

By the use of a separate frequency than the set generator frequency, measurement results retrieved at a different frequency can be displayed in the diagram (e.g. as provided at the output of the DUT).

Special functions of some hardkeys

The instrument provides hardkeys with special functions for convenient operation, when the "NRP-Z Power Analysis" dialogs are active.



The REARR key toggles between different views of the diagram, selectable in the "REARR list NRP-Z Analysis dialog", see ["REARR list - Power Analysis"](#) on page 166:

- standard, diagram and buttons are displayed,
- full display, diagram with marker list but no buttons are displayed,
- full display, diagram with pulse data list but no buttons are displayed, and
- full display only diagram is displayed.



The MENU and SETUP keys directly open a special power analysis menu. Either the complete menu tree or the setup menu tree is available in addition to the power analysis menu.

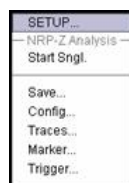

The instrument also provides this context-sensitive menu by pressing the right mouse button in the measurement diagram.



The ON /OFF key toggles between measurement start and stop.



The BACKSPACE key resets the scaling of the y-axis to suitable values after the use of auto scaling in the expanding mode. In this mode, the y scale might get too expanded due to temporary high power values. The reset function resets the diagram again, to also indicate smaller power values.

If "Auto Scale" is turned off, press the BACKSPACE button to switch to Auto Scale expanding mode, and to reset "Auto Scale".

Example Test Setup

As a power meter has no built-in selection, it is measuring all signal components from nearly DC to 40 GHz and higher. Therefore, the DUT's signal must be rather pure or subjected to external filtering (harmonics, spurious) before measured.

The test setup for the power analysis in the **power versus frequency or power versus power** is as follows:

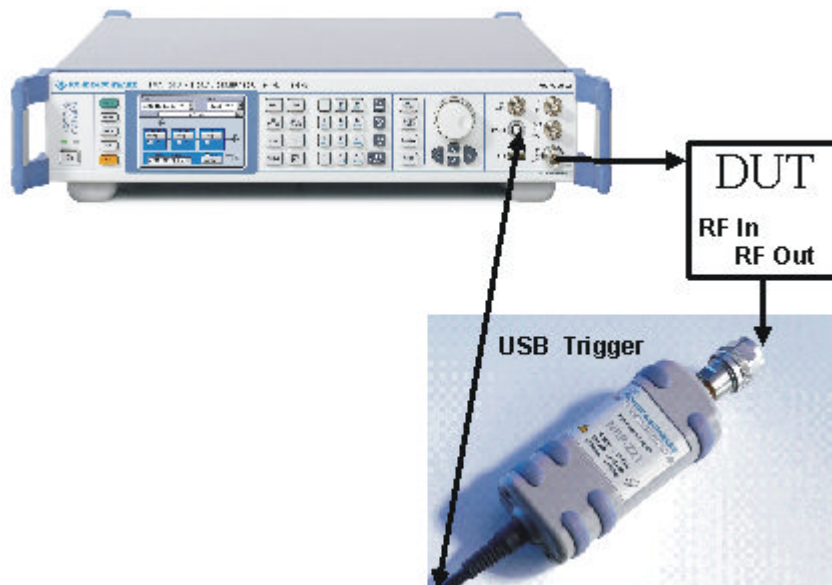

1. Connect the DUT (e.g. bandpass) to the RF output of the instrument and the RF input of the R&S NRP-Zxx sensor (e.g. R&S NRP-Z21).
2. Connect the USB output of the R&S NRP-Zxx to the SENSOR connector of the instrument.
3. Open the "NRP-Z Analysis" diagram in the "RF" block of the generator
4. Setup the measurement and scale diagram in the "Configure..." dialog (e.g. fast measurement, 200 measurement points, range, x-axis and y-axis scale).
5. Trigger measurement by pressing the "Start" button in the "NRP-Z Power Analysis" diagram.
6. If required, perform the further settings:
 - a) Set markers by means of the rotary knob. To access the markers activate the "NRP-Z Analysis Frequency / Marker" diagram view with the REARR key. The markers are moved by means of the cursor and the roll key to the desired trace position.
Note: The "NRP-Z Analysis Frequency / Marker" view is activated in the "REARR list NRP-Z Analysis" dialog (see ["REARR list - Power Analysis"](#) on page 166). Press the REARR key repeatedly until you have this view.
 - b) Store a hardcopy of the measurement results ["Configure Diagram"](#) on page 165 ("Save..." submenu).
 - c) Apply user correction. "Ucor" is also available for NRP-Z measurements (see [chapter 5.3.5.6, "User Correction"](#), on page 138).

The diagrams below show the result of the above settings, an RF frequency range of 1-6 GHz and the level range of -65 dB to 5 dB.

The graphs show the different diagram views.

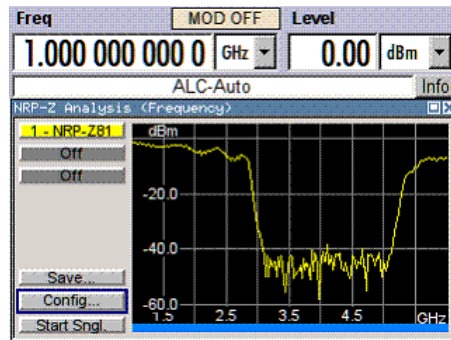

Fig. 5-4: Standard view, diagram and buttons are displayed

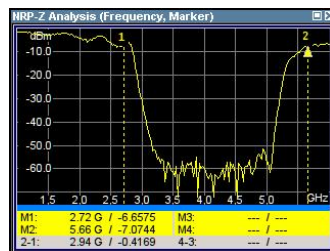

Fig. 5-5: Full screen "Marker View", diagram and marker list are displayed

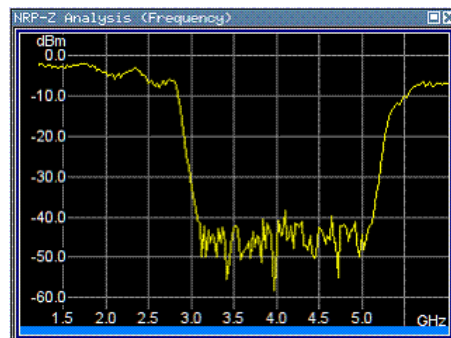
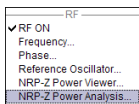

Fig. 5-6: Fullscreen view, only the diagram is displayed

Measurement Diagram



To open the "NRP-Z Power Analysis" diagram, select "RF > Configure > NRP-Z Power Analysis" or use the MENU key under "RF".

The dialog comprises the measurement diagram with start button and provides access to the dialogs for setting up the measurement and sensor parameters, for configuring the diagram and trace indication, and for storing hardcopies of the measurement results.

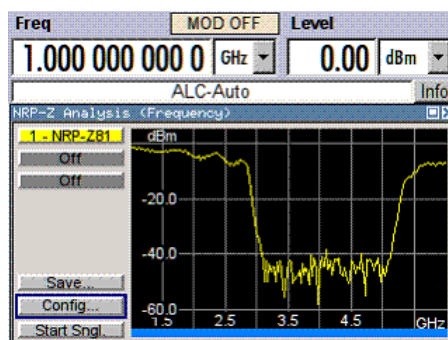

The R&S signal generator supports various graph views, according to the methods of measurement and also additional functions such as the use of markers.

Note: Activate the relevant diagram views in the "REARR list NRP-Z Analysis" dialog, see ["REARR list - Power Analysis"](#) on page 166, and switch to the currently needed view with the aid of the REARR key or STR+<A>.

Markers and the marker list are available in the "NRP-Z Analysis Frequency / Marker" view which is shown in the graph above (see also ["Define Markers"](#) on page 184). Select a marker with the roll key. One click activates the cursor, the second click captures the selected marker to move it to the desired position. Set the focus back to the diagram with a double click on ESC.

The list below the diagram displays the numerical readout of the marker values.

The x-axis of the measurement diagram is freely scalable in the frequency or power range of the generator, the power range for the y-axis is +100 dBm to -200 dBm. In power versus frequency mode, the frequency range of the x-axis is separately scalable. The available time range for power versus time measurements is -1s to +2s.

It is possible to select single or continuous measurement mode in the "Config..." menu. Single starts a single measurement after the trigger, continuous causes a restart of the measurement after each pass. The measurement is triggered by pushing the "Start" button. In continuous mode, the "Start" button is replaced by a "Stop" button after the trigger which can be used to cancel the measurement. A progress bar indicates the current status of the measurement.

In time mode additional triggering is required which is configured in the trigger dialog.

Changing to trace source **Hold** freezes the current trace indication in the diagram.

Some front panel keys are assigned special functions if the power analysis is active (see overview of features and operation in section [chapter 5.3.6.3, "NRP-Z Power Analysis"](#), on page 151):

Marker and Pulse Data Indication - Power Analysis

The marker and pulse data value indication below the measurement diagram is only available for certain views of the diagram. The REARR key or the key combination <STR +A> toggles between the different diagram views (see [chapter 5.3.6.3, "NRP-Z Power Analysis"](#), on page 151). The marker indication in the measurement diagram is activated in the marker dialog, see ["Define Markers"](#) on page 184.

Tip: In remote-control mode, include the markers of the diagram, their values or the pulse data in the hardcopy file.

SCPI command:

`:TRACe[:POWER]:SWEep:MEASurement:MARKer:DISPlay:ANNotation[:STATE]` on page 443

`:TRACe[:POWER]:SWEep:MEASurement:PULSe:DISPlay:ANNotation[:STATE]` on page 444

Buttons

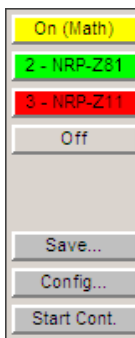

The dialog comprises at the left side a button bar with the four **trace** buttons for sensor assignment.

The "Save" button enables you to directly store the measured data, and the Config button opens the configuration dialog for setting the measurement parameters.

Execute the measurement with the Start/Stop button at the bottom.

Trace Buttons - Power Analysis

The four buttons in the upper left corner of the measurement diagram indicate the sensor assignment to the respective trace. They open the settings dialogs for the traces, see "[Setup Trace](#)" on page 157.

Save... - Power Analysis

Opens the dialog to store a screenshot of the current measurement diagram, see "[Save Hardcopy](#)" on page 185.

Config... - Power Analysis

Opens the dialog to configure the power analysis measurement, see

- "[Configure Measurement](#)" on page 161
- "[Configure Diagram](#)" on page 165
- "[Configure Gate Mode](#)" on page 168
- "[Configure Sensors](#)" on page 170
- "[Configure Pulse Data NRP-Z](#)" on page 174
- "[Configure Trigger](#)" on page 182
- "[Setup Trace](#)" on page 157
- "[Define Markers](#)" on page 184

Start - Power Analysis

Triggers the measurements with the R&S NRP-Zxx power sensors. The measurement results are indicated in the measurement diagram. A progress bar indicates the current status of the measurement.

SCPI command:

`:SENSe[:POWER]:SWEep:INITiate` on page 422

*OPC?

`:TRACe<ch>[:POWER]:SWEep:DATA:POINTs?` on page 440

`:TRACe<ch>[:POWER]:SWEep:DATA:XVALues?` on page 441

`:TRACe<ch>[:POWER]:SWEep:DATA:YVALues?` on page 441

Setup Trace

The measurement data can be current (sensor trace) or stored trace data, either in a file (reference trace) or in a temporary memory (hold trace). Up to four traces can be indicated at one time. On connection, the sensors are automatically detected and assigned to a trace. By default, connected sensors are assigned to the traces in ascending order, i.e. sensor 1 to trace 1, sensor 2 to trace 2 and so on. If the default trace is already used, the sensor has to be assigned manually in the trace dialog.

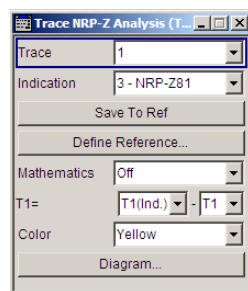

The **reference** and **hold** traces enable you to compare traces. E.g. assign a reference curve to one trace, your measured values to a second one, and switch on display. This feature provides to directly compare results in the graph, or to show deviations in a graph by using the "Mathematics" function.

Example

The current single measurement of sensor 2 which is assigned to trace 2 shall be used as reference trace.

1. Select "Trace 2" with "Indication 2" = NRP-Zx and press the "Save To Ref" button.
2. Select "Trace 1" and "Indication Ref."
3. Press the "Diagram" button, two identical traces are now indicated.
4. Push the "Start single" button and a new measurement cycle with sensor 2 is triggered. The resulting measurement trace can be compared to the former measurement which is visible as reference trace.

Trace

Selects the index of the trace. The source for the trace data is selected below. The trace color for each of the four possible traces is preset but can be changed.

SCPI command:

n.a.

In remote control, the trace is selected by the suffix of keyword `TRACe`.

Indication - Power Analysis

Selects the source for the trace data.

The selection is indicated on the trace button in the measurement diagram.

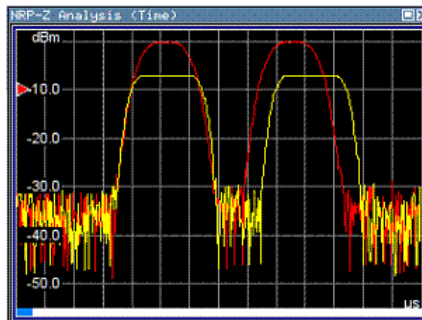

Red = reference or hold trace

Yellow = current measurement trace

"Off" No source is selected, the trace is not indicated.

SCPI command:

`:TRACe<ch>[:POWer]:SWEep:STATe` on page 447

"2 - NRP-Zxx" The current measurement results of the selected power sensor are the source for the trace data. The index at the beginning of the sensor name indicates the used connector, e.g. 2 indicates that the sensor is connected via a USB interface. The data are either continuously updated (continuous measurement) or represent a single measurement cycle (single measurement).

SCPI command:

`:TRACe<ch>[:POWer]:SWEep:STATe` on page 447

`:TRACe<ch>[:POWer]:SWEep:FEED` on page 441

"Ref" Selects the reference trace. The reference trace represents the state of the sensor trace at the moment when it was stored. The reference trace is a static trace that was stored in a file and can be recalled. It is possible to store one reference trace at a time.

SCPI command:

`:TRACe<ch>[:POWer]:SWEep:COPI` on page 440

`:TRACe<ch>[:POWer]:SWEep:FEED` on page 441

`:TRACe<ch>[:POWer]:SWEep:STATe` on page 447

"Hold" Freezes the current trace data. The hold trace is a temporary trace that is available until the NRP power analysis is finished. Freezing the trace of a sensor on one trace and displaying the measurement values of the same sensor on a other trace allows fast comparison between measurements.

SCPI command:

n.a.

(this feature is available for manual control only)

Save to Ref - Trace Power Analysis

Saves the selected trace as reference trace. One reference trace is available at a time.

SCPI command:

[:TRACe<ch>\[:POWER\]:SWEep:COPY](#) on page 440

Define Reference - Trace Power Analysis

Opens a dialog for defining a linear reference curve.

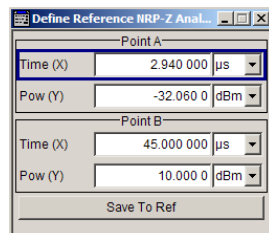

Define the reference curve by entering the coordinates of "Point A" and "Point B".

The reference curve is determined by two value pairs in the cartesian coordinates of the "NRP-Z Analysis" diagram. Depending on the measurement mode, the following values are required:

- Freq (X) / Pow (Y) in "Frequency" mode
Determine the parameters of the frequency reference curve.
[:SENSe\[:POWER\]:SWEep:FREQuency:REFerence:DATA:XVALues](#)
on page 407
[:SENSe\[:POWER\]:SWEep:FREQuency:REFerence:DATA:YVALues](#)
on page 407
- Pow (X) / Pow (Y) in "Power" mode
Enter the x- and y-axis values of the points A and B.
[:SENSe\[:POWER\]:SWEep:POWER:REFerence:DATA:XVALues](#) on page 422
[:SENSe\[:POWER\]:SWEep:TIME:REFerence:DATA:COPY](#) on page 431
- Time (X) / Pow (Y) in "Time" mode
Enter the time values for the x-axis and the corresponding y-axis power values.
[:SENSe\[:POWER\]:SWEep:TIME:REFerence:DATA:XVALues](#) on page 431
[:SENSe\[:POWER\]:SWEep:TIME:REFerence:DATA:YVALues](#) on page 432
- "Save To Ref"
Saves the selected trace as reference trace. One reference trace is available at a time.
[:SENSe\[:POWER\]:SWEep:FREQuency:REFerence:DATA:COPY](#) on page 407
[:SENSe\[:POWER\]:SWEep:POWER:REFerence:DATA:YVALues](#) on page 423
[:SENSe\[:POWER\]:SWEep:TIME:REFerence:DATA:COPY](#) on page 431

The reference curve consists of a certain number of coordinate points, calculated by the number of steps + 1. The first coordinate point starts at Min, and Max is the last. "Step", "Min" and "Max" are determined in the configuration dialog, see "[Configure Measurement](#)" on page 161.

Tip: You can assign the X and Y coordinates of the markers automatically in marker view. By pressing the "Fill Point" button, the function automatically reads the X and Y coordinates from the trace data and derives the intersection point of the selected marker and the trace curve.

Mathematics - Trace Power Analysis

Activates / deactivates the mathematic function.

The function allows to determine the deviation of two test series, either of measurement traces, or also of traces that contain math results or stored reference curves. I.e. you can also assign a math result to an operand for further calculation. Various nested computation steps are possible.

The math operation follows the formula:

$$T\langle ch \rangle_{\text{result}} = T\langle ch \rangle_{\text{Operand1}} - T\langle ch \rangle_{\text{Operand2}}$$

How to proceed:

Determine $T\langle ch \rangle_{\text{Operand1}}$ in the entry field next to "Tx", and then select $T\langle ch \rangle_{\text{Operand2}}$ in the second entry field right to it.

The result (" $T\langle ch \rangle_{\text{result}}$ ") is assigned to the above selected "Trace". If switched on, the graph shows the resulting curve.

Note:

Depending on the type of trace, the instrument automatically sets the appropriate unit on the y-axis:

- "dBm" if it shows only measurement traces.
- "dB" for purely mathematical curves.
- "dB/dBm" ratio scale for mixed display, i.e. measurements and mathematical curves.

Example:

Example of a nested calculation.

- T1 shows the result of the subtraction of the trace ("Trace 1"), and the reference curve.

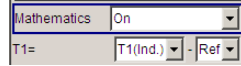

- Trace2 subtracts Ref from T1.

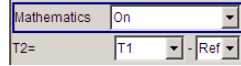

That illustrates the nested calculation, since T1 covers already a math operation.

Note: "(Ind.*)" denotes the currently selected trace.

SCPI command:

[:CALCulate\[:POWER\]:SWEep:FREQuency:MATH<ch>:STATe](#) on page 394

[:CALCulate\[:POWER\]:SWEep:FREQuency:MATH<ch>:SUBTRACT](#) on page 394

[:CALCulate\[:POWER\]:SWEep:POWer:MATH<ch>:STATe](#) on page 395

[:CALCulate\[:POWER\]:SWEep:POWer:MATH<ch>:SUBTRACT](#) on page 395

[:CALCulate\[:POWER\]:SWEep:TIME:MATH<ch>:STATe](#) on page 395

[:CALCulate\[:POWER\]:SWEep:TIME:MATH<ch>:SUBTRACT](#) on page 396

Color - Trace Power Analysis

Selects the color of the trace.

SCPI command:

[:TRACe<ch>\[:POWer\]:SWEep:COLor](#) on page 440

Diagram.. - Power Analysis

Returns to the "NRP-Z Analysis Diagram".

Configure Measurement

To open the "Configure NRP-Z Analysis" dialog, press the "Config..." button. The dialog is divided into several sections. The measurement section provides start and stop values for the sweep, and the corresponding parameters for the selected measurement mode.

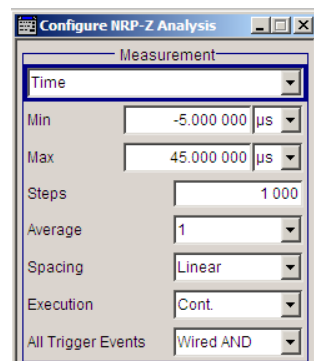
**Measurement Mode - Power Analysis**

Selects the measurement mode.

"Frequency" Power versus frequency measurement (frequency response).

"Power"	Power versus power measurement (power sweep, AM/AM).
"Time"	Power versus time measurement (envelope power measurement as a function of time, NRP trace mode). This is done by sampling power over a time interval and then assigning the internal power values that have been determined to a number of points. This mode also provides gated measurement and pulse data analysis, e.g. with a connected R&S NRP-Z81, and the corresponding graphical display "Gate View" and "Pulse Data View".

SCPI command:

[SENSe\[:POWER\]:SWEep:MODE](#) on page 422

Min - Power Analysis

Enters the minimum frequency/power/time of the measurement.

The available frequency/power range depends on the frequency/power range of the generator and the used power sensor.

The range for the start time is -1s to +1s. Value 0 defines the trigger point. By choosing a negative time value, the trace can be shifted in the diagram.

It is possible, that the measurement cannot be performed over the complete time range because of limitations due to sensor settings. In this case, an error message is output.

If this value is changed for a finished single measurement, only the scaling of the x-axis is changed. This allows to zoom the trace. However, for subsequent measurements the measurement range is changed according to the new setting.

If this value is changed during a continuous measurement, only the scaling of the x-axis is changed for measurement cycles that still were triggered before the change. For subsequent measurement cycles the measurement range is changed according to the new setting.

SCPI command:

[:SENSe\[:POWER\]:SWEep:FREQuency:STARt](#) on page 410

[SENSe\[:POWER\]:SWEep:POWER:STARt](#) on page 427

[SENSe\[:POWER\]:SWEep:TIME:STARt](#) on page 434

Max - Power Analysis

Enters the maximum frequency/power/time of the measurement.

The available frequency/power range depends on the frequency/power range of the instrument and the used power sensor.

The range for the stop time is 0 s to 2 s. Value 0 defines the trigger point.

It is possible, that the measurement cannot be performed over the complete time range because of limitations due to sensor settings. In this case, an error message is output.

If this value is changed for a finished single measurement, only the scaling of the x-axis is changed. This allows to zoom the trace. However, for subsequent measurements the measurement range is changed according to the new setting.

If this value is changed during a continuous measurement, only the scaling of the x-axis is changed for measurement cycles that still were triggered before the change. For subsequent measurement cycles the measurement range is changed according to the new setting.

SCPI command:

`:SENSe[:POWer]:SWEep:FREQuency:STOP` on page 411

`SENSe[:POWer]:SWEep:POWer:STOP` on page 428

`SENSe[:POWer]:SWEep:TIME:STOP` on page 435

Steps - Power Analysis

Enters the number of steps for the sweep. The number of measured points is steps + 1. The number of steps is one of the parameters that define the measurement speed. The higher the number of step, the longer the measurement takes (frequency and power mode).

SCPI command:

`:SENSe[:POWer]:SWEep:FREQuency:STEPS` on page 410

`SENSe[:POWer]:SWEep:POWer:STEPS` on page 428

`SENSe[:POWer]:SWEep:TIME:STEPS` on page 435

Timing - Power Analysis

Frequency and power mode only.

Selects the timing mode of the measurement in frequency and power mode. This parameter is not available in time mode.

"Fast" Fast measurement with an integration time of 2 ms for each measurement step.

"Normal" A longer but more precise measurement (integration time is 20 ms/step).

SCPI command:

`:SENSe[:POWer]:SWEep:FREQuency:TIMing[:MODE]` on page 411

`SENSe[:POWer]:SWEep:POWer:TIMing[:MODE]` on page 428

Average - Power Analysis

Time mode only

Selects the averaging factor in time mode. This parameter is not available in frequency and power mode.

The factor determines how many measurement cycles are used to form a measurement result. Higher averaging counts reduce noise but increase the measurement time. Averaging requires a stable trigger event so that the measurement cycles have the same timing. If factor 1 is selected no averaging is performed.

SCPI command:

`:SENSe[:POWer]:SWEep:TIME:AVERAge[:COUNT]` on page 431

Spacing - Power Analysis

Sets the mode for calculating the sweep steps.

In power versus frequency mode, selection between linear and logarithmic spacing is possible.

- "Linear"
- Power versus frequency
In a linear sweep, the frequency is swept in equidistant steps over the continuous frequency range. The x-axis is a linear frequency axis.
 - Power versus power
The sweeps are performed at constant frequency but with variable generator power that is swept in linear, equidistant steps over a continuous range. The x-axis is a dB-linear power axis.
 - Power versus time
The sweeps are performed at constant frequency and stimulus power. The measurement is repeated over a specified period of time at constant time intervals.
- "Logarithmic" Power versus frequency
In a logarithmic sweep, the frequency is swept in equidistant steps on a logarithmic scale. The x-axis is a logarithmic frequency axis.

SCPI command:

[:SENSe\[:POWer\]:SWEep:FREQuency:SPACing\[:MODE\]](#) on page 410

[:SENSe\[:POWer\]:SWEep:POWer:SPACing\[:MODE\]](#) on page 427

[:SENSe\[:POWer\]:SWEep:TIME:SPACing\[:MODE\]?](#) on page 434

Execution - Power Analysis

Selects single or continuous mode in power analysis.

The measurement is started in the diagram using the "Start" button. During measurement, the "Start" button is replaced by a "Stop" button which can be used to abort the measurement. The progress bar indicates the current status of the measurement.

Note: For time mode an additional trigger is required (see ["Configure Trigger"](#) on page 182).

"Single" Selects single measurement.

"Cont." Selects continuous measurements.

SCPI command:

[:SENSe\[:POWer\]:SWEep:RMODE](#) on page 430

[:SENSe\[:POWer\]:SWEep:FREQuency:RMODE](#) on page 408

[:SENSe\[:POWer\]:SWEep:POWer:RMODE](#) on page 423

[:SENSe\[:POWer\]:SWEep:TIME:RMODE](#) on page 430

All Trigger Events - Power Analysis

"All Trigger Events" determines, whether the measurement data processing starts with a trigger event in one of the sensors (Logical OR), or whether all channels have to be triggered (logical AND). Each sensor evaluates a trigger event according to its setting independently.

This function supports the internal or external trigger modes with multi-channel time measurements.

"Wired AND" When all channels are triggered, the measurement starts.

"Wired OR" The measurement starts when a trigger event occurs.

SCPI command:

[:SENSe\[:POWER\]:SWEep:TIME:TEVents](#) on page 435

Configure Diagram

The "Configure NRP-Z Analysis" dialog is divided into several sections. The diagram area covers the parameters for scaling the y-axis and the appearance of the diagram.

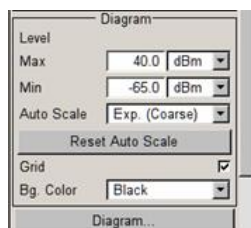

Min - Max y-Axis - Power Analysis

Selects the minimum and maximum value of the y-axis.

SCPI command:

[:SENSe\[:POWER\]:SWEep:FREQuency:YSCale:MAXimum](#) on page 412

[:SENSe\[:POWER\]:SWEep:FREQuency:YSCale:MINimum](#) on page 413

[SENSe\[:POWER\]:SWEep:POWER:YSCale:MAXimum](#) on page 429

[SENSe\[:POWER\]:SWEep:POWER:YSCale:MINimum](#) on page 430

[SENSe\[:POWER\]:SWEep:TIME:YSCale:MAXimum](#) on page 437

[SENSe\[:POWER\]:SWEep:TIME:YSCale:MINimum](#) on page 437

Auto Scale - Power Analysis

Activates/deactivates autoscaling of the y-axis of the diagram. The Auto Scale function adjusts the scale divisions so that the entire trace fits into the diagram area.

"Off" Auto scale is deactivated. Switching from activated to deactivated, the scaling is maintained.

"Exp. (Course/
Fine)" Auto scale is activated. Automatically selects the appropriate scaling of the y-axis so that the trace is always visible. The range is expanded when a value is out of the right or the left end-of-scale value. The step width is 5 dB for selection "Exp. (Coarse)" and variable in the range of 0.2 db to 5 dB for selection "Exp. (Fine)".

"Flt. (Coarse/
Fine)" Auto scale is activated, i.e. this parameter automatically selects the appropriate scaling of the y-axis so that the trace is always visible. The range is either expanded, when a value is out of the right/left end-of-scale value or it is reduced when the trace fits into a smaller scale area. The step width is 5 dB for selection "Flt. (Coarse)" and variable in the range of 0.2 db to 5 dB for selection "Flt. (Fine)".

SCPI command:

[:SENSe\[:POWER\]:SWEep:FREQuency:YSCale:AUTO](#) on page 411

[SENSe\[:POWER\]:SWEep:POWER:YSCale:AUTO](#) on page 428

[SENSe\[:POWER\]:SWEep:TIME:YSCale:AUTO](#) on page 436

Reset Auto Scale - Power Analysis

Resets the scaling of the y-axis to suitable values after the use of auto scaling in the expanding mode. For this mode, the Y scale might get too expanded because of temporarily high power values. The reset function resets the diagram again, to also indicate smaller power values.

SCPI command:

`:SENSe[:POWer]:SWEep:FREQuency:YSCale:AUTO:RESet` on page 412

`SENSe[:POWer]:SWEep:POWer:YSCale:AUTO:RESet` on page 429

`SENSe[:POWer]:SWEep:TIME:YSCale:AUTO:RESet` on page 436

Grid - Power Analysis

Activates/deactivates the indication of a grid in the diagram area.

SCPI command:

`:DISPlay[:WINDow][:POWer]:SWEep:GRID:STATe` on page 396

Bg Color - Power Analysis

Selects the background color of the diagram, black or white. The background color is also effective for the hardcopy of the diagram.

SCPI command:

`:DISPlay[:WINDow][:POWer]:SWEep:BACKground:COLor` on page 396

REARR list - Power Analysis

The "REARR list..." button in the middle section opens the dialog for selection of diagram views. This function provides to activate only the required "Views" on the checkboxes to the right. REARR or STRG+<A> switches between all views that are activated in this dialog.

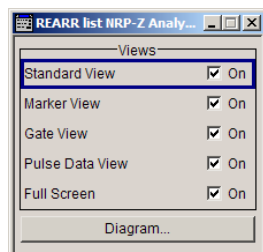

Viewing modes of frequency power and level sweep timing measurements:

- "Standard View:" shows the graph and the button bar at the left

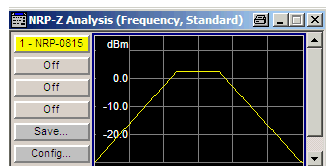

- "Marker View:" shows the graph and the corresponding marker values at the bottom

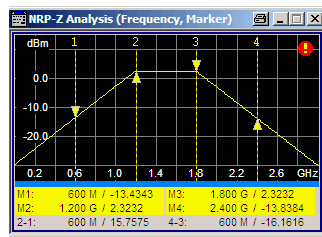

- "Full Screen:" shows the graph in fullscreen, and fades out buttons and list values

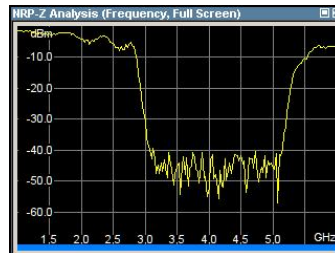

Viewing modes of time trace and pulse data measurements:

- "Gate View:" shows the graph with the corresponding gate data
Gate view provides indicating time trace measurements, as e.g. the peak envelope power of the RF signal.

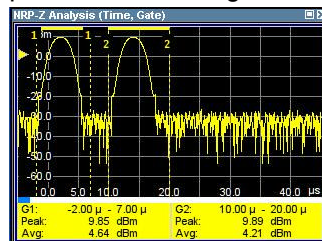

Note: This view is selectable in time mode, since gate measurement is a function of time.

- "Pulse Data View:" shows the graph and the corresponding pulse data
Pulse data view indicates pulse data measurement results of the R&S NRP-Z8x sensor family.

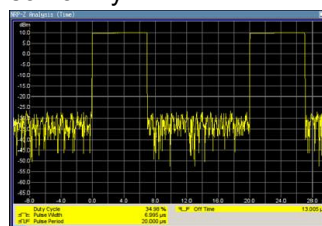

Note: This view is selectable in time mode, since pulse data measurement is a function of time.

Note: The toggle function always switches sequentially between the activated views. When you disable a view that is currently shown, the instrument automatically switches to the next active view.

At least one view must be active, i.e. the final active view cannot be switched off.

SCPI command:

```
:TRACe[:POWer]:SWEep:MEASurement:STANdard:DISPlay:ANNotation[:STATE] on page 444
```

```
:TRACe[:POWer]:SWEep:MEASurement:MARKer:DISPlay:ANNotation[:STATE] on page 443
```

```
:TRACe[:POWer]:SWEep:MEASurement:GATE:DISPlay:ANNotation[:STATE] on page 442
```

```
:TRACe[:POWer]:SWEep:MEASurement:PULSe:DISPlay:ANNotation[:STATE] on page 444
```

```
:TRACe[:POWer]:SWEep:MEASurement:FULLscreen:DISPlay:ANNotation[:STATE] on page 442
```

Pressing the "Diagram..." button returns to the "NRP-Z Analysis" diagram.

Gate Mode - Power Analysis

The "Gate Mode..." button opens the subdialog for the gate mode settings (see "Configure Gate Mode" on page 168).

Diagram.. - Power Analysis

Returns to the "NRP-Z Analysis Diagram".

Configure Gate Mode

The "Configure NRP-Z Analysis" dialog is divided into several sections. The "Gate Mode..." button in the middle section opens the dialog for time gate settings.



For time measurement mode only.

Almost all R&S NRP sensors also support time gated measurements of peak and average power (see the data sheet or operating manual of the respective sensor). Two user-configurable gates can be assigned to one of the traces. Both gates are active at the same time. The values are calculated from the trace data, the time resolution is determined by the resolution of the sensor. An external trigger signal or signal triggering is required for synchronization.

The following graph shows two measurement examples, one with separated gates, and another one with overlapping gates.

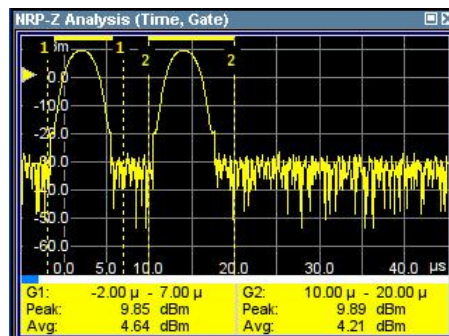

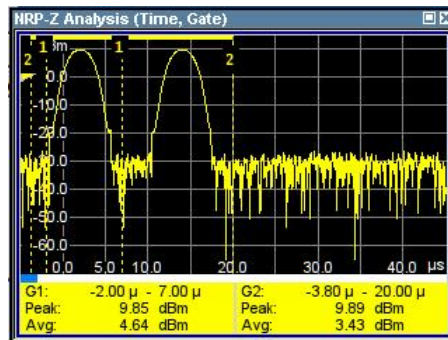

The start and stop time of the gates are indicated as gate markers, a bar between the start and stop marker shows the gate length. The indication state of the gate borders and measurement values is only available for certain diagram views which are switched with the "REARR" key. The "REARR list NRP-Z Analysis dialog" dialog provides a selection of views, between which is toggled (see "REARR list - Power Analysis" on page 166).

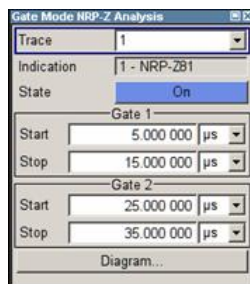

In the remote control mode, commands for setting the indication state differ from the commands for reading the measurement values.

- Command that defines the indication state for the diagram and for hardcopy:**
`:TRACe[:POWER]:SWEep:MEASurement:GATE:DISPlay:ANNotation[:STATE]` on page 442
- Commands that query the measured values:**
`:CALCulate[:POWER]:SWEep:TIME:GATE<ch>AVERAge?` on page 392 queries the measured average power.
`:CALCulate[:POWER]:SWEep:TIME:GATE<ch>MAXimum?` on page 393 queries the measured peak power.

Trace - Gate

Selects the trace to which the gates are assigned. The sensor assignment to the respective trace is performed in the measurement diagram (trace buttons). The two gates are assigned to the same trace.

SCPI command:

`:CALCulate[:POWER]:SWEep:TIME:GATE<ch>:FEED` on page 393

Indication

(time measurement mode only)

Indicates the type of R&S NRP power sensor assigned to the selected trace. This field is automatically updated if the sensor is connected or disconnected. Additionally, this sensor is indicated on the trace button in the measurement diagram.

SCPI command:

n.a.

State - Gate

Enables time gated measurement. The measurement is started with the "Start" button in the main measurement diagram. Both gates are active at one time.

The gate borders and the measurement values (average and peak power) are indicated in/below the measurement diagram. The indication is only available for certain diagram views which are switched with the "Rearrange" key.

SCPI command:

`:CALCulate[:POWER]:SWEep:TIME:GATE<ch>:STATe` on page 394

`:CALCulate[:POWER]:SWEep:TIME:GATE<ch>AVERAge?` on page 392

`:CALCulate[:POWER]:SWEep:TIME:GATE<ch>MAXimum?` on page 393

`:TRACe[:POWER]:SWEep:MEASurement:GATE:DISPlay:ANNotation[:STATe]` on page 442

Start / Stop - Gate

Sets the start and the stop times for the respective gate.

SCPI command:

`:CALCulate[:POWER]:SWEep:TIME:GATE<ch>START` on page 393

Diagram... - Power Analysis

Returns to the "NRP-Z Analysis" Diagram.

Configure Sensors

The "Configure NRP-Z Analysis" dialog is divided into several sections. The power sensor area additionally provides specific parameters for the power sensor. This part of the dialog might differ from the following description depending on the sensor used. Refer to the manual of the power sensor in this case.

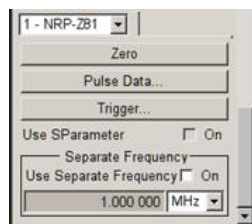

The "Pulse Data..." button is displayed only for measurement mode time and if an R&S NRP-Z81 power sensor is connected.

Power Sensor - Power Analysis

Selects the power sensor to be set if more than one sensor is connected to the instrument.

SCPI command:

n.a.

In remote control the sensor is selected via the numeric suffix in the sense key word of the command, e.g. `SENSe2:POWer:SWEep:....`

Zero - Power Analysis

Activates the auto zero function.

Zeroing calibrates the external power sensor by adjusting its reading at zero signal power. For this purpose, the RF power source must be switched off or disconnected from the sensor (see tips below). R&S power sensors automatically detect the presence of any significant input power. This aborts zeroing and generates an error message. Zeroing can take a few seconds, depending on the sensor model; refer to the documentation of your external power sensor for more information.

Tips for zeroing

Zeroing should be performed:

- During warm-up after switching on or connecting the instrument
- After a substantial change of the ambient temperature
- After fastening the power sensor module to an RF connector at high temperature
- After several hours of operation
- When very low-power signals are to be measured, e.g. less than 10 dB above the lower measurement limit.
- Switch off the RF power source for zeroing; do not disconnect it from the power sensor. In this way you will maintain the thermal equilibrium, and zeroing will also compensate for the noise superimposed on the measured signal (e.g. from a broadband amplifier).

SCPI command:

[SENSe<ch>\[:POWer\]:ZERO](#) on page 438

Pulse Data... - Power Analysis

Only for measurement mode time and if an R&S NRP-Z81 power sensor is connected.

Opens the "Pulse Data NRP-Z-Analysis" dialog for configuring the parameters for pulse data analysis (see "[Configure Pulse Data NRP-Z](#)" on page 174).

SCPI command:

n.a.

Trigger... - Power Analysis

Only for measurement mode time.

Opens a settings dialog to set the trigger for time measurement mode, see "[Configure Trigger](#)" on page 182.

Use S-Parameter - Power Analysis

Activates the use of the s-parameters correction data of the connected power sensor. For sensors with attenuator this checkbox is automatically checked.

Refer also to the manual of the connected R&S NRP power sensor for a description on how to use the s-parameters table.

SCPI command:

`SENSe<ch>[:POWER]:CORRection:SPDevice:STATe` on page 400

Level Offset State- Power Analysis

Activates a level offset at the sensor input. Enter the appropriate value in the entry field on the right, see [Level Offset - Power Analysis](#).

SCPI command:

`:SENSe<ch>[:POWER]:SWEep:FREQUency[:SENSor]:OFFSet:STATe`
on page 408

`:SENSe<ch>[:POWER]:SWEep:POWER[:SENSor]:OFFSet:STATe` on page 424

`:SENSe<ch>[:POWER]:SWEep:TIME[:SENSor]:OFFSet:STATe` on page 425

Level Offset - Power Analysis

Enters the level offset at the sensor input. To take the value into account, activate the offset with "[Level Offset State- Power Analysis](#)" on page 172.

SCPI command:

`:SENSe<ch>[:POWER]:SWEep:FREQUency[:SENSor]:OFFSet` on page 408

`:SENSe<ch>[:POWER]:SWEep:POWER[:SENSor]:OFFSet` on page 423

`:SENSe<ch>[:POWER]:SWEep:TIME[:SENSor]:OFFSet` on page 424

Use Separate Frequency- Power Analysis

This setting is offered for measurements with DUTs that change the measurement frequency (e.g. modulators), thus changing the input frequency of the sensor.

The dialog differs depending on the measurement modes:

- Power versus frequency measurement
Activates the use of a different frequency range other than the set signal generator frequency range for the measurement. The separate minimum and maximum frequency values are entered below.
The x-scale of the diagram can be adjusted to the separate frequency range with functions "Use as X Scale" and "Map to X Scale".

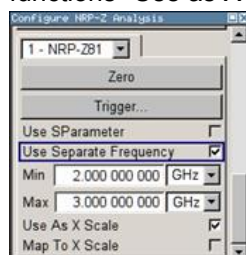

- Power versus power measurement / Power versus time measurement
Activates the use of a different frequency other than the set signal generator frequency for the measurement. The separate frequency value is entered in the entry window below.

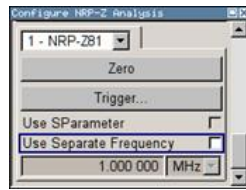

SCPI command:

`:SENSe<ch>[:POWER]:SWEep:FREQuency[:SENSor]:SRANge[:STATe]`
on page 409

`SENSe<ch>[:POWER]:SWEep:POWER[:SENSor]:SFRequency:STATe`
on page 424

`SENSe<ch>[:POWER]:SWEep:POWER[:SENSor]:SFRequency` on page 424

`SENSe<ch>[:POWER]:SWEep:TIME[:SENSor]:SFRequency:STATe` on page 432

`SENSe<ch>[:POWER]:SWEep:TIME[:SENSor]:SFRequency` on page 432

Min Frequency - Power Analysis

Power versus frequency measurement active Use Separate Frequency only.

Enters the minimum frequency of the measurement.

SCPI command:

`:SENSe<ch>[:POWER]:SWEep:FREQuency[:SENSor]:SRANge:START`
on page 409

Max Frequency - Power Analysis

Power versus frequency measurement active Use Separate Frequency only.

Enters the maximum frequency of the measurement.

SCPI command:

`:SENSe<ch>[:POWER]:SWEep:FREQuency[:SENSor]:SRANge:STOP`
on page 409

Use as X Scale - Power Analysis

Measurement Mode Frequency only.

Activates the use of the separate frequency min and max values for the scaling of the x-axis. Thus, the trace for this sensor is visible in the diagram, especially for frequency ranges that differ substantially from the generator settings.

If more than one sensor is active and uses separate frequency, this options is only available for one sensor. To indicate the traces of the other sensors, function "Map to X Scale" has to be used.

SCPI command:

n.a.

Map to X Scale - Power Analysis

Mode Frequency and active Use Separate Frequency only.

Maps the trace of a sensor that uses separate frequency to the current scaling of the diagram. Usually the scale is determined by the set frequency range of the generator. If more than one sensor is active and uses separate frequency the scale can also be determined by the separate frequency range of one of the other sensors.

SCPI command:

n.a.

Configure Pulse Data NRP-Z



For time measurement mode and power sensor R&S NRP-Z81 only.

The power sensors R&S NRP-Z81 enable pulse data analysis in measurement mode time. All important pulse parameters are measured after setting the threshold levels. The following graph shows most of these parameters:

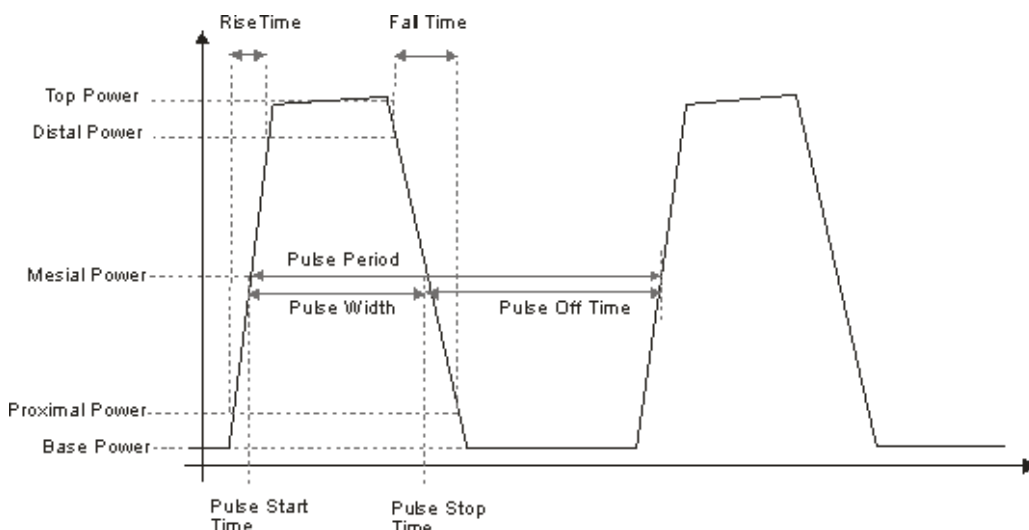

The sensor calculates the pulse parameters from each measurement. The sensor delivers the results to the R&S signal generator.

The "Pulse Data" button opens the submenu to configure and enable pulse data analysis:

- The "Pulse Data NRP-Z- Analysis" dialog is divided into several sections. In the upper section the trace is selected and the pulse data analysis enabled. For information on traces and the measurement data on traces refer to ["Setup Trace"](#) on page 157.
- The "Thresholds" section covers the thresholds for detecting time values of a pulsed signal. Thresholds are used to calculate the time parameters. The thresholds can either be related to power or voltage. For information on parameters and terms refer to ["Voltage / Power Related - Pulse Data Analysis"](#) on page 176, ["Mesial - Pulse Data Analysis"](#) on page 177 and ["Proximal - Pulse Data Analysis"](#) on page 177.
- The "Notifications" section covers Duty Cycle, Pulse Width, Pulse Period and Pulse Off Time (see ["Notifications - Pulse Data Analysis"](#) on page 177).

- The "Transition Times" section covers Rise Time, Pulse Start Time, Overshoot for the rising or falling edges, Fall Time and Pulse Stop Time (see "[Transition Times - Pulse Data Analysis](#)" on page 178).
- The "Signal Power" section covers Minimal Power, Peak Power and Average Power (see "[Signal Power - Pulse Data Analysis](#)" on page 180).
- The "Pulse Power" section covers Top Power and Base Power, and Mesial Proximal and Distal Power (see "[Pulse Power - Pulse Data Analysis](#)" on page 181).

The indication state of the parameters also affects the hardcopy function. Storing the measurement diagram as hardcopy includes the parameters selected in this dialog. For information on storing measurement data refer to "[Save Hardcopy](#)" on page 185.



A total of 6 parameters can be indicated at one time. Structured hierarchically, trace 1 features top priority and trace 4 is addressed with the lowest weighting. This means that only the first 6 checked parameters are indicated, starting with the settings of trace 1.

The pulse data is only visible for certain zoom levels of the diagram. The REARRANGE key or the key combination <STR+A> on an external keyboard toggles between the different zoom levels.

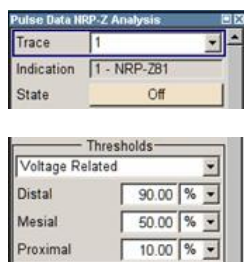

In the remote control mode, commands for setting the indication state differ from the commands for reading the values of the corresponding pulse data parameters.

In the description of the checkboxes, the different remote control commands are listed as shown in the example below:

- Commands that define the indication state for the diagram and for hardcopy:
`:TRACE<ch>[:POWER]:SWEep:MEASurement:PULSe:DCYCLE:DISPlay:ANNotation[:STATe]` on page 445
 activates indication of the measured duty cycle.
`:TRACE<ch>[:POWER]:SWEep:MEASurement:POWER:PULSe:TOP:DISPlay:ANNotation[:STATe]` on page 445
 activates indication the measured top level.
- Commands that query the measured values:
`:TRACe<ch>[:POWER]:SWEep:MEASurement:PULSe:DCYCLE?` on page 443
 queries the measured duty cycle.
`:TRACe<ch>[:POWER]:SWEep:MEASurement:POWER:PULSe:TOP?`
 on page 443
 queries the measured top level.

Trace

Selects the index of the trace. The source for the trace data is selected below. The trace color for each of the four possible traces is preset but can be changed.

SCPI command:

n.a.

In remote control, the trace is selected by the suffix of keyword `TRACe`.

Indication

(time measurement mode only)

Indicates the type of R&S NRP power sensor assigned to the selected trace. This field is automatically updated if the sensor is connected or disconnected. Additionally, this sensor is indicated on the trace button in the measurement diagram.

SCPI command:

n.a.

State - Pulse Data Analysis

Enables pulse data analysis. The measurement is started with the "Start" button in the main measurement diagram.

SCPI command:

`:SENSe<ch>[:POWER]:SWEep:TIME[:SENSor]:PULSe:STATe` on page 425

Voltage / Power Related - Pulse Data Analysis

Selects how the threshold parameters are calculated, either voltage related or power related. The voltage-related parameters represent the normal case, as the usual representation when defining the pulse parameters (rise/fall time, pulse width) is U(t). To achieve a display with equivalent power-related values, the voltage-related threshold values must be converted (squared) (see example in table below).

	Distal	Mesial	Proximal
Voltage related:	90%	50%	10%
Power related:	81%	25%	1 %
log. Scale (e.g.): (approx., difference between top- base power > 30 dB)	-0.9dB	-6dB	-20dB

SCPI command:

`SENSe<ch>[:POWER]:SWEep:TIME[:SENSor]:PULSe:THReshold:BASE`
on page 425

`:TRACe<ch>[:POWER]:SWEep:PULSe:THReshold:BASE?` on page 446

Distal - Pulse Data Analysis

Sets the upper reference level in terms of percentage of the overall pulse level (power or voltage related). The distal power defines the end of the rising edge and the start of the falling edge of the pulse.

SCPI command:

```
:SENSe<ch>[:POWer]:SWEep:TIME[:SENSor]:PULSe:THReshold:POWer:
HREFerence on page 426
:TRACe<ch>[:POWer]:SWEep:PULSe:THReshold:POWer:HREFerence?
on page 446
```

Mesial - Pulse Data Analysis

Sets the medial reference level in terms of percentage of the overall pulse level (power or voltage related). This level is used to define the pulse width (τ) and pulse period.

SCPI command:

```
:SENSe<ch>[:POWer]:SWEep:TIME[:SENSor]:PULSe:THReshold:POWer:
REFerence on page 426
:TRACe<ch>[:POWer]:SWEep:PULSe:THReshold:POWer:REFerence?
on page 447
```

Proximal - Pulse Data Analysis

Sets the lower reference level in terms of percentage of the overall pulse level (power or voltage related).

The proximal power defines the start of the rising edge and the end of the falling edge of the pulse.

SCPI command:

```
:SENSe<ch>[:POWer]:SWEep:TIME[:SENSor]:PULSe:THReshold:POWer:
LREFerence on page 427
:TRACe<ch>[:POWer]:SWEep:PULSe:THReshold:POWer:LREFerence?
on page 447
```

Notifications - Pulse Data Analysis

Selects the pulse parameters to be indicated below the measurement diagram.

Note: The "Rearrange" key or the key combination <STR+A> toggle between the diagram views.



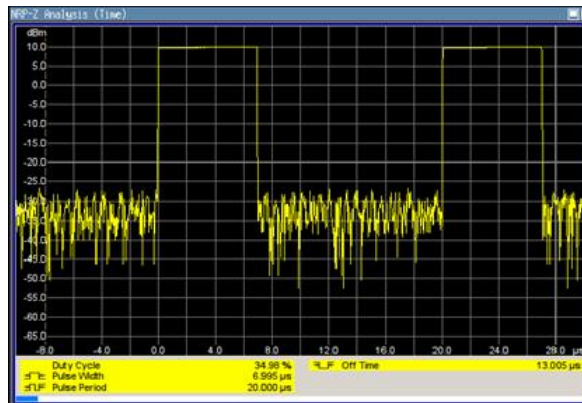

"Duty Cycle" Indicates the ratio between the pulse duration (τ) and the pulse period (T) of the measured pulse signal in per cent:

$$\text{Duty Cycle} = (\text{pulse duration} / \text{pulse period}) * 100$$

SCPI command:

`:TRACE<ch>[:POWER]:SWEep:MEASurement:PULSe:DCYCLe:DISPlay:ANNOtation[:STATe]` on page 445

`:TRACe<ch>[:POWER]:SWEep:MEASurement:PULSe:DCYCLe?` on page 443

"Pulse Width" Indicates the pulse duration of the pulse data measurement in seconds.

SCPI command:

`:TRACE<ch>[:POWER]:SWEep:MEASurement:PULSe:DURation:DISPlay:ANNOtation[:STATe]` on page 445

`:TRACe<ch>[:POWER]:SWEep:MEASurement:PULSe:DURation?` on page 443

"Pulse Period" Indicates the time the pulse signal needs to complete one cycle.

SCPI command:

`:TRACE<ch>[:POWER]:SWEep:MEASurement:PULSe:PERiod:DISPlay:ANNOtation[:STATe]` on page 445

`:TRACe<ch>[:POWER]:SWEep:MEASurement:PULSe:PERiod?` on page 443

"Pulse Off Time" Determines the time the pulse signal is low, i.e. as long as the signal level is below the proximal value.

SCPI command:

`:TRACE<ch>[:POWER]:SWEep:MEASurement:PULSe:SEPARation:DISPlay:ANNOtation[:STATe]` on page 445

`:TRACe<ch>[:POWER]:SWEep:MEASurement:PULSe:SEPARation?` on page 443

Transition Times - Pulse Data Analysis

Selects the transition parameters of the pulse signal to be indicated below the measurement diagram.

The R&S NRP-Z sensor searches for the first rising edge and the first falling edge in the trace.

Note: The "Rearrange" key or the key combination <STR+A> toggle between diagram views.

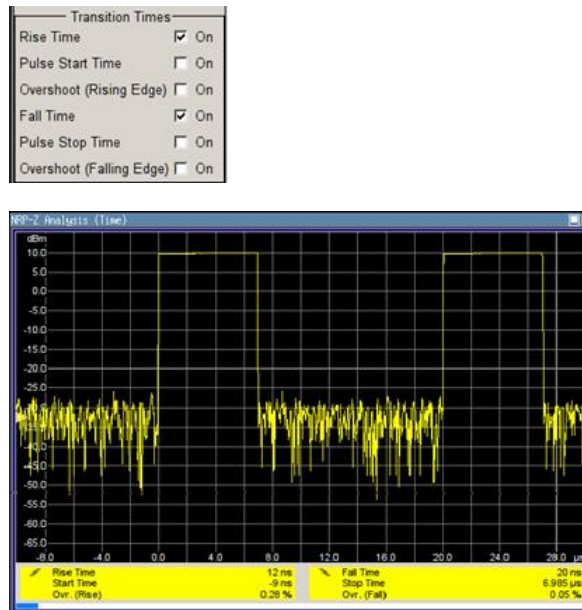

"Rise Time / Fall Time" Display the time the signal requires from crossing low reference until it reaches high reference level and vice versa.

SCPI command:

```
:TRACE<ch>[:POWER]:SWEep:MEASurement:TRANSition:POSitive:
DURation:DISPlay:ANNotation[:STATe] on page 445
```

```
:TRACe<ch>[:POWER]:SWEep:MEASurement:TRANSition:POSitive:
DURation? on page 443
```

```
:TRACE<ch>[:POWER]:SWEep:MEASurement:TRANSition:NEGative:
DURation:DISPlay:ANNotation[:STATe] on page 445
```

```
:TRACe<ch>[:POWER]:SWEep:MEASurement:TRANSition:NEGative:
DURation? on page 443
```

"Pulse Start Time / Pulse Stop Time" Display the time when the pulse signal crosses the medial reference level.

SCPI command:

```
:TRACE<ch>[:POWER]:SWEep:MEASurement:TRANSition:POSitive:
OCCurrence:DISPlay:ANNotation[:STATe] on page 445
```

```
:TRACe<ch>[:POWER]:SWEep:MEASurement:TRANSition:POSitive:
OCCurrence? on page 443
```

```
:TRACE<ch>[:POWER]:SWEep:MEASurement:TRANSition:NEGative:
OCCurrence:DISPlay:ANNotation[:STATe] on page 445
```

```
:TRACe<ch>[:POWER]:SWEep:MEASurement:TRANSition:NEGative:
OCCurrence? on page 443
```

"Overshoot (Rising Edge / Falling Edge)" Display the maximum value of the pulse signal following a rising transition and the minimum value of the signal after a falling transition, respectively.

Overshoot values are given in per cent of the pulse amplitude as shown below:

- $\text{Overshoot}(\text{pos}) = 100 \cdot (\text{maximum} - \text{top level}) / (\text{top level} - \text{base level})$
- $\text{Overshoot}(\text{neg}) = 100 \cdot (\text{base level} - \text{minimum}) / (\text{top level} - \text{base level})$

SCPI command:

`:TRACE<ch>[:POWER]:SWEep:MEASurement:TRANSition:POSitive:OVERshoot:DISPlay:ANNotation[:STATe]` on page 445

`:TRACe<ch>[:POWER]:SWEep:MEASurement:TRANSition:POSitive:OVERshoot?` on page 443

`:TRACE<ch>[:POWER]:SWEep:MEASurement:TRANSition:NEGative:OVERshoot:DISPlay:ANNotation[:STATe]` on page 445

`:TRACe<ch>[:POWER]:SWEep:MEASurement:TRANSition:NEGative:OVERshoot?` on page 443

Signal Power - Pulse Data Analysis

Selects the power parameters of the pulse signal to be indicated below the measurement diagram.

Note: The REARRANGE key or the key combination <STR+A> toggle between the diagram views.

Signal Power	
Peak Power	<input type="checkbox"/> On
Average Power	<input type="checkbox"/> On
Minimal Power	<input type="checkbox"/> On

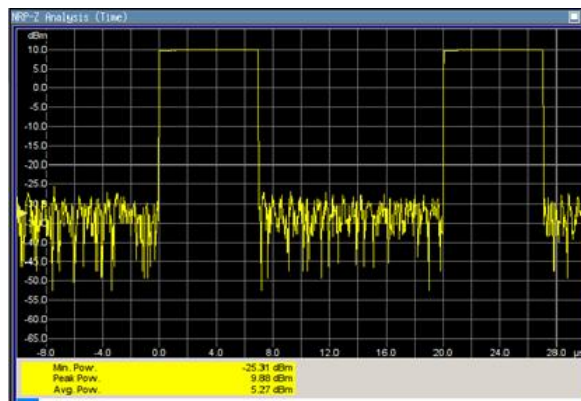

"Minimal / Peak / Average Power" display the minimum, the maximum and the average power of the pulse signal in dBm.

SCPI command:

`:TRACE<ch>[:POWER]:SWEep:MEASurement:POWER:MINimum:DISPlay:`

`ANNotation[:STATe]` on page 445

`:TRACe<ch>[:POWER]:SWEep:MEASurement:POWER:MINimum?` on page 443

`:TRACE<ch>[:POWER]:SWEep:MEASurement:POWER:MAXimum:DISPlay:`

`ANNotation[:STATe]` on page 445

`:TRACe<ch>[:POWER]:SWEep:MEASurement:POWER:MAXimum?` on page 443

`:TRACE<ch>[:POWER]:SWEep:MEASurement:POWER:AVERAge:DISPlay:`

`ANNotation[:STATe]` on page 445

`:TRACe<ch>[:POWER]:SWEep:MEASurement:POWER:AVERAge?` on page 443

Pulse Power - Pulse Data Analysis

Selects which pulse power parameters are indicated in the diagram (pulse data view only).

Note: The "Rearrange" key or the key combination "<STR+a>" toggles between the diagram views.

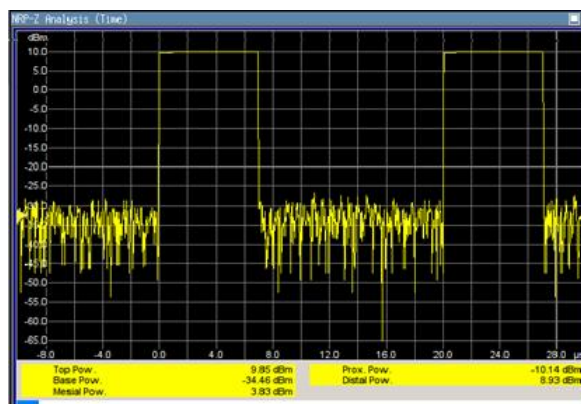

"Top / Base Power" Indicate the pulse top and base level of the analyzed signal in dBm.

SCPI command:

`:TRACE<ch>[:POWER]:SWEep:MEASurement:POWER:PULSe:TOP:DISPlay:`

`ANNotation[:STATe]` on page 445

`:TRACe<ch>[:POWER]:SWEep:MEASurement:POWER:PULSe:TOP?` on page 443

`:TRACE<ch>[:POWER]:SWEep:MEASurement:POWER:PULSe:BASE:DISPlay:`

`ANNotation[:STATe]` on page 445

`:TRACe<ch>[:POWER]:SWEep:MEASurement:POWER:PULSe:BASE?` on page 443

"Distal / Mesial / Proximal Power" Display the absolute power values of the medial, low and high reference level in dBm.

SCPI command:

[:TRACE<ch>\[:POWER\]:SWEep:MEASurement:POWER:LREference:DISPlay:ANNOtation\[:STATe\]](#) on page 445

[:TRACe<ch>\[:POWER\]:SWEep:MEASurement:POWER:LREference?](#) on page 443

[:TRACE<ch>\[:POWER\]:SWEep:MEASurement:POWER:HREference:DISPlay:ANNOtation\[:STATe\]](#) on page 445

[:TRACe<ch>\[:POWER\]:SWEep:MEASurement:POWER:HREference?](#) on page 443

Diagram.. - Power Analysis

Returns to the "NRP-Z Analysis Diagram".

Configure Trigger

The "Trigger..." button opens the "Trigger NRP-Z Analysis" dialog. The button is only active for time measurement mode. For this mode, the measurement start has to be known to the sensor as the measurement is controlled by the sensor.

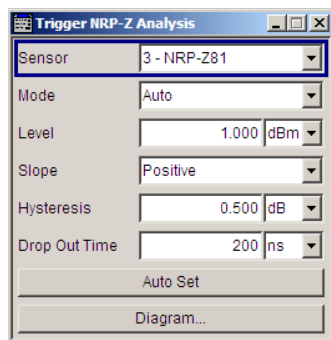

Power Sensor - Power Analysis

Selects the power sensor to be set if more than one sensor is connected to the instrument.

SCPI command:

n.a.

In remote control the sensor is selected via the numeric suffix in the sense key word of the command, e.g. `SENSe2:POWER:SWEep:...`

Mode - Power Analysis

Selects if the measurement is free running, or starts only after an internal or external trigger event.

SCPI command:

[SENSe<ch>\[:POWER\]:SWEep:TIME\[:SENSor\]:TRIGger:SOURce](#) on page 434

Level - Power Analysis

Sets the trigger threshold. This setting is also possible by means of the trigger marker on the left side of the diagram.

SCPI command:

[SENSe<ch>\[:POWER\]:SWEep:TIME\[:SENSor\]:TRIGger:LEVEl](#) on page 433

Hysteresis - Power Analysis

Sets the hysteresis of the internal trigger threshold. Hysteresis is the magnitude (in dB) the trigger signal level must drop below the trigger threshold (positive trigger slope) before triggering can occur again.

SCPI command:

`SENSe<ch>[:POWer]:SWEep:TIME[:SENSor]:TRIGger:HYSTeresis`

on page 433

Drop out Time - Power Analysis

Determines the minimum time for which the signal must be below (above) the power level defined by "Level" and "Hysteresis" before triggering can occur again. This prevents the trigger system from being activated too early if the trigger threshold is briefly underranged or exceeded.

The dropout time parameter is useful when dealing with, for example, GSM signals with several active slots. When performing a measurement in sync with the signal, a trigger event is to be produced at A, but not at B or C. As the RF power between the slots is below the threshold defined by "Level" and "Hysteresis", the trigger hysteresis alone cannot prevent triggering at B or at C. This is why the dropout time parameter is selected to be greater than the time elapsed between points E and B and between F and C, but less than the time elapsed between G and A. This ensures that triggering will take place at A.

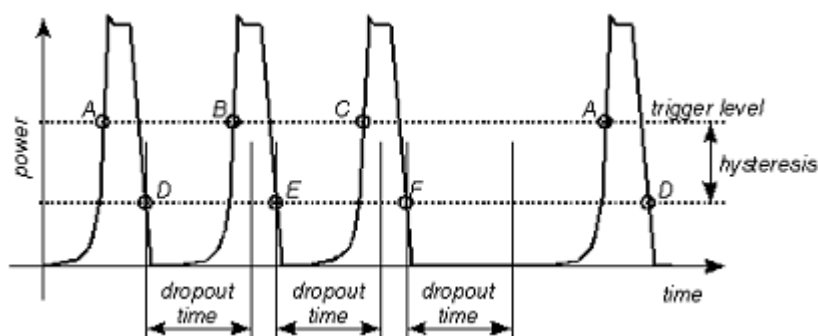

As the mechanism associated with the dropout time parameter is reactivated whenever the trigger threshold is crossed, unambiguous triggering can also be obtained for many complex signals. By contrast, all triggering is suppressed during the hold-off time. For the example described, this would mean that although stable triggering conditions could be obtained with a suitable hold-off time (regular triggering at the same point), it would not be possible to set exclusive triggering at A.

SCPI command:

`SENSe<ch>[:POWer]:SWEep:TIME[:SENSor]:TRIGger:DTIME` on page 433

Auto Set - Power Analysis

Sets the trigger level, the hysteresis and the drop out time to default values.

SCPI command:

`SENSe<ch>[:POWer]:SWEep:TIME[:SENSor]:TRIGger:AUTO` on page 432

Diagram.. - Power Analysis

Returns to the "NRP-Z Analysis Diagram".

Define Markers

Readout and comparison of particular values of the traces is possible by means of four markers. The markers can be edited either in the diagram or in the "Marker" dialog that is called with the SETUP key in the "NRP-Z Analysis" diagram.

In the "Marker" dialog, the marker can be made visible ("Visible") and assigned to a certain trace ("Trace"). The exact position still has to be defined in the diagram.



Markers and the marker list are available in the medium zoom level which is shown in the graph below. To access the markers activate the "NRP-Z Analysis (Time, Marker)" view with the "Rearrange" key. The markers are moved by means of the cursor and the roll key to the desired trace position. One click activates the marker cursor, the second click attaches the cursor to the selected marker which now can be moved to the desired position. Two clicks on the ESC key set the focus back to the diagram. The position of a active markers are indicated in the marker list.

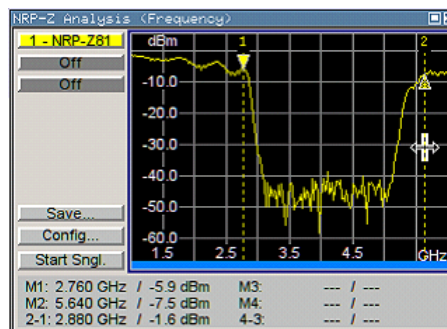

Marker - Power Analysis

Selects the marker to be configured.

SCPI command:

n.a.

Visible - Power Analysis

Selects if the marker and the marker list is visible in the diagram.

SCPI command:

n.a.

Trace - Power Analysis

Selects the trace to which the marker is assigned.

SCPI command:

n.a.

Diagram.. - Power Analysis

Returns to the "NRP-Z Analysis" diagram.

SCPI command:

n.a.

Save Hardcopy

The "Save ..." button in the "Power Analysis" diagram opens a dialog to store a screenshot of the current measurement diagram. The current screen shot is stored as indicated, i.e. with or without marker indication. The different diagram views are toggled with the "Rearrange" key or the key combination <STR+A> on an external keyboard (see overview of features and operation in [chapter 5.3.6.3, "NRP-Z Power Analysis"](#), on page 151.

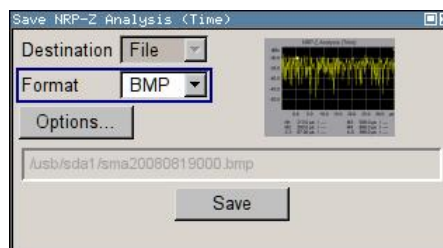
**Destination - Power Analysis**

Indicates that the hardcopy is stored in a file.

SCPI command:

[SENSe\[:POWER\]:SWEep:HCOPY:DEVIce](#) on page 414

Format - Power Analysis

Selects the file format.

Several bitmap graphic format are offered. In addition, format * .csv is available which stores the measurement values as ASCII data. The csv settings are performed in the "Options..." submenu.

SCPI command:

[SENSe\[:POWER\]:SWEep:HCOPY:DEVIce:LANGUage](#) on page 415

File name - Power Analysis

Indicates the file name.

The file name can be entered either manually via the file manager (button "File...") or generated automatically. Automatic naming is activated and configured in the "Options..." subdialog

SCPI command:

[SENSe\[:POWER\]:SWEep:HCOPY:FILE\[:NAME\]](#) on page 417

[SENSe\[:POWER\]:SWEep:HCOPY:FILE\[:NAME\]:AUTO:STATE](#) on page 421

[SENSe\[:POWER\]:SWEep:HCOPY:FILE\[:NAME\]:AUTO:FILE?](#) on page 418

Save Hardcopy - Power Analysis

Stores the current measurement diagram as hardcopy in a graphic file format or the trace data in a csv-file, depending on the selected file format.

SCPI command:

[SENSe\[:POWer\]:SWEep:HCOPY\[:EXECute\]](#) on page 417

Save Options - Power Analysis

Opens a submenu to enter the screenshot format and size and also to activate and select the automatic naming settings.

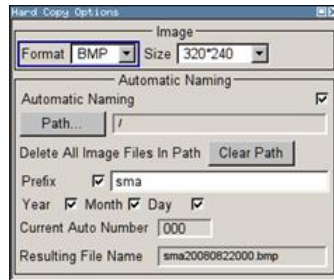

"Format" Selects the hardcopy format. In addition to several bitmap formats, format "*.csv" is available which stores the measurement values as ASCII data.

SCPI command:

[SENSe\[:POWer\]:SWEep:HCOPY:DEVIce:LANGUage](#) on page 415

"Size" Defines the size of the bitmap in terms of pixels. The first value of the size setting defines the width, the second value the height of the image.

SCPI command:

[SENSe\[:POWer\]:SWEep:HCOPY:DEVIce:SIZE](#) on page 416

"Automatic Naming" Selects that file names are created by rules if checked. The filename includes at least number and optionally additional information which is determined below.

SCPI command:

[SENSe\[:POWer\]:SWEep:HCOPY:FILE\[:NAME\]:AUTO:STATe](#) on page 421

"Path" Sets the directory the files are saved into. The "Clear Path" button deletes all image files with extensions "bmp", "img", "png", "xpm" and "csv" in the directory set for automatic naming.

SCPI command:

[SENSe\[:POWer\]:SWEep:HCOPY:FILE\[:NAME\]:AUTO:DIRectory](#) on page 418

[SENSe\[:POWer\]:SWEep:HCOPY:FILE\[:NAME\]:AUTO:DIRectory:CLEar](#)
on page 418

"Prefix, Year, Month, Day" "Prefix, Year, Month, Day" are included in the file name if checked and automatic naming is selected. The Auto Number used for file name creation and the resulting file name are indicated below.

SCPI command:

`SENSe[:POWer]:SWEep:HCOPY:FILE[:NAME]:AUTO[:FILE]:PREFIX:STATe`
on page 420

`SENSe[:POWer]:SWEep:HCOPY:FILE[:NAME]:AUTO[:FILE]:PREFIX`
on page 420

`SENSe[:POWer]:SWEep:HCOPY:FILE[:NAME]:AUTO[:FILE]:DAY:STATe`
on page 419

`SENSe[:POWer]:SWEep:HCOPY:FILE[:NAME]:AUTO[:FILE]:DAY?` on page 419

`SENSe[:POWer]:SWEep:HCOPY:FILE[:NAME]:AUTO[:FILE]:MONTH:STATe`
on page 420

`SENSe[:POWer]:SWEep:HCOPY:FILE[:NAME]:AUTO[:FILE]:MONTH?`
on page 419

`SENSe[:POWer]:SWEep:HCOPY:FILE[:NAME]:AUTO[:FILE]:YEAR:STATe`
on page 421

`SENSe[:POWer]:SWEep:HCOPY:FILE[:NAME]:AUTO[:FILE]:YEAR?`
on page 421

"Current Auto Number" Automatic naming only
Indicates the number which is used in the automatically generated file name.

SCPI command:

`SENSe[:POWer]:SWEep:HCOPY:FILE[:NAME]:AUTO[:FILE]:NUMBER?`
on page 420

"Resulting File Name" Automatic naming only
Indicates the automatically generated file name.

SCPI command:

`SENSe[:POWer]:SWEep:HCOPY:FILE[:NAME]:AUTO:FILE?` on page 418

SCPI command:

`SENSe[:POWer]:SWEep:HCOPY[:EXECute]` on page 417

CSV Options Hardcopy- Power Analysis

If file format *.csv is selected, the trace data is saved as an ASCII file with separated values. Additional settings are available in the hardcopy options submenu.

CSV files can be imported into the program MS Excel and then processed further. Adjust the value separator and the decimal point according to the language version, to import the data correctly.

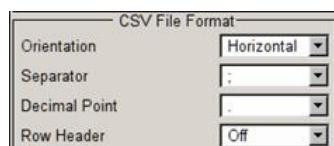

"Orientation" Defines the orientation of the X/Y value pairs:

- **Horizontal:**
X/Y values of trace 1 in rows 1 and 2,
X/Y values of trace 2 in rows 3 and 4,
X/Y values of trace 3 in rows 5 and 6,
X/Y values of trace 4 in rows 7 and 8.

Example:

Trace1,X[Hz]: 10000.0; 10010.0; 10020.0; 10030.0; ...

Trace1,Y[dBm]: -20.09; -19.17; -18.19; -15.43; ...

Trace2,X[Hz]: 10000.0; 10010.0; 10020.0; 10030.0; ...

Trace2,Y[dBm]: -19.09; -18.17; -17.19; -14.43; ...

Trace3,X[Hz]: 10000.0; 10010.0; 10020.0; 10030.0; ...

Trace3,Y[dBm]: -21.09; -20.17; -19.19; -16.43; ...

Trace4,X[Hz]: 10000.0; 10010.0; 10020.0; 10030.0; ...

Trace4,Y[dBm]: -22.07; -20.14; -21.56; -17.67; ...

- **Vertical:**

X/Y values of trace 1 in column 1 and 2,
X/Y values of trace 2 in column 3 and 4,
X/Y values of trace 3 in column 5 and 6,
X/Y values of trace 4 in column 7 and 8.

Example:

Trace1,X[Hz]; Trace1,Y[dBm]; Trace2,X[Hz]; Trace2,Y[dBm];

Trace3,X[Hz]; Trace3,Y[dBm]; Trace4,X[Hz]; Trace4,Y[dBm];

10000.0;-20.09;10000.0; -19.09;10000.0;21.09;10000.0;22.07;

10010.0;-19.17;10010.0;-18.17;10010.0; -20.17;10010.0; -20.14;

10020.0;-18.19;10020.0;-17.19;10020.0;-19.19;10020.0;-21.56;

10030.0; -15.43;10030.0; -14.43;10030.0;-16.43;10030.0;-17,67;...

SCPI command:

[SENSe\[:POWER\]:SWEep:HCOPY:DEVice:LANGUage:CSV:ORientation](#)
on page 416

"Separator" Defines which character should be used to separate the values, either tabulator, semicolon, comma or blank.

SCPI command:

[SENSe\[:POWER\]:SWEep:HCOPY:DEVice:LANGUage:CSV\[:COLumn\]:SEParator](#)
on page 416

"Decimal Point" Defines which character should be used as the decimal point of the values, either dot or comma.

SCPI command:

[SENSe\[:POWER\]:SWEep:HCOPY:DEVice:LANGUage:CSV:DPOint](#) on page 415

"Row Header" Defines whether each row (or column depending on the orientation) should be preceded by a header containing information about the trace, i.e. the index of the trace and the type of value (frequency or power or time).

Example:

Trace=2;Source=detecting..;X[Hz];"Trace=2;Source=detecting..;Y[dBm]"

SCPI command:

[SENSe\[:POWer\]:SWEep:HCOPy:DEVice:LANGUage:CSV:HEADer](#) on page 415

5.3.7 RF Sweep and List Mode

5.3.7.1 Overview

The R&S Signal Generator offers three different sweep types (frequency sweep, level sweep and LF sweep) to be activated alternatively. Each type has 6 modes which differ with respect to the sweep cycle mode (continuous, individual and step-by-step) and triggering mode (automatic, internal and external).



Sweeps and List mode can not be activated simultaneously, they deactivate each other.

A phase continuous frequency sweep can be generated after activating the phase continuous mode, see "[Setting a Phase Continuous Frequency Sweep](#)" on page 121.

Setting a sweep

A sweep is set in five basic steps which are shown below taking a frequency sweep as an example.



The LF sweep is activated and configured in the "Mod Gen" block.

1. Set the sweep range ("Start Freq" and "Stop Freq" or "Center Freq" and "Span").
2. Select linear or logarithmic sweep spacing ("Spacing").
3. Set the step width ("Step Lin/Log") and dwell time ("Dwell Time").
4. Activate the sweep ("Mode" to Auto, Single, Step or Extern Single, Extern Step).
5. Trigger the sweep, except for Auto mode ("Execute Single Sweep", Current Frequency or External Trigger Signal).



It is recommended to switch off the GUI update for optimum sweep performance especially with short dwell times (see [chapter 5.2.3.5, "Gui Update"](#), on page 88).

5.3.7.2 RF Frequency Sweep

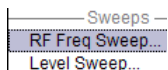

The dialog is used to activate and configure a sweep for the RF frequency.

To open the "Frequency Sweep" menu, select "RF > Configure > RF Frequency Sweep" or use the menu tree of the MENU key under "RF".

In the top section of the menu, the RF sweep mode is activated and the sweep mode is selected.

The buttons are used to reset the RF sweep (all sweep modes) or to execute the RF sweep ("Single" mode).

The sweep range, sweep spacing and dwell time are set in the bottom section.

The sweep range of the RF sweep can be entered in two ways, either by entering the "Start" and "Stop" value or by entering the "Center" and "Span".

The two sets of parameters influence each other in the following way:

- "Start Freq" = "Center Freq" - "Span"/2
- "Stop Freq" = "Center Freq" + "Span"/2
- "Center Freq" = ("Start Freq" + STOP FREQ)/2
- "Span" = "Stop Freq" - "Start Freq"

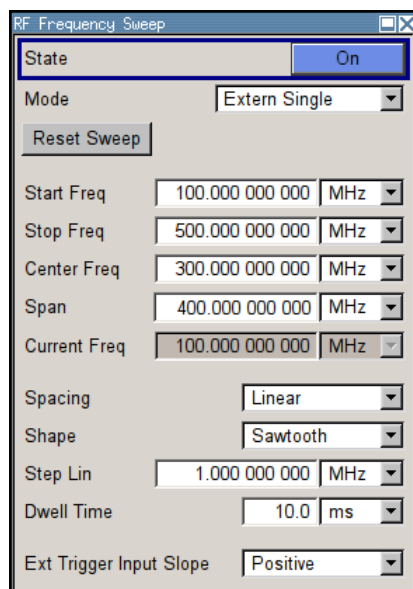

RF Frequency Sweep Settings

State - Frequency Sweep

Activates/deactivates RF sweep mode.

Note: Activating the RF-Sweep mode automatically disables other sweep modes, and the list mode.

SCPI command:

[:SOURce<hw>] :FREQuency:MODE on page 503

Mode - Frequency Sweep

Selects the sweep instrument operating mode and the sweep mode.

"Auto" Sets an automatic repeated sweep cycle. If a different sweep mode was activated prior to the "Auto" mode, the cycle continues from the current sweep setting.
The "Reset Sweep" button resets the sweep to the start frequency.

Example:

```
SOUR:SWE:FREQ:MODE AUTO
TRIG:FSW:SOUR AUTO
SOUR:FREQ:MODE SWE
```

"Single" Sets a single sweep cycle. The sweep is triggered by the "Execute Single Sweep" button.
If a different sweep mode was activated prior to the "Single" mode, the current sweep is stopped. The "Single" sweep always starts at the start frequency when triggered.
The "Reset Sweep" button resets the sweep to the start frequency.

Example:

```
SOUR:SWE:FREQ:MODE AUTO
TRIG:FSW:SOUR SING
SOUR:FREQ:MODE SWE
SOUR:SWE:FREQ:EXEC
```

"Step" Sets a step-by-step sweep cycle. When mode "Step" is activated, the frequency is set to the sweep "Start Freq". To step through the sweep frequencies manually, open the "Current Freq" field for input and use the UP / DOWN navigation keys or the rotary knob. You can determine the step width below in the entry field "Step Lin" or "Step Log", see [Step Lin/Log - Frequency Sweep](#). If a sweep range border frequency ("Start Freq" or "Stop Freq") is reached, step commands in direction out of the sweep range are ignored. The "Reset Sweep" button resets the sweep to the start frequency.

Note: To step through the sweep frequencies in remote control mode, use the `FREQ:MAN` command with the `UP` or `DOWN` parameter.

Example:

```
SOUR:FREQ:CENT 300MHz
```

```
SOUR:FREQ:SPAN 400MHz
```

```
SOUR:SWE:FREQ:SPAC LIN
```

```
SOUR:SWE:FREQ:STEP:LIN 100MHz
```

```
SOUR:FREQ:MODE MAN
```

set sweep mode "Step".

```
SOUR:FREQ:MODE SW
```

activate sweep mode, the frequency is set to "Start Freq".

```
SOUR:FREQ:MAN UP
```

set the frequency to the next higher sweep frequency.

```
SOUR:FREQ:MAN DOWN
```

set the frequency to the next lower sweep frequency.

"Extern Single" Sets a single sweep cycle. The sweep is triggered by an external trigger signal. If a different sweep mode was activated prior to the "Extern Single" mode, the current sweep is stopped. The "Extern Single" sweep always starts at the start frequency when triggered. Refer to the description of the rear panel for information about the connectors for external trigger signal input (see [chapter 2.2, "Rear Panel Tour"](#), on page 21). The "Reset Sweep" button resets the sweep to the start frequency.

Example:

```
SOUR:SWE:FREQ:MODE AUTO
```

```
TRIG:FSW:SOUR EXT
```

```
SOUR:FREQ:MODE SWE (External trigger)
```

"Extern Step" Sets a step-by-step sweep cycle. Each sweep step is triggered by an external trigger signal (trigger source as described under "Extern Single"). The step width is set below at entry field "Step Lin" or "Step Log".
If a different sweep mode was activated prior to the "Extern Step" mode, the current sweep is stopped. The "Extern Step" sweep always starts at the start frequency when triggered.
The "Reset Sweep" button resets the sweep to the start frequency.

Example:

```
SOUR:SWE:FREQ:MODE STEP
SOUR:SWE:FREQ:SPAC LIN
SOUR:SWE:FREQ:STEP:LIN 1MHz
TRIG:FSW:SOUR EXT
SOUR:FREQ:MODE SWE (External trigger)
```

"Extern Start/Stop" Sets an automatically repeated sweep cycle that is started, stopped and restarted by subsequent external trigger events.
The first external trigger signal starts the sweep (Start).
The next external trigger signal stops the sweep at the current frequency (Stop).
The third external trigger signal starts the sweep at the start frequency (Start).
If a different sweep mode was activated prior to the "Extern Start/Stop" mode, the current sweep is stopped and the "Extern Start/Stop" sweep starts at the start frequency when triggered.
The "Reset" button resets the sweep to the start frequency.
Refer to the description of the rear panel for information about the connectors for external trigger signal input.
The external trigger signal is input at the rear of the instrument (BNC connector INST TRIG).

Example:

```
SOUR:SWE:FREQ:MODE AUTO
TRIG:FSW:SOUR EAUT
SOUR:FREQ:MODE SWE (External trigger)
```

SCPI command:

[\[:SOURce<hw>\]:SWEep\[:FREQuency\]:MODE](#) on page 597
[:TRIGger<hw>:FSWEEP:SOURce](#) on page 635
[\[:SOURce<hw>\]:FREQuency:MODE](#) on page 503

Execute Single Sweep - Frequency Sweep

Triggers the sweep manually. A manual sweep can only be triggered if "Mode Single" is selected.

SCPI command:

[\[:SOURce<hw>\]:SWEep\[:FREQuency\]:EXECute](#) on page 596

Reset Sweep - Frequency Sweep

Resets the sweep. The start frequency is set and the next sweep starts from there.

SCPI command:

[\[:SOURce<hw>\]:SWEep:RESet\[:ALL\]](#) on page 604

Start Freq - Frequency Sweep

Sets the start frequency.

SCPI command:

[\[:SOURce<hw>\]:FREQuency:STARt](#) on page 507

Stop Freq - Frequency Sweep

Sets the stop frequency.

SCPI command:

[\[:SOURce<hw>\]:FREQuency:STOP](#) on page 508

Center Freq - Frequency Sweep

Sets the center frequency.

SCPI command:

[\[:SOURce<hw>\]:FREQuency:CENTer](#) on page 501

Span - Frequency Sweep

Sets the span.

SCPI command:

[\[:SOURce<hw>\]:FREQuency:SPAN](#) on page 506

Current Freq - Frequency Sweep

Displays the current frequency.

If "Step" is set, the frequency for the next frequency step of the sweep is entered here.

SCPI command:

[\[:SOURce<hw>\]:FREQuency:MANual](#) on page 502

Spacing - Frequency Sweep

Selects linear or logarithmic sweep spacing.

- | | |
|---------------|--|
| "Linear" | With the linear sweep, the step width is a fixed frequency value which is added to the current frequency. The step width is entered below. |
| "Logarithmic" | With the logarithmic sweep, the step width is a constant fraction of the current frequency. This fraction is added to the current frequency. The logarithmic step width is entered below in %. |

SCPI command:

[\[:SOURce<hw>\]:SWEep\[:FREQuency\]:SPACing](#) on page 598

Shape - RF Frequency Sweep

Selects the cycle mode for a sweep sequence (shape).

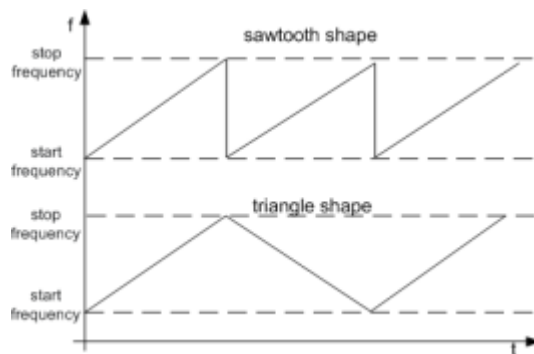

"Sawtooth" One sweep runs from start to stop frequency. Each subsequent sweep starts at the start frequency, i.e. the shape of the sweep sequence resembles a sawtooth.

"Triangle" One sweep runs from start to stop frequency and back, i.e. the shape of the sweep resembles a triangle. Each subsequent sweep starts at the start frequency.

SCPI command:

[\[:SOURCE<hw>\]:SWEep\[:FREQUENCY\]:SHAPE](#) on page 598

Step Lin/Log - Frequency Sweep

Sets the step width for the individual sweep steps. This entry is effective for all sweep modes.

"Step Lin" or "Step Log" is displayed depending on whether "Spacing Lin" or "Log" is selected.

"Step Lin" With the linear sweep, the step width is a fixed frequency value which is added to the current frequency. The linear step width is entered in Hz.

SCPI command:

[\[:SOURCE<hw>\]:SWEep\[:FREQUENCY\]:STEP\[:LINear\]](#) on page 599

"Step Log" With the logarithmic sweep, the step width is a constant fraction of the current frequency. The logarithmic step width is entered in %. Successive frequencies are calculated as follows:

- **start_f < stop_f**
 $f_2 = f_1 * (1 + \text{step_log} / 100)$
 If $f_2 > \text{stop_f}$: f_2 is set to stop_f .
- **start_f > stop_f**
 $f_2 = f_1 / (1 + \text{step_log} / 100)$
 If $f_2 < \text{stop_f}$: f_2 is set to stop_f .

When the shape "Triangle" is set, the frequency values on the slope from **stop_f back to start_f** are the same as on the slope from **start_f to stop_f**.

SCPI command:

[\[:SOURCE<hw>\]:SWEep\[:FREQUENCY\]:STEP:LOGarithmic](#) on page 600

Dwell Time - Frequency Sweep

Sets the dwell time. The dwell time determines the duration of the individual sweep steps.

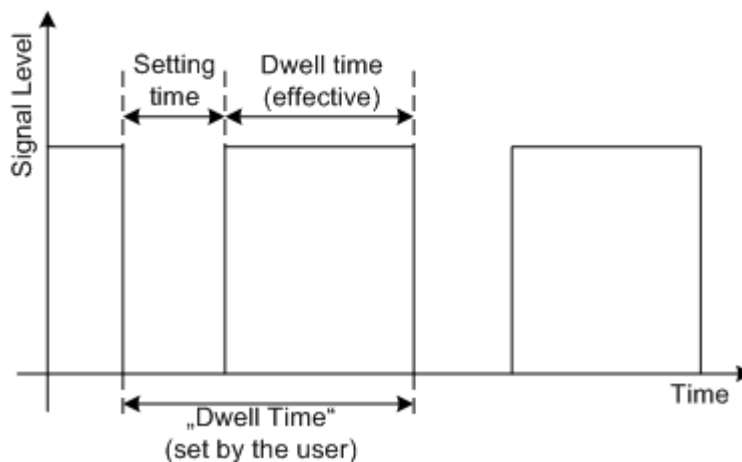

The "Dwell Time" set by the user is used as the step time of the sweep. The effective net dwell time is shorter, reduced by the setting time. This setting time may be greater than the time specified in the data sheet.

Note:

It is recommended to switch off the GUI update for optimum sweep performance especially with short dwell times (see [chapter 5.2.3.5, "Gui Update"](#), on page 88).

SCPI command:

`[:SOURce<hw>] :SWEep [:FREQuency] :DWELl` on page 596

Trigger Input Slope

Sets the polarity of the active slope of an applied instrument trigger.

This setting affects the INST TRIG input (BNC connector at the rear of the instrument).

"Positive" The rising edge of the trigger signal is active.

"Negative" The falling edge of the trigger signal is active.

SCPI command:

`[:SOURce] :INPut :TRIGger :SLOPe` on page 525

5.3.7.3 RF Level Sweep

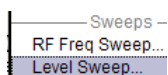

To open the "Level Sweep" menu, select "RF > Configure > Level Sweep" or use the MENU key under "RF".

RF Level Sweep Settings

The "RF Level Sweep" dialog is used to activate and configure a sweep for the RF level.

In the top section, the Level Sweep is activated and the sweep mode is selected. The buttons are used to reset the level sweep (all sweep modes) or to execute the level sweep ("Single" mode).

The sweep range, sweep spacing and dwell time are set in the bottom section.

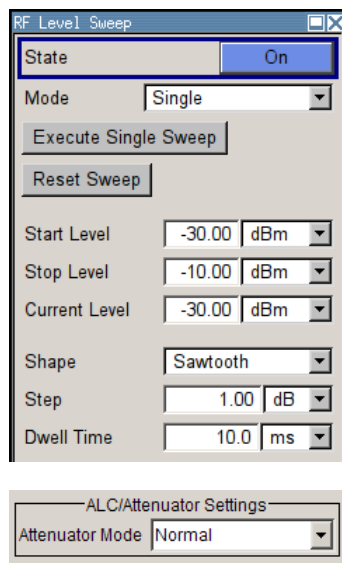

State - Level Sweep

Activates Level Sweep mode.

Note: Activating the RF level sweep mode automatically disables other sweep modes, and the list mode.

SCPI command:

[\[:SOURce<hw>\]:POWer:MODE](#) on page 571

Mode - Level Sweep

Selects the level sweep instrument operating mode and the sweep mode.

"Auto" Sets an automatically repeated sweep cycle. If a different sweep mode was activated prior to the "Auto" mode, the cycle continues from the current sweep setting.

The "Reset Sweep" button resets the sweep to the start level.

Example:

```
SOUR:SWE:POW:MODE AUTO
TRIG:PSW:SOUR AUTO
SOUR:POW:MODE SWE
```

"Single" Sets a single sweep cycle. The sweep is triggered by the "Execute Single Sweep" button.
 If a different sweep mode was activated prior to the "Single" mode, the current sweep is stopped. The single sweep always starts at the start level.
 The "Reset Sweep" button resets the sweep to the start level.

Example:

```
SOUR:SWE:POW:MODE AUTO
TRIG:PSW:SOUR SING
SOUR:POW:MODE SWE
SOUR:SWE:POW:EXEC
```

"Step" Sets a step-by-step sweep cycle.
 If this mode is activated, the cursor moves to the value displayed for "Current Level". Each sweep step is triggered by a variation of the value in the "Current Level" entry window. The step width is set below at entry field "Step".
 If this mode is activated, the cursor moves to the value displayed for "Current Level". If a different sweep mode was activated prior to the "Step" mode, the current sweep is stopped. The step sweep starts at the current level value.
 The "Reset Sweep" button resets the sweep to the start level.

Example:

```
SOUR:SWE:POW:MODE MAN
SOUR:SWE:POW:STEP 0.5
SOUR:POW:MODE SWE
SOUR:POW:MAN -16
```

The value entered with command `SOUR:SWE:POW:STEP` sets the step width.

The value entered with command `SOUR:POW:MAN` has no effect, the command only triggers the next sweep step. However, the value has to be in the currently set sweep range (start to stop). In remote control only a step-by-step sweep from start to stop frequency is possible.

- "Extern Single" Sets a single sweep cycle. The sweep is triggered by an external trigger signal.
If a different sweep mode was activated prior to the "Extern Single" mode, the current sweep is stopped. The "Extern Single" sweep always starts at the start level.
Refer to the description of the rear panel for information about the connectors for external trigger signal input (see [chapter 2.2, "Rear Panel Tour"](#), on page 21).
The "Reset Sweep" button resets the sweep to the start level.

Example:

```
SOUR:SWE:POW:MODE AUTO
TRIG:PSW:SOUR EXT
SOUR:POW:MODE SWE (External trigger)
```

- "Extern Step" Sets a step-by-step sweep cycle. Each sweep step is triggered by an external trigger signal (trigger source as described under "Extern Single"). The step width corresponds to the step width of the rotary knob. If a different sweep mode was activated prior to the "Extern Step" mode, the current sweep is stopped. The "Extern Step" sweep always starts at the start level.
The "Reset Sweep" button resets the sweep to the start level.

Example:

```
SOUR:SWE:POW:MODE STEP
SOUR:SWE:POW:STEP 0.5
TRIG:PSW:SOUR EXT
SOUR:POW:MODE SWE (External trigger)
```

"Extern Start/ Stop" Sets an automatically repeated sweep cycle that is started, stopped and restarted by subsequent external trigger events. The first external trigger signal starts the sweep (Start). The next external trigger signal stops the sweep at the current frequency (Stop). The third external trigger signal starts the sweep at the start frequency (Start). If a different sweep mode was activated prior to the "Extern Start/ Stop" mode, the current sweep is stopped and the "Extern Start/Stop" sweep starts at the start frequency when triggered. The "Reset" button resets the sweep to the start level. Refer to the description of the rear panel for information about the connectors for external trigger signal input (see [chapter 2.2, "Rear Panel Tour"](#), on page 21).

Example:

```
SOUR:SWE:POW:MODE AUTO
TRIG:PSW:SOUR EAUT
SOUR:POW:MODE SWE (External trigger)
```

SCPI command:

[\[:SOURce<hw>\]:SWEep:POWer:MODE](#) on page 601
[:TRIGger<hw>:PSWeep:SOURce](#) on page 637.
[\[:SOURce<hw>\]:POWer:MODE](#) on page 571

Reset Sweep - Level Sweep

Resets the sweep. The start level is set and the next sweep starts from there.

SCPI command:

[\[:SOURce<hw>\]:SWEep:RESet \[:ALL\]](#) on page 604

Execute Single Sweep - Level Sweep

Triggers the sweep manually. A manual sweep can only be triggered if "Mode Single" is selected.

Example:

```
SOUR:SWE:POW:MODE AUTO
TRIG:PSW:SOUR SING
SOUR:POW:MODE SWE
SOUR:SWE:EXEC
```

SCPI command:

[\[:SOURce<hw>\]:SWEep:POWer:EXECute](#) on page 601

Start Level - Level Sweep

Sets the start level.

SCPI command:

[\[:SOURce<hw>\]:POWer:START](#) on page 574

Stop Level - Level Sweep

Sets the stop level.

SCPI command:

[\[:SOURce<hw>\]:POWer:STOP](#) on page 576

Current Level - Level Sweep

Displays the current level.

If "Step" is set, the level for the next level step of the sweep is entered here.

SCPI command:

[\[:SOURce<hw>\]:POWer:MANual](#) on page 570

Shape - RF Level Sweep

Selects the cycle mode for a sweep sequence (shape).

"Sawtooth" One sweep runs from the start level to the stop level. The subsequent sweep starts at the start level again, i.e. the shape of sweep sequence resembles a sawtooth.

"Triangle" One sweep runs from start to stop level and back, i.e. the shape of the sweep resembles a triangle. Each subsequent sweep starts at the start level again.

SCPI command:

[\[:SOURce<hw>\]:SWEep:POWer:SHAPE](#) on page 602

Step - Level Sweep

Sets the step width for the individual sweep steps. This entry is effective for all sweep modes.

With the level sweep, the logarithmic step width is a constant fraction of the current level. This fraction is added to the current level. The logarithmic step width is entered in dB.

SCPI command:

[\[:SOURce<hw>\]:SWEep:POWer:STEP\[:LOGarithmic\]](#) on page 603

Dwell Time - Level Sweep

Enters the dwell time and determines the duration of the individual sweep steps.

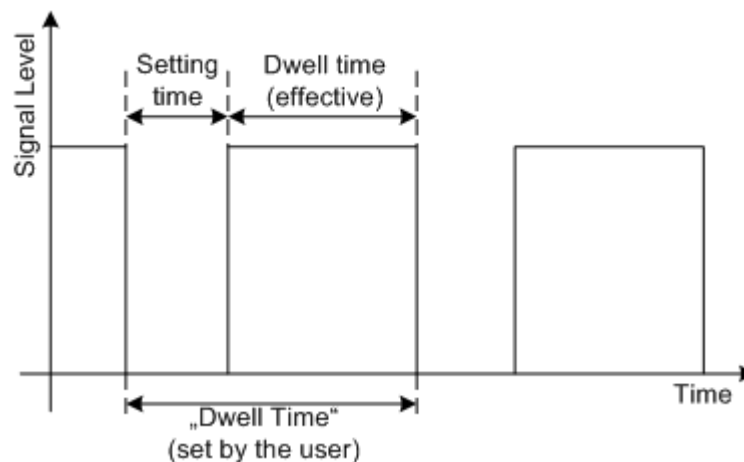

The "Dwell Time" set by the user is used as the step time of the sweep. The effective net dwell time is shorter, reduced by the setting time. This setting time may be greater than the time specified in the data sheet.

Note:

It is recommended to switch off the GUI update for optimum sweep performance especially with short dwell times (see [chapter 5.2.3.5, "Gui Update"](#), on page 88).

SCPI command:

[\[:SOURce<hw>\]:SWEep:POWer:DWELl](#) on page 601

Trigger Input Slope

Sets the polarity of the active slope of an applied instrument trigger.

This setting affects the INST TRIG input (BNC connector at the rear of the instrument).

"Positive" The rising edge of the trigger signal is active.

"Negative" The falling edge of the trigger signal is active.

SCPI command:

[\[:SOURce\]:INPut:TRIGger:SLOPe](#) on page 525

Attenuator Mode - Level Sweep with High Power Option

(High Power Option only)

Sets the ranges of level settings for the level sweep. The sweep is either performed in the low level (electronically switching attenuator) or in the high level (relay-switched high-power-bypass) ranges.

Note: An error message is generated and the best possible level is set if the level setting for the current sweep step is outside the selected range.

"Normal " The level settings for the level sweep are made in the area of the electronically switching attenuator. The high level ranges are not available.

"High Power " The level settings for the level sweep are made in the area of the option. Only the high level range is available.

SCPI command:

[\[:SOURce<hw>\]:SWEep:POWer:AMODE](#) on page 600

5.3.7.4 List Mode

Similar to a sweep, a series of previously defined frequency and level points is processed in List mode. In contrast to a sweep, however, a list with freely selectable value pairs (frequency and level) can be created. The value range for frequency and level covers the entire configurable value range of the instrument.



List mode and sweeps can not be activated simultaneously, they deactivate each other.

The lists can be created in the "List Editor". Each list is stored in its own file with the predefined file extension *.lsw. The name of the list file can be freely selected. The files are loaded from the "Lists..." file manager. Externally created tables with pairs of fre-

quency and level values can be converted into List files using the import function. The external files must have the file extension *.txt or *.csv. These file formats are provided e.g. by the Microsoft®Excel program. The separators for table columns and for decimal floating-point numerals can be set. In addition, internally created List data can be exported into ASCII files using the export function.

The necessary hardware settings are calculated the first time a list is processed. With long dwell times, this calculation can be performed while the list is being processed; the entered dwell times are observed. With very short dwell times, calculation of the hardware settings increases the dwell time for the initial processing cycle; the entered value is only observed from the second processing cycle onwards. In this case a message appears to inform the user that there is a deviation between the current and set dwell times. No further calculations are required after the first run through a list. The current dwell times will definitely no longer deviate from the set dwell times.

The list is either processed from the beginning to the end of the list (modes "Auto", ("External") "Single", ("External") "Step") or by hopping from one freely selectable list index (frequency/level pair) to the next (modes "Extern Hop", "Extern Hop Direct").

List Mode Extern Hop

The Extern Hop control signals (clock, strobe and data) are supplied via the serial FHOP bus on the "AUX I/O" interface at the rear of the instrument.

Data transmission starts with the MSB (most significant bit). A strobe marks the LSB (least significant bit) and thus the end of a valid data sequence (40 bits). The data bits determine the RF path, the Extern Hop mode (direct or not) and the processed list index. The timing of the control signals is illustrated in the following figure.

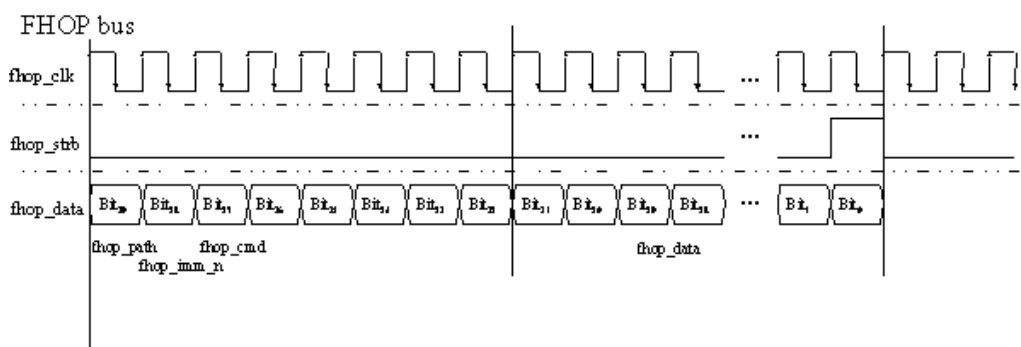

Fig. 5-7: Input control signals for List Modes Fast Hop and Fast Hop Direct on the serial FHOP bus

Table 5-1: Function of data bits of FHOP bus (fhop_data line) and their function for controlling fast frequency hopping

Data bit name (bit number)	Function
path (39)	Bit 39 must be set to 0
imm_n (38)	Selects Fast Hop mode: <ul style="list-style-type: none"> 0 = Fast Hop Direct the selected settings are performed at once after data transfer of a complete sequence (40 bits) without additional triggering 1 = Fast Hop the selected settings are performed after an instrument trigger
cmd (37 to 32)	Selects function for fast hop mode. Bit 32 must be set to 1 (= List Mode) Bit 37 to 33 must be set to 0 (= reserved for future extensions)
data (31 to 0)	Data bits Determine the list index (frequency/level setting) to be processed for List Mode

Example:

The bit sequence 0100-0010-0000-0000-0000-0000-0000-0000-1010 on data line "fhop_data" selects the list index 10 of the currently loaded list on Path A. The frequency and level setting associated with this index are performed after the next instrument trigger.

Preconditions:

List Mode "Extern Hop" is selected in the "List" menu and a list with at least 10 entries is loaded.

An external trigger is provided at the INST TRIG connector.

List Mode Dialog

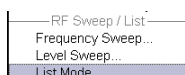

To open the "List Mode" menu, select "RF > Configure > List Mode" or use the MENU key under "RF".

The menu is used to activate/deactivate the operating mode List, to create, select and activate the lists, and to select the trigger mode and the dwell time.

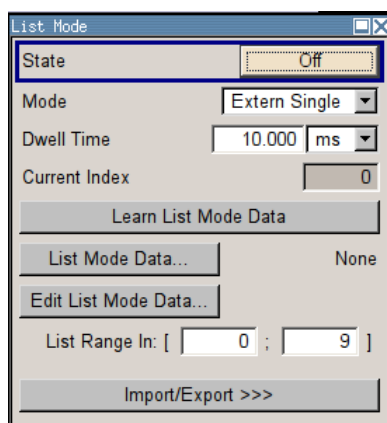

General Settings

State - List Mode

Activates/deactivates the List mode. The currently selected list is processed.

In case of a new or modified list, the necessary hardware settings are automatically determined on activation of the list mode. The data determined in this way is stored along with the list and is available whenever the list is used again.

This means that when activating the list mode, the system checks whether any hardware settings are present. If so, the list is started immediately, but if not they are automatically determined (the list is learnt).

A "Learn List Mode Data" button is available for deliberately activating list learning.

Note: Activating the list mode automatically deactivates all sweeps. During list mode the frequency and level indications do not display the currently set values.

SCPI command:

[\[:SOURce<hw>\]:FREQuency:MODE](#) on page 503

Attenuator Mode – List Mode with High Power Option

(High Power Option only)

Sets the ranges of level settings for the level sweep. The sweep is either performed in the low level (electronically switching attenuator) or in the high level (relay-switched high-power-bypass) ranges.

Note: An error message is generated and the best possible level is set if the level setting for the current sweep step is outside the selected range.

- | | |
|---------------|--|
| "Normal " | The level settings for the level sweep are made in the area of the electronically switching attenuator. The high level ranges are not available. |
| "High Power " | The level settings for the level sweep are made in the area of the option. Only the high level range is available. |

SCPI command:

[\[:SOURce<hw>\]:LIST:POWer:AMODE](#) on page 548

Mode - List Mode

Selects the cycle mode of the List mode.

"Auto" Cycle from the beginning to the end of the list with automatic restart at the beginning. If a different mode was activated prior to the Auto mode, the cycle continues from the beginning of the list. The duration of a list step is determined by the set dwell time.
Button "Reset" restarts the list at the starting point.

"Single" Single cycle from the beginning to the end of the list. If "Single" is selected, the cycle is not started immediately. The "Execute Single" button appears under the "Mode" line. The cycle is started with this button. The duration of a list step is determined by the set dwell time.
Button "Reset" restarts the list at the starting point.



"Step" Manual, step-by-step processing of the list. Activating "Step" stops the current list and the cursor moves to the value displayed for "Current Index". It is now possible to scroll up and down in the list in discrete steps by varying the index. The duration of a list step is determined by the time between two index entries.
Button "Reset" restarts the list at the starting point.



"Extern Single" Single cycle from the beginning to the end of the list as with "Single", but started by an external trigger.
The external trigger signal is input at the BNC connector INST TRIG.
Button "Reset" restarts the list at the starting point.

"Extern Step" Step-by-step cycle using the external trigger signal. Each trigger event starts a single step. The duration of a list step is determined by the time between two trigger events.
The external trigger signal is input at the BNC connector INST TRIG.
Button "Reset" restarts the list at the starting point.

"Extern Hop" Index-by-index cycle.
The processed list index is determined by the external control signals provided via the serial FHOP bus on the AUX I/O interface at the rear of the instrument (see "[List Mode Extern Hop](#)" on page 203).
The external trigger signal is used. Each trigger event starts the processing of the frequency and level settings associated with selected index (trigger source as described under "Extern Single"). The duration of a list step is determined by the time between two trigger events. Note that the fhop_imm_n bit has to be disabled on the fhop_data line (=1).

"Extern Hop Direct" Index-by-index cycle. The processed list index is determined by the external control signals provided via the serial FHOP bus.
Processing of the frequency and level settings associated with selected index is automatically started at the end of data transmission. Note that the fhop_imm_n bit has to be enabled on the fhop_data line (= 0).

SCPI command:

[:SOURce<hw>] :LIST:MODE on page 547

[:SOURce<hw>] :LIST:TRIGger:SOURce on page 550

Execute Single - List Mode

Triggers the list manually. This button is available only if mode "Single" is selected.

SCPI command:

[\[:SOURce<hw>\]:LIST:TRIGger:EXECute](#) on page 549

Reset - List Mode

Resets the list to the starting point.

SCPI command:

[\[:SOURce<hw>\]:LIST:RESet](#) on page 549

Dwell Time - List Mode

Enters the dwell time. The dwell time determines the duration of a list step in list operating modes "Auto", "Single" and "Extern Single". In these modes a complete list is processed either once or continuously.

In list operating modes "Step" and "Extern Step", the set dwell time does not affect signal generation. In this case, the duration of a list step is determined by the time between two (internal or external) trigger events.

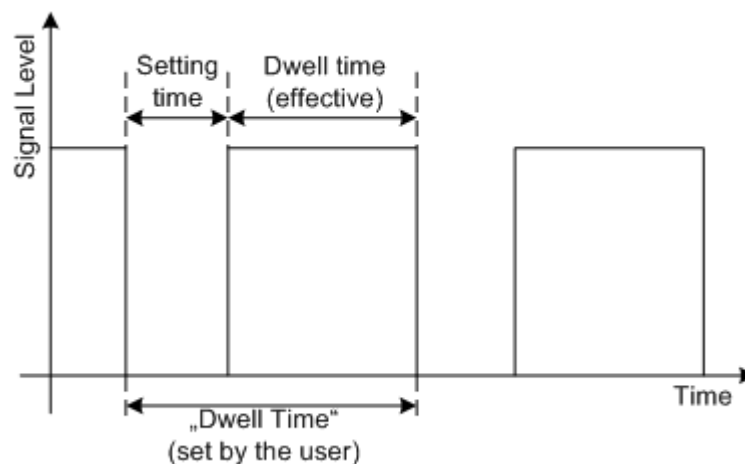

The "Dwell Time" set by the user is used as the step time of the list mode. The effective net dwell time is shorter, reduced by the setting time. This setting time may be greater than the time specified in the data sheet.

SCPI command:

[\[:SOURce<hw>\]:LIST:DWELL](#) on page 544

Current Index - List Mode

Sets the list index in "Step" mode.

SCPI command:

[\[:SOURce<hw>\]:LIST:INDEX](#) on page 545

Learn List Mode Data... - List Mode

Starts the determination of the hardware setting for the selected list. The data determined in this way is stored along with the list.

It may be necessary to deliberately activate list learning in the event of greatly altered environmental conditions that require new hardware settings.

If this is not done, a previously learned hardware setting will continue to be used when list mode is switched on ("State = On"). If no setting is available, e.g. when the list is used for the first time, learning is automatically activated.

SCPI command:

[\[:SOURce<hw>\]:LIST:LEARn](#) on page 547

List Mode Data... - List Mode

Calls the "File Select" menu for selecting and creating a list or the "File Manager".



SCPI command:

[\[:SOURce<hw>\]:LIST:SElect](#) on page 549

[\[:SOURce<hw>\]:LIST:DElete](#) on page 539

[\[:SOURce<hw>\]:LIST:DElete:ALL](#) on page 539

Edit List Mode Data... - List Mode

Calls the editor for editing the selected list. A list consists of any number of frequency/level value pairs. The currently selected list is displayed.

	Frequency/Hz	Power/dBm
1	9 000.000	-145.00
2	19 000.000	-140.00
3	29 000.000	-135.00
4	39 000.000	-130.00
5	49 000.000	-125.00
6	59 000.000	-120.00
7	69 000.000	-115.00
8	79 000.000	-110.00
9	89 000.000	-105.00
10	99 000.000	-100.00
11		

Goto Edit Save As... Save

"Frequency / Hz" Enter the frequency of the frequency/power value pair.

SCPI command:

[\[:SOURce<hw>\]:LIST:FREQuency](#) on page 544

"Power /dBm" Enter the level of the frequency/power value pair.

SCPI command:

[\[:SOURce<hw>\]:LIST:POWer](#) on page 548

"Goto" Selects row for editing.



If "Goto row" is selected, a window opens for entering the requested row.

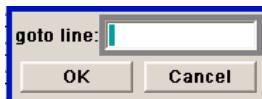

"Edit" Calls a selection of possible actions described below.

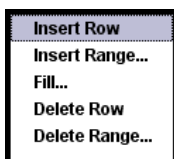

"Insert Row" Inserts a new row before the marked row.

"Insert Range" Inserts new rows before the marked row. The number of rows to be inserted can be defined in an entry window.

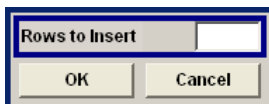

"Fill..." Opens a sub menu for defining a set of list values to be automatically entered in the List Mode table (see ["Filling the List Mode Data automatically"](#) on page 211).

"Delete Row" Deletes the marked row.

"Delete Range..." Allows to delete any number of rows starting with the marked row. The number of rows to be deleted can be defined in an entry window.

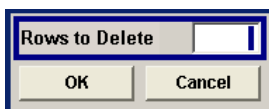

"Save as" Open the file menu to save the list under a new name. Each list is saved to the R&S Signal Generator CompactFlash™ Card as a separate file with the file prefix *.lsw. The file name and the directory to which the file is saved are user-selectable.

"Save" The list is saved under its current name.

List Range In - List Mode

Defines an index range in the current list by setting the start and stop index. Only the values in the selected index range are processed in List mode, all other list entries are ignored.

SCPI command:

[:SOURce<hw>] :LIST:INDEX:START on page 546

[:SOURce<hw>] :LIST:INDEX:STOP on page 546

Trigger Input Slope

Sets the polarity of the active slope of an applied instrument trigger.

This setting affects the INST TRIG input (BNC connector at the rear of the instrument).

"Positive" The rising edge of the trigger signal is active.

"Negative" The falling edge of the trigger signal is active.

SCPI command:

[\[:SOURce\]:INPut:TRIGger:SLOPe](#) on page 525

Import/Export

Lists can be imported from externally created files or exported into text or CSV-files. The import/export settings are available after clicking the "Import/Export" button.

Import/Export - List Mode

Expands the menu with the area for import and export of list mode files.

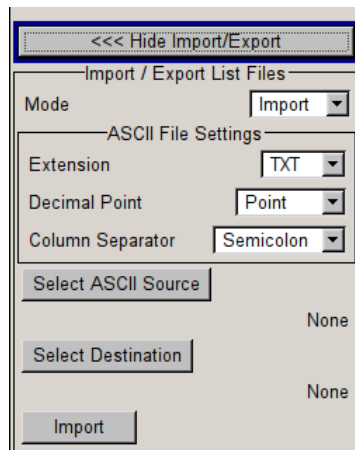

Externally edited Excel tables with frequency/level pairs can be imported as text or CSV-files and used for list mode.

On the other hand, internally created list mode lists can be exported as text or CSV-files.

Mode - List Mode

Selects if list mode lists should be imported or exported. The settings offered below depend on the selected mode.

SCPI command:

[\[:SOURce<hw>\]:LIST:DEXChange:MODE](#) on page 543

Extension - List Mode

Selects the file extension of the ASCII file to be imported or exported. Selection TXT (text file) or CSV (Excel file) is available.

SCPI command:

[\[:SOURce<hw>\]:LIST:DEXChange:AFILe:EXTension](#) on page 540

Decimal Point - List Mode

Selects the decimal separator used in the ASCII data between '.' (decimal point) and ',' (comma) with floating-point numerals.

SCPI command:

[\[:SOURce<hw>\]:LIST:DEXChange:AFILe:SEParator:DECimal](#) on page 542

Column Separator- List Mode

Selects the separator between the frequency and level column of the ASCII table.

SCPI command:

[\[:SOURce<hw>\]:LIST:DEXChange:AFILe:SEParator:COLumn](#) on page 541

Select ASCII Source / Destination - List Mode

Calls the "File Manager" for selecting the ASCII file to be imported into a list mode list (source) or the ASCII file the list mode list is exported (destination) in.

SCPI command:

[\[:SOURce<hw>\]:LIST:DEXChange:AFILe:SELect](#) on page 541

Select Destination / Source - List Mode

Calls the "File Manager" for selecting the list mode list to be exported (source) into an ASCII file or the destination for the ASCII file to be imported (destination) in.

SCPI command:

[\[:SOURce<hw>\]:LIST:DEXChange:SELect](#) on page 543

Import / Export - List Mode

Starts the export or import of the selected file.

When import is selected, the ASCII file is imported as list mode list.

When export is selected, the list mode list is exported into the selected ASCII file.

SCPI command:

[\[:SOURce<hw>\]:LIST:DEXChange:EXECute](#) on page 542

Filling the List Mode Data automatically

The "Fill List Mode Data" menu enables you to automatically set the values in the List Mode table.

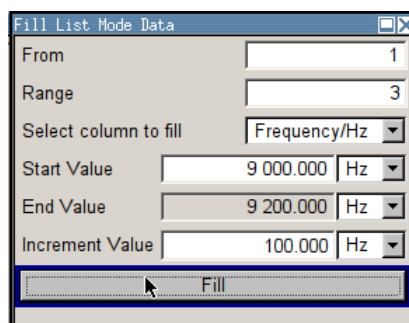

The start line and the number of rows to be filled are defined under "From" and "Range".

The column to be filled is selected under "Select column to fill". Depending on the selection here, the default for start, end, and increment value are set. As the settings are interdependent, a change of one parameter may result in the automatic change of one or more of the other parameters.

The filling of the column with the selected value settings is started with button "Fill".



The list entries are only computed when the "Fill" button is pressed.

From

Sets the start value of the index range.

SCPI command:

n.a.

Range

Sets the range for filling the table.

SCPI command:

n.a.

Select column to fill

Selects either the frequency or the level column to be filled with the value defined below.

SCPI command:

n.a.

Start value

Sets the start value for the frequency or the level entries.

SCPI command:

n.a.

End value

Sets the end value for the frequency or the level entries.

SCPI command:

n.a.

Increment value

Sets the increment for the frequency or the level entries.

SCPI command:

n.a.

Fill

Fills the selected column in the set range with values, starting with the start value and using the set increment.

SCPI command:

n.a.

5.4 Modulation

5.4.1 Overview of Modulation

The R&S SMA provides amplitude modulation (AM), frequency modulation (analog and digital), phase modulation (analog and digital), pulse modulation and chirp modulation. In addition, the RF signal can be modulated with a wide variety of internal modulation waveforms, e.g. sine waves, triangle/rectangular/trapeze signals, and noise. Test signals for avionic systems can be generated VOR (VHF Omnidirectional Range), ILS-GS (Instrument Landing System - Glide Slope), ILS-LOC (Instrument Landing System - Localizer) and Marker Beacon).

Analog amplitude and pulse modulation are available for the basic unit (R&S SMA + frequency option R&S SMA-B10x) without additional equipment options. A standard LF generator and a pulse generator are provided for internal modulation.

Frequency modulation (FM) and phase modulation (PhiM) require option R&S SMA-B20 (FM/PhiM Modulator) or R&S SMA-B22 (Enhanced Phase Noise Performance and FM/PhiM Modulator). Chirp modulation is available with one of these options and an interface board with part number 1400.0530.02.

Option Multifunction Generator, R&S SMA-K24, provides a second LF Generator and a Noise generator. The LF Generator can be used as a second modulation source with extended frequency range and selectable signal shapes. The noise source provides white noise with selectable bandwidth and level distribution as additional modulation source.

Extended pulse modulation features are provided by option R&S SMA-K23, Pulse Generator. Option R&S SMA-K27, Pulse Train, enables generation of pulse trains.

The test signals for avionic systems are available with option R&S SMA-K25, VOR/ILS modulation. DME modulation requires option R&S SMA-K26.

Settings for the modulation are made in separate modulation menus. These menus can be accessed in the block diagram by way of the "Modulation" function block, or by means of the menu with the same name which is opened using the MENU key.

5.4.1.1 Enabling/Disabling Analog Modulations using the MOD On/Off Key

The MOD ON/OFF key switches the modulations on and off.

MOD ON/OFF

Press the MOD ON/OFF key to enable/disable analog modulations.

Pressing the key again restores the status that was active before the last switch-off. "MOD OFF" is displayed in the info line of the header next to the "Level" field.

SCPI command:

`[:SOURce<hw>] :MODulation [:ALL] :STATe` on page 557

5.4.1.2 Modulation Sources

The following modulations use internal and external modulation sources:

- Amplitude modulation
- Pulse modulation
- Frequency modulation
- Phase modulation
- VOR/ILS modulation

Marker Beacon modulation only uses the internal modulation sources. For external digital FM and PhiM only external modulation sources can be used.

Internal Modulation Sources

Two LF generators, a noise generator and a pulse generator are available as internal modulation sources for a fully equipped instrument.

The first LF generator supplies sinusoidal signals. The second LF generator supplies signals with selectable shapes. The frequency range is extended. The pulse generator provides single and double pulse modulation with selectable pulse widths and periods or a user-definable pulse train. The LF generator is also used for the generation of the VOR/ILS signals.

The noise generator supplies white noise with selectable bandwidth and level distribution.

See also [chapter 5.5.1, "Overview of LF Generator"](#), on page 291.

External Modulation Sources

The modulation inputs AM EXT, FM/PM EXT and PULSE EXT at the rear of the instrument are provided as the external modulation source for amplitude, pulse, frequency and phase modulation. The external signal for digital FM/PM modulation is fed in via the AUX I/O interface. The AM EXT connector can be used to feed in external VOR/ILS signal in addition.

The external modulation signal at the input must have a voltage of $U_S = 1 \text{ V}$ ($U_{\text{EFF}} = 0.707 \text{ V}$) in order to achieve the displayed modulation depth and range. The input voltage should not exceed 1.1 Vs, otherwise modulation distortions might occur. With external pulse modulation, the switching point is max. 2.4 V and the voltage at the input should not exceed 5 V. The maximum modulation frequency is 10 MHz for frequency and phase modulation.

Simultaneous Operation of Several Modulations or Other Operating Modes

The table shows the modulations and operating modes which can be activated simultaneously (+) or which deactivate each other (-).

	AM	FM	dig FM	PhiM	dig PhiM	Pulse	VOR	ILS	MB	ADF	DME
Amplitude modulation (AM)	/	+	+	+	+	-	-	-	-	-	-
Frequency modulation (FM)	+	/	-	-	-	+	+	+	+	+	+

	AM	FM	dig FM	PhiM	dig PhiM	Pulse	VOR	ILS	MB	ADF	DME
Digital Frequency modulation (FM)	+	-	/	-	+	+	+	+	+	+	+
Phase modulation (PhiM)	+	-	-	/	+	+	+	+	+	+	+
Digital Phase modulation (PhiM)	+	-	-	-	/	-	-	-	-	-	-
Pulse modulation	-	+	+	+	+	/	-	-	-	-	-
VOR modulation	-	+	+	-	+	-	/	-	-	-	-
ILS modulation	-	+	+	-	+	-	-	/	-	-	-
Marker Beacon modulation (MB)	-	+	+	-	+	-	-	-	/	-	-
ADF modulation	-	+	+	-	+	-	-	-	-	/	-
DME modulation	-	+	+	-	+	-	-	-	-	-	/

5.4.2 Amplitude Modulation (AM)

An internal and/or external source can be selected for amplitude modulation. Two LF modulation generators and a noise generator are available as the internal source for a fully equipped instrument. Two-tone AM is possible by simultaneously switching on the external and internal or both internal sources.

The AM EXT input connector for external feed of analog modulation signals is at the front of the instrument. The coupling mode of the input (AC or DC) can be selected.

The AM modulation depth is limited by the maximum peak envelope power (PEP).

5.4.2.1 Amplitude Modulation Settings

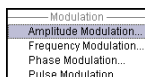

To open the "Amplitude Modulation" dialog, select "Modulation > Configure > Amplitude Modulation" or use the MENU key under "Modulation".

In the upper section of the dialog, the modulation source is selected and the modulation switched on. The modulation source can be selected independently for the different modulation types and the LF output.

The configuration of the selected external and/or internal modulation source is performed in the lower section of the dialog or in the "LF Output" dialog (internal source only).

These settings affect all modulations which use the same modulation source.

For a fully equipped instrument two LF generators and a noise generator are available as internal sources.

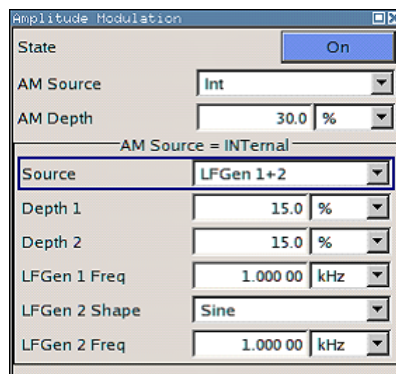

If an avionic modulation (VOR/ILS) is activated this modulation is deactivated and an error message indicated in the info line.

State

Activates/deactivates AM modulation.

SCPI command:

`[:SOURce<hw>] :AM:STATE` on page 457

AM Source

Selects the source for the AM signal.

For a fully equipped instrument two LF generators and a noise generator are available as internal sources.

"Internal" Selects the internal LF generator as the source for AM modulation.

"External" Selects the external source.
The external signal is input via the AM EXT connector.

"Intern + Extern" Selects the internal and external source at the same time. This setting enables two-tone AM modulation.

SCPI command:

`[:SOURce<hw>] :AM:SOURce` on page 456

AM Depth

Sets the modulation depth in percent.

Note: With two-tone modulation, observe that the set modulation depth is valid for both signals and the sum modulation depth is determined by doubling the set modulation depth. This results in overmodulation if the maximal value for modulation depth is exceeded (see data sheet).

SCPI command:

`[:SOURce<hw>] :AM[:DEPTH]` on page 454

Internal Source

Source Internal only

Selects which internal modulation source is used. The available selection depends on the options fitted.

"None"	Switches off all internal modulation sources.
"LFGGen1 / LFGGen2"	Selects one of the internal LF generators as the source for AM modulation.
"LFGGen1+2"	Selects both internal LF generators as the source for AM modulation. LF frequency and modulation depth can be set separately. The added modulation depths of the two modulation generators must not exceed the overall modulation depth. This selection enables two-tone AM modulation.
"Noise"	Selects noise signal. The modulation signal is white noise either with Gaussian distribution or equal distribution. This setting affects all analog modulations which use the noise generator as the internal modulation source. See also chapter 5.5.3.2, "Noise Settings" , on page 300.
"LFGGen1+Noise / LFGGen2+Noise"	Selects one LF generator as the source for AM modulation and the noise signal. In addition to the AM modulation signal, white noise is used as modulation signal.

SCPI command:

[\[:SOURce<hw>\]:AM:INTernal:SOURce](#) on page 455

Depth 1/Depth 2

Source Internal, LFGGen1+2 only

Selects the modulation depth for the two LF generators. The sum of the two values must not exceed the overall modulation depth set in the upper part of the dialog.

SCPI command:

[\[:SOURce<hw>\]:AM:INTernal<ch>:DEPTH](#) on page 455

LF Gen 1/2 Freq

Source Internal, LFGGen1+2 only

Sets the frequency of the two LF generators.

SCPI command:

[\[:SOURce\]:LFOutput<ch>:FREQUENCY](#) on page 526

LF Gen 2 Shape

Source Internal, LFGGen2 only

Selects the shape of the second LF generator signal. In case of selection Trapeze, additional settings concerning the duration of the single trapeze elements can be made (see [chapter 5.5.3.1, "LF Output Dialog"](#), on page 298).

SCPI command:

[\[:SOURce\]:LFOutput<ch>:SHAPE](#) on page 535

AM Sensitivity

(Source External only)

Displays the input sensitivity of the AM EXT input in %/V.

The modulation depth entered under "AM Depth" is reached with 1 volt modulation of the input.

SCPI command:

`[:SOURce<hw>] :AM:SENSitivity?` on page 456

AM External Coupling

(Source External only)

Selects the coupling mode (AC or DC) for external feed.

Note: Coupling for external feed via input EXT MOD can be set independently for all modulations with external source.

SCPI command:

`[:SOURce<hw>] :AM:EXTernal:COUpling` on page 455

5.4.2.2 Noise Settings

In case of internal modulation source, the settings for the noise source are offered in the "Noise" section. This setting affects all analog modulations which use the noise generator as the internal modulation source. The settings are described in [chapter 5.5.3.2, "Noise Settings"](#), on page 300.

5.4.3 Frequency Modulation (FM)

Frequency modulation requires option R&S SMA-B20 (FM/PhiM Modulator) or option R&S SMA-B22 (Enhanced Noise Performance and FM/PhiM Modulator).

An internal and/or external source can be selected for frequency modulation. Two LF modulation generators and a noise generator are available as internal sources for a fully equipped instrument. Two-tone FM is possible by simultaneously switching on the external and internal source.

The FM/PM EXT input connector for external feed of analog modulation signals is at the front of the instrument. The coupling mode of the input (AC or DC) and the input impedance (50 Ohm or high) can be selected.

The digital FM signal is fed in via the AUX I/O interface.

Selection between Low Noise mode (with better signal/noise ratio, but reduced setting range for modulation bandwidth and deviation, see data sheet) and standard mode is possible (option R&S SMA-B22 only).



It is not possible to use analog frequency modulation simultaneously with digital frequency modulation or with analog or digital phase modulation.

5.4.3.1 Frequency Modulation Settings

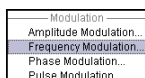

To open the "Frequency Modulation" menu, select "Modulation > Configure > Frequency Modulation" or use the MENU key under "Modulation".

In the upper section of the menu, the modulation source is selected and the modulation is switched on. The modulation source can be selected independently for the different modulation types and the LF output.

For a fully equipped instrument two LF generators and a noise generator are available as internal sources.

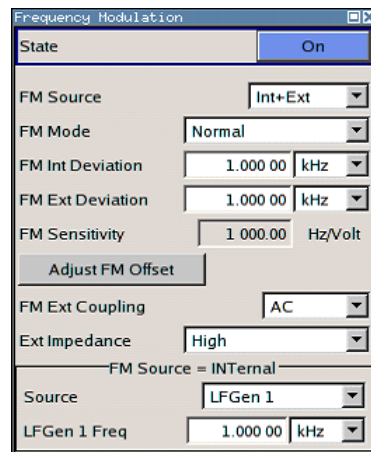

State

Activates/deactivates FM modulation.

Activation of FM deactivates phase modulation.

SCPI command:

[:SOURce<hw>] :FM:STATe on page 500

FM Source

Selects the source for the FM signal.

- "Internal" Selects the internal LF generator as the source for FM modulation.
- "External" Selects the external source.
The external signal is input via the FM/PM EXT connector.
- "Internal + External" Selects the internal and external source at the same time.
This setting enables two-tone FM modulation.
- "Ext digital" Selects the external source. The external digital signal is input via the AUX I/O connector.
This mode is provided for fast frequency hopping. The FM-Data bus is directly connected to the DDS of the synthesizer module. Thus, very fast frequency hopping (settling times of ≤ 10 us) is possible for frequency bandwidth up to 40/80 MHz, depending on the RF frequency. The accuracy of the set frequency deviation is limited to 50ppm. The binary format of the external digital data can be selected (see "Binary Format " on page 222).

SCPI command:

[:SOURce<hw>] :FM:SOURce on page 499

FM Mode

Selects the mode for the frequency modulation.

- "Normal" The maximum range for modulation bandwidth and FM deviation is available.
- "Low Noise" (requires option R&S Signal Generator-B22)
Frequency modulation with phase noise and spurious characteristics close to CW mode. The range for modulation bandwidth and FM deviation is reduced (see data sheet).

SCPI command:

[\[:SOURce<hw>\]:FM:MODE](#) on page 498

FM Deviation

Sets the modulation deviation in Hz.

The deviation is given as the absolute deviation in relation to the set center frequency, e.g. a deviation 5 MHz at a center frequency of 1 GHz leads to a frequency modulation between 995 MHz and 1005 MHz.

The maximal deviation depends on the RF frequency set and the selected modulation mode (see data sheet). It is possible to enter a deviation that is too high for a certain RF frequency or to vary the RF frequency to a range in which the deviation can no longer be set. In this case the maximally possible deviation is set and an error message is displayed.

The deviation of the internal source must not exceed the deviation of the external source in case of modulation source "Int+Ext".

SCPI command:

[\[:SOURce<hw>\]:FM\[:DEVIation\]](#) on page 496

Internal Source

Source Internal only

Selects which internal modulation source is used. The available selection depends on the options fitted.

- "None" Switches off all internal modulation sources.
- "LFGGen1 / LFGGen2" Selects one of the internal LF generators as the source for FM modulation.
- "LFGGen1+2" Selects both internal LF generators as the source for FM modulation. LF frequency and modulation depth can be set separately. The added modulation depths of the two modulation generators must not exceed the overall modulation depth.
This selection enables two-tone FM modulation.
- "Noise" Selects noise signal. The modulation signal is white noise either with Gaussian distribution or equal distribution.
This setting affects all analog modulations which use the noise generator as the internal modulation source.
See also [chapter 5.5.3.2, "Noise Settings"](#), on page 300.

"LFGen1+Noise / LFGen2+Noise" Selects one LF generator as the source for FM modulation and the noise signal. In addition to the FM modulation signal, white noise is used as modulation signal.

SCPI command:

`[:SOURce<hw>] :FM:INTernal:SOURce` on page 498

Deviation 1/Deviation 2

Source Internal, LFGen1+2 only

Selects the deviation for the two frequency modulation signals. The sum of the two values must not exceed the overall modulation deviation set in the upper part of the menu.

SCPI command:

`[:SOURce<hw>] :FM:INTernal<ch>:DEVIation` on page 498

LF Gen 1/2 Freq

Source Internal, LFGen1+2 only

Sets the frequency of the two LF generators.

SCPI command:

`[:SOURce] :LFOutput<ch>:FREQuency` on page 526

LF Gen 2 Shape

Source Internal, LFGen2 only

Selects the shape of the second LF generator signal. In case of selection Trapeze, additional settings concerning the duration of the single trapeze elements can be made (see [chapter 5.5.3.1, "LF Output Dialog"](#), on page 298).

SCPI command:

`[:SOURce] :LFOutput<ch>:SHAPE` on page 535

FM Sensitivity

(Source External only)

Displays the input sensitivity of the FM/PM EXT input in Hz/V.

The modulation depth entered under "FM Depth" is reached with 1 Volt (= U_{peak}) of the input signal.

Note: The input voltage should not exceed $1.1 V_p$ otherwise modulation distortions might occur.

SCPI command:

`[:SOURce<hw>] :FM:SENSitivity?` on page 499

Adjust FM Offset

Starts the adjustment for the FM/PhiM modulator. The option is adjusted with respect to DC-offset.

SCPI command:

`:CALibration<hw>:FMOffset [:MEASure] ?` on page 362

FM External Coupling

(Source External only)

Selects the coupling mode (AC or DC) for external feed.

Note: Coupling for external feed via input EXT MOD can be set independently for all modulations with external source.

"AC" The d.c. voltage content is separated from the modulation signal.

"DC" The modulation signal is not altered.

SCPI command:

[\[:SOURce<hw>\]:FM:EXTernal:COUpling](#) on page 496**External Input Impedance**

(Source External only)

Selects the impedance for external feed via the FM/PM EXT input.

Selection 50 Ohm and high (>100 kOhm) is available.

Note: This setting affects all analog modulations which use the external modulation source.

SCPI command:

[\[:SOURce<hw>\]:INPut:MODext:IMPedance](#) on page 525**Binary Format**

Source External only

Selects the binary format for external digital frequency modulation (see [table 5-2](#)). The data is input via the AUX I/O interface.**NOTICE!** Risk of instrument damage!. The maximum possible input voltage is 3.3 V dc.*Table 5-2: Binary data formats*

Scale	Example for set frequency deviation = 10 MHz	Offset Binary	Two's Complement
+ full scale	10 MHz	1111....1111	0111....1111
+0.75 full scale	7.5 MHz	1110....0000	0110....0000
+0.5 full scale	5 MHz	1100....0000	0100....0000
+0.25 full scale	2.5 MHz	1010....0000	0010....0000
0	0 MHz	1000....0000	0000....0000
-0.25 full scale	-2.5 MHz	0110....0000	1110....0000
-0.5 full scale	- 5 MHz	0100....0000	1100....0000
- 0.75full scale	-7.5 MHz	0010....0000	1010....0000
- full scale + 1LSB	- 9.999695 MHz	0000....0001	1000....0001
- full scale	- 10 MHz	0000....0000	1000....0000

Table 5-3: Pin connection for input of digital FM data via AUX I/O connector

Connection	Parallel data input with 16-bit word width for digital FM modulation data.
11 - FM_DAT	FM_DATA 15 (MSB)
12 - FM_DAT	FM_DATA 14
13 - FM_DAT	FM_DATA 13
14 - FM_DAT	FM_DATA 12
15 - FM_DAT	FM_DATA 11
16 - FM_DAT	FM_DATA 10
17 - FM_DAT	FM_DATA 9
18 - FM_DAT	FM_DATA 8
19 - FM_DAT	FM_DATA 7
20 - FM_DAT	FM_DATA 6
21 - FM_DAT	FM_DATA 5
22 - FM_DAT	FM_DATA 4
23 - FM_DAT	FM_DATA 3
24 - FM_DAT	FM_DATA 2
25 - FM_DAT	FM_DATA 1
26 - FM_DAT	FM_DATA 0 (LSB)

"Offset Binary" Offset Binary code is selected. This code represents analog values between full scale and minus full scale.

"Two's Complement" Two's Complement code is selected.

SCPI command:

`[:SOURce<hw>] :FM:EXTernal:DIGital:BFORmat` on page 497

5.4.3.2 Noise Settings

In case of internal modulation source, the settings for the noise source are offered in the "Noise" section. This setting affects all analog modulations which use the noise generator as the internal modulation source. The settings are described in [chapter 5.5.3.2, "Noise Settings"](#), on page 300.

5.4.4 Phase Modulation (PhiM)

Phase modulation requires option R&S SMA-B20 (FM/PhiM Modulator) or option R&S SMA-B22 (Enhanced Noise Performance and FM/PhiM Modulator).



It is not possible to use analog phase modulation simultaneously with digital phase modulation or with analog or digital frequency modulation.

An internal and/or external source can be selected for phase modulation. Two LF modulation generators and a noise source are available as internal sources for a fully equipped instrument.

The FM/PM EXT input connector for external feed of analog modulation signals is at the front of the instrument. The coupling mode of the input (AC or DC) and the input impedance (50 Ohm or high) can be selected.

The digital PM signal is fed in via the AUX I/O interface.

Selection between the following modulation modes is possible:

- "High Bandwidth" mode with full setting range for modulation bandwidth and limited PhiM deviation.
- "Low Noise" mode with better signal/noise ratio, but reduced setting range for modulation bandwidth and deviation (see data sheet)
- "High Deviation" mode with full setting range for PhiM deviation and a reduced setting range for modulation bandwidth. Phase noise is reduced in the lower modulation frequency range compared to the default mode.

5.4.4.1 Phase Modulation Menu

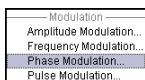

To open the "Phase Modulation" menu, select "Modulation > Configure > Phase Modulation" or use the MENU key under "Modulation".

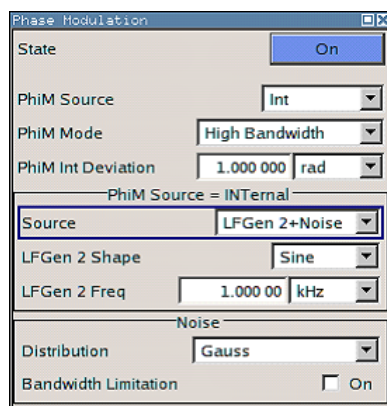

In the upper section of the menu, the modulation source is selected and the modulation switched on. The modulation source can be selected independently for the different modulation types and the LF output.

The configuration of the selected external and/or internal modulation source is performed in the lower section of the menu (internal source only).

These settings affect all modulations which use the same modulation sources.

For a fully equipped instrument two LF generators and a noise generator are available as internal sources.

State

Activates/deactivates PhiM modulation.

Activation of PhiM deactivates frequency modulation.

SCPI command:

[:SOURce<hw>] : PM : STATE on page 565

PhiM Source

Selects the source for the PhiM signal.

For a fully equipped instrument two LF generators and a noise generator are available as internal sources.

"Internal" Selects the internal LF generator as the source for PhiM modulation.

"External" Selects the external source.
The external signal is input via the FM/PM EXT connector.

"Internal + External" Selects the internal and external source at the same time.

"Ext digital" Selects the external source. The external digital signal is input via the AUX I/O connector.

SCPI command:

[:SOURce<hw>] : PM : SOURce on page 565

PhiM Mode

Selects the mode for the phase modulation.

"High Bandwidth" The maximum range for modulation bandwidth is available. However, phase noise is increased for low frequencies. The range for PhiM deviation is limited.
This mode is recommended for high modulation frequencies.

"High Deviation" The maximum range for PhiM deviation is available. Phase noise is improved for low frequencies compared to the default mode. The range for modulation frequency is limited (see data sheet).
This mode is recommended for low modulation frequencies and/or high PhiM deviation.

"Low Noise" (with option R&S SMA-B22 only)
Phase modulation with phase noise and spurious characteristics close to CW mode. The range for modulation bandwidth and PM deviation is limited (see data sheet).
This mode is useful for generating a tailed CW signal.

SCPI command:

[:SOURce<hw>] : PM : MODE on page 564

PhiM Deviation

Sets the modulation depth in RAD or degrees.

The maximal deviation depends on the RF frequency set and the selected modulation mode (see data sheet). It is possible to enter a deviation that is too high for a certain RF frequency or to vary the RF frequency to a range in which the deviation can no longer be set. In this case the maximally possible deviation is set and an error message is displayed.

SCPI command:

`[:SOURce<hw>] :PM[:DEVIation]` on page 561

Internal Source

Source Internal only

Selects which internal modulation source is used. The available selection depends on the options fitted.

"None"	Switches off all internal modulation sources.
"LFGGen1 / LFGGen2"	Selects one of the internal LF generators as the source for phase modulation.
"LFGGen1+2"	Selects both internal LF generators as the source for phase modulation. LF frequency and modulation depth can be set separately. The added modulation depths of the two modulation generators must not exceed the overall modulation depth.
"Noise"	Selects noise signal. The modulation signal is white noise either with Gaussian distribution or equal distribution. This setting affects all analog modulations which use the noise generator as the internal modulation source. See also chapter 5.5.3.2, "Noise Settings" , on page 300.
"LFGGen1+Noise / LFGGen2+Noise"	Selects one LF generator as the source for phase modulation and the noise signal. In addition to the phase modulation signal, white noise is used as modulation signal.

SCPI command:

`[:SOURce<hw>] :PM:INTernal:SOURce` on page 563

Deviation 1/Deviation 2

Source Internal, LFGGen1+2 only

Selects the deviation for the two frequency modulation signals. The sum of the two values must not exceed the overall modulation deviation set in the upper part of the menu.

SCPI command:

`[:SOURce<hw>] :PM:INTernal<ch>:DEVIation` on page 563

LF Gen 1/2 Freq

Source Internal, LFGGen1+2 only

Sets the frequency of the two LF generators.

SCPI command:

`[:SOURce] :LFOutput<ch>:FREQuency` on page 526

LF Gen 2 Shape

Source Internal, LFGGen2 only

Selects the shape of the second LF generator signal. In case of selection Trapeze, additional settings concerning the duration of the single trapeze elements can be made (see [chapter 5.5.3.1, "LF Output Dialog"](#), on page 298).

SCPI command:

`[:SOURce] :LFOutput<ch> :SHAPE` on page 535

PhiM Sensitivity

(Source External only)

Displays the input sensitivity of the FM/PM EXT input in RAD/V.

The modulation depth entered under "PhiM Depth" is reached with 1 volt ($=U_{\text{peak}}$) of the input signal.

Note: The input voltage should not exceed $1.1 V_p$ otherwise modulation distortions might occur.

SCPI command:

`[:SOURce<hw>] :PM :SENSitivity?` on page 564

Mod External Coupling

Selects the coupling mode (AC OR DC) for external feed.

Note: Coupling for external feed via input EXT MOD can be set independently for all modulations with external source.

"AC" The DC voltage content is separated from the modulation signal.

"DC" The modulation signal is not altered.

SCPI command:

`[:SOURce<hw>] :PM :EXTernal :COUpling` on page 562

External Input Impedance

(Source External only)

Selects the impedance for external feed via the FM/PM EXT input.

Selection 50 Ohm and high (>100 kOhm) is available.

Note: This setting affects all analog modulations which use the external modulation source.

SCPI command:

`[:SOURce<hw>] :INPut :MODext :IMPedance` on page 525

Ext PhiM Binary Format

Source External only

Selects the binary format for external digital frequency modulation (see [table 5-4](#)). The data is input via the AUX I/O interface.

NOTICE! Risk of instrument damage!. The maximum possible input voltage is 3.3 V dc.

Table 5-4: Binary data formats

Scale	Example for set phase deviation = 120 DEG	Offset Binary	Two's Complement
+ full scale	120 DEG	1111....1111	0111....1111
+0.75 full scale	90 DEG	1110....0000	0110....0000
+0.5 full scale	60 DEG	1100....0000	0100....0000
+0.25 full scale	30 DEG	1010....0000	0010....0000
+ 0	0 DEG	1000....0000	0000....0000
-0.25 full scale	-30 DEG	0110....0000	1110....0000
-0.5 full scale	- 60 DEG	0100....0000	1100....0000
- 0.75full scale	- 90 DEG	0010....0000	1010....0000
- full scale + 1LSB		0000....0001	1000....0001
- full scale	- 120 DEG	0000....0000	1000....0000

Table 5-5: Pin connection for input of digital PM data via AUX I/O connector

Connection	Parallel data input with 16-bit word width for digital PM modulation data.
11 - FM_DAT	FM_DATA 15 (MSB)
12 - FM_DAT	FM_DATA 14
13 - FM_DAT	FM_DATA 13
14 - FM_DAT	FM_DATA 12
15 - FM_DAT	FM_DATA 11
16 - FM_DAT	FM_DATA 10
17 - FM_DAT	FM_DATA 9
18 - FM_DAT	FM_DATA 8
19 - FM_DAT	FM_DATA 7
20 - FM_DAT	FM_DATA 6
21 - FM_DAT	FM_DATA 5
22 - FM_DAT	FM_DATA 4
23 - FM_DAT	FM_DATA 3
24 - FM_DAT	FM_DATA 2
25 - FM_DAT	FM_DATA 1
26 - FM_DAT	FM_DATA 0 (LSB)

5.4.4.2 Noise Settings

In case of internal modulation source, the settings for the noise source are offered in the "Noise" section. This setting affects all analog modulations which use the noise generator

as the internal modulation source. The settings are described in [chapter 5.5.3.2, "Noise Settings"](#), on page 300.

5.4.5 Pulse Modulation (PM)

Pulse modulation is available for the basic unit (R&S SMA + frequency option R&S SMA-B10x) without additional equipment options.

A standard pulse generator is available for internal modulation. Internal Pulse Modulation with extended features, e.g. generation of double pulse, requires option R&S SMA-K23, Pulse Generator. Option R&S SMA-K27, Pulse Train, enables generation of pulse trains.

An internal or external source can be selected for pulse modulation. In case of external source, the external signal is input via the PULSE EXT connector at the rear of the instrument. In case of internal source, this connector can be used as external trigger or gate signal input for internal pulse modulation. The polarity and input impedance of the connector can be selected.

The pulse signal is output at the PULSE VIDEO connector at the rear of the instrument.



Automatic Level Control is deactivated with pulse modulation!

When pulse modulation is activated, the ALC state of the R&S SMA is automatically changed to "ALC OFF" ("Sample & Hold"). In this state, the ALC loop is opened and the output level is not regulated but the level modulator is set directly. In order to set the correct output level, a sample & hold measurement is executed after each frequency or level setting.

In the following cases the nominal ON level is present for typically 3...5 ms after level or frequency setting:

- No attenuator is fitted (frequency option R&S SMA-B103L/B106L)
- in High Power Mode
- in Auto mode if the level is in the High Power range, i.e. the mechanical relay bypass is switched.

The level is decreased by 30 dB during "Sample&Hold" measurement.

5.4.5.1 Pulse Modulation Settings

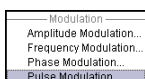

To open the "Pulse Modulation" menu, select "Modulation > Configure > Pulse Modulation" or use the MENU key under "Mod".

In the upper section of the menu, the modulation source is selected and the modulation switched on. The configuration of the selected external and/or internal modulation source is performed in the lower section of the menu.

The menu varies according to the selected modulation source.

In case of modulation source pulse generator, the settings for the pulse characteristics and the trigger are offered in the "Pulse Generator" section of the "Pulse Modulation" dialog. Option R&S SMA-K23 offers extended features, e.g. generation of double pulse or selection of trigger mode. For description of the pulse generator dialog, see [chapter 5.5.4, "Pulse Generator"](#), on page 301.

Option R&S SMA-K27 enables the generation of pulse trains. For description of the pulse train dialog, see [chapter 5.5.4.2, "Pulse Train Generation"](#), on page 307.

State

Activates/deactivates pulse modulation.

Activation of pulse modulation deactivates ALC and power ramping.

When the internal modulation source (pulse generator) is selected, the pulse generator is switched on automatically and the video/sync signal is output at the PULSE VIDEO output at the rear of the instrument. Signal output can be switched off in the "Pulse Generator" dialog (see [chapter 5.5.4, "Pulse Generator"](#), on page 301).

SCPI command:

[\[:SOURce<hw>\]:PULM:STATe](#) on page 581

Source

Selects the source for the pulse modulation signal.

- "Pulse Generator" Selects the Pulse Generator as modulation source. The settings for the pulse characteristics and the trigger are offered in the "Pulse Generator" section of the "Pulse Modulation" menu. The internal pulse generator signal is provided at the PULSE VIDEO output, the sync signal at the PULSE SYNC output.
- Without option R&S SMA-K23:
The internally generated rectangular signal is used for the pulse modulation. The frequency of the internal signal can be set in the LF Output menu.
 - With option R&S SMA-K23:
If option R&S SMA-K23 is installed, the characteristics of the generated pulse can be set in a wide range, and double pulse generation is possible. The settings are made in the "Pulse Generator" section of the menu.
- "External" Selects the external source. The external modulation signal is input via the PULSE EXT connector. The external modulation is provided at the PULSE VIDEO output.

SCPI command:

[\[:SOURce<hw>\]:PULM:SOURce](#) on page 580

Polarity

(External Source only)

Selects the polarity of the modulation signal.

"Normal" The RF signal is **On** while the level is high at the modulation input.

"Inverted" The RF signal is **Off** while the level is high at the modulation input.

SCPI command:

[\[:SOURce<hw>\]:PULM:POLarity](#) on page 580

5.4.6 Chirp Modulation

Chirp modulation is used in radar technique to achieve pulse compression. Pulse compression increases the sensitivity and resolution of radar systems by modifying transmitted pulses to improve their auto-correlation properties. To chirp the radar signal is one way of accomplishing this. A chirp is a signal in which the frequency increases or decreases over time.

The R&S SMA always uses chirp modulation together with pulse modulation. The modulation signals for FM and Pulse modulator are generated and synchronized internally. The internal pulse generator is used as the modulation source for the pulse modulator and the internal LF generator as source for the frequency modulation. Normal FM mode is used. Using external modulation signals is not possible for chirp modulation.

The following graph shows the FM demodulated signal of chirped pulses with a chirp bandwidth of 80 MHz and a pulse width of 80 us. Chirp direction is up.

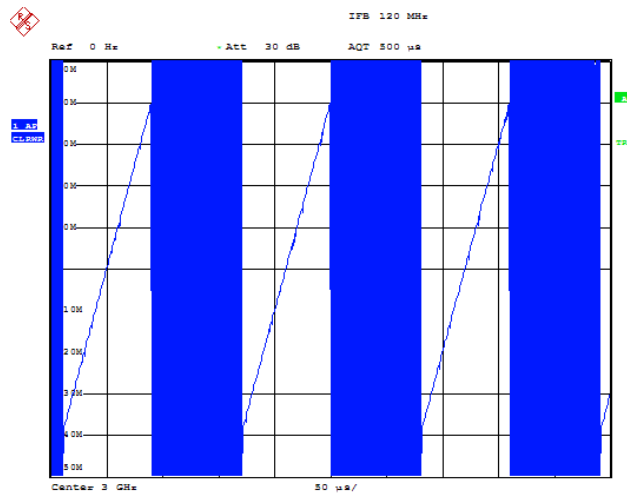

Date: 10.MAR.2008 15:38:01

Chirp modulation is available for the basic unit (R&S SMA + frequency option R&S SMA-B10x) equipped with option R&S SMA-B20 or B22 and interface board with part number 1400.0530.02 or 1400.0552.02.

Chirp Modulation with extended ranges for resolution, pulse width and period requires option R&S SMA-K23, Pulse Generator.

The PULSE EXT connector at the rear of the instrument can be used as external trigger or gate signal input.

The polarity and input impedance of the connector can be selected.

The pulse signal is output at the PULSE VIDEO connector at the rear of the instrument, the sync signal at the PULSE SYNC output.

The FM modulation signal can be output at the LF connector.



All other analog modulations are deactivated during chirp modulation!

When chirp modulation is activated, any active analog modulation is automatically switched off.



Automatic Level Control (ALC) is deactivated with chirp modulation!

When pulse modulation is activated, the ALC state of the R&S SMA is automatically changed to "ALC OFF" ("Sample & Hold"). In this state, the ALC loop is opened and the output level is not regulated but the level modulator is set directly. In order to set the correct output level, a sample & hold measurement is executed after each frequency or level setting.

In the following cases the nominal ON level is present for typically 3...5 ms after level or frequency setting:

- No attenuator is fitted (frequency option R&S SMA-B103L/B106L)
- in High Power Mode
- in Auto mode if the level is in the High Power range, i.e. the mechanical relay bypass is switched.

The level is decreased by 30 dB during "Sample&Hold" measurement.



The Sample&Hold measurement for the ALC is performed at the chirp center frequency. Therefore, the frequency response of the RF path may result in level errors for the FM modulated carrier especially with high chirp bandwidths.

5.4.6.1 Chirp Modulation Settings

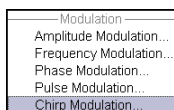

The "Chirp modulation" dialog is opened in the "Modulation" function block or using the MENU key under "Modulation".

In the upper section of the menu, the modulation is configured and switched on. The configuration of the trigger source is performed in the lower section of the menu.

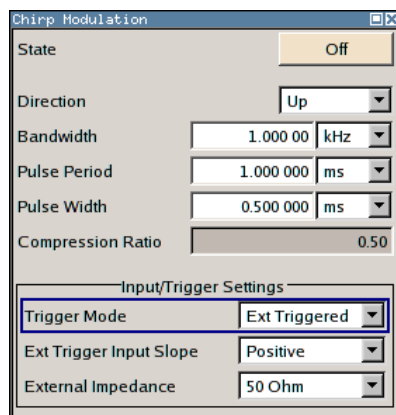

Option R&S SMA-K23 offers an extended range for resolution, pulse period and pulse width settings.

State - Chirp Modulation

Activates/deactivates chirp modulation

Note: Any active modulation is automatically switched off when chirp modulation is activated.

The pulse generator signal is provided at the "PULSE VIDEO" output, the sync signal at the "PULSE SYNC" output.

These outputs are automatically switched on/off according to the chirp modulation state. The FM modulation signal can be output at the LF connector.

SCPI command:

[\[:SOURce<hw>\]:CHIRp:STATe](#) on page 459

Direction - Chirp Modulation

Selects the direction of the chirp modulation.

"Up" The chirp starts with the lower frequency.

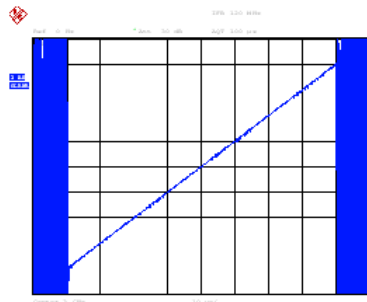

"Down" The chirp starts with the higher frequency.

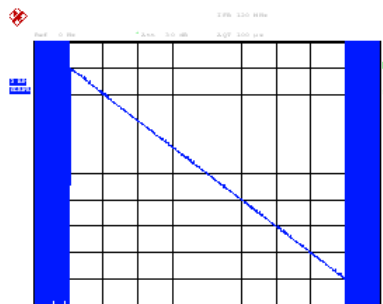

SCPI command:

[\[:SOURce<hw>\]:CHIRp:DIRectiOn](#) on page 458

Bandwidth - Chirp Modulation

Sets the modulation bandwidth in Hz.

The bandwidth denotes the difference between the maximum and minimum frequency, e.g. a bandwidth of 10 MHz at a center frequency of 1 GHz leads to a frequency modulation between 995 MHz and 1005 MHz.

The maximum bandwidth depends on the currently set RF frequency (see data sheet). It is possible to enter a bandwidth that is too high for a certain RF frequency or to vary the RF frequency to a range in which the bandwidth can no longer be set. In this case the maximum possible bandwidth is set and an error message is displayed.

SCPI command:

[\[:SOURce<hw>\]:CHIRp:BANDwidth](#) on page 457

Pulse Period - Chirp Modulation

Sets the period of the generated chirp. Option R&S SMA-K23 provides a resolution of 20 ns.

SCPI command:

`[:SOURce<hw>] :CHIRp:PULSe:PERiod` on page 459

Pulse Width - Chirp Modulation

Sets the width of the generated chirp. The pulse width must be at least 1 us less than the set pulse period. Option R&S SMA-K23 provides a resolution of 20 ns.

SCPI command:

`[:SOURce<hw>] :CHIRp:PULSe:WIDTh` on page 459

Compression Ratio - Chirp Modulation

Indicates the pulse compression ratio, i.e. the product of pulse width [s] and bandwidth [Hz]. Pulse compression increases the range resolution as well as the signal to noise ratio of pulsed signals.

SCPI command:

`[:SOURce<hw>] :CHIRp:COMPression:RATio?` on page 458

Trigger Mode - Chirp Modulation

Selects the trigger mode for chirp modulation signals.

Note: An external trigger signal is supplied via the PULSE EXT connector.

"Auto" The chirp modulation signals are generated continuously.

"Ext Triggered" The chirp modulation signals are triggered by an external trigger event.

"Ext Gated" The chirp modulation signals are gated by an external gate signal.

SCPI command:

`[:SOURce<hw>] :CHIRp:TRIGger:MODE` on page 461

External Trigger Input Slope - Chirp Modulation

(Ext. Triggered only)

Sets the polarity of the active slope of an applied trigger signal.

Note: An external trigger signal is supplied via the PULSE EXT connector.

"Positive" The chirp modulation signals are triggered on the positive slope of the external trigger signal.

"Negative" The chirp modulation signals are triggered on the negative slope of the external trigger signal.

SCPI command:

`[:SOURce<hw>] :CHIRp:TRIGger:EXTernal:SLOPe` on page 460

Gate Input Polarity - Chirp Modulation

(External Gate only).

Selects the polarity of the Gate signal.

Note: An external gate signal is supplied via the PULSE EXT connector.

- "Normal" The chirp modulation signals are generated while the gate signal is high.
- "Inverse" The chirp modulation signals are generated while the gate signal is low.

SCPI command:

`[:SOURce<hw>] :CHIRp:TRIGger:EXTernal:GATE:POLarity` on page 460

External Impedance - Chirp Modulation

(External trigger or gate only)

Selects the input impedance for the external trigger and gate signal input (10 kOhm or 50 Ohm).

SCPI command:

`[:SOURce<hw>] :CHIRp:TRIGger:EXTernal:IMPedance` on page 460

5.4.7 DME Modulation

Option R&S SMA-K26 enables DME modulation on the R&S SMA.

DME (Distance Measurement Equipment) is a radar system which determines the slant distance between the aircraft and the ground station. On the aircraft, the time is measured which the radio signal takes to travel from the aircraft to the ground station and back. The aircraft is equipped with an interrogator and the ground station with a transponder.

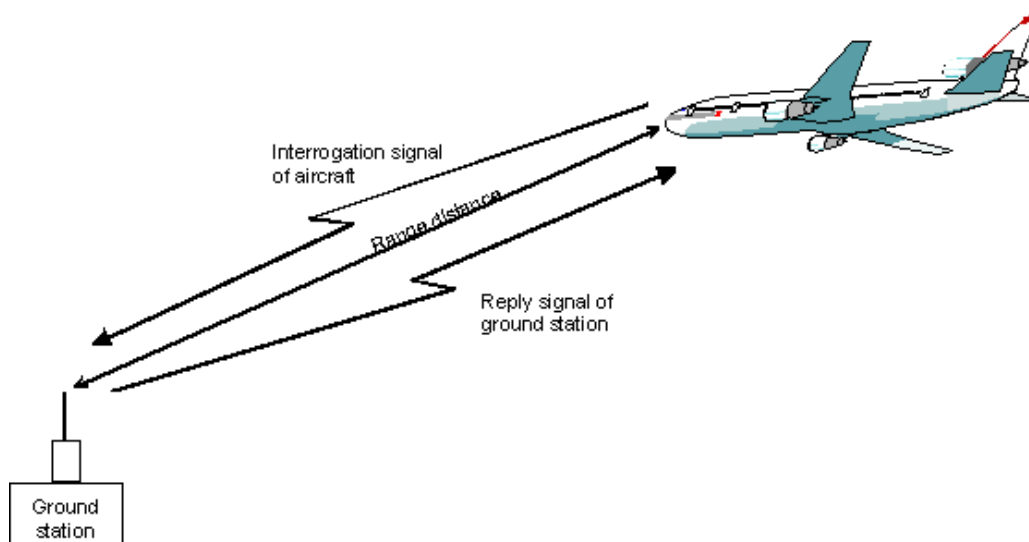

The DME channels are paired with the VOR frequencies, they are in the range between 1025 to 1150 MHz for the interrogator and 962 and 1213 MHz for the transponder. The spacing for all channels is 1 MHz. X and Y channels differ in the spacing between the two pulses of the pulse pair and in the delay for the reply pulse.

The interrogator transmits a stream of pulse pairs with fixed duration and spacing. The ground based transponder receives the pulse train and re-transmits them after a defined delay on a frequency which is +/-63MHz from the interrogation frequency. The airborne interrogator identifies its own stream of pulses and measures the time between the start of interrogation and response from the ground transponder in order to evaluate the slant

distance. The distance is given in nautic miles (nm). 1 nm is 1852.01 meters and corresponds to a run time of 12.359 us.

Two different modes are offered for the DME test signal:

- DME Interrogation
pulse stream from the interrogator, X or Y channel (simulation of aircraft interrogator)
- DME Reply
reply pulses from the transponder + optional ID signal, X or Y channel (simulation of ground station)

In addition a single test pulse can be generated.

The following graph shows the timing of the pulse pairs (slant range distance = 0 nm).

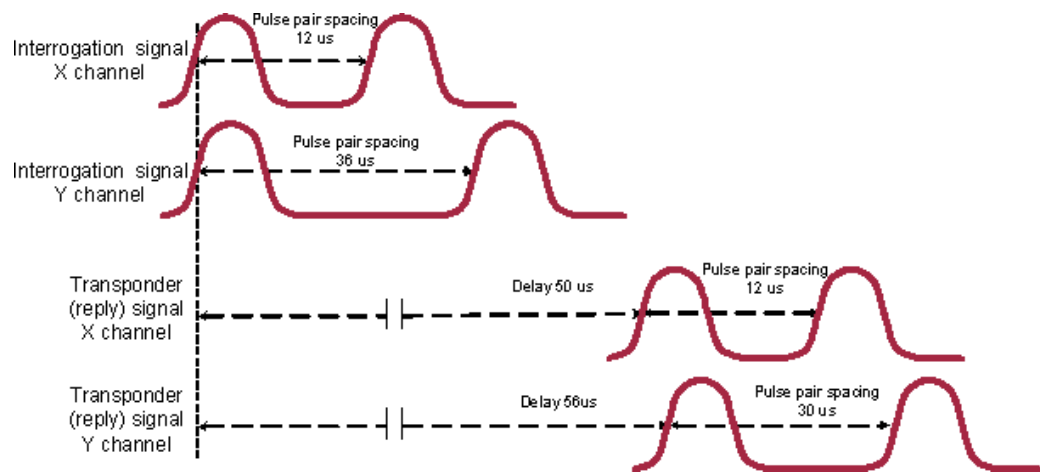
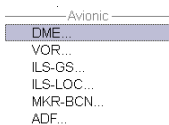

Fig. 5-8: Timing of the pulse pairs (slant range distance = 0 nm)

5.4.7.1 DME Modulation Settings

To access the "DME modulation" dialog, select "Modulation > Configure > DME" use the MENU key under "Modulation".



In the upper section of the dialog, the channel, pulse pair and trigger parameters are set. The lower section contains the parameters for setting the modulation. Reply response measurement is enabled using a R&S NRP-Z81 power sensor.

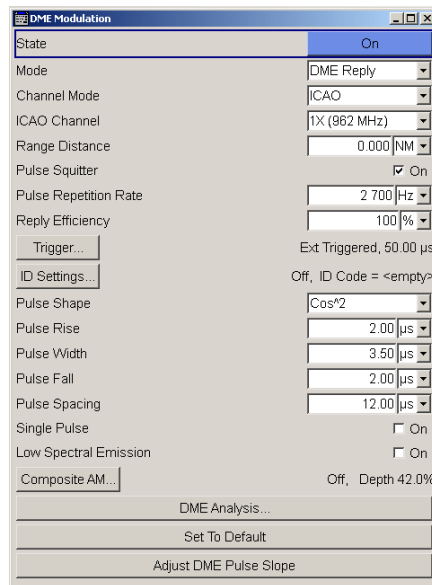

State - DME Modulation

Activates DME modulation

Note: Modulations PULSE, VOR, ILS-GS, ILS-LOC, MKR-BCN, ADF, AM, and internal FM/PhiM are automatically switched off when DME modulation is activated. Also, the pulse generator is automatically deactivated.

The DME modulation signal can be output at the LF connector.

SCPI command:

[:SOURce] :DME :STATe on page 490

Mode - DME Modulation

Selects the DME modulation mode. The mode determines the signal type that is simulated. The exact timing of the signal for each mode is determined by the selected channel (X or Y, see below).

The timing and shape of the pulses can be freely selected. By default these values are set according to the standard.

"DME Interrogation CH X/Y" The interrogation signal of the airborne transmitter is simulated. The following graph shows the interrogation signal of channel X.

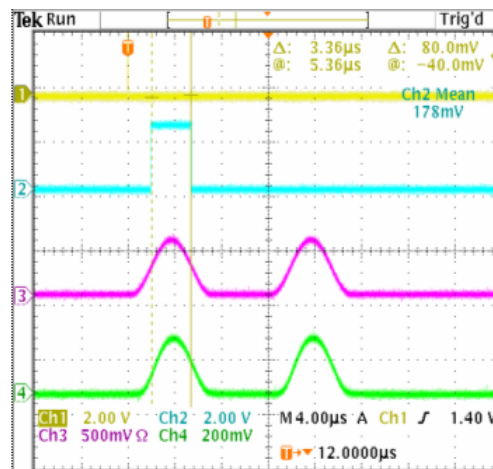

Fig. 5-9: DME Interrogation CH X (Trigger = Auto)

- 1 = SYNC signal (pulse width 50ns)
- 2 = VIDEO signal (active with 50 % pulse width of first DME pulse)
- 3 = LF Output signal (DME modulation signal)
- 4 = RF Output signal (measured with external detector)

"DME Reply
CH X/Y"

The reply signal of the ground based transponder is simulated. The trigger is automatically set to external and the default trigger delay either to 50 us (channel X) or 56 us (channel Y) depending on the selected channel. The trigger signal is input via the PULSE EXT connector. The interval between the pulse pairs can be set to a fixed value (repetition rate) or to random generation (pulse squitter). The following graph shows the reply signal of channel X (Trigger = External). In case of a trigger event, the reply pulse pair is generated after the set trigger delay.

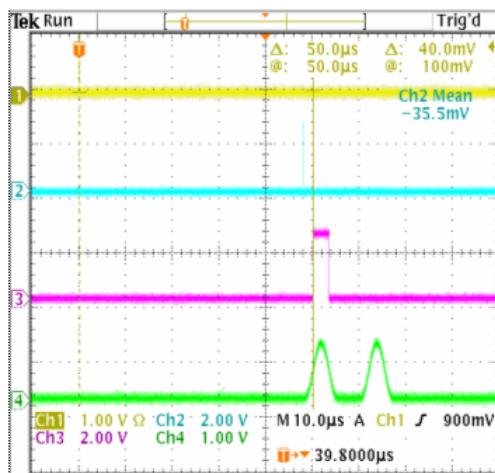

Fig. 5-10: DME Reply CH X (Trigger = External)

- 1 = external TRIGGER signal (T: pulse width 50ns)
- 2 = SYNC signal (pulse width 50ns)
- 3 = VIDEO signal with a delay of 50 us between external trigger and Video signal (= range distance of 0 nm) (active with 50 % pulse width of first DME pulse)
- 4 = LF Output signal (DME modulation signal)

SCPI command:

[:SOURce] :DME:MODE on page 486

Channel Mode - DME Modulation

Selects the channel that is simulated.

Standard compliant X and Y channels differ in the spacing between the two pulses of the pulse pair and the delay of the ground station (see table below). ICAO indicates the ICAO channel parameter below for selecting the ICAO channel.

Channel	Pulse spacing interrogation mode	Pulse spacing reply mode	Reply delay 1st pulse	Reply delay 2nd pulse
X	12 us	12 us	50 us	50 us
Y	36 us	30 us	56 us	50 us

SCPI command:

[:SOURce] :DME:CSUffix on page 479

ICAO Channel - DME Modulation

Selects the ICAO channel, i.e., the DME transmitting frequency. The RF frequency is set to the value selected here.

The individual values in the table are:

- **Ch. No.** = ICAO channel number
- **VOR Freq.** = VOR interrogation frequency (MHz)
- **DME Interrog. Freq.** = DME interrogation frequency (MHz)
- **DME Reply Freq.** = DME reply frequency (MHz)

Table 5-6: Standardized DME transmitting frequencies (MHz) and the associated ICAO channels for interrogation and reply

Ch. No.	VOR Freq.	DME Interrog. Freq.	DME Reply Freq.	Ch. No.	VOR Freq.	DME Interrog. Freq.	DME Reply Freq.	Ch. No.	VOR Freq.	DME Interrog. Freq.	DME Reply Freq.
1X		1025	962	43X	110.60	1067	1004	85X	113.80	1109	1172
1Y		1025	1088	43Y	110.65	1067	1130	85Y	113.85	1109	1046
2X		1026	963	44X	110.70	1068	1005	86X	113.90	1110	1173
2Y		1026	1089	44Y	110.75	1068	1131	86Y	113.95	1110	1047
3X		1027	964	45X	110.80	1069	1106	87X	114.00	1111	1174
3Y		1027	1090	45Y	110.85	1069	1132	87Y	114.05	1111	1048
4X		1028	965	46X	110.90	1070	1007	88X	114.10	1112	1175
4Y		1028	1091	46Y	110.95	1070	1133	88Y	114.15	1112	1049
5X		1029	966	47X	111.00	1071	1008	89X	114.20	1113	1176
5Y		1029	1092	47Y	111.05	1071	1134	89Y	114.25	1113	1050
6X		1030	967	48X	111.10	1072	1009	90X	114.30	1114	1177
6Y		1030	1093	48Y	111.15	1072	1135	90Y	114.35	1114	1051
7X		1031	968	49X	111.20	1073	1010	91X	114.40	1115	1178
7Y		1031	1094	49Y	111.25	1073	1136	91Y	114.45	1115	1052
8X		1032	969	50X	111.30	1074	1011	92X	114.50	1116	1179
8Y		1032	1095	50Y	111.35	1074	1137	92Y	114.55	1116	1053
9X		1033	970	51X	111.40	1075	1012	93X	114.60	1117	1180
9Y		1033	1096	51Y	111.45	1075	1138	93Y	114.65	1117	1054
10X		1034	971	52X	111.50	1076	1013	94X	114.70	1118	1181
10Y		1034	1097	52Y	111.55	1076	1139	94Y	114.75	1118	1055
11X		1035	972	53X	111.60	1077	1014	95X	114.80	1119	1182
11Y		1035	1098	53Y	111.65	1077	1140	95Y	114.85	1119	1056
12X		1036	973	54X	111.70	1078	1015	96X	114.90	1120	1183
12Y		1036	1099	54Y	111.75	1078	1141	96Y	114.95	1120	1057
13X		1037	974	55X	111.80	1079	1016	97X	115.00	1121	1184
13Y		1037	1100	55Y	111.85	1079	1142	97Y	115.05	1121	1058
14X		1038	975	56X	111.90	1080	1017	98X	115.10	1122	1185
14Y		1038	1101	56Y	111.95	1080	1143	98Y	115.15	1122	1059

Ch. No.	VOR Freq.	DME Interrog. Freq.	DME Reply Freq.	Ch. No.	VOR Freq.	DME Interrog. Freq.	DME Reply Freq.	Ch. No.	VOR Freq.	DME Interrog. Freq.	DME Reply Freq.
15X		1039	976	57X	112.00	1081	1018	99X	115.20	1123	1186
15Y		1039	1102	57Y	112.05	1081	1144	99Y	115.25	1123	1060
16X		1040	977	58X	112.10	1082	1019	100X	115.30	1124	1187
16Y		1040	1103	58Y	112.15	1082	1145	100Y	115.35	1124	1061
17X	108.00	1041	978	59X	112.20	1083	1020	101X	115.40	1125	1188
17Y	108.05	1041	1104	59Y	112.25	1083	1146	101Y	115.45	1125	1062
18X	108.10	1042	979	60X		1084	1021	102X	115.50	1126	1189
18Y	108.15	1042	1105	60Y		1084	1147	102Y	115.55	1126	1063
19X	108.20	1043	980	61X		1085	1022	103X	115.60	1127	1190
19Y	108.25	1043	1106	61Y		1085	1148	103Y	115.65	1127	1064
20X	108.30	1044	981	62X		1086	1023	104X	115.70	1128	1191
20Y	108.35	1044	1107	62Y		1086	1149	104Y	115.75	1128	1065
21X	108.40	1045	982	63X		1087	1024	105X	115.80	1129	1192
21Y	108.45	1045	1108	63Y		1087	1150	105Y	115.85	1129	1066
22X	108.50	1046	983	64X		1088	1151	106X	115.90	1130	1193
22Y	108.55	1046	1109	64Y		1088	1025	106Y	115.95	1130	1067
23X	108.60	1047	984	65X		1089	1152	107X	116.00	1131	1194
23Y	108.65	1047	1110	65Y		1089	1026	107Y	116.05	1131	1068
24X	108.70	1048	985	66X		1090	1153	108X	116.10	1132	1195
24Y	108.75	1048	1111	66Y		1090	1027	108Y	116.15	1132	1069
25X	108.80	1049	986	67X		1091	1154	109X	116.20	1133	1196
25Y	108.85	1049	1112	67Y		1091	1028	109Y	116.25	1133	1070
26X	108.90	1050	987	68X		1092	1155	110X	116.30	1134	1197
26Y	108.95	1050	1113	68Y		1092	1029	110Y	116.35	1134	1071
27X	109.00	1051	988	69X		1093	1156	111X	116.40	1135	1198
27Y	109.05	1051	1114	69Y		1093	1030	111Y	116.45	1135	1072
28X	109.10	1052	989	70X	112.30	1094	1157	112X	116.50	1136	1199
28Y	109.15	1052	1115	70Y	112.35	1094	1031	112Y	116.55	1136	1073
29X	109.20	1053	990	71X	112.40	1095	1158	113X	116.60	1137	1200
29Y	109.25	1053	1116	71Y	112.45	1095	1032	113Y	116.65	1137	1074
30X	109.30	1054	991	72X	112.50	1096	1159	114X	116.70	1138	1201
30Y	109.35	1054	1117	72Y	112.55	1096	1033	114Y	116.75	1138	1075
31X	109.40	1055	992	73X	112.60	1097	1160	115X	116.80	1139	1202
31Y	109.45	1055	1118	73Y	112.65	1097	1034	115Y	116.85	1139	1076
32X	109.50	1056	993	74X	112.70	1098	1161	116X	116.90	1140	1203
32Y	109.55	1056	1119	74Y	112.75	1098	1035	116Y	116.95	1140	1077

Ch. No.	VOR Freq.	DME Interrog. Freq.	DME Reply Freq.	Ch. No.	VOR Freq.	DME Interrog. Freq.	DME Reply Freq.	Ch. No.	VOR Freq.	DME Interrog. Freq.	DME Reply Freq.
33X	109.60	1057	994	75X	112.80	1099	1162	117X	117.00	1141	1204
33Y	109.65	1057	1120	75Y	112.85	1099	1036	117Y	117.05	1141	1078
34X	109.70	1058	995	76X	112.90	1100	1163	118X	117.10	1142	1205
34Y	109.75	1058	1121	76Y	112.95	1100	1037	118Y	117.15	1142	1079
35X	109.80	1059	996	77X	113.00	1101	1164	119X	117.20	1143	1206
35Y	109.85	1059	1122	77Y	113.05	1101	1038	119Y	117.25	1143	1080
36X	109.90	1060	997	78X	113.10	1102	1165	120X	117.30	1144	1207
36Y	109.95	1060	1123	78Y	113.15	1102	1039	120Y	117.35	1144	1081
37X	110.00	1061	998	79X	113.20	1103	1166	121X	117.40	1145	1208
37Y	110.05	1061	1124	79Y	113.25	1103	1040	121Y	117.45	1145	1082
38X	110.10	1062	999	80X	113.30	1104	1167	122X	117.50	1146	1209
38Y	110.15	1062	1125	80Y	113.35	1104	1041	122Y	117.55	1146	1083
39X	110.20	1063	1000	81X	113.40	1105	1168	123X	117.60	1147	1210
39Y	110.25	1063	1126	81Y	113.45	1105	1042	123Y	117.65	1147	1084
40X	110.30	1064	1001	82X	113.50	1106	1169	124X	117.70	1148	1211
40Y	110.35	1064	1127	82Y	113.55	1106	1043	124Y	117.75	1148	1085
41X	110.40	1065	1002	83X	113.60	1107	1170	125X	117.80	1149	1212
41Y	110.45	1065	1128	83Y	113.65	1107	1044	125Y	117.85	1149	1086
42X	110.50	1066	1003	84X	113.70	1108	1171	126X	117.90	1150	1213
42Y	110.55	1066	1129	84Y	113.75	1108	1045	126Y	117.95	1150	1087

SCPI command:

[\[:SOURCE\]:DME:ICAO:CHANNEL](#) on page 479

Range Distance - DME Modulation

(Reply mode only)

Sets the simulated distance between interrogator and transponder for reply mode. The distance is given in nautic miles (nm). 1 nm is 1852.01 meters and corresponds to a run time of 12.359 us.

The range distance and the external trigger delay are interdependent according to:

"Range Distance" = ("Trigger Delay" – X/Y mode delay)/12.359 μs/nm, where

X mode delay = 50 us, Y mode delay = 56 us

Changing one value automatically changes the other value.

SCPI command:

[\[:SOURCE\]:DME:RDISTANCE](#) on page 488

Pulse Squitter - DME Modulation

The average repetition rate is 2700 pp/s. The pulse spacing is distributed randomly in the range of 60 us to about 1500 us according to EUROCAE EN-54 6.2.12.

The squitter pulses are constantly sent by the ground station in order to ensure proper operation and in order to ease synchronization of the aircraft interrogator to the ground station.

SCPI command:

`[:SOURce] :DME:SQUitter` on page 489

Pulse Repetition Rate - DME Modulation

- In "Interrogation mode"
Sets the pulse repetition rate for trigger setting "Auto" or "Ext Gated".
- In "Reply Mode"
Indicates the mean pulse repetition rate in squitter mode.

SCPI command:

`[:SOURce] :DME:RATE` on page 487

Reply Efficiency - DME Modulation

(for Reply mode on only)

Sets the relation between reply pulse pairs and received trigger signals, e.g. with a set efficiency of 50% only every second trigger event leads to the generation of a reply pulse pair.

SCPI command:

`[:SOURce] :DME:EFFiciency` on page 480

Trigger - DME Modulation

The button opens the menu for setting the trigger (see [chapter 5.4.7.2, "Trigger Settings for DME"](#), on page 246).

ID Settings - DME Modulation

(Reply mode only)

Opens the menu for setting the DME ID signal (see [chapter 5.4.7.3, "ID Settings for DME Reply Mode"](#), on page 248).

Pulse Shape - DME Modulation

Selects the pulse shape.

"Cos^2" The falling and the rising edge of the pulse are cos^2 shaped.

"Cos Cos^2" The rising edge is cos shaped and the falling edge is cos^2 shaped.

"Linear" The falling and the rising edge of the pulse are shaped linear.

SCPI command:

`[:SOURce] :DME:SHAPE` on page 489

Pulse Rise - DME Modulation

Sets the rise time of the pulse (10% to 90% of peak voltage).

SCPI command:

`[:SOURce] :DME:RISE` on page 488

Pulse Width - DME Modulation

Sets the pulse width (50% to 50% of peak voltage).

SCPI command:

[\[:SOURce\]:DME:WIDTh](#) on page 495

Pulse Fall - DME Modulation

Sets the fall time of the pulse (90% to 10% of peak voltage).

SCPI command:

[\[:SOURce\]:DME:FALL](#) on page 481

Pulse Spacing - DME Modulation

Sets the spacing between the first and second pulse of a pulse pair (time between half-voltage points on the leading edge of each pulse).

SCPI command:

[\[:SOURce\]:DME:PPS](#) on page 487

Single Pulse - DME Modulation

Activates generation of a single test pulse.

SCPI command:

[\[:SOURce\]:DME:SINGLE](#) on page 489

Low Spectral Emission - DME Modulation

Activates the generation of a DME signal with higher spectral purity but less dynamic compared to the default mode. The ON/OFF ratio of the pulses is reduced from typ. >100 dB to typ. 35 dB.

SCPI command:

[\[:SOURce\]:DME:LOWemission](#) on page 486

Composite AM... - DME Modulation

(Reply mode only)

Opens the menu for defining the two-tone signals that can be additionally superimposed on the pulses (see [chapter 5.4.7.4, "DME Composite AM"](#), on page 251).

DME Analysis - DME Modulation

Only if a R&S NRP-Z81 power sensor is connected to the R&S SMA sensor connector.

Opens the menu for setting the DME Analysis (see [chapter 5.4.7.5, "DME Analysis"](#), on page 253).

Set To Default - DME Modulation

Sets a default DME signal (interrogation mode channel X).

Selects the default settings for the pulse parameters according to standard (EUROCAE ED57/ED54 and ICAO ANNEX 10 to the convention of international civil aviation).

The state of the modulation is not influenced by this button.

SCPI command:

[\[:SOURce\]:DME:PRESet](#) on page 487

Adjust DME Pulse Slope

Activates internal adjustment of the DME pulse slope for best linearity.

SCPI command:

[:CALibration:DME\[:MEASure\]?](#) on page 361

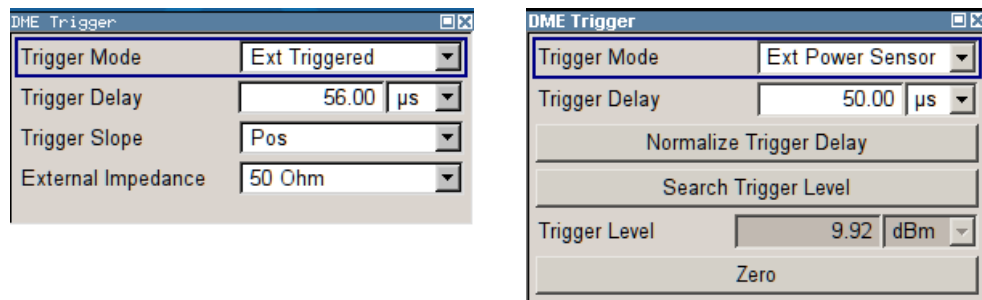
5.4.7.2 Trigger Settings for DME**Trigger Mode - DME Modulation**

Selects the trigger mode for DME modulation signals. For "Reply Mode" only external trigger is possible

- "Auto" The DME modulation signals are generated continuously.
- "Ext Triggered" The DME modulation signals are triggered by an external trigger event. The trigger signal is supplied via the PULSE EXT connector.
- "Ext Gated" The DME modulation signals are gated by an external gate signal. The signal is supplied via the PULSE EXT connector.
- "Ext Power Sensor" Sensor R&S NRP-Z81 provides the trigger signal. An external DME interrogation signal is feed into a sensor. The 50% voltage point of this signal is used by the R&S NRP-Z81 sensor to generate the trigger for the R&S SMA. The R&S SMA simulates the ground station ("Reply Mode") and sends the reply signal after the set trigger delay.

SCPI command:

[\[:SOURce\]:DME:TRIGger](#) on page 492

Trigger Delay - DME Modulation

(External Trigger and Ext Power Sensor only)

Sets the delay between the external trigger and the first DME output pulse (50% voltage point of first pulse). For DME Reply mode this simulates the defined delay of the DME transponder and twice the run time of the signal (from interrogator to transponder and back). The delay is a measure of the range distance, thus, the two values are interdependent according to:

Delay = X/Y mode delay + range distance * 12.359 nm/μs, where

X mode delay = 50 us, Y mode delay = 56 us

Changing one value automatically changes the other value.

SCPI command:

[\[:SOURce\]:DME:TRIGger:DELay](#) on page 493

Trigger Slope - DME Modulation

(External Trigger only)

Sets the polarity of the active slope of an applied trigger at the PULSE EXT connector.

"Positive" The DME modulation signals are triggered on the positive slope of the external trigger signal.

"Negative" The DME modulation signals are triggered on the negative slope of the external trigger signal.

SCPI command:

[\[:SOURce\]:DME:TRIGger:SLOPe](#) on page 495

Gate Input Polarity - DME Modulation

(External Gate only)

Sets the polarity of the active slope of an applied trigger at the PULSE EXT connector.

"Normal" The DME modulation signal is generated while the gate signal is high.

"Inverse" The DME modulation signal is generated while the gate signal is low.

SCPI command:

[\[:SOURce\]:DME:TRIGger:GPOLarity](#) on page 494

External Impedance - DME Modulation

(External Trigger or Gate only)

Selects the input impedance for the external trigger and gate signal input PULSE EXT (10 kOhm or 50 Ohm).

SCPI command:

[\[:SOURce\]:DME:TRIGger:IMPedance](#) on page 494

Normalize Trigger Delay - DME Modulation

(External Power Sensor only)

Performs a normalization of the test setup. The delay due to the R&S NRP-Z81 sensor is measured and subsequently considered in the trigger delay.

For normalization, the Sensor is connected directly to the RF output of the R&S SMA. "Normalize Trigger Delay" determines the delay between RF input and trigger output of the sensor. This value is sensor specific and is stored on the R&S SMA. The value is valid as long as the same sensor is used.

SCPI command:

[\[:SOURce\]:DME:TRIGger:DELay:NORMAlize?](#) on page 494

Search Trigger Level - DME Modulation

(External Power Sensor only)

Determines the trigger level = 50% voltage point of first pulse of the external DME interrogation signal.

After connecting the R&S NRP-Z81 sensor to the external interrogation signal source, "Search Trigger Level" determines the trigger point. The search function has to be executed with each change of the level of the external DME signal.

SCPI command:

[\[:SOURCE\]:DME:ANALYSIS:TRIGGER:SEARCH?](#) on page 478

Trigger Level - DME Modulation

(External Power Sensor only)

Indicates the trigger level, e.g. 9.92 dBm for an external signal with a peak level of 15.94 dBm.

SCPI command:

n.a.

Zero - Power Sensors

(External Power Sensor only)

Activates the auto zero function.

Zeroing calibrates the external power sensor by adjusting its reading at zero signal power. For this purpose, the RF power source must be switched off or disconnected from the sensor (see tips below). R&S power sensors automatically detect the presence of any significant input power. This aborts zeroing and generates an error message. Zeroing can take a few seconds, depending on the sensor model; refer to the documentation of your external power sensor for more information.

Tips for zeroing

Zeroing should be performed:

- During warm-up after switching on or connecting the instrument
- After a substantial change of the ambient temperature
- After fastening the power sensor module to an RF connector at high temperature
- After several hours of operation
- When very low-power signals are to be measured, e.g. less than 10 dB above the lower measurement limit.
- Switch off the RF power source for zeroing; do not disconnect it from the power sensor. In this way you will maintain the thermal equilibrium, and zeroing will also compensate for the noise superimposed on the measured signal (e.g. from a broadband amplifier).

SCPI command:

[SENSe<ch>\[:POWER\]:ZERO](#) on page 438

5.4.7.3 ID Settings for DME Reply Mode

In the "DME ID" submenu the identification sequence for the reply signal is defined. Each airport identifies itself with a three letter code, for example 'MUC' for the Munich airport. This information is transmitted in morse code. The transmission of the identification sequence can be switched off.

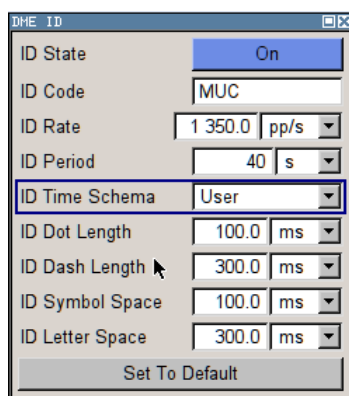

ID State - DME Modulation

(Reply mode only)

Switches on/off the generation of the identification sequence (ID signal) of the ground station. The ID signal consists of a series of pulse pairs transmitted at a rate of 1350 Hz.

The transmission of the ground signal is interrupted every 40 seconds (ID period) and one ID sequence is transmitted instead. The "key down time" of the ground signal corresponds to the period of transmission for a dot or dash in the Morse code ID sequence (e.g. 100ms for a dot). During the key down times reply pulses are not transmitted, however, they are transmitted between the key down times.

SCPI command:

[\[:SOURce\]:DME:ID\[:STATe\]](#) on page 484

ID Code - DME Modulation

(Reply mode only)

Enters the coding of the ID signal by the international short name of the airport (e.g. MUC for the Munich airport). (ID signal).

The ID tone is sent according to the selected code (see table of Morse below [table 5-7](#)). The length of the morse code can be varied. For selection standard time scheme, the selected dot length determines the setting of all other length parameters of the Morse code (dash length, symbol space and letter space). For selection user time scheme, all length parameters of the code can be set independently.

Table 5-7: Morse Code

Letter	Morse Code	Letter	Morse Code
A	. -	N	- .
B	- . . .	O	- - -
C	- . - .	P	. - - .
D	- . .	Q	- - . -
E	.	R	. - .
F	. . - .	S	. . .
G	- - .	T	-
H	U	. . -

Letter	Morse Code	Letter	Morse Code
I	..	V	...-
J	.----	W	.-.
K	-.-	X	-...-
L	.-...	Y	-.-..
M	--	Z	--...

Note:

The following values are default values:

- A dot (.) has a tone duration of 100 ms
- A dash (-) has a tone duration of 300ms
- The time between two tones is 100ms
- The time between two letters is 300ms

Example:

ID code = MUC

The word length =

$$300+100+300+300+100+100+100+100+300+300+300+100+100+100+300+100+100 = 3100 \text{ ms}$$

SCPI command:

[\[:SOURce\]:DME:ID:CODE](#) on page 481

ID Rate - DME Modulation

(Reply mode only)

Enters the pulse repetition rate of the ID sequence.

SCPI command:

[\[:SOURce\]:DME:ID:RATE](#) on page 484

ID Period - DME Modulation

(Reply mode only)

Enters the period of the ID sequence by means of seconds.

SCPI command:

[\[:SOURce\]:DME:ID:PERiod](#) on page 483

ID Time Schema - DME Modulation

(Reply mode only)

Selects if the set dot length determines the dash length (= three times the dot length) (setting Standard) or if all length parameters can be set independently (setting User). (ID signal).

SCPI command:

[\[:SOURce\]:DME:ID:TSCHEMA](#) on page 485

ID Dot Length - DME Modulation

(Reply mode only)

Enters the length of a morse dot by means of seconds. The length of the dash (3xdot), space (=dot) and letter space (=3xdot) is also determined by this entry if standard time scheme is selected.

SCPI command:

[\[:SOURce\]:DME:ID:DOT](#) on page 482

ID Dash Length - DME Modulation

(Reply mode and user time schema only)

Enters the length of a morse dash by means of seconds.

SCPI command:

[\[:SOURce\]:DME:ID:DASH](#) on page 481

ID Symbol Space - DME Modulation

(Reply mode and user time schema only)

Enters the length of a symbol space by means of seconds.

SCPI command:

[\[:SOURce\]:DME:ID:SYMBOL](#) on page 485

ID Letter Space - DME Modulation

(Reply mode and user time schema only)

Enters the length of a letter space by means of seconds.

SCPI command:

[\[:SOURce\]:DME:ID:LETTER](#) on page 483

Set To Default ID - DME Modulation

Selects the default settings for the ID signal.

SCPI command:

[\[:SOURce\]:DME:ID:PRESet](#) on page 484

5.4.7.4 DME Composite AM

The "DME Composite AM" menu provides the settings for a two-tone signal that can be superimposed on the DME pulses by means of amplitude modulation. This feature enables the user simulate the variation of the DME pulse amplitude for DME receiver testing.

The following example shows a DME signal with a superimposed two-tone signal:

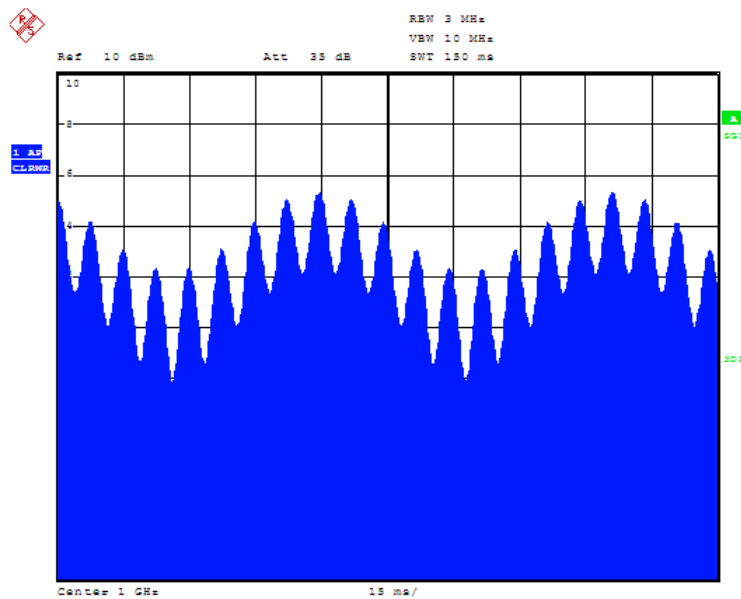
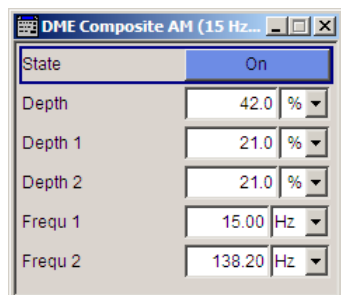

Fig. 5-11: Measurement of RF envelope with DME interrogations at 6000 pp/s

DME Composite AM Menu

DME defines frequency and depth of the two-tone signal, which is superimposed to the pulse signal by means of amplitude modulation.



Composite AM State - DME Modulation

Activates/deactivates the two-tone signal.

SCPI command:

[\[:SOURce\]:DME:TACan:STATe](#) on page 492

Composite AM Depth - DME Modulation

Sets the modulation depth in per cent.

Note: Observe that this value is valid for both signals and the sum modulation depth is determined by doubling the set modulation depth. This results in overmodulation if the maximal value for modulation depth is exceeded (see data sheet).

SCPI command:

[\[:SOURce\]:DME:TACan:DEPTH](#) on page 490

Composite AM Depth 1/2 - DME Modulation

Determines the modulation depth in per cent for one component of the two-tone signal.

SCPI command:

[\[:SOURce\]:DME:TACan:INTernal<ch>:DEPTH](#) on page 491

Composite AM Frequency 1/2 - DME Modulation

Sets the individual frequencies of the two-tone signal.

SCPI command:

[\[:SOURce\]:DME:TACan<ch>:FREQuency](#) on page 491

5.4.7.5 DME Analysis

The DME analysis uses a R&S NRP-Z81 Power Sensor to measure the reply delay, the average peak power, the efficiency and the pulse repetition rate of the ground station transponder. The interrogation signal is simulated by the R&S SMA and transmitted to the transponder. The reply signal of the transponder is measured using the power sensor and is analyzed by internal software routines in order to determine these parameters. The measurement values are indicated in the DME menu.

DME Analysis Dialog

To open the "DME Analysis" dialog, select "DME Analysis" in the "DME Modulation" dialog.

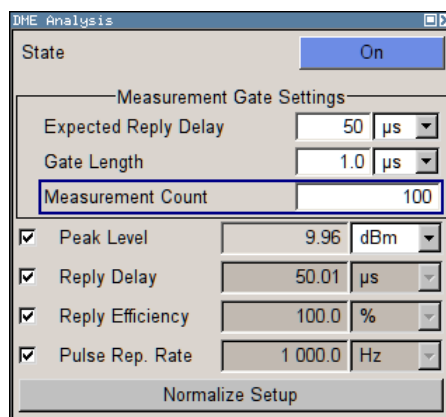
**DME Analysis State - DME Modulation**

Only if a R&S NRP-Z81 power sensor is connected to the R&S SMA sensor connector.

Activates the DME analysis. The R&S SMA generates interrogation pulse pairs and starts an internal counter for time measurement.

The measurement gate settings determine the measurement window (expected reply delay +/- gate length/2). Only reply pulses for which the 50% voltage point of the rising edge of the first pulse is within the measurement window are used to evaluate the delay time and reply efficiency. The delay measurement is averaged within the measurement cycle. The reply efficiency is calculated once for each measurement cycle.

Example:

The gate length is 1 μs and the expected reply delay is 50 μs . The measurement window lies in the range between 49.5 and 50.5 μs . Only pulse pairs are used for the measurement whose 50% voltage point of the rising edge of the first pulse is within this range.

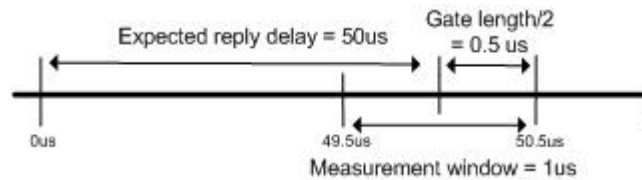

SCPI command:

[\[:SOURce\]:DME:ANALysis:STATe](#) on page 477

Expected Reply Delay - DME Modulation

Only if a R&S NRP-Z81 power sensor is connected to the R&S SMA sensor connector
Enters the expected reply delay.

SCPI command:

[\[:SOURce\]:DME:ANALysis:GATE:EDELay](#) on page 473

Gate Length - DME Modulation

Only if a R&S SMA NRP-Z81 power sensor is connected to the R&S SMA sensor connector.

Sets the gate length for the measurement window.

SCPI command:

[\[:SOURce\]:DME:ANALysis:GATE\[:LENGth\]](#) on page 473

Measurement Count - DME Modulation

Only if a R&S SMA NRP-Z81 power sensor is connected to the R&S SMA sensor connector

Sets the number of pulse pairs which are sent from the R&S SMA (= interrogator) to the ground station in one measurement cycle.

SCPI command:

[\[:SOURce\]:DME:ANALysis:GATE:COUNT](#) on page 472

Peak Level State - DME Modulation

Only if a R&S NRP-Z81 power sensor is connected to the R&S SMA sensor connector
Activates/deactivates the measurement of the average peak level of all valid pulse pairs in a measurement cycle.

SCPI command:

[\[:SOURce\]:DME:ANALysis:POWer:STATe](#) on page 475

Peak Level - DME Modulation

Only if a R&S NRP-Z81 power sensor is connected to the R&S SMA sensor connector.

Indicates the measured average peak level of all pulse pairs in a measurement cycle.

SCPI command:

[\[:SOURce\]:DME:ANALysis:POWer?](#) on page 474

Reply Delay Status- DME Modulation

Only if a R&S NRP-Z81 power sensor is connected to the R&S SMA sensor connector.

Activates/deactivates the measurement of the average reply delay of all valid pulse pairs in a measurement cycle.

SCPI command:

[\[:SOURce\]:DME:ANALysis:TIME:STATe](#) on page 478

Reply Delay - DME Modulation

Only if a R&S NRP-Z81 power sensor is connected to the R&S SMA sensor connector

Indicates the measured average reply delay of all valid pulse pairs in a measurement cycle. If there are no valid measurements available in the set measurement window 'invalid' is indicated.

SCPI command:

[\[:SOURce\]:DME:ANALysis:TIME?](#) on page 477

[\[:SOURce\]:DME:ANALysis:TIME:OK?](#) on page 478

Reply Efficiency State- DME Modulation

Only if a R&S NRP-Z81 power sensor is connected to the R&S SMA sensor connector.

Activates/deactivates the measurement of the reply efficiency in percent. The measurement is the ratio of the number of measured valid reply pulse pairs to transmitted pulse pairs in a measurement cycle.

SCPI command:

[\[:SOURce\]:DME:ANALysis:EFFiciency:STATe](#) on page 472

Reply Efficiency - DME Modulation

Only if a R&S NRP-Z81 power sensor is connected to the R&S SMA sensor connector.

Indicates the measured reply efficiency in percent. The measurement is the ratio of the number of measured valid reply pulse pairs to transmitted pulse pairs in a measurement cycle. If there are no valid measurements available in the set measurement window 'invalid' is indicated.

SCPI command:

[\[:SOURce\]:DME:ANALysis:EFFiciency?](#) on page 471

[\[:SOURce\]:DME:ANALysis:EFFiciency:OK?](#) on page 472

Pulse Repetition Frequency State - DME Modulation

Only if a R&S NRP-Z81 power sensor is connected to the R&S SMA sensor connector.

Activates/deactivates the measurement of the mean pulse repetition rate of the DME ground station. For this measurement all received pulses of the DME ground station are considered. The typical measurement time for this parameter is approx. 1 second.

This measurement and the measurement of the delay, efficiency and average peak power are performed alternately. Therefore, the speed of the pulse repetition measurement increases if all other measurements are deactivated.

SCPI command:

`[:SOURce] :DME:ANALysis:PRRate:STATE` on page 476

Pulse Repetition Frequency - DME Modulation

Only if a R&S NRP-Z81 power sensor is connected to the R&S SMA sensor connector.

Indicates the measured mean pulse repetition rate of the DME ground station.

If there are no valid measurements available in the set measurement window 'invalid' is indicated.

SCPI command:

`[:SOURce] :DME:ANALysis:PRRate?` on page 475

`[:SOURce] :DME:ANALysis:PRRate:OK?` on page 476

Normalize Setup - DME Modulation

Only if a R&S NRP-Z81 power sensor is connected to the R&S SMA sensor connector.

Performs a normalization of the test setup. The delay due to the test setup is measured and subsequently considered in the reply measurements.

SCPI command:

`[:SOURce] :DME:ANALysis:NORMalize?` on page 474

Test Setup for DME Analysis



See also Application Note 1GP74 "Test of DME/TACAN Transponders". The application note is available at the download area of the Rohde & Schwarz internet site (http://www2.rohde-schwarz.com/file/1GP74_1E.pdf).

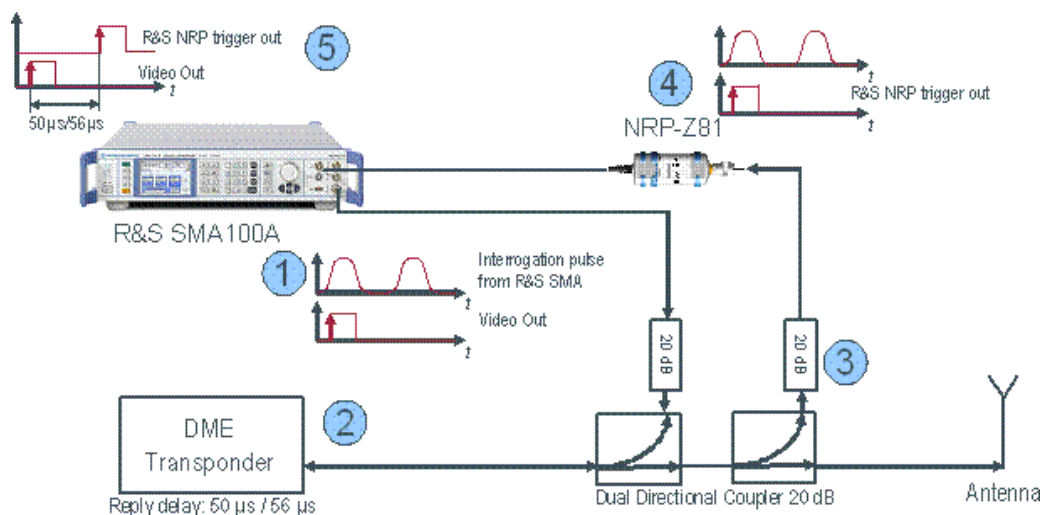

NOTICE**Possible damage to the power sensor**

High output power of the DME transponder (up to 1 kW) might destroy the power sensor. Therefore, the attenuator at the power sensor input must be selected in such a way, that the power applied to the power sensor is in the allowed range of the R&S NRP-Z81 before connecting the power sensor to the coupler.

Procedure for DME Reply Delay measurement

1. The R&S SMA generates interrogation pulse pairs and starts an internal counter for time measurement.
2. The interrogation pulse pair is received by the DME transponder, which should reply after a 50 or 56 microsecond delay (depending on the channel) with a reply pulse pair.
3. The transmitted power is coupled to the power sensor input.
4. The transmitted reply pulse pair is received by the R&S NRP-Z81 wideband power sensor, which triggers the R&S SMA to stop the time measurement. The R&S NRP-Z81 also measures the peak pulse power and sends this information to the R&S SMA.
5. The R&S SMA100A displays the peak pulse power of the reflected reply pulse pair, the reply delay of the DME transponder (ideally 50 or 56 microseconds) and the DME transponder efficiency (the number of response pulse pairs as a percentage of interrogation pulse pairs).

Finally, the reply delay value has to be corrected by adding twice the signal delay caused by the cable between coupler and antenna. The delay has to be added twofold because both, the delay for the received signal and the delay for the transmitted signal, have to be taken into account. The following equation provides a typical value for the twofold signal delay due to cable length:

$$\Delta t = \frac{2 \times l \times \sqrt{\epsilon_r}}{c}$$

, whereas l = cable length in meters,

ϵ_r = relative dielectric constant (e.g., 2.1 for teflon, 2.25 for polyethylene)

$c = 3 \times 10^8$ m/s

Optional normalization of the test setup removes additional delays that are due to the test setup.

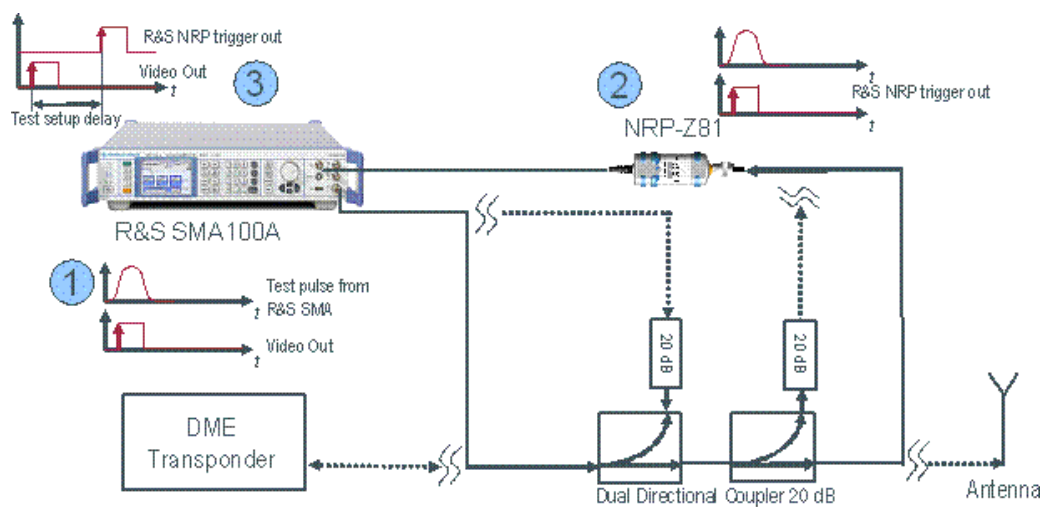

Procedure for Test Setup Normalization

1. The R&S SMA generates a test pulse for normalization and starts the counter for time measurement. The test pulse is transmitted to the R&S NRP-Z81 power sensor via the dual directional coupler, the connections to the DME transponder and the antenna are interrupted.
2. The test pulse is received by the R&S NRP-Z81 wideband power sensor, which triggers the R&S SMA to stop the time measurement.
3. The R&S SMA registers the test setup delay and considers it in a subsequent DME analysis measurement. The correction value is stored on the internal flash disk and therefore available also after a restart of the signal generator.

5.4.8 VOR Modulation

VOR modulation (VHF **O**mnidirectional **R**ange) is available for the basic unit (R&S SMA + frequency option R&S SMA-B10x) equipped with option R&S SMA-K25.

VOR systems provide directional information for air planes in flight. The VOR stations transmit a carrier which is modulated with two separate 30 Hz modulations. One of the 30Hz signals (Reference signal) remains in the same phase at all reception positions around the VOR station. The other 30Hz signal received (Variable signal) will differ in phase by exactly the angular displacement of the receiver around the VOR from the Zero radial. The aircraft receiver demodulates the two 30Hz signals and compares their phase difference.

Four different modes are offered for the VOR test signal:

- Norm
VOR modulation + optional COM/ID tone
- VAR
Amplitude modulation of the output signal with the 30 Hz signal content of the VOR signal.
- Subcarrier

Amplitude modulation of the output signal with the unmodulated 9960 Hz FM carrier of the VOR signal

- **Subcarrier + FM**
Amplitude modulation of the output signal with the frequency-modulated 9960 Hz FM carrier of the VOR signal

An external signal can be added to the internal signal (EXT AM = EXT (MOD AM)). The external signal is input via the AM EXT connector.

The VOR signal is output at the LF OUT connector at the front of the instrument.

5.4.8.1 VOR Modulation Settings

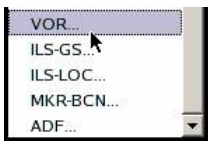

The "VOR Modulation" dialog is opened in the "Mod" function block or using the MENU key under "Mod".

In the upper section, the modulation source is selected and the modulation switched on. The configuration of the selected external and/or internal modulation source is performed in the lower section of the dialog.

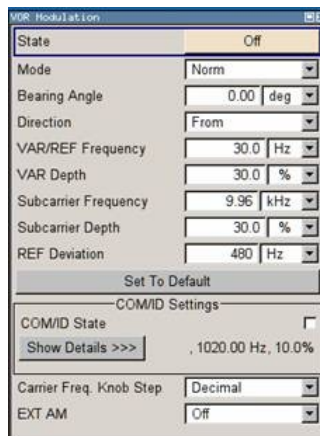

State - VOR Modulation

Activates VOR modulation.

Activation of VOR modulation deactivates AM, ILS, Marker Beacon and ADF modulation.

Source selection is disabled in the "LF Output" menu:



SCPI command:

[:SOURce] :VOR:STATe on page 612

Mode - VOR Modulation

Selects the operating mode for the VOR modulation signal.

"Norm" VOR modulation is active.

"VAR"	Amplitude modulation of the output signal with the VAR signal component (30Hz signal content) of the VOR signal. The modulation depth of the 30 Hz signal corresponds to the value set under "Var Depth".
"Subcarrier"	Amplitude modulation of the output signal with the unmodulated FM carrier (9960Hz) of the VOR signal. The modulation depth corresponds to the value set under "Subcarrier Depth".
"Subcarrier + FM"	Amplitude modulation of the output signal with the frequency-modulated FM carrier (9960Hz) of the VOR signal. The frequency deviation corresponds to the value set under "Ref Deviation", the modulation depth corresponds to the value set under "Subcarrier Depth".

SCPI command:

[\[:SOURce\]:VOR:MODE](#) on page 610

Bearing Angle - VOR Modulation

Enters the phase angle between the 30Hz VAR signal and the 30Hz reference signal. The orientation of the angle depends on the selected direction.

SCPI command:

[\[:SOURce\]:VOR\[:BANGLE\]](#) on page 614

Direction - VOR Modulation

Enters the reference position of the phase information.

"From"	Selection of the beacon as a reference position. The angle set under "Bearing Angle" corresponds to the angle between the geographic north and the connection line from beacon to airplane.
"To"	Selection of the airplane position as a reference position. The angle set under "Bearing Angle" corresponds to the angle between the geographic north and the connection line from airplane to beacon.

SCPI command:

[\[:SOURce\]:VOR\[:BANGLE\]:DIRection](#) on page 614

VAR/REF Frequency - VOR Modulation

Enters the frequency of the VAR signal and the REF signal. As the two signals must have the same frequency, the setting is valid for both signals.

SCPI command:

[\[:SOURce\]:VOR:VAR:FREQuency](#) on page 613

VAR Depth - VOR Modulation

Enters the AM modulation depth of the 30Hz VAR signal. The sum of subcarrier depth, VAR depth and COM/ID and must be smaller than 100 PCT.

SCPI command:

[\[:SOURce\]:VOR:VAR\[:DEPTH\]](#) on page 614

Subcarrier Frequency - VOR Modulation

Enters the frequency of the FM carrier.

SCPI command:

[\[:SOURce\]:VOR:SUBCarrier\[:FREQuency\]](#) on page 613

Subcarrier Depth - VOR Modulation

Enters the AM modulation depth of the FM carrier. The sum of subcarrier depth, VAR depth and COM/ID depth must be smaller than 100 PCT.

SCPI command:

[\[:SOURce\]:VOR:SUBCarrier:DEPTh](#) on page 613

REF Deviation - VOR Modulation

Enters the frequency deviation of the REF signal on the FM carrier.

Remote-control command: SOUR:VOR:REF:DEV 480

SCPI command:

[\[:SOURce\]:VOR:REFerence\[:DEViation\]](#) on page 611

Set to Default - VOR Modulation

Activates the VOR default setting.

Parameter	Value
State	Off
Mode	Norm
Source	Internal
Bearing Angle	0 deg
Direction	From
VAR / REF Frequency	30 Hz
VAR Depth	30 Percent
Subcarrier Frequency	9960 kHz
Subcarrier Depth	30 Percent
REF Deviation	480 Hz
COM/ID State	Off
COM/ID Frequency	1020 kHz
COM/ID Period	9 s
COM/ID Depth	10 percent

SCPI command:

[\[:SOURce\]:VOR:PRESet](#) on page 611

COM/ID State - VOR Modulation

Switches on/off an additional communication/identification signal (COM/ID signal).

SCPI command:

[:SOURce] :VOR:COMid [:STATe] on page 609

Show Details - VOR Modulation

Reveals the detailed setting options for the COM/ID signal. Once the details are revealed, the labeling on the button changes to "Hide Details". Use this to hide the detailed setting options display again. (COM/ID signal).

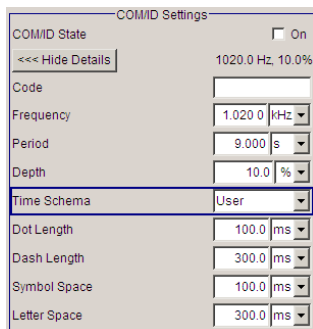

SCPI command:

n.a.

COM/ID Code - VOR Modulation

Enters the coding of the COM/ID signal by the international short name of the airport (e.g. MUC for the Munich airport). (COM/ID signal).

The COM/ID tone is sent according to the selected code (see table of Morse below). The length of the Morse code can be varied. For selection standard time scheme, the selected dot length determines the setting of all other length parameters of the Morse code (dash length, symbol space and letter space). For selection user time scheme, all length parameters of the code can be set independently.

If no coding is entered, the COM/ID tone is sent uncoded (key down).

Table 5-8: Morse Code

Letter	Morse Code	Letter	Morse Code
A	. -	N	- .
B	- . . .	O	- - -
C	- . . .	P	. - - .
D	- . .	Q	- - . -
E	.	R	. - .
F	S	. . .
G	- - .	T	-
H	U	. . -
I	. .	V	. . . -
J	. - - -	W	. - -

Letter	Morse Code	Letter	Morse Code
K	- . -	X	- . . -
L	. - . .	Y	- . - -
M	- -	Z	- - . .

Note:

The following values are default values:

- A dot (.) has a tone duration of 100 ms
- A dash (-) has a tone duration of 300ms
- The time between two tones is 100ms
- The time between two letters is 300ms

After each word a word space is entered. The word repetition rate is 7 words/minute. As the word length can vary between 900 ms and 4500 ms the word space between the words varies accordingly.

Example:

ID code = MUC

The word length =

$300+100+300+300+100+100+100+100+300+300+300+100+100+100+300+100+100 = 3100$ ms

SCPI command:

[\[:SOURce\]:VOR:COMid:CODE](#) on page 605

COM/ID Frequency - VOR Modulation

Enters the frequency of the COM/ID signals.

SCPI command:

[\[:SOURce\]:VOR:COMid:FREQuency](#) on page 606

COM/ID Period - VOR Modulation

Enters the period of the COM/ID signal in seconds.

SCPI command:

[\[:SOURce\]:VOR:COMid:PERiod](#) on page 607

COM/ID Depth - VOR Modulation

Enters the AM modulation depth of the COM/ID signal. The sum of subcarrier depth, VAR depth and COM/ID depth must be smaller than 100 PCT.

SCPI command:

[\[:SOURce\]:VOR:COMid:DEPTh](#) on page 606

COM/ID Time Schema - VOR Modulation

Selects if the set dot length determines the dash length (= three times the dot length) (setting Standard) or if all length parameters can be set independently (setting User). (COM/ID signal).

SCPI command:

[\[:SOURce\]:VOR:COMid:TSCHEMA](#) on page 608

COM/ID Dot Length - VOR Modulation

Enters the length of a Morse dot by means of seconds. The length of the dash (3xdot), space (=dot) and letter space (=3xdot) is also determined by this entry if time scheme standard is selected.

SCPI command:

`[:SOURce] :VOR:COMid:DOT` on page 606

COM/ID Dash Length - VOR Modulation

(user time schema only)

Enters the length of a Morse dash by means of seconds.

SCPI command:

`[:SOURce] :VOR:COMid:DASH` on page 605

COM/ID Symbol Space - VOR Modulation

(user time schema only)

Enters the length of a symbol space by means of seconds.

SCPI command:

`[:SOURce] :VOR:COMid:SYMBOL` on page 608

COM/ID Letter Space - VOR Modulation

(user time schema only)

Enters the length of a letter space by means of seconds.

SCPI command:

`[:SOURce] :VOR:COMid:LETTER` on page 607

Carrier Frequency Step - VOR Modulation

Selects the variation of the carrier frequency via the rotary knob.

"Decimal" Decimal variation according to the current cursor position.

"Defined" Variation in predefined steps according to the standardized VOR transmitting frequencies in MHz (see table [table 5-9](#)).

SCPI command:

`[:SOURce] :VOR:FREQuency:STEP` on page 609

ICAO Channel - VOR Modulation

Selects the ICAO channel, if "Carrier Freq. Knob Step > Defined" is selected.

The individual values in the table cells are:

- **Ch. No.** = ICAO channel number
- **VOR Freq.** = VOR Interrogation frequency (MHz)

Table 5-9: Standardized VOR transmitting frequencies (MHz) and the associated ICAO channels

Ch. No.	VOR Freq.	Ch. No.	VOR Freq.	Ch. No.	VOR Freq.	Ch. No.	VOR Freq.	Ch. No.	VOR Freq.	Ch. No.	VOR Freq.
17X	108.00	45X	110.80	75X	112.80	89X	114.20	103X	115.60	117X	117.00
17Y	108.05	45Y	110.85	75Y	112.85	89Y	114.25	103Y	115.65	117Y	117.05
19X	108.20	47X	111.00	76X	112.90	90X	114.30	104X	115.70	118X	117.10
19Y	108.25	47Y	111.05	76Y	112.95	90Y	114.35	104Y	115.75	118Y	117.15
21X	108.40	49X	111.20	77X	113.00	91X	114.40	105X	115.80	119X	117.20
21Y	108.45	49Y	111.25	77Y	113.05	91Y	114.45	105Y	115.85	119Y	117.25
23X	108.60	51X	111.40	78X	113.10	92X	114.50	106X	115.90	120X	117.30
23Y	108.65	51Y	111.45	78Y	113.15	92Y	114.55	106Y	115.95	120Y	117.35
25X	108.80	53X	111.60	79X	113.20	93X	114.60	107X	116.00	121X	117.40
25Y	108.85	53Y	111.65	79Y	113.25	93Y	114.65	107Y	116.05	121Y	117.45
27X	109.00	55X	111.80	80X	113.30	94X	114.70	108X	116.10	122X	117.50
27Y	109.05	55Y	111.85	80Y	113.35	94Y	114.75	108Y	116.15	122Y	117.55
29X	109.20	57X	112.00	81X	113.40	95X	114.80	109X	116.20	123X	117.60
29Y	109.25	57Y	112.05	81Y	113.45	95Y	114.85	109Y	116.25	123Y	117.65
31X	109.40	58X	112.10	82X	113.50	96X	114.90	110X	116.30	124X	117.70
31Y	109.45	58Y	112.15	82Y	113.55	96Y	114.95	110Y	116.35	124Y	117.75
33X	109.60	59X	112.20	83X	113.60	97X	115.00	111X	116.40	125X	117.80
33Y	109.65	59Y	112.25	83Y	113.65	97Y	115.05	111Y	116.45	125Y	117.85
35X	109.80	70X	112.30	84X	113.70	98X	115.10	112X	116.50	126X	117.90
35Y	109.85	70Y	112.35	84Y	113.75	98Y	115.15	112Y	116.55	126Y	117.95
37X	110.00	71X	112.40	85X	113.80	99X	115.20	113X	116.60		
37Y	110.05	71Y	112.45	85Y	113.85	99Y	115.25	113Y	116.65		
39X	110.20	72X	112.50	86X	113.90	100X	115.30	114X	116.75		
39Y	110.25	72Y	112.55	86Y	113.95	100Y	115.35	114Y	116.75		
41X	110.40	73X	112.60	87Y	114.00	101X	115.40	115X	116.80		
41Y	110.45	73Y	112.65	87Y	114.05	101Y	115.45	115Y	116.85		
43X	110.60	74X	112.70	88X	114.10	102X	115.50	116X	116.90		
43Y	110.65	74Y	112.75	88Y	114.15	102Y	115.55	116Y	116.95		

SCPI command:

[:SOURce] :VOR: ICAO: CHANnel on page 609

EXT AM - VOR Modulation

Switching on/off an external modulation. The external signal is input via the AM EXT connector.

"Off" Selects the internal modulation source for VOR modulation.

"EXT (MOD AM)"

Selects the external source. The external signal is added to the internal signal. Switching off the internal source is not possible. The external signal is input via the AM EXT connector. The sensitivity is 10 mV per percent modulation depth.

Note: There can be an overmodulation as a function of the level of the external signal without a corresponding caution message being generated. In order to avoid an overmodulation, the peak value of the external signal is to be delimited corresponding to the sum of the modulation depths of the remaining VOR signal components.

SCPI command:

[:SOURce] :VOR: SOURce on page 612

5.4.9 ILS-GS Modulation

ILS-GS modulation (Instrument Landing System - Glide Slope) is available for the basic unit (R&S SMA + frequency option R&S SMA-B10x) equipped with option R&S SMA-K25.

ILS systems provide information relating to the position of the air plane relative to the runway during landing. The ILS-GS system indicates if the air plane is above, below or on the glide path. The carrier is modulated by a 90 Hz and a 150 Hz tone and sent to a separate directional antenna system. The antenna array is arranged so that the 90 Hz signal is stronger above of the glide path, and the 150 Hz signal is stronger below the glide path. The information on position is provided after demodulation of the signals by evaluating the difference in depth of modulation (DDM).

Three different modes are offered for the ILS-GS test signal:

- Norm
Standard localizer/glideslope signal
- 90 Hz
Suppression of the 150 Hz modulation tone
- 150 Hz
Suppression of the 90 Hz modulation tone

An external signal can be added to the internal signal (EXT AM = EXT (MOD AM)). The external signal is input via the AM EXT connector.

The ILS-GS signal is output at the LF OUT connector at the front of the instrument.

5.4.9.1 ILS-GS Modulation Settings

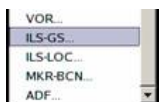

The "ILS-GS Modulation" dialog is opened in the "Mod" function block or using the MENU key under "Mod".

In the upper section, the modulation source is selected and the modulation switched on. The configuration of the selected external and/or internal modulation source is performed in the lower section of the dialog.

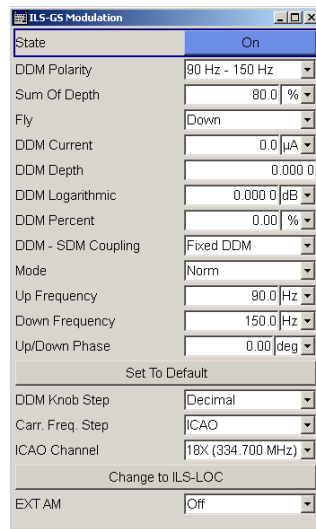

State - ILS-GS Modulation

Activates ILS-GS modulation.

Activation of ILS-GS modulation deactivates AM, VOR, ILS-LOC, Marker Beacon and ADF modulation.

Source selection and the associated parameters are disabled in the "LF Generator / Output" dialog:

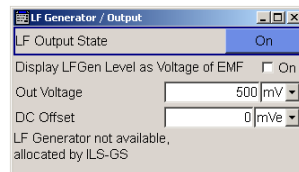

SCPI command:

[\[:SOURce\]:ILS:GS|GSLoPe:STATe](#) on page 524

DDM Polarity - ILS-GS Modulation

Defines the polarity for DDM calculation (see DDM Depth).

SCPI command:

[\[:SOURce\]:ILS\[:GS|GSLoPe\]:DDM:POLarity](#) on page 518

Sum of Depth - ILS-GS Modulation

Enters the arithmetic sum of the modulation depths of the upper lobe (90Hz) and lower lobe (150Hz) ILS-GS signal contents. The RMS modulation depth of the sum signal depends on the phase setting of both modulation tones. The sum of Sum of Depth and COM/ID depth must be smaller than 100 PCT.

SCPI command:

[\[:SOURce\]:ILS\[:GS|GSLoPe\]:SDM](#) on page 523

Fly - ILS-GS Modulation

Selects the simulation mode for the ILS-GS modulation signal. A change of the setting automatically changes the sign of the DDM value.

This setting simulates the direction in which the pilot has to correct the course.

- "Up" The 150-Hz modulation signal is predominant, the DDM value is negative (the airplane is too low, it must climb).
- "Down" The 90-Hz modulation signal is predominant, the DDM value is positive (the airplane is too high, it must descend).

SCPI command:

[\[:SOURce\]:ILS\[:GS|GSLope\]:DDM:DIRection](#) on page 516

DDM Current - ILS-GS Modulation

Enters the current of the ILS indicating instrument corresponding to the DDM value. the instrument current is calculated according to:

$$\text{DDM } \mu\text{A} = \text{DDM} \times 857,125 \text{ } \mu\text{A}$$

A variation of the instrument current automatically leads to a variation of the DDM value and the DDM value in dB.

SCPI command:

[\[:SOURce\]:ILS\[:GS|GSLope\]:DDM:CURRent](#) on page 515

DDM Depth - ILS-GS Modulation

Enters the difference in depth of modulation between the upper lobe (90Hz) and the lower lobe (150Hz) tone of the ILS-GS modulation signal.

The DDM value is calculated to formula:

- Polarity 90 Hz - 150 Hz (default setting):
DDM = [AM(90 Hz) - AM (150 Hz)] / 100%
- Polarity 150 Hz - 90 Hz:
DDM = [AM(150 Hz) - AM (90 Hz)] / 100%

A variation of the DDM value automatically leads to a variation of the value of the instrument current and the DDM value in dB.

SCPI command:

[\[:SOURce\]:ILS\[:GS|GSLope\]:DDM\[:DEPTh\]](#) on page 515

DDM Logarithmic - ILS-GS Modulation

Enters the DDM value in dB. The dB value is calculated according to:

$$\text{DDM dB} = 20 \times \text{LOG} [(\text{SDM} + \text{DDM} \times 100\%) / (\text{SDM} - \text{DDM} \times 100\%)]$$

A variation of the value automatically leads to a variation of the DDM value and the instrument current.

SCPI command:

[\[:SOURce\]:ILS\[:GS|GSLope\]:DDM:LOGarithmic](#) on page 517

DDM Percent - ILS-GS Modulation

Enters the difference in depth of modulation between the upper lobe (90Hz) and the lower lobe (150Hz) tone of the ILS-GS modulation signal.

The DDM value in percent is calculated to formula:

- Polarity 90 Hz - 150 Hz (default setting):
DDM = [AM(90 Hz) - AM (150 Hz)]
- Polarity 150 Hz - 90 Hz:
DDM = [AM(150 Hz) - AM (90 Hz)]

A variation of the DDM value automatically leads to a variation of the value of the instrument current and the DDM value in dB.

SCPI command:

[\[:SOURce\] : ILS \[:GS | GSLOpe\] : DDM : PCT](#) on page 517

DDM - SDM Coupling - ILS-GS Modulation

Selects if the DDM value is fixed or is changed with a change of sum of modulation depths (SDM, see below).

"Fixed" The absolute DDM values stays constant when the SDM is changed.

"SDM" The absolute DDM values changes when the SDM is changed. The DDM value expressed in dB stays constant.

SCPI command:

[\[:SOURce\] : ILS \[:GS | GSLOpe\] : DDM : COUPling](#) on page 515

Mode - ILS-GS Modulation

Selects the operating mode for the ILS-GS modulation signal.

"Norm" ILS-GS modulation is active.

"90 Hz" Amplitude modulation of the output signal with the upper lobe signal component (90Hz signal content) of the ILS-GS signal.

The modulation depth of the 90-Hz signal results from the settings of parameters "Sum of depth (SDM)" and "DDM" according to:

- "Direction Down"
 $AM(90\text{ Hz}) = 0.5 \times (\text{SDM} + \text{DDM} \times 100\%)$
- "Direction Up"
 $AM(90\text{ Hz}) = 0.5 \times (\text{SDM} - \text{DDM} \times 100\%)$

"150 Hz" Amplitude modulation of the output signal with the lower lobe signal component (150-Hz signal content) of the ILS-GS signal.

The modulation depth of the 150-Hz signal results from the settings of parameters "Sum of depth (SDM)" and "DDM" according to:

- "Direction Down"
 $AM(150\text{ Hz}) = 0,5 \times (\text{SDM} + \text{DDM} \times 100\%)$
- "Direction Up"
 $AM(150\text{ Hz}) = 0,5 \times (\text{SDM} - \text{DDM} \times 100\%)$

SCPI command:

[\[:SOURce\] : ILS \[:GS | GSLOpe\] : MODE](#) on page 520

Up Frequency - ILS-GS Modulation

Enters the modulation frequency of the upper antenna lobe.

SCPI command:

[\[:SOURce\] : ILS \[:GS | GSLOpe\] : ULObE \[:FREQuency\]](#) on page 524

Down Frequency - ILS-GS Modulation

Enters the modulation frequency of the lower antenna lobe .

SCPI command:

[\[:SOURce\] : ILS \[:GS | GSLOpe\] : LLOBe \[:FREQuency\]](#) on page 519

Up/Down Phase - ILS-GS Modulation

Enters the phase between the modulation signals of the upper and lower antenna lobe. The zero crossing of the lower lobe (150Hz) signal serves as a reference. The angle refers to the period of the signal of the lower antenna lobe.

SCPI command:

`[:SOURce] : ILS [:GS | GSLope] : PHASe` on page 521

Set to Default - ILS-GS Modulation

Activates the ILS-GS default setting.

Parameter	Value
State	Off
Sum of Depth	80 Percent
Fly	Up
DDM	0
Mode	Norm
Up Frequency	90 Hz
Down Frequency	150 Hz
Up/Down Phase	0 deg
COM/ID State	Off
COM/ID Frequency	1020 kHz
COM/ID Depth	10 percent

SCPI command:

`[:SOURce] : ILS [:GS | GSLope] : PRESet` on page 522

DDM Knob Step - ILS-GS Modulation

Selects the variation of the DDM values via the rotary knob.

"Decimal" Decimal variation according to the current cursor position.

"Defined" Variation in predefined steps according to the standardized DDM values:

- -0.4000
- -0.1750 (Glide Sector)
- -0.0910, 0,0450
- 0.0000 (Glide Path)
- +0.0450, +0,0910
- +0.1750 (Glide Sector)
- +0.4000

SCPI command:

n.a.

Carrier Frequency Step - ILS-GS Modulation

Selects the variation of the carrier frequency via the rotary knob.

"Decimal" Decimal variation according to the current cursor position.

"ICAO" Activates variation in predefined steps according to the standardized ILS-GS transmitting frequencies (see table, values in MHz). The start value can be selected in the field "ICAO Channel" below. The selection of the ICAO channel is effective on both ILS modulations. A change to modulation ILS-LOC automatically causes the RF frequency to be adapted to the localizer value which is coupled to the glide slope setting (see table).

The individual values in the table are:

- **Ch. No.** = ICAO channel number
- **LOC Freq.** = ILS Localizer transmitting frequency (MHz)
- **GS Freq.** = ILS GS frequency (MHz)

Table 5-10: Standardized ILS-GS and ILS-LOC transmitting frequencies (MHz) and the associated ICAO channels

Ch. No.	LOC Freq.	GS Freq.	Ch. No.	LOC Freq.	GS Freq.	Ch. No.	LOC Freq.	GS Freq.
18X	108.10	334.70	32X	109.50	332.60	46X	110.90	330.80
18Y	108.15	334.55	32Y	109.55	332.45	46Y	110.95	330.65
20X	108.30	334.10	34X	109.70	333.20	48X	111.10	331.70
20Y	108.35	333.95	34Y	109.75	333.05	48Y	111.15	331.55
22X	108.50	329.90	36X	109.90	333.80	50X	111.30	332.30
22Y	108.55	329.75	36Y	109.95	333.65	50Y	111.35	332.15
24X	108.70	330.50	38X	110.10	334.40	52X	111.50	332.90
24Y	108.75	330.35	38Y	110.15	334.25	52Y	111.55	332.75
26X	108.90	329.30	40X	110.30	335.00	54X	111.70	333.50
26Y	108.95	329.15	40Y	110.35	334.85	54Y	111.75	333.35
28X	109.10	331.40	42X	110.50	329.60	56X	111.90	331.10
28Y	109.15	331.25	42Y	110.55	329.45	56Y	111.95	330.95
30X	109.30	332.00	44X	110.70	330.20			
30Y	109.35	331.85	44Y	110.75	330.05			

SCPI command:

[\[:SOURce\]:ILS\[:GS|GSlope\]:FREQuency:STEP](#) on page 518

ICAO Channel - ILS-GS Modulation

Selects the ICAO channel, i.e., the ILS-GS transmitting frequency. The RF-frequency is set to the value selected here. A variation of the carrier frequency by the rotary knob is performed in predefined steps according to the standardized ILS-GS transmitting frequencies (see table). The ICAO channel settings for ILS-GS and ILS-LOC are coupled.

SCPI command:

[\[:SOURce\]:ILS\[:GS|GSlope\]:ICAO:CHANnel](#) on page 519

Change to ILS-LOC - ILS-GS Modulation

Changes to ILS-LOC modulation and opens the menu. The current state of the ILS GS modulation (On or Off) is also set for ILS-LOC. The RF frequency setting automatically changes to the transmitting frequency associated with the set ICAO channel for ILS-LOC if the state is on. .

SCPI command:

n.a.

EXT AM - ILS-GS Modulation

Switching on/off an external modulation. The external signal is input via the AM EXT connector.

"Off"	Selects the internal modulation source for ILS-GS modulation.
"EXT (MOD AM)"	Selects the external source. The external signal is added to the internal signal. Switching off the internal source is not possible. The external signal is input via the AM EXT connector. The sensitivity is 10 mV per percent modulation depth.

Note: There can be an overmodulation as a function of the level of the external signal without a corresponding caution message being generated. In order to avoid an overmodulation, the peak value of the external signal is to be delimited corresponding to the sum of the modulation depths of the remaining ILS signal components.

SCPI command:

[:SOURce] : ILS [:GS | GSLope] : SOURce on page 523

5.4.10 ILS-LOC Modulation

ILS-LOC modulation (Instrument Landing System - Localizer) is available for the basic unit (R&S SMA + frequency option R&S SMA-B10x) equipped with option R&S SMA-K25.

ILS systems provide information relating to the position of the air plane relative to the runway during landing. The ILS-LOC system indicates if the air plane is to the left, right or on the glide path. The carrier is modulated by a 90 Hz and a 150 Hz tone and sent to a separate directional antenna system. The antenna array is arranged so that the 90 Hz signal is stronger on the left side of the glide path, and the 150 kHz signal is stronger on the right side of the glide path. The information on position is provided after demodulation of the signals by evaluating the difference in depth of modulation (DDM).

Three different modes are offered for the ILS-LOC test signal:

- Normal
Standard localizer/glideslope signal + optional COM/ID tone (can be switched on)
- 90 Hz
Suppression of 150 Hz modulation tone
- 150 Hz
Suppression of 90 Hz modulation tone

An external signal can be added to the internal signal (EXT AM = EXT (MOD AM)). The external signal is input via the AM EXT connector at the rear of the instrument.

The ILS-LOC signal is output at the LF OUT connector at the front of the instrument.

5.4.10.1 ILS-Localizer Modulation Settings

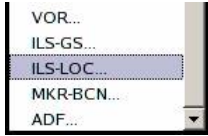

The "ILS-LOC Modulation" dialog is opened in the "Mod" function block or using the MENU key under "Mod".

In the upper section, the modulation source is selected and the modulation switched on. The configuration of the selected external and/or internal modulation source is performed in the lower section of the dialog.

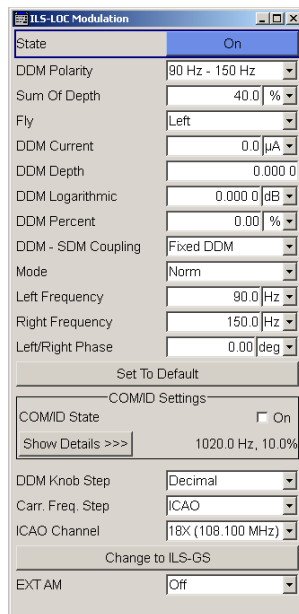

State - ILS-LOC Modulation

Activates ILS-LOC modulation.

Activation of ILS-LOC modulation deactivates AM, VOR, ILS-GS, Marker Beacon and ADF modulation.

Source selection is disabled in the "LF Generator / Output" dialog:

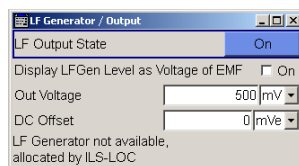

SCPI command:

`[:SOURce] : ILS : LOCalizer : STATe` on page 524

DDM Polarity- ILS-LOC Modulation

Defines the polarity for DDM calculation (see DDM Depth).

SCPI command:

`[:SOURce] : ILS : LOCalizer : DDM : POLarity` on page 518

Sum of Depth - ILS-LOC Modulation

Enters the arithmetic sum of the modulation depths of the left lobe (90Hz) and right lobe (150Hz) ILS-LOC signal contents. The RMS modulation depth of the sum signal depends on the phase setting of both modulation tones. The sum of Sum of Depth and COM/ID depth must be smaller than 100 PCT.

SCPI command:

[\[:SOURce\]:ILS:LOCalizer:SDM](#) on page 523

Fly - ILS-LOC Modulation

Selects the simulation mode for the ILS-LOC modulation signal. A change of the setting automatically changes the sign of the DDM value.

This setting simulates the direction in which the pilot has to correct the course.

"Left" The 150-Hz modulation signal is predominant, the DDM value is negative (the airplane is too far to the right, it must turn to the left).

"Right" The 90-Hz modulation signal is predominant, the DDM value is positive (the airplane is too far to the left, it must turn to the right).

SCPI command:

[\[:SOURce\]:ILS:LOCalizer:DDM:DIRection](#) on page 516

DDM Current - ILS-LOC Modulation

Enters the current of the ILS indicating instrument corresponding to the DDM value. The instrument current is calculated according to:

$$\text{DDM } \mu\text{A} = \text{DDM} \times 967.75 \text{ } \mu\text{A}$$

A variation of the instrument current automatically leads to a variation of the DDM value and the DDM value in dB.

SCPI command:

[\[:SOURce\]:ILS:LOCalizer:DDM:CURRent](#) on page 515

DDM Depth - ILS-LOC Modulation

Enters the difference in depth of modulation between the signal of the left lobe (90 Hz) and the right lobe (150 Hz).

The DDM value is calculated to formula:

- Polarity 90 Hz - 150 Hz (default setting):
DDM = [AM(90 Hz) - AM (150 Hz)] / 100%
- Polarity 150 Hz - 90 Hz:
DDM = [AM(150 Hz) - AM (90 Hz)] / 100%

A variation of the DDM value automatically leads to a variation of the DDM value in dB and the value of the instrument current.

SCPI command:

[\[:SOURce\]:ILS:LOCalizer:DDM\[:DEPTh\]](#) on page 515

DDM Logarithmic - ILS-LOC Modulation

Enters the DDM value in dB. The dB value is calculated according to:

$$\text{DDM dB} = 20 \times \text{LOG} \left[\frac{(\text{SDM} + \text{DDM} \times 100\%)}{(\text{SDM} - \text{DDM} \times 100\%)} \right]$$

A variation of the value automatically leads to a variation of the DDM value and the instrument current.

SCPI command:

[\[:SOURce\]:ILS:LOCalizer:DDM:LOGarithmic](#) on page 517

DDM Percent - ILS-LOC Modulation

Enters the difference in depth of modulation between the signal of the left lobe (90 Hz) and the right lobe (150 Hz).

The DDM value in percent is calculated to formula:

- Polarity 90 Hz - 150 Hz (default setting):
DDM = [AM(90 Hz) - AM (150 Hz)]
- Polarity 150 Hz - 90 Hz:
DDM = [AM(150 Hz) - AM (90 Hz)]

A variation of the DDM value automatically leads to a variation of the DDM value in dB and the value of the instrument current.

SCPI command:

[\[:SOURce\]:ILS:LOCalizer:DDM:PCT](#) on page 517

DDM - SDM Coupling - ILS-LOC Modulation

Selects if the DDM value is fixed or is changed with a change of sum of modulation depths (SDM, see below).

- | | |
|---------|--|
| "Fixed" | The absolute DDM values stays constant when the SDM is changed. |
| "SDM" | The absolute DDM values changes when the SDM is changed. The DDM value expressed in dB stays constant. |

SCPI command:

[\[:SOURce\]:ILS:LOCalizer:DDM:COUPling](#) on page 515

Mode - ILS-LOC Modulation

Selects the operating mode for the ILS-LOC modulation signal.

- | | |
|---------|---|
| "Norm" | ILS-LOC modulation is active. |
| "90 Hz" | Amplitude modulation of the output signal with the left lobe (90Hz) signal component of the ILS-LOC signal. |

The modulation depth of the 90Hz signal results from the settings of parameters "Sum of depth (SDM)" and "DDM" according to:

- parameter "Fly" = "Right"
 $AM(90\text{ Hz}) = 0,5 \times (\text{SDM} + \text{DDM} \times 100\%)$
- parameter "Fly" = "Left"
 $AM(90\text{ Hz}) = 0,5 \times (\text{SDM} - \text{DDM} \times 100\%)$

"150 Hz" Amplitude modulation of the output signal with the right lobe (150Hz) signal component of the ILS-LOC signal.

The modulation depth of the 150Hz signal results from the settings of parameters "Sum of depth (SDM)" and "DDM" according to:

- parameter "Fly" = "Right"
AM (150 Hz) = $0,5 \times (\text{SDM} + \text{DDM} \times 100\%)$
- parameter "Fly" = "Left"
AM (150 Hz) = $0,5 \times (\text{SDM} - \text{DDM} \times 100\%)$

SCPI command:

`[:SOURce] : ILS : LOCalizer : MODE` on page 521

Left Frequency - ILS-LOC Modulation

Enters the modulation frequency of the antenna lobe arranged at the left viewed from the air plane.

SCPI command:

`[:SOURce] : ILS : LOCalizer : LLOBe [:FREQuency]` on page 519

Right Frequency - ILS-LOC Modulation

Enters the modulation frequency of the antenna lobe arranged at the right viewed from the air plane.

SCPI command:

`[:SOURce] : ILS : LOCalizer : RLOBe [:FREQuency]` on page 522

Left/Right Phase - ILS-LOC Modulation

Enters the phase between the modulation signals of the left and right antenna lobe. The zero crossing of the right lobe (150Hz) signal serves as a reference. The angle refers to the period of the signal of the right antenna lobe.

SCPI command:

`[:SOURce] : ILS : LOCalizer : PHASe` on page 521

Set to Default - ILS-LOC Modulation

Activates the ILS-LOC default setting.

Parameter	Value
State	Not affected by Set to default
Sum of Depth	40 Percent
Fly	Up
DDM	0
Mode	Norm
Left frequency	90 Hz
Right Frequency	150 Hz
Left/Right Phase	0 deg
COM/ID State	Off

Parameter	Value
COM/ID Frequency	1020 kHz
COM/ID Period	9 s
COM/ID Depth	10 percent

SCPI command:

[\[:SOURce\]:ILS:LOCalizer:PRESet](#) on page 522

COM/ID State - ILS-LOC Modulation

Switches on/off an additional communication/identification signal (COM/ID signal).

SCPI command:

[\[:SOURce\]:ILS:LOCalizer:COMid\[:STATe\]](#) on page 513

Show Details - ILS-LOC Modulation

Reveals the detailed setting options for the COM/ID signal. Once the details are revealed, the labeling on the button changes to "Hide Details". Use this to hide the detailed setting options display again. (COM/ID signal).

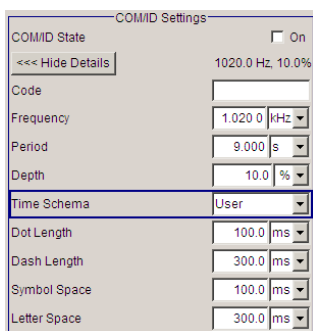

SCPI command:

n.a.

COM/ID Code - ILS-LOC Modulation

Enters the coding of the COM/ID signal by the international short name of the airport (e.g. MUC for the Munich airport). (COM/ID signal).

The COM/ID tone is sent according to the selected code (see table of Morse below). The length of the Morse code can be varied. For selection standard time scheme, the selected dot length determines the setting of all other length parameters of the Morse code (dash length, symbol space and letter space). For selection user time scheme, all length parameters of the code can be set independently.

If no coding is entered, the COM/ID tone is sent uncoded (key down).

Table 5-11: Morse Code

Letter	Morse Code	Letter	Morse Code
A	. -	N	- .
B	- . . .	O	- - -
C	- . . .	P	. - - .

Letter	Morse Code	Letter	Morse Code
D	-...	Q	---..
E	.	R	..-
F	...-	S	...-
G	--.	T	-
H	U	...-
I	..	V	...-
J	.-.-	W	..--
K	-.-	X	-.--
L	.-..	Y	-.--
M	--	Z	---..

Note:

The following values are default values:

- A dot (.) has a tone duration of 100 ms
- A dash (-) has a tone duration of 300ms
- The time between two tones is 100ms
- The time between two letters is 300ms

After each word a word space is entered. The word repetition rate is 7 words/minute. As the word length can vary between 900 ms and 4500 ms the word space between the words varies accordingly.

Example:

ID code = MUC

The word length =

$300+100+300+300+100+100+100+100+300+300+300+100+100+100+300+100+100 = 3100$ ms

SCPI command:

[\[:SOURCE\]:ILS:LOCALizer:COMid:CODE](#) on page 510

COM/ID Frequency - ILS-LOC Modulation

Enters the frequency of the COM/ID signals.

SCPI command:

[\[:SOURCE\]:ILS:LOCALizer:COMid:FREQuency](#) on page 512

COM/ID Period - ILS-LOC Modulation

Enters the period of the COM/ID signal in seconds.

SCPI command:

[\[:SOURCE\]:ILS:LOCALizer:COMid:PERiod](#) on page 513

COM/ID Depth - ILS-LOC Modulation

Enters the AM modulation depth of the COM/ID signal. The sum of subcarrier depth, VAR depth and COM/ID depth must be smaller than 100 PCT.

SCPI command:

[\[:SOURce\]:ILS:LOCalizer:COMid:DEPTh](#) on page 511

COM/ID Time Schema - ILS-LOC Modulation

Selects if the set dot length determines the dash length (= three times the dot length) (setting Standard) or if all length parameters can be set independently (setting User). (COM/ID signal).

SCPI command:

[\[:SOURce\]:ILS:LOCalizer:COMid:TSCHEMA](#) on page 514

COM/ID Dot Length - ILS-LOC Modulation

Enters the length of a Morse dot by means of seconds. The length of the dash (3xdot), space (=dot) and letter space (=3xdot) is also determined by this entry if time scheme standard is selected.

SCPI command:

[\[:SOURce\]:ILS:LOCalizer:COMid:DOT](#) on page 512

COM/ID Dash Length - ILS-LOC Modulation

(user time schema only)

Enters the length of a Morse dash by means of seconds.

SCPI command:

[\[:SOURce\]:ILS:LOCalizer:COMid:DASH](#) on page 511

COM/ID Symbol Space - ILS-LOC Modulation

(user time schema only)

Enters the length of a symbol space by means of seconds.

SCPI command:

[\[:SOURce\]:ILS:LOCalizer:COMid:SYMBOL](#) on page 514

COM/ID Letter Space - ILS-LOC Modulation

(user time schema only)

Enters the length of a letter space by means of seconds.

SCPI command:

[\[:SOURce\]:ILS:LOCalizer:COMid:LETTER](#) on page 512

DDM Knob Step - ILS-LOC Modulation

Selects the variation of the DDM values via the rotary knob.

"Decimal" Decimal variation according to the current cursor position.

- "Defined" Variation in predefined steps according to the standardized DDM values:
- -0,2000
 - -0.1550 (Course Sector)
 - -0,0930, -0,0460
 - 0,0000 (Course Line)
 - +0,0460, +0,0930
 - +0,1550 (Course Sector)
 - +0,2000

SCPI command:
n.a.

Carrier Frequency Step - ILS-LOC Modulation

Selects the variation of the carrier frequency via the rotary knob.

- "Decimal" Decimal variation according to the current cursor position.

"ICAO"

Activates variation in predefined steps according to the standardized ILS-GS transmitting frequencies (see table, values in MHz). The start value can be selected in the field "ICAO Channel" below.

The selection is effective on both ILS modulations. A change to modulation ILS-GS automatically causes the RF frequency to be adapted to the glide slope value which is coupled to the localizer setting (see table).

The individual values in the table are:

- **Ch. No.** = ICAO channel number
- **LOC Freq.** = ILS Localizer transmitting frequency (MHz)
- **GS Freq.** = ILS GS frequency (MHz)

Table 5-12: Standardized ILS-GS and ILS-LOC transmitting frequencies (MHz) and the associated ICAO channels

Ch. No.	LOC Freq.	GS Freq.	Ch. No.	LOC Freq.	GS Freq.	Ch. No.	LOC Freq.	GS Freq.
18X	108.10	334.70	32X	109.50	332.60	46X	110.90	330.80
18Y	108.15	334.55	32Y	109.55	332.45	46Y	110.95	330.65
20X	108.30	334.10	34X	109.70	333.20	48X	111.10	331.70
20Y	108.35	333.95	34Y	109.75	333.05	48Y	111.15	331.55
22X	108.50	329.90	36X	109.90	333.80	50X	111.30	332.30
22Y	108.55	329.75	36Y	109.95	333.65	50Y	111.35	332.15
24X	108.70	330.50	38X	110.10	334.40	52X	111.50	332.90
24Y	108.75	330.35	38Y	110.15	334.25	52Y	111.55	332.75
26X	108.90	329.30	40X	110.30	335.00	54X	111.70	333.50
26Y	108.95	329.15	40Y	110.35	334.85	54Y	111.75	333.35
28X	109.10	331.40	42X	110.50	329.60	56X	111.90	331.10
28Y	109.15	331.25	42Y	110.55	329.45	56Y	111.95	330.95
30X	109.30	332.00	44X	110.70	330.20			
30Y	109.35	331.85	44Y	110.75	330.05			

SCPI command:

[\[:SOURCE\]:ILS:LOCALizer:FREQUENCY:STEP](#) on page 518

ICAO Channel - ILS-LOC Modulation

Selects the ICAO channel, i.e., the ILS-LOC transmitting frequency. The RF-frequency is set to the value selected here. A variation of the carrier frequency by the rotary knob is performed in predefined steps according to the standardized ILS-LOC transmitting frequencies (see table). The ICAO channel settings for ILS-GS and ILS-LOC are coupled.

SCPI command:

[\[:SOURCE\]:ILS:LOCALizer:ICAO:CHANNEL](#) on page 519

Change to ILS-GS - ILS-LOC Modulation

Changes to ILS-GS modulation and opens the menu. The state of the ILS LOC modulation (On or Off) is also set for ILS-GS. The RF frequency setting automatically changes to the transmitting frequency associated with the set ICAO channel for ILS-GS if the state is on.

SCPI command:

n.a.

EXT AM - ILS-LOC Modulation

Switching on/off an external modulation. The external signal is input via the AM EXT connector.

"Off" Selects the internal modulation source for ILS-LOC modulation.

"EXT (MOD AM)" Selects the external source. The external signal is added to the internal signal. Switching off the internal source is not possible. The external signal is input via the AM EXT connector. The sensitivity is 10 mV per percent modulation depth.

Note: There can be an overmodulation as a function of the level of the external signal without a corresponding caution message being generated. In order to avoid an overmodulation, the peak value of the external signal is to be delimited corresponding to the sum of the modulation depths of the remaining ILS signal components.

SCPI command:

[\[:SOURce\]:ILS:LOCalizer:SOURce](#) on page 523

5.4.11 Marker Beacon Modulation

Marker Beacon modulation is available for the basic unit (R&S SMA + frequency option R&S SMA-B10x) equipped with option R&S SMA-K25.

The Marker Beacon signal is output at the LF OUT connector at the front of the instrument.

ILS systems provide information relating to the position of the air plane relative to the runway during landing. The Markers indicate the distance of the air plane relative to the threshold of the runway. The modulation frequency changes from outer to the inner marker which are located at a defined distance from the runway. The altitude of the air plane should be 200 feet by the time the middle marker with a modulation frequency of 1300 Hz is reached.

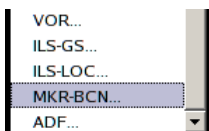
5.4.11.1 Marker Beacon Modulation Menu

The "Marker Beacon Modulation" menu is opened in the "Mod" function block or using the MENU key under "Mod".

In the upper section of the menu, the modulation source is selected and the modulation switched on. The configuration of the selected external and/or internal modulation source is performed in the lower section of the menu.

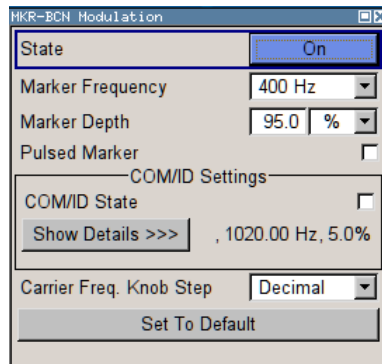

State - Marker Beacon Modulation

Activates/deactivates Marker Beacon modulation.

Activation of Marker Beacon modulation deactivates AM, VOR, ILS and ADF modulation.

Source selection is disabled in the "LF Output" menu:

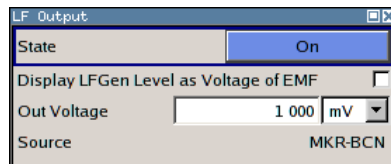

SCPI command:

[\[:SOURCE\]:MBeacon:STATE](#) on page 556

Marker Frequency - Marker Beacon Modulation

Enters the modulation frequency of the marker signal.

SCPI command:

[\[:SOURCE\]:MBeacon\[:MARKer\]:FREQUENCY](#) on page 557

Marker Depth - Marker Beacon Modulation

Enters the modulation depth of the marker signal.

SCPI command:

[\[:SOURCE\]:MBeacon\[:MARKer\]:DEPTH](#) on page 556

Pulsed Marker - Marker Beacon Modulation

Activates/deactivates pulsed marker.

If activated, the markers are output with the following on/off ratio:

	On	Off
Outer Marker (400 Hz)	375 ms	125 ms
Middle Marker (1300 Hz)	375 ms 83 ms	125 ms 83 ms
Inner Marker (3000 Hz)	83 ms	83 ms (6dots/sec)

If deactivated, the markers are output uncoded (key down).

SCPI command:

`[:SOURce] :MBEacon [:MARKer] :PULSed` on page 557

COM/ID State - Marker Beacon Modulation

Switches on/off an additional communication/identification signal (COM/ID signal).

SCPI command:

`[:SOURce] :MBEacon:COMid [:STATe]` on page 555

Show Details - Marker Beacon Modulation

Reveals the detailed setting options for the COM/Id signal. Once the details are revealed, the labeling on the button changes to "Hide Details". Use this to hide the detailed setting options display again. (COM/ID signal).

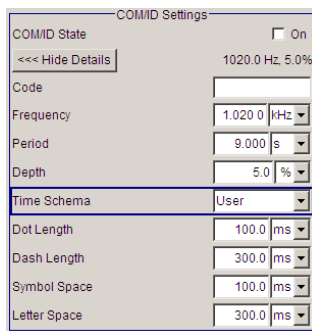

SCPI command:

n.a.

COM/ID Code - Marker Beacon Modulation

Enters the coding of the COM/ID signal by the international short name of the airport (e.g. MUC for the Munich airport). (COM/ID signal).

The COM/ID tone is sent according to the selected code (see table of Morse below). The length of the Morse code can be varied. For selection standard time scheme, the selected dot length determines the setting of all other length parameters of the Morse code (dash length, symbol space and letter space) . For selection user time scheme, all length parameters of the code can be set independently.

If no coding is entered, the COM/ID tone is sent uncoded (key down).

Table 5-13: Morse Code

Letter	Morse Code	Letter	Morse Code
A	. -	N	- .
B	- . . .	O	- - -
C	- . - .	P	. - - .
D	- . .	Q	- - . -
E	.	R	. - .
F	. . - .	S	. . .
G	- - .	T	-

Letter	Morse Code	Letter	Morse Code
H	U	...-
I	..	V	...-
J	.---	W	..--
K	-.-	X	-...-
L	.-...	Y	-.-.-
M	--	Z	--...

Note:

The following values are default values:

- A dot (.) has a tone duration of 100 ms
- A dash (-) has a tone duration of 300ms
- The time between two tones is 100ms
- The time between two letters is 300ms

After each word a word space is entered. The word repetition rate is 7 words/minute. As the word length can vary between 900 ms and 4500 ms the word space between the words varies accordingly.

Example:

ID code = MUC

The word length =

$300+100+300+300+100+100+100+100+300+300+300+100+100+100+300+100+100 = 3100$ ms

SCPI command:

[\[:SOURCE\]:MBEacon:COMid:CODE](#) on page 551

COM/ID Frequency - Marker Beacon Modulation

Enters the frequency of the COM/ID signals.

SCPI command:

[\[:SOURCE\]:MBEacon:COMid:FREQUENCY](#) on page 553

COM/ID Period - Marker Beacon Modulation

Enters the period of the COM/ID signal in seconds.

SCPI command:

[\[:SOURCE\]:MBEacon:COMid:PERIOD](#) on page 554

COM/ID Depth - Marker Beacon Modulation

Enters the AM modulation depth of the COM/ID signal. The sum of subcarrier depth, VAR depth and COM/ID depth must be smaller than 100 PCT.

SCPI command:

[\[:SOURCE\]:MBEacon:COMid:DEPTH](#) on page 552

COM/ID Time Schema - Marker Beacon Modulation

Selects if the set dot length determines the dash length (= three times the dot length) (setting Standard) or if all length parameters can be set independently (setting User). (COM/ID signal).

SCPI command:

[\[:SOURce\]:MBEacon:COMid:TSCHEMA](#) on page 555

COM/ID Dot Length - Marker Beacon Modulation

Enters the length of a Morse dot by means of seconds. The length of the dash (3xdot), space (=dot) and letter space (=3xdot) is also determined by this entry if time scheme standard is selected.

SCPI command:

[\[:SOURce\]:MBEacon:COMid:DOT](#) on page 553

COM/ID Dash Length - Marker Beacon Modulation

(user time schema only)

Enters the length of a Morse dash by means of seconds.

SCPI command:

[\[:SOURce\]:MBEacon:COMid:DASH](#) on page 552

COM/ID Symbol Space - Marker Beacon Modulation

(user time schema only)

Enters the length of a symbol space by means of seconds.

SCPI command:

[\[:SOURce\]:MBEacon:COMid:SYMBOL](#) on page 554

COM/ID Letter Space - Marker Beacon Modulation

(user time schema only)

Enters the length of a letter space by means of seconds.

SCPI command:

[\[:SOURce\]:MBEacon:COMid:LETTER](#) on page 553

Carrier Frequency Knob Step - Marker Beacon Modulation

Selects the variation of the carrier frequency via the rotary knob.

"Decimal"

Decimal variation according to the current cursor position.

An RF frequency of 75 MHz is automatically set when Marker Beacon modulation is switched on.

"Defined" Variation in predefined steps according to the standardized Marker Beacon transmitting frequencies (see table, values in MHz)

Note: If Defined is selected, the current RF frequency is automatically switched over to the next Marker Beacon transmitting frequency acc. to the table when switching on the modulation.

Table 5-14: Standardized Marker beacon transmitting frequencies (MHz)

74.600	75.675	74.750	74.825	74.900	74.975	75.050	75.125	75.200	75.275	75.350
74.625	74.700	74.775	74.850	74.925	75.000	75.075	75.150	75.225	75.300	75.375
74.650	74.725	74.800	74.875	74.950	75.025	75.100	75.175	75.250	75.325	75.400

SCPI command:

n.a.

Set To Default - Marker Beacon Modulation

Activates the Marker Beacon default setting. The RF frequency is set to 75 MHz.

Parameter	Value
State	Off
Marker frequency	400 Hz
Marker Depth	95 %
Pulsed Marker	Off
COM/ID State	Off
COM/ID Frequency	1020 kHz
COM/ID Period	9 s
COM/ID Depth	10 percent
Rf frequency	75 MHz

SCPI command:

[\[:SOURce\]:MBEacon:PRESet](#) on page 556

5.4.12 ADF Modulation

ADF modulation (**A**utomatic **D**irection **F**inders) is available for the basic unit (R&S SMA + frequency option R&S SMA-B10x) equipped with option R&S SMA-K25.

The ADF signal is output at the LF OUT connector at the front of the instrument.

The ADF modulation provides a predefined test signal for ADF systems (Automatic Direction Finder).

ADF receivers provide the relative bearing of a basic ground based Non Directional Beacon (NDB) to the fore/aft axis of the aircraft by using a directional antenna assembly in the aircraft. The ADF determines the direction to the NDB station relative to the aircraft

and is used for instrument approaches (autopilot). It provides additional information to other navigation equipment, e.g. VOR.

5.4.12.1 ADF Modulation Menu



The "ADF Modulation" menu is opened in the "Mod" function block or using the MENU key under Mod.

In the upper section of the menu, the modulation source is selected and the modulation switched on. The configuration of the communication/identification signal is performed in the lower section of the menu.

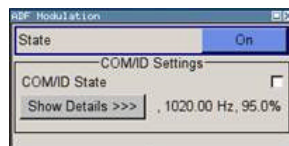

State - ADF Modulation

Activates/deactivates ADF modulation. A unmodulated carrier with a frequency of 190 kHz (default) is generated. After switching on the COM/ID tone the carrier is modulated with 95 percent AM depth at a 1,02 kHz modulation rate.

Activation of ADF modulation deactivates AM, VOR, ILS and Marker Beacon modulation. Source selection is disabled in the "LF Output" menu:

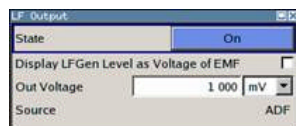

SCPI command:

[\[:SOURce\]:ADF:STATe](#) on page 454

COM/ID(A0/A2) State - ADF Modulation

Switches on/off the communication/identification signal (COM/ID signal). The COM/ID tone is modulated onto the carrier (A0/A2 transmission).

SCPI command:

[\[:SOURce\]:ADF:COMid\[:STATe\]](#) on page 453

Show Details - ADF Modulation

Reveals the detailed setting options for the COM/ID signal. Once the details are revealed, the labeling on the button changes to "Hide Details". Use this to hide the detailed setting options display again. (COM/ID signal).

SCPI command:

n.a.

COM/ID(A0/A2) Code - ADF Modulation

Enters the coding of the COM/ID signal by the international short name of the airport (e.g. MUC for the Munich airport). (COM/ID signal).

The COM/ID tone is sent according to the selected code (see table of Morse below). The length of the Morse code can be varied. For selection standard time scheme, the selected dot length determines the setting of all other length parameters of the Morse code (dash length, symbol space and letter space). For selection user time scheme, all length parameters of the code can be set independently.

The COM/ID tone is modulated onto the carrier (A0/A2 transmission).

If no coding is entered, the COM/ID tone is sent uncoded (key down).

Table 5-15: Morse Code

Letter	Morse Code	Letter	Morse Code
A	. -	N	- .
B	- . . .	O	- - -
C	- . . .	P	. - - .
D	- . .	Q	- - . -
E	.	R	. - .
F	S	. . .
G	- - .	T	-
H	U	. . -
I	. .	V	. . . -
J	. - - -	W	. - -
K	- . -	X	- . . -
L	. - . .	Y	- . - -
M	- -	Z	- - . .

Note:

The following values are default values:

- A dot (.) has a tone duration of 100 ms

- A dash (-) has a tone duration of 300ms
- The time between two tones is 100ms
- The time between two letters is 300ms

After each word a word space is entered. The word repetition rate is 7 words/minute. As the word length can vary between 900 ms and 4500 ms the word space between the words varies accordingly.

Example:

ID code = MUC

The word length =

$300+100+300+300+100+100+100+100+300+300+300+100+100+100+300+100+100 = 3100$ ms

SCPI command:

[\[:SOURce\]:ADF:COMid:CODE](#) on page 449

COM/ID(A0/A2) Frequency - ADF Modulation

Enters the frequency of the COM/ID signals.

SCPI command:

[\[:SOURce\]:ADF:COMid:FREQuency](#) on page 451

COM/ID(A0/A2) Period - ADF Modulation

Enters the period of the COM/ID signal in seconds.

SCPI command:

[\[:SOURce\]:ADF:COMid:PERiod](#) on page 452

COM/ID(A0/A2) Depth - ADF Modulation

Enters the AM modulation depth of the COM/ID signal.

SCPI command:

[\[:SOURce\]:ADF:COMid:DEPTH](#) on page 450

COM/ID(A0/A2) Time Schema - ADF Modulation

Selects if the set dot length determines the dash length (= three times the dot length) (setting Standard) or if all length parameters can be set independently (setting User). (COM/ID signal).

SCPI command:

[\[:SOURce\]:ADF:COMid:TSCHEMA](#) on page 453

COM/ID(A0/A2) Dot Length - ADF Modulation

Enters the length of a Morse dot by means of seconds. The length of the dash (3xdot), space (=dot) and letter space (=3xdot) is also determined by this entry if time scheme standard is selected.

SCPI command:

[\[:SOURce\]:ADF:COMid:DOT](#) on page 451

COM/ID(A0/A2) Dash Length - ADF Modulation

(user time schema only)

Enters the length of a Morse dash by means of seconds.

SCPI command:

`[:SOURce] :ADF:COMid:DASH` on page 450

COM/ID(A0/A2) Symbol Space - ADF Modulation

(user time schema only)

Enters the length of a symbol space by means of seconds.

SCPI command:

`[:SOURce] :ADF:COMid:SYMBOL` on page 452

COM/ID(A0/A2) Letter Space - ADF Modulation

(user time schema only)

Enters the length of a letter space by means of seconds.

SCPI command:

`[:SOURce] :ADF:COMid:LETTER` on page 451

5.5 Modulation Generator and LF Output

5.5.1 Overview of LF Generator

An LF generator providing sinusoidal and square signals in the frequency range 0.1 Hz to 1 MHz is available for the basic unit without additional equipment options.

Option Multifunction Generator, R&S SMA-K24, provides a second LF generator that can be used as a second modulation source with the frequency range of 0,1 Hz ... 10 MHz and selectable signal shapes and also as source for a noise modulation signal. In addition it extends the frequency range of the first LF generator to 0,1 Hz ... 10 MHz, also.

The internal LF generator is available as the internal source for the analog modulations AM, FM / PM and Pulse, and also as the signal source for the LF output at the rear of the instrument.

The frequency setting for the LF generator can be made both in the modulation dialogs and in the "LF Generator / Output" dialog. The settings are effective for all modulations using the internal modulation source.

A change to the frequency of the LF generator automatically has an effect on modulation if the LF generator is selected as the modulation source (i.e. "Internal" is selected as "Source").

For example, a change to the frequency of the first LF generator automatically has an effect on AM modulation if the first LF generator is selected as the AM modulation source (i.e. "Internal LFGen1" is selected as Source).

The LF Sweep mode is activated in the "LF Frequency Sweep" dialog (see [chapter 5.5.2, "LF Frequency Sweep"](#), on page 292). "RF frequency" and "RF Level" sweeps are activated in the respective dialogs of the RF block.

The option Pulse Generator (R&S SMA-K23) enables the generation of single and double pulse signals.

Option (R&S SMA-K27), Pulse Train, enables generation of pulse trains.

The generator is activated and configured in the "Pulse Generator" dialog of the "Mod Gen" block or in the "Pulse Modulation" dialog of the "Modulation" block ("Pulse Generator" is selected as "Source").

5.5.2 LF Frequency Sweep

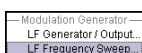

The "LF Frequency Sweep" dialog is used to activate and configure a sweep for the LF frequency.

To open the "LF Frequency Sweep" dialog, select "Mod Gen" > "Configure" > "LF Frequency Sweep" or use the MENU key under "Mod Gen".

In the top section, the LF Sweep mode is activated and the sweep mode is selected. The buttons are used to reset the LF sweep (all sweep modes) or to execute the LF sweep ("Single" mode).

The sweep range, sweep spacing and dwell time are set in the bottom of the section.

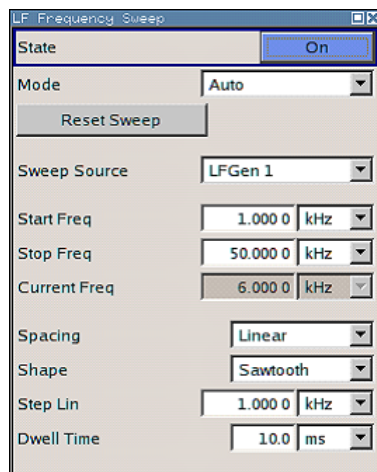

State - LF Sweep

Activates LF Sweep mode.

Note: Activating the LF frequency sweep automatically deactivates the list mode, RF level sweep and RF frequency sweep.

SCPI command:

[\[:SOURce\]:LFOutput:FREQuency:MODE](#) on page 527

Mode - LF Sweep

Selects the Sweep instrument operating mode and Sweep mode.

"Auto"	<p>Sets are automatic repeated sweep cycle. If a different sweep mode was activated prior to the "Auto" mode, the cycle continues from the current sweep setting. The "Reset Sweep" button resets the sweep to the start frequency.</p> <p>Example:</p> <pre>SOUR:LFO:SWE:FREQ:MODE AUTO TRIG0:SWE:SOUR AUTO SOUR:LFO:FREQ:MODE SWE</pre>
"Single"	<p>Sets a single sweep cycle. The sweep is triggered by the "Execute Single Sweep" button. If a different sweep mode was activated prior to the "Single" mode, the current sweep is stopped. The "Single" sweep always starts at the start frequency. The "Reset Sweep" button resets the sweep to the start frequency.</p> <p>Example:</p> <pre>SOUR:LFO:SWE:FREQ:MODE AUTO TRIG0:SWE:SOUR SING SOUR:LFO:FREQ:MODE SWE SOUR:LFO:SWE:FREQ:EXEC</pre>
"Step"	<p>Sets a step-by-step sweep cycle. Each sweep step is triggered by a variation of the value in the "Current Freq" entry window. If this mode is activated, the cursor moves to the value displayed for "Current Freq". If a different sweep mode was activated prior to the "Step" mode, the current sweep is stopped. The "Step" sweep starts at the current LF frequency. The "Reset Sweep" button resets the sweep to the start frequency.</p> <p>Example:</p> <pre>SOUR:LFO:SWE:FREQ:MODE MAN SOUR:LFO:FREQ:MODE SWE SOUR:LFO:SWE:FREQ:SPAC LIN SOUR:LFO:SWE:FREQ:STEP:LIN 1E34 SOUR:LFO:FREQ:MAN 12 kHz</pre> <p>The value entered with command SOUR:LFO:SWE:FREQ:STEP:LIN LOG sets the step width.</p> <p>The value entered with command SOUR:LFO:FREQ:MAN has no effect, the command only sets the next sweep step. In remote control only a step-by-step sweep from start to stop frequency is possible</p>

"Extern Single" Sets a single sweep cycle. The sweep is triggered by an external trigger signal.
 If a different sweep mode was activated prior to the "Extern Single" mode, the current sweep is stopped. The "Extern Single" sweep always starts at the start frequency.
 The external trigger signal is input at the BNC connector INST TRIG.
 The "Reset Sweep" button resets the sweep to the start frequency.

Example:

```
SOUR:LFO:SWE:FREQ:MODE AUTO
```

```
TRIG0:SWE:SOUR EXT
```

```
SOUR:LFO:FREQ:MODE SWE (External trigger)
```

"Extern Step" Sets a step-by-step sweep cycle. Each sweep step is triggered by an external trigger signal (trigger source as described under "Extern Single"). The step width corresponds to the step width set for the rotary knob.
 If a different sweep mode was activated prior to the "Extern Step" mode, the current sweep is stopped. The "Extern Step" sweep always starts at the LF start frequency.
 The "Reset Sweep" button resets the sweep to the start frequency.

Example:

```
SOUR:LFO:SWE:FREQ:MODE AUTO
```

```
TRIG0:SWE:SOUR EXT
```

```
SOUR:LFO:FREQ:MODE SWE (External trigger)
```

"Extern Start/Stop" Sets an automatically repeated sweep cycle that is started, stopped and restarted by subsequent external trigger events.
 The first external trigger signal starts the sweep (Start).
 The next external trigger signal stops the sweep at the current frequency (Stop).
 The third external trigger signal starts the sweep at the start frequency (Start).
 If a different sweep mode was activated prior to the "Extern Start/Stop" mode, the current sweep is stopped and the "Extern Start/Stop" sweep starts at the start frequency when triggered.
 The "Reset" button resets the sweep to the start frequency.
 The external trigger signal is input at the BNC connector INST TRIG.

Example:

```
SOUR:LFO:SWE:FREQ:MODE AUTO
```

```
TRIG0:SWE:SOUR EAUT
```

```
SOUR:LFO:FREQ:MODE SWE (External trigger)
```

SCPI command:

[\[:SOURce\]:LFOutput:SWEep\[:FREQuency\]:MODE](#) on page 531

[:TRIGger<hw>\[:SWEep\]:SOURce](#) on page 638

[\[:SOURce\]:LFOutput:FREQuency:MODE](#) on page 527

Execute Single Sweep - LF Sweep

Triggers the sweep manually. A manual sweep can only be triggered if "Mode Single" is selected.

SCPI command:

[\[:SOURce\]:LFOutput:SWEep\[:FREQuency\]:EXECute](#) on page 530

Reset Sweep - LF Sweep

Resets the sweep. The start frequency is set and the next sweep starts from there.

SCPI command:

[\[:SOURce<hw>\]:SWEep:RESet\[:ALL\]](#) on page 604

Sweep Source - LF Sweep

Selects the sweep source.

SCPI command:

[\[:SOURce\]:LFOutput:SWEep\[:FREQuency\]:LFSource](#) on page 531

Start Freq - LF Sweep

Sets the start frequency.

SCPI command:

[\[:SOURce\]:LFOutput:FREQuency:START](#) on page 528

Stop Freq - LF Sweep

Sets the stop frequency.

SCPI command:

[\[:SOURce\]:LFOutput:FREQuency:STOP](#) on page 529

Current Freq - LF Sweep

Displays the current frequency.

If "Step" is set, the frequency for the next frequency step of the sweep is entered here.

SCPI command:

[\[:SOURce\]:LFOutput:FREQuency:MANual](#) on page 527

Spacing - LF Sweep

Selects linear or logarithmic sweep spacing.

SCPI command:

[\[:SOURce\]:LFOutput:SWEep\[:FREQuency\]:SPACing](#) on page 533

Shape - LF Frequency Sweep

Selects the cycle mode for a sweep sequence (shape)

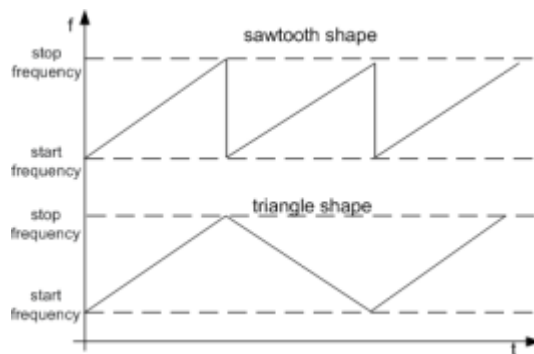

"Sawtooth" One sweep runs from start to stop frequency. Each subsequent sweep starts at the start frequency, i.e. the shape of the sweep sequence resembles a sawtooth.

"Triangle" One sweep runs from start to stop frequency and back, i.e. the shape of the sweep resembles a triangle. Each subsequent sweep starts at the start frequency.

SCPI command:

[\[:SOURCE\]:LFOutput:SWEEP\[:FREQUENCY\]:SHAPE](#) on page 533

Step Lin/Log - LF Sweep

Sets the step width for the individual sweep steps. This entry is effective for all sweep modes.

"Step Lin" or "Step Log" is displayed depending on whether "Spacing Lin" or "Log" is selected.

"Step Lin" With the linear sweep, the step width is a fixed frequency value which is added to the current frequency. The linear step width is entered in Hz.

SCPI command:

[\[:SOURCE\]:LFOutput:SWEEP\[:FREQUENCY\]:STEP\[:LINear\]](#) on page 533

"Step Log" With the logarithmic sweep, the step width is a constant fraction of the current frequency. This fraction is added to the current frequency. The logarithmic step width is entered in %.

SCPI command:

[\[:SOURCE\]:LFOutput:SWEEP\[:FREQUENCY\]:STEP:LOGarithmic](#) on page 534

Dwell Time - LF Sweep

Sets the dwell time. The dwell time determines the duration of the individual sweep steps.

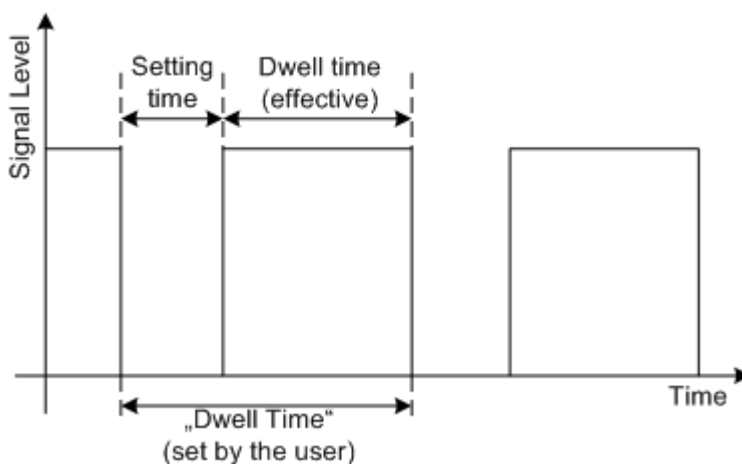

The "Dwell Time" set by the user is used as the step time of the sweep. The effective net dwell time is shorter, reduced by the setting time. This setting time may be greater than the time specified in the data sheet.

Note:

It is recommended to switch off the GUI update for optimum sweep performance especially with short dwell times (see [chapter 5.2.3.5, "Gui Update"](#), on page 88).

SCPI command:

[\[:SOURce\]:LFOutput:SWEep\[:FREQuency\]:DWELl](#) on page 530

Trigger Input Slope

Sets the polarity of the active slope of an applied instrument trigger.

This setting affects the INST TRIG input (BNC connector at the rear of the instrument).

"Positive" The rising edge of the trigger signal is active.

"Negative" The falling edge of the trigger signal is active.

SCPI command:

[\[:SOURce\]:INPut:TRIGger:SLOPe](#) on page 525

5.5.3 LF Output

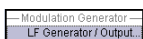

To open the "LF Generator / Output" dialog, select "Mod Gen" > "Configure" > "LF Generator / Output" or use the MENU key under "Mod Gen".

The "LF Output" dialog provides access to the configuration of the internal modulation generators. In addition, the LF output is configured in this menu. The available settings depend on the source selected and on the installed options.

In the upper section of the menu, the LF output source is selected and the LF output is switched on. The source can be selected independently for the different modulations and the LF output. The configuration of the selected internal source is performed in the lower section of the "LF Output" menu or in the individual modulation menus of the "Mod" block (e.g. "Amplitude Modulation" menu). These settings affect all modulations which use the same modulation sources and the LF output. For a fully equipped instrument two LF generators and a noise generator are available as internal sources.

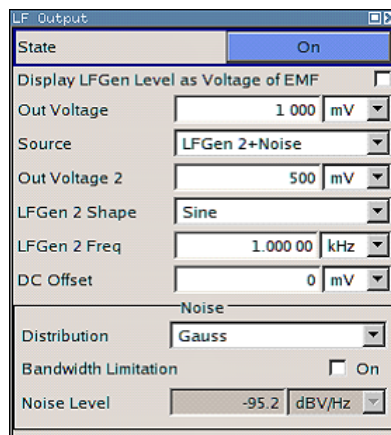

5.5.3.1 LF Output Dialog

State - LF Output

Activates/deactivates the LF output. This setting has no effect on the modulations. The modulation signal is output at the LF OUTPUT connector of the instrument.

SCPI command:

[\[:SOURce\]:LFOutput\[:STATe\]](#) on page 530

Output Voltage - LF Output

Sets the output voltage of the LF output. The entered value determines the peak voltage.

SCPI command:

[\[:SOURce\]:LFOutput:VOLTage](#) on page 536

Source

Selects the internal source to be used for the LF Output signal. The available selection depends on the options fitted.

Note: VOR/ILS is indicated and selecting the source is disabled if VOR/ILS modulation is activated.

Note: If an avionic modulation (VOR/ILS) is activated all settings except for the output voltage are disabled and the avionic modulation is indicated under "Source".

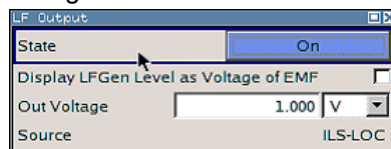

In order to enable source selection again, the avionic modulation must be deactivated first.

- | | |
|---------------------|---|
| "None" | Switches off all internal modulation sources. |
| "LFGGen1 / LFGGen2" | Selects one of the internal LF generators as the source for the LF Output signal. |

"LFGGen1+2"	Selects both internal LF generators as the source for the LF Output signal. LF frequency and output voltage can be set separately for the two LF generators. The added output voltage of the two modulation generators must not exceed the overall voltage.
"Noise"	Selects the internal noise signal. The LF output signal is white noise either with Gaussian distribution or equal distribution. See also chapter 5.5.3.2, "Noise Settings" , on page 300.
"LFGGen1+Noise / LFGGen2+Noise"	Selects one LF generator and the noise signal as the source for LF Output.

SCPI command:

[\[:SOURce<hw>\]:AM:INTernal:SOURce](#) on page 455

Output Voltage 1/2 - LF Output

(Source LFGGen1+2 only)

Selects the output voltage for the two LF generators. The sum of the two values must not exceed the overall output voltage set in the upper part of the menu.

SCPI command:

[\[:SOURce\]:LFOutput<ch>:INTernal:VOLtTage](#) on page 529

LF Gen 1/2 Freq - LF Output

(Source LFGGen1+2 only)

Sets the frequency of the two LF generators.

This setting affects all analog modulations which use the LF generator as the internal modulation source.

Note: VOR/ILS is indicated and setting the frequency is disabled if VOR/ILS modulation is activated.

SCPI command:

[\[:SOURce\]:LFOutput<ch>:FREQuency](#) on page 526

LF Gen Shape

Selects the waveform shape of the LF signal.

The settings applies for "Source LFGGen2" only. In case of selection "Trapeze" additional settings concerning the duration of the single trapeze elements can be made.

SCPI command:

[\[:SOURce\]:LFOutput<ch>:SHAPE](#) on page 535

Trapeze Rise - LF Output

(Source LFGGen2 only)

Selects the rise time for the trapeze shape of the second LF generator.

SCPI command:

[\[:SOURce\]:LFOutput<ch>:SHAPE:TRAPEze:RISE](#) on page 536

Trapeze High - LF Output

(Source LFGen2 only)

Selects the high time for the trapeze shape of the second LF generator.

SCPI command:

[\[:SOURce\]:LFOutput<ch>:SHAPE:TRAPeZe:HIGH](#) on page 535**Trapeze Fall - LF Output**

(Source LFGen2 only)

Selects the fall time for the trapeze shape of the second LF generator.

SCPI command:

[\[:SOURce\]:LFOutput<ch>:SHAPE:TRAPeZe:FALL](#) on page 535**Trapeze Low - LF Output**

(Source LFGen2 only)

Selects the low time for the trapeze shape of the second LF generator.

SCPI command:

[\[:SOURce\]:LFOutput<ch>:SHAPE:TRAPeZe:LOW](#) on page 536**DC Offset - LF Output**

Sets a DC offset at the LF Output.

SCPI command:

[\[:SOURce\]:LFOutput:OFFSet](#) on page 529**5.5.3.2 Noise Settings**

The settings for the noise source are offered in the "Noise" section of the "LF Output" menu of the "Mod Gen" block. This setting affects all analog modulations which use the noise generator as the internal modulation source

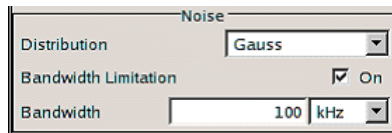
**Distribution - Noise**

Source Internal, Noise only

Selects the noise power density distribution of noise.

"Gaussian" The noise power density has a Gaussian distribution.

"Equal" The noise power density has an even distribution.

SCPI command:

[\[:SOURce<hw>\]:NOISe:DISTriBution](#) on page 559**Bandwidth Limitation**

Source Internal, Noise only

Enabled /disables bandwidth limitation of noise.

- "On" The noise signal is generated within the set frequency bandwidth. The noise level in the frequency band is indicated at "[Noise Level \(System Bandwidth\)](#)" ("LF Output" menu of the "Mod Gen" block).
- "Off" The noise signal is generated within the maximum bandwidth of 10 MHz. The noise level per Hz is indicated at "[Noise Level - Noise](#)" ("LF Output" menu of the "Mod Gen" block)

SCPI command:

[\[:SOURce<hw>\]:NOISe:BWIDth:STATe](#) on page 558

Noise Level - Noise

Indicates the level of the noise signal per Hz in the total bandwidth.

SCPI command:

[\[:SOURce<hw>\]:NOISe:LEVel:RELative?](#) on page 559

Bandwidth

Source Internal, Noise only

Enters the noise bandwidth in case bandwidth limitation is enabled. Distinct bandwidth settings between 10 kHz and 10 MHz in 100 kHz steps (range 100 .. 1 MHz), 1 MHz (range 1 MHz .. 5 MHz) and 5 MHz (5 MHz ... 10 MHz) are possible.

The noise signal is generated within the set frequency bandwidth. Noise level per Hz and noise level in the system bandwidth are indicated at "[Noise Level \(System Bandwidth\)](#)" ("LF Output" menu of the "Mod Gen" block).

SCPI command:

[\[:SOURce<hw>\]:NOISe:BWIDth](#) on page 558

Noise Level (System Bandwidth)

Indicates the noise level in the system bandwidth for enabled bandwidth limitation. Distinct bandwidth settings between 10 kHz and 10 MHz in 100 kHz steps are possible.

SCPI command:

[\[:SOURce<hw>\]:NOISe:LEVel\[:ABSolute\]?](#) on page 559

5.5.4 Pulse Generator

The "Pulse Generator" dialog is used to activate and configure a pulse modulation signal.

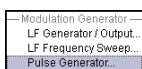

To open the "Pulse Generator" dialog, select "Mod Gen" > "Configure" > "Pulse Generator" or use the MENU key under "Mod gen". Alternatively, you can configure the pulse generator in the "Pulse Modulation" dialog of the "Modulation" block.

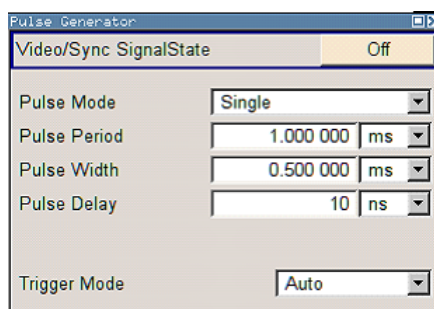

5.5.4.1 Pulse Generator Settings

The dialog provides the settings for the pulse characteristics and trigger mode.

Video Sync Signal State - Pulse Generator

Switches on/off the output of the video/sync signal at the PULSE VIDEO connector. The signal output and the pulse generator are automatically switched on with activation of pulse modulation if pulse generator is selected as modulation source. The signal output can be switched off subsequently.

SCPI command:

`[:SOURce<hw>] : PGEN : STATe` on page 560

Pulse Mode - Pulse Generator

Sets the mode of the pulse generator.

- "Single" A single pulse is generated in one pulse period.
- "Double" Two pulses are generated in one pulse period. Additional settings for the double pulse are available in the menu.
- "Train" Requires option R&S SMA-K27.
A user-defined pulse train is generated. Additional settings for the pulse train are available in the menu after selection of the pulse train mode (see [chapter 5.5.4.2, "Pulse Train Generation"](#), on page 307).
A pulse train is a sequence of pulses with user-defined on and off times. The ontime/offtime value pairs are defined in a pulse train list. The currently used pulse train file is displayed in the sub menu.

SCPI command:

`[:SOURce<hw>] : PULM : MODE` on page 579

Pulse Period - Pulse Generator

Sets the period of the generated pulse. The period determines the repetition frequency of the internal signal.

SCPI command:

`[:SOURce<hw>] : PULM : PERiod` on page 579

Pulse Width - Pulse Generator

Sets the width of the generated pulse. The width determines the pulse length. The pulse width must be at least 20 ns less than the set pulse period.

SCPI command:

[:SOURce<hw>] :PULM:WIDTh on page 591

Pulse Delay - Pulse Generator

(External trigger only)

Sets the pulse delay. The pulse delay determines the time that elapses after a trigger event before pulse modulation starts. The pulse delay is not effective for double pulse generation.

SCPI command:

[:SOURce<hw>] :PULM:DELay on page 577

Double Pulse Width - Pulse Generator

(Double Pulse only)

Sets the width of the second pulse.

SCPI command:

[:SOURce<hw>] :PULM:DOUBle:WIDTh on page 578

Double Pulse Delay - Pulse Generator

(Double Pulse only)

Sets the delay from the start of the first pulse to the start of the second pulse.

SCPI command:

[:SOURce<hw>] :PULM:DOUBle:DELay on page 578

Trigger Mode - Pulse Generator

Selects the trigger mode for pulse modulation.

"Auto" The pulse generator signal is generated continuously.

"Ext Triggered" The pulse generator signal is triggered by an external trigger event. The trigger signal is supplied via the PULSE EXT connector.

Example: Generation of pulse signals using trigger modes Ext Triggered (Single Pulse)

The measurement were made using a 6-dB-attenuator.

Parameter	Value
Trigger Mode	Ext Triggered
Double Pulse State	Off
External Trigger Input Slope	Positive
Pulse Delay	100 ns
Pulse Width	100 ns
Pulse Period	-

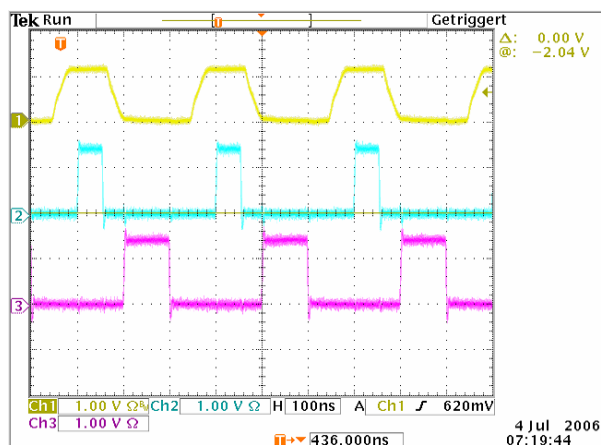

Channel 1 = Indicates the external trigger signal which is input at the PULSE EXT connector. The positive slope is active.

Channel 2 = Indicates the sync signal. The sync signal starts after a trigger delay of typically 50 ns (see specifications). The sync signal is output at the PULSE SYNC connector.

Channel 3 = Indicates the pulse signal. The pulse signal starts after the set pulse delay of 100 ns. It is output at the PULSE VIDEO connector.

Example: Generation of pulse signals using trigger modes Ext Triggered (Double Pulse)

The measurement were made using a 6-dB-attenuator.

Parameter	Value
Trigger Mode	Ext Triggered
Double Pulse State	On
External Trigger Input Slope	Negative
Pulse Width	100 ns
Double Pulse Width	100 ns

Parameter	Value
Double Pulse Delay	200 ns
Pulse Period, Pulse Delay	-

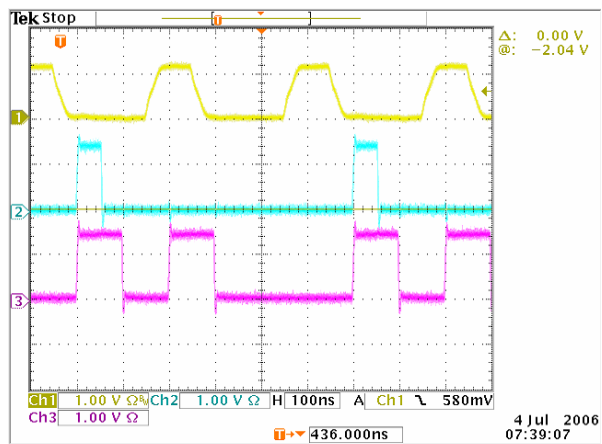

- Chan- = Indicates the external trigger signal which is input at the PULSE EXT connector. The negative slope is active. A second trigger signal during double pulse generation is without effect.
- nel 1
- Chan- = Indicates the sync signal. The sync signal starts after a trigger delay of typically 50 ns (see specifications). The sync signal is output at the PULSE SYNC connector.
- nel 2
- Chan- = Indicates the double pulse signal. The first pulse starts without a delay. The second pulse starts after the set double pulse delay (time between start of first pulse to start of second pulse). The double pulse is output at the PULSE VIDEO connector.
- nel 3

"Ext Gated" The pulse generator signal is gated by an external gate signal. The signal is supplied via the PULSE EXT connector.

Example: Generation of pulse signals using trigger modes Ext gated (Single Pulse)

The measurement were made using a 6-dB-attenuator.

Parameter	Value
Trigger Mode	Ext Gated
Double Pulse State	Off
External Trigger Input Slope	Positive
Pulse Delay	100 ns
Pulse Width	100 ns
Pulse Period	300 ns

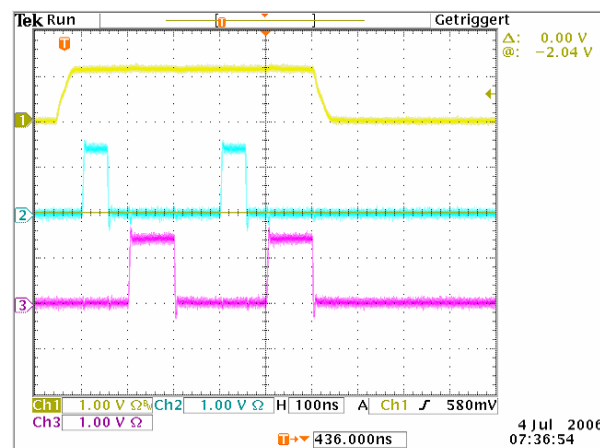

Chan- = Indicates the external gate signal which is input at the PULSE EXT connector.
 nel 1 The signal is active when it is high (positive).
 Chan- = Indicates the sync signal. The sync signal starts after a trigger delay of typically
 nel 2 50 ns (see specifications). It is repeated after the set pulse period of 300 ns
 as long as the gate signal is active. The sync signal is output at the (PULSE)
 SYNC connector.
 Chan- = Indicates the pulse signal. The first pulse starts after the pulse delay of 100
 nel 3 ns. The second pulse starts after the set pulse period. They are output at the
 (PULSE) VIDEO connector.

SCPI command:

[:SOURce<hw>] :PULM:TRIGger:MODE on page 587

External Trigger Input Slope - Pulse Generator

(External Trigger only)

Sets the polarity of the active slope of an applied trigger signal.

"Positive" The pulse generator is triggered on the positive slope of the external trigger signal.

"Negative" The pulse generator is triggered on the negative slope of the external trigger signal.

SCPI command:

`[:SOURce<hw>] :PULM:TRIGger:EXTernal:SLOPe` on page 586

Gate Input Polarity - Pulse Generator

(Trigger Mode External Gated only)

Selects the polarity of the Gate signal.

The signal is supplied via the PULSE EXT connector.

"Normal" The pulse signal is generated while the gate signal is high.

"Inverse" The pulse signal is generated while the gate signal is low.

SCPI command:

`[:SOURce<hw>] :PULM:TRIGger:EXTernal:GATE:POLarity` on page 586

Pulse External Input Impedance

Selects the input impedance (10 kOhm or 50 Ohm) for the external trigger and gate signal input (PULSE EXT).

SCPI command:

`[:SOURce<hw>] :PULM:TRIGger:EXTernal:IMPedance` on page 586

5.5.4.2 Pulse Train Generation

Upon selection of mode pulse train the menu is extended for configuring a user-defined pulse train.

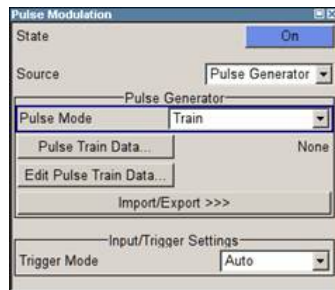

A pulse train is a sequence of pulses with user-defined on and off times. The ontime/offtime value pairs are defined in a pulse train list. The currently used pulse train file is displayed in the sub menu.

An internally created pulse train list can be exported or externally created list can be imported.

Pulse Train Data – Pulse Generator

Calls the "File Select" menu for selecting and creating a pulse train file or to open the "File Manager".

SCPI command:

`[:SOURce<hw>] :PULM:TRAI:n:CATalog?` on page 581

`[:SOURce<hw>] :PULM:TRAI:n:SElect` on page 585

`[:SOURce<hw>] :PULM:TRAI:n:DElete` on page 582

Edit Pulse Train Data – Pulse Generator

Calls the [Pulse Train Dialog](#).

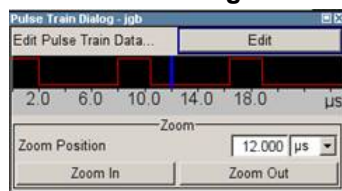
Pulse Train Dialog

The pulse train defined by the selected file is displayed.

The display of the pulse train can be zoomed, the zoom center is defined by the blue marker.

"Edit" Calls the [Edit Pulse Train Data](#) dialog for editing the pulse train.

"Zoom Position" Positions the blue marker in the pulse train. The marker defines the center of any zoom in or zoom out action.

"Zoom In/Out" Zooms in or out the graphical display of the pulse train. The zoom factor of each zoom action is 2.

Edit Pulse Train Data

(For Pulse Mode Train only)

Calls the editor for editing the ontime/offtime values of the selected file. A file consists of any number of ontime/offtime value pairs. The currently selected file is displayed.

	ON-Time/µs	OFF-Time/µs	Count
1	2.000	6.000	1
2	2.400	6.000	2
3			

"On-time/µs" Sets the ontime of the ontime/offtime value pair.

SCPI command:

`[:SOURce<hw>] :PULM:TRAI:n:ONTime` on page 583

"Off-time/µs" Sets the offtime of the ontime/offtime value pair.

SCPI command:

`[:SOURce<hw>] :PULM:TRAI:n:OFFTime` on page 582

"Count" Sets the number of repetitions for each ontime/offtime value pair.

SCPI command:

[\[:SOURce<hw>\]:PULM:TRAI:n:REPetition](#) on page 584

"Goto" Selects row for editing.

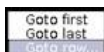

If Goto row is selected, a window opens for entering the requested row.



(it is not possible to change individual positions of the list)

"Edit" Calls a selection of possible actions described below.



"Insert Row" Insert a new row before the marked row.

"Insert Range" Insert new rows before the marked row. The number of rows to be inserted can be defined in an entry window.



"Fill...." Opens a sub menu for defining a set of list values to be automatically entered in the list.

The start line and the number of rows to be filled are defined under "From" and "Range".

The column to be filled is selected under "Select column to fill". Depending on the selection here, the default for start, end, and increment value are set. As the settings are interdependent, a change of one parameter may result in the automatic change of one or more of the other parameters.

The filling of the column with the selected value settings is started with button "Fill".

"Delete Row" Deletes the marked row.

"Delete Range" Deletes the selected number of rows including the marked row. The number of rows to be inserted can be defined in an entry window.

"Save As" Open the file menu to save the list under a new name. Each list is saved to the CompactFlash™ card as a separate file with the file prefix *.pulstrn. The file name and the directory to which the file is saved are user-selectable.

"Save" The list is saved under its current name.

Import/Export - Pulse Train Mode

Expands the menu with the area for import and export of pulse train files.

Externally edited Excel tables with on/off time and repetition triplets can be imported as text files or CSV files and used for pulse train mode.

On the other hand, internally created pulse train lists can be exported as text files or CSV files.

Mode – Import/Export Pulse Train Files

Selects if pulse train lists should be imported or exported. The settings offered below depend on the selected mode.

SCPI command:

`[:SOURce<hw>] :PULM:TRAI:n:DEXChange:MODE` on page 590

Extension – ASCII File Settings

Selects the file extension of the ASCII file to be imported or exported. Selection TXT (text file) or CSV (Excel file) is available.

SCPI command:

`[:SOURce<hw>] :PULM:TRAI:n:DEXChange:AFILe:EXTension` on page 588

Decimal Point - ASCII File Settings

Selects the decimal separator used in the ASCII data between '.' (decimal point) and ',' (comma) with floating-point numerals.

SCPI command:

`[:SOURce<hw>] :PULM:TRAI:n:DEXChange:AFILe:SEParator:DECimal`
on page 589

Column Separator- ASCII File Settings

Selects the separator between the frequency and level column of the ASCII table.

SCPI command:

`[:SOURce<hw>] :PULM:TRAI:n:DEXChange:AFILe:SEParator:COLumn`
on page 589

Select ASCII Source / Destination - Import/Export Pulse Train Files

Calls the "File Manager" for selecting the ASCII file to be imported into a pulse train list (source) or the ASCII file the pulse train list is exported (destination) in.

SCPI command:

`[:SOURce<hw>] :PULM:TRAI:n:DEXChange:AFILe:CATalog?` on page 587

`[:SOURce<hw>] :PULM:TRAI:n:DEXChange:AFILe:SELeCt` on page 588

Select Destination / Source - Import/Export Pulse Train Files

Calls the "File Manager" for selecting the pulse train list to be exported (source) into an ASCII file or the destination for the ASCII file to be imported (destination) in.

SCPI command:

`[:SOURce<hw>] :PULM:TRAI:n:DEXChange:SELeCt` on page 591

Import / Export - Import/Export Pulse Train Files

Starts the export or import of the selected file.

If import is selected, the ASCII file is imported as pulse train list.

If export is selected, the pulse train list is exported into the selected ASCII file.

SCPI command:

[:SOURce<hw>] :PULM:TRAI:n:DEXChange:EXECute on page 590

5.6 Clock Synthesis

The clock synthesis provides a separate system clock with a freely selectable frequency for test setups that require an additional clock reference. For example, in a test setup that uses an A/D converter the required system clock for data sampling can be provided without the need of additional signal generator.

The generated clock reference is synchronized to the selected reference clock of the signal generator (internal or external). The differential signal is output at the "CLK SYN" and "CLK SYN N" connector at the rear of the instrument.

Settings are made in the "Clock Synthesis" block. The function block is available for the basic unit (R&S SMA + frequency option R&S SMA-B10x) including option R&S SMA-B29.

5.6.1 Clock Synthesis Dialog

To access the "Clock Synthesis" dialog, select the "Clock Synthesis" function block or use the MENU key under "Clock Synthesis".

The clock signal can be activated and deactivated directly using the TOGGLE ON/OFF key (the function block must be highlighted beforehand).

The activated and deactivated state is indicated in the block diagram by means of the different block color and the status of the "On" checkbox. The disconnected connection to the output is additionally shown when the output is deactivated.

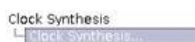

The Clock Synthesis state can also be set in the "Configure" menu of the block:

The clock synthesis state is activated and frequency is set in the top section of the menu.

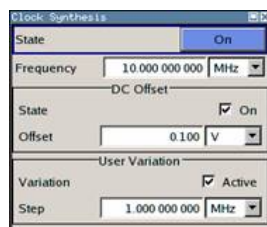

The step width which is used when setting the clock frequency using the rotary knob (with "Variation Active On") is set in the "User Variation" section.

5.6.1.1 Clock Synthesis general Settings

State - Clock Synthesis

Activates/deactivates generation of a system clock for output CLK SYN at the rear of the instrument .

SCPI command:

`:CSYNthesis:STATe` on page 364

Frequency - Clock Synthesis

Sets the frequency. The frequency entered and displayed here corresponds to the frequency at the CLK SYN output.

SCPI command:

`:CSYNthesis:FREQuency` on page 363

5.6.1.2 DC Offset

A DC offset can be defined in the "DC Offset" section.

State DC Offset - Clock Synthesis

Requires modules with part number 1400.2749.02 (see "Setup" menu).

Activates a DC offset for both clock synthesis signal outputs.

The DC offset can be used e.g. to shift the clock synthesis output signal into the trigger threshold of some logic elements.

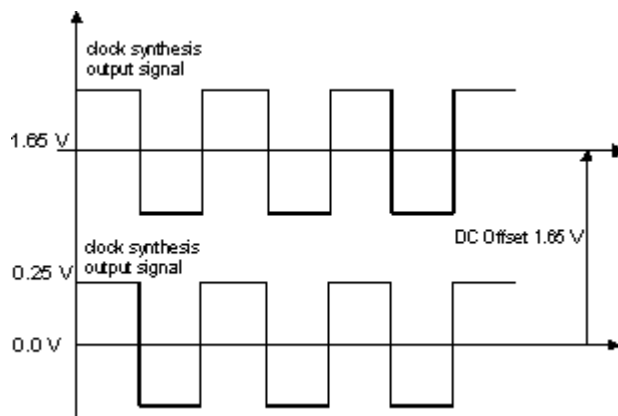

SCPI command:

`:CSYNthesis:OFFSet:STATe` on page 365

DC Offset - Clock Synthesis

Requires modules with order number 1400.2749.02 (see "Setup" menu).

Enters the value of the DC offset for both clock synthesis signal outputs.

SCPI command:

`:CSYNthesis:OFFSet` on page 365

5.6.1.3 User Variation

If the clock frequency is set using the rotary knob, the step width is defined in the "User Variation" section.

Variation Step - Clock Synthesis

Sets the user-defined step width. This step width is used when entering the clock frequency using the rotary knob. Frequency variation with this step width must also be activated with "Variation Active".

SCPI command:

`:CSYNthesis:FREQuency:STEP` on page 364

Variation Active

Activates the user-defined step width used when varying the frequency value with the rotary knob.

- | | |
|-------|---|
| "ON" | The frequency value set with the rotary knob is varied using the user-defined step width which is entered under "Variation Step". |
| "OFF" | The frequency value set with the rotary knob is varied in steps of one unit at the cursor position (standard operating mode). |

SCPI command:

`:CSYNthesis:FREQuency:STEP:MODE` on page 365

6 Remote Control Basics

This chapter provides basic information on operating an instrument via remote control.

6.1 Remote Control Interfaces and Protocols

The instrument supports different interfaces for remote control. The following table gives an overview.

Table 6-1: Remote control interfaces and protocols

Interface	Protocols, VISA ^{*)} address string	Remarks
Local Area Network (LAN)	Protocols: <ul style="list-style-type: none"> HiSLIP High-Speed LAN Instrument Protocol (IVI-6.1) VISA^{*)} address string: TCPIP::host address:: hislip0[::INSTR] VXI-11 VISA^{*)} address string: TCPIP::host address[:: LAN device name]::INSTR socket communication (Raw Ethernet, simple telnet) VISA^{*)} address string: TCPIP::host address[:: LAN device name]::<port>:: SOCKET 	A LAN connector is located on the front or rear panel of the instrument, or both. The interface is based on TCP/IP and supports various protocols. For a description of the protocols refer to: <ul style="list-style-type: none"> chapter 6.1.3.1, "HiSLIP Protocol", on page 317 chapter 6.1.3.2, "VXI-11 Protocol", on page 318 chapter 6.1.3.3, "Socket Communication", on page 318
Serial Interface	VISA ^{*)} address string: ASRL[0-9][::INSTR]	For a description of the interface refer to chapter 6.1.5, "Serial Interface" , on page 319.
GPIB (IEC/IEEE Bus Interface)	VISA ^{*)} address string: GPIB::primary address[::INSTR] (no secondary address)	Optional GPIB bus interfaces according to standard IEC 625.1/IEEE 488.1 are located on the rear panel of the instrument. For a description of the interface refer to chapter 6.1.6, "GPIB Interface (IEC/IEEE Bus Interface)" , on page 320.

^{*)} VISA is a standardized software interface library providing input and output functions to communicate with instruments. A VISA installation on the controller is a prerequisite for remote control over LAN (when using VXI-11 or HiSLIP protocol), USB and serial interface. However, no VISA installation is necessary to remote control while using socket communication. For more information, see [chapter 6.1.1, "VISA Libraries"](#), on page 315.



Within this interface description, the term GPIB is used as a synonym for the IEC/IEEE bus interface.

SCPI (Standard Commands for Programmable Instruments)

SCPI commands - messages - are used for remote control. Commands that are not taken from the SCPI standard follow the SCPI syntax rules. The instrument supports the SCPI version 1999. The SCPI standard is based on standard IEEE 488.2 and aims at the standardization of device-specific commands, error handling and the status registers. The tutorial "Automatic Measurement Control - A tutorial on SCPI and IEEE 488.2" from

John M. Pieper (R&S order number 0002.3536.00) offers detailed information on concepts and definitions of SCPI.

Tables provide a fast overview of the bit assignment in the status registers. The tables are supplemented by a comprehensive description of the status registers.

6.1.1 VISA Libraries

VISA is a standardized software interface library providing input and output functions to communicate with instruments. The I/O channel (LAN or TCP/IP, USB, GPIB,...) is selected at initialization time by means of the channel-specific address string ("VISA resource string"), or by an appropriately defined VISA alias (short name). A VISA installation is a prerequisite for remote control using the following interfaces:

- [chapter 6.1.3, "LAN Interface"](#), on page 316
- [chapter 6.1.3.2, "VXI-11 Protocol"](#), on page 318
- [chapter 6.1.4, "USB Interface"](#), on page 319
- [chapter 6.1.6, "GPIB Interface \(IEC/IEEE Bus Interface\)"](#), on page 320
- [chapter 6.1.5, "Serial Interface"](#), on page 319

For more information about VISA refer to the user documentation.

6.1.2 Messages

The messages transferred on the data lines are divided into the following categories:

- **Interface messages**
Interface messages are transmitted to the instrument on the data lines, with the attention line being active (LOW). They are used to communicate between the controller and the instrument. Interface messages can only be sent by instruments that have GPIB bus functionality. For details see the sections for the required interface.
- **Instrument messages**
Instrument messages are employed in the same way for all interfaces, if not indicated otherwise in the description. Structure and syntax of the instrument messages are described in [chapter 6.3, "SCPI Command Structure"](#), on page 334. A detailed description of all messages available for the instrument is provided in the chapter "Remote Control Commands".
There are different types of instrument messages, depending on the direction they are sent:
 - Commands
 - Instrument responses

Commands

Commands (program messages) are messages the controller sends to the instrument. They operate the instrument functions and request information. The commands are subdivided according to two criteria:

- According to the effect they have on the instrument:

- **Setting commands** cause instrument settings such as a reset of the instrument or setting the frequency.
- **Queries** cause data to be provided for remote control, e.g. for identification of the instrument or polling a parameter value. Queries are formed by directly appending a question mark to the command header.
- According to their definition in standards:
 - **Common commands:** their function and syntax are precisely defined in standard IEEE 488.2. They are employed identically on all instruments (if implemented). They refer to functions such as management of the standardized status registers, reset and self test.
 - **Instrument control commands** refer to functions depending on the features of the instrument such as frequency settings. Many of these commands have also been standardized by the SCPI committee. These commands are marked as "SCPI compliant" in the command reference chapters. Commands without this SCPI label are device-specific, however, their syntax follows SCPI rules as permitted by the standard.

Instrument responses

Instrument responses (response messages and service requests) are messages the instrument sends to the controller after a query. They can contain measurement results, instrument settings and information on the instrument status.

6.1.3 LAN Interface

To be integrated in a LAN, the instrument is equipped with a LAN interface, consisting of a connector, a network interface card and protocols. For remote control via a network, the PC and the instrument must be connected via the LAN interface to a common network with TCP/IP network protocol. They are connected using a commercial RJ45 cable. The TCP/IP network protocol and the associated network services are preconfigured on the instrument. Software for instrument control and (for specified protocols only) the VISA program library must be installed on the controller.

VISA library

Instrument access via VXI-11 or HiSLIP protocols is usually achieved from high level programming platforms using VISA as an intermediate abstraction layer. VISA encapsulates the low level VXI or GPIB function calls and thus makes the transport interface transparent for the user. See [chapter 6.1.1, "VISA Libraries"](#), on page 315 for details.

IP address

Only the IP address or the computer name (LAN device name) is required to set up the connection. The IP address/computer name is part of the "visa resource string" used by the programs to identify and control the instrument.

Forms of the VISA resource string:

```
TCPIP::host address[::LAN device name][::INSTR]
```

or

```
TCPIP::host address::port::SOCKET
```

where

- **TCPIP** designates the network protocol used
- **host address** is the IP address or host name of the device
- **LAN device name** defines the protocol and the instance number of a sub-instrument:
 - `inst0` selects the VXI-11 protocol (optional, default)
 - `hislip0` selects the newer HiSLIP protocol
- **INSTR** indicates the instrument resource class (optional)
- **port** determines the used port number
- **SOCKET** indicates the raw network socket resource class

Example:

- Instrument has the IP address `192.1.2.3`; the valid resource string using VXI-11 protocol is:

```
TCPIP::192.1.2.3::INSTR
```
- The DNS host name name is `RSSM1`; the valid resource string is:

```
TCPIP::RSSM1::hislip0 (HiSLIP)
```

```
TCPIP::RSSM1::INSTR (VXI-11)
```
- A raw socket connection can be established using:

```
TCPIP::192.1.2.3::5025::SOCKET
```



Identifying instruments in a network

If several instruments are connected to the network, each instrument has its own IP address and associated resource string. The controller identifies these instruments by means of the resource string.

6.1.3.1 HiSLIP Protocol

The HiSLIP (**H**igh **S**peed **L**AN **I**nstrument **P**rotocol) is the successor protocol for VXI-11 for TCP-based instruments specified by the IVI foundation. The protocol uses two TCP sockets for a single connection - one for fast data transfer, the other for non-sequential control commands (e.g. `Device Clear` or `SRQ`).

HiSLIP has the following characteristics:

- High performance as with raw socket network connections
- Compatible IEEE 488.2 support for Message Exchange Protocol, Device Clear, Serial Poll, Remote/Local, Trigger, and Service Request
- Uses a single IANA registered port (4880), which simplifies the configuration of firewalls
- Supports simultaneous access of multiple users by providing versatile locking mechanisms
- Usable for IPv6 or IPv4 networks



Note that HiSLIP data is sent to the device using the "fire and forget" method with immediate return, as opposed to VXI-11, where each operation is blocked until a VXI-11 device handshake returns. Thus, a successful return of a VISA operation such as `viWrite()` does not guarantee that the instrument has finished or started the requested command, but is delivered to the TCP/IP buffers.

6.1.3.2 VXI-11 Protocol

The VXI-11 standard is based on the ONC RPC (Open Network Computing Remote Procedure Call) protocol which in turn relies on TCP/IP as the network/transport layer. The TCP/IP network protocol and the associated network services are preconfigured. TCP/IP ensures connection-oriented communication, where the order of the exchanged messages is adhered to and interrupted links are identified. With this protocol, messages cannot be lost.

6.1.3.3 Socket Communication

An alternative way for remote control of the software is to establish a simple network communication using sockets. The socket communication, also referred as "Raw Ethernet communication", does not necessary require a VISA installation on the remote controller side.

The simplest way to establish socket communication is to use the built-in telnet program. The telnet program is part of every operating system and supports a communication with the software on a command-by-command basis. For better utilization and to enable automation by means of programs, user defined sockets can be programmed.

Socket connections are established on a specially defined port. The socket address is a combination of the IP address or the host name of the instrument and the number of the port configured for remote-control. All R&S Signal Generator use port number 5025 for this purpose. The port is configured for communication on a command-to-command basis and for remote control from a program.

6.1.3.4 LAN Interface Messages

In the LAN connection, the interface messages are called low-level control messages. These messages can be used to emulate interface messages of the GPIB bus.

Command	Long term	Effect on the instrument
&ABO	Abort	Aborts processing of the commands just received.
&DCL	Device Clear	Aborts processing of the commands just received and sets the command processing software to a defined initial state. Does not change the instrument setting.
>L	Go to Local	Transition to the "local" state (manual control).
>R	Go to Remote	Transition to the "remote" state (remote control).

Command	Long term	Effect on the instrument
&GET	Group Execute Trigger	Triggers a previously active instrument function (e.g. a sweep). The effect of the command is the same as with that of a pulse at the external trigger signal input.
&LLO	Local Lockout	Disables switchover from remote control to manual control by means of the front panel keys.
&NREN	Not Remote Enable	Enables switchover from remote control to manual operation by means of the front panel keys
&POL	Serial Poll	Starts a serial poll.

6.1.4 USB Interface

For remote control via the USB connection, the PC and the instrument must be connected via the USB type B interface. A USB connection requires the VISA library to be installed. VISA detects and configures the R&S instrument automatically when the USB connection is established. You do not have to enter an address string or install a separate driver.

USB address

The used USB address string is:

```
USB::::<product ID>::::[::INSTR]
```

where:

- <vendor ID> is the vendor ID for Rohde&Schwarz
- <product ID> is the product ID for the R&S instrument
- <serial number> is the individual serial number on the rear of the instrument

Example:

```
USB::0x0AAD::0x0048::100001::INSTR
```

0x0AAD is the vendor ID for Rohde&Schwarz

0x48 is the product ID for the R&S SMA

100001 is the serial number of the particular instrument

6.1.5 Serial Interface

Remote control via the serial interface is possible either via RS232 interface or via a Bluetooth connection. The controller/Bluetooth device and the instrument must be connected via an external USB/serial-adaptor (see recommended extras, data sheet) and a serial crossover (null modem) cable. A USB connection requires the VISA library to be installed on the controller. VISA will detect and configure the R&S SMA automatically when the USB connection is established.

Serial address

The used serial address string is:

ASRL[0-9] [: : INSTR]

where ASRL[0-9] determines the number of the COM port on the controller side, that has to be used for the serial connection.

Access via a bluetooth device requires the entry of the bluetooth pin in addition (see [chapter 5.2.3.15, "Security"](#), on page 98).

To enable an error-free and correct data transmission, the parameters of the generator and the controller must have the same setting. The serial interface is preset for a baud rate 115200, no parity and one stop bit. The parameters can be manually changed in "Remote Channel Settings" dialog (see [chapter 5.2.3.13, "Remote Channel Settings"](#), on page 94).

6.1.6 GPIB Interface (IEC/IEEE Bus Interface)

To be able to control the instrument via the GPIB bus, the instrument and the controller must be linked by a GPIB bus cable. A GPIB bus card, the card drivers and the program libraries for the programming language used must be provided in the controller. The controller must address the instrument with the GPIB bus address (see [chapter 6.1.6.2, "GPIB Instrument Address"](#), on page 321).

Characteristics

The GPIB interface is described by the following characteristics:

- Up to 15 instruments can be connected
- The total cable length is restricted to a maximum of 15 m; the cable length between two instruments should not exceed 2m.
- A wired "OR"-connection is used if several instruments are connected in parallel, since the slowest instrument determines the speed.



Any connected IEC bus cable must be terminated by an instrument or controller.

6.1.6.1 GPIB Interface Messages

Interface messages are transmitted to the instrument on the data lines, with the attention line (ATN) being active (LOW). They are used for communication between the controller and the instrument and can only be sent by a computer which has the function of a GPIB bus controller. GPIB interface messages can be further subdivided into:

- **Universal commands:** act on all instruments connected to the GPIB bus without previous addressing
- **Addressed commands:** only act on instruments previously addressed as listeners

Universal Commands

Universal commands are encoded in the range 10 through 1F hex. They affect all instruments connected to the bus and do not require addressing.

Command	Effect on the instrument
DCL (Device Clear)	Aborts the processing of the commands just received and sets the command processing software to a defined initial state. Does not change the instrument settings.
IFC (Interface Clear) *)	Resets the interfaces to the default setting.
LLO (Local Lockout)	The LOC/IEC ADDR key is disabled.
SPE (Serial Poll Enable)	Ready for serial poll.
SPD (Serial Poll Disable)	End of serial poll.
PPU (Parallel Poll Unconfigure)	End of the parallel-poll state.
*) IFC is not a real universal command, it is sent via a separate line; however, it also affects all instruments connected to the bus and does not require addressing	

Addressed Commands

Addressed commands are encoded in the range 00 through 0F hex. They only affect instruments addressed as listeners.

Command	Effect on the instrument
GET (Group Execute Trigger)	Triggers a previously active instrument function (e.g. a sweep). The effect of the command is the same as with that of a pulse at the external trigger signal input.
GTL (Go to Local)	Transition to the "local" state (manual control).
GTR (Go to Remote)	Transition to the "remote" state (remote control).
PPC (Parallel Poll Configure)	Configures the instrument for parallel poll.
SDC (Selected Device Clear)	Aborts the processing of the commands just received and sets the command processing software to a defined initial state. Does not change the instrument setting.

6.1.6.2 GPIB Instrument Address

In order to operate the instrument via remote control, it must be addressed using the GPIB address. The remote control address is factory preset, but it can be changed if it does not fit in the network environment. For remote control, addresses 0 through 30 are allowed. The GPIB address is maintained after a reset of the instrument settings.

Changing the GPIB address of the instrument

The GPIB address can be changed manually or using a remote control command.

1. Manually: press the SETUP key and select "Remote > GPIB".

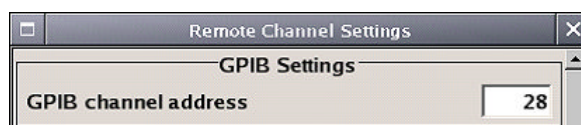

Select parameter "GPIB channel address" and set the GPIB address.

- Using remote control command:

```
SYST:COMM:GPIB:ADDR 18
```

6.2 Starting a Remote Control Session

The instrument and the controller have to be connected with the suitable cable and switched on.

A remote control program must open a connection to the instrument (using VISA functionality), before it can send commands to and receive device responses from the instrument.



Instrument Address

In order to operate the instrument via remote control it must be addressed using the defined interface address. See [chapter 6.1.3, "LAN Interface"](#), on page 316, [chapter 6.1.4, "USB Interface"](#), on page 319, [chapter 6.1.5, "Serial Interface"](#), on page 319 or [chapter 6.1.6, "GPIB Interface \(IEC/IEEE Bus Interface\)"](#), on page 320 for details.



The VISA resource strings are indicated in the "Setup > Remote Channel Settings" menu.

Refer to [chapter 6.2.3, "Examples"](#), on page 323 for practical examples on setting up of a remote control link and starting of a remote control session.

6.2.1 Switching to Remote Control

When it is switched on, the instrument is always in the manual operating state and can be operated via the front panel controls (for instruments equipped with a display) or via mouse and external keyboard.

Starting remote control

- Send a command from a controller to the instrument.

The instrument is switched to remote control as soon as it receives a command from the controller.

While remote control is active, operation via the front panel or via mouse and keyboard is disabled and "REMOTE" is displayed in the status line.

The instrument remains in the remote state until it is reset to the manual state via the instrument or via the remote control interface (see [chapter 6.2.2, "Returning to Manual Operation"](#), on page 323).

Tip: Switching from manual operation to remote control and vice versa does not affect the other instrument settings.

2. Although operation via front panel, mouse and keyboard is disabled, the dialog boxes can still be opened, e.g. to verify settings, but buttons and setting fields are displayed in gray and cannot be activated.
Use the command `SYST:KLOC ON` to disable the access to the dialogs.
3. To prevent unintentional return to manual operation, disable the LOCAL key of the instrument using the `&LLO` command (see [chapter 6.1.3.4, "LAN Interface Messages"](#), on page 318).
The instrument switches to "REM-LLO" state and transition to manual mode is not anymore possible via the remote control command `*GTL`.
Switching to manual mode is only possible via remote control then.
4. Enable the LOCAL key with the interface message `&NREN`.

6.2.2 Returning to Manual Operation



Before returning to manual control, command processing must be completed. Otherwise, the instrument switches back to remote control immediately.

- ▶ To return to manual operation, use one of the following ways:
 - a) Press the LOCAL key on the front panel.
 - b) Select "Setup > Remote Control Channels" and press "Local".
 - c) While using the socket communication, terminate the remote control session.
 - d) Send the interface command `>L` via the remote control interface.

Tip: Use the `&NREN` to enable the LOCAL key if the key is disabled.

6.2.3 Examples

This sections provides examples for setting up of remote control connection and starting a remote control session over LAN and GPIB interfaces.

This section assumes basic knowledge of programming and operation of the controller. A description of the interface commands can be obtained from the relevant manuals.

6.2.3.1 Remote Control over GPIB

The program example in this section is written in VISUAL BASIC. A condition for programming in VISUAL BASIC is that the modules NIGLOBAL (`Niglobal.bas`) and VBIB32 (`Vbib_32.bas`) are added to the projects.



Drivers for instrument, e.g. IVI-COM and LabVIEW drivers, are available in the download area of the product website (http://www2.rohde-schwarz.com/en/products/test_and_measurement/product_categories/signal_generation/).

Starting a remote control session over GPIB

As a prerequisite, the GPIB address of the instrument, which is factory-set to 28, must not have been changed.

1. Connect instrument and controller using GPIB cable and switch them on.
2. Execute following commands on the controller:
 - a) Open port to the instrument
`CALL IBFIND("DEV1", generator%)`
 - b) Inform controller about instrument address
`CALL IBPAD(generator%, 28)`
 - c) Reset instrument
`CALL IBWRT(generator%, "*RST;*CLS")`
 - d) Set instrument to new address
`CALL IBWRT(generator%, "SYST:COMM:GPIB:ADDR 18")`
 - e) Inform controller about new address
`CALL IBPAD(generator%, 18)`

The GPIB address of the instrument is changed.

3. To return to manual operation, press the LOCAL key at the front panel.

6.2.3.2 Remote Control over LAN using VXI-11 Protocol

Through the examples in this section, the program 'Measurement & Automation Explorer' from National Instruments under Windows operating system is used for setting up a LAN remote control link and starting a remote control session.

Configuring the controller



The instrument is preconfigured for networks using DHCP (dynamic host configuration protocol). If this configuration is used, enter the computer name in the position of the IP address.

To enable the external controller to communicate with the software via TCP/IP protocol, set up a remote control link as follow:

1. Connect the controller and the instrument to the network (network cable) and switch them on.
2. Start the 'Measurement & Automation Control' program on the controller.
3. Select "Devices and Interfaces > Create New".



4. Select "VISA TCP/IP Resource" and confirm with "Next".

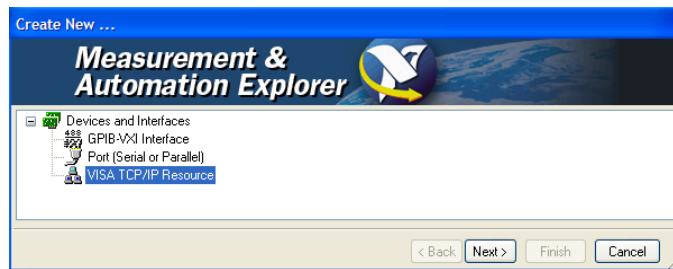

5. Choose the type of TCP/IP resource you wish to add and select Next.

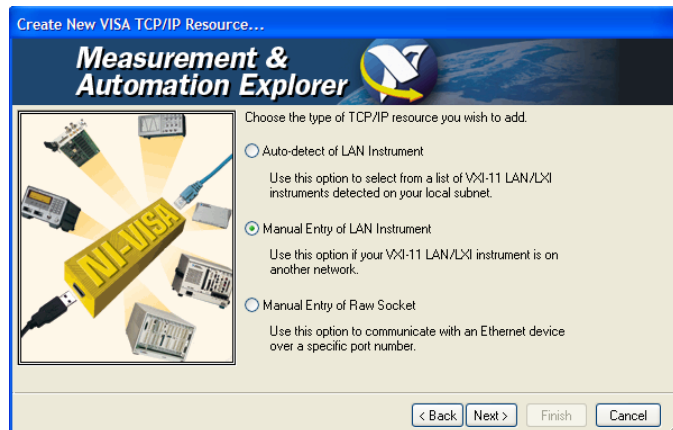

6. Enter the IP address or the host name of the R&S SMA and select "Next".

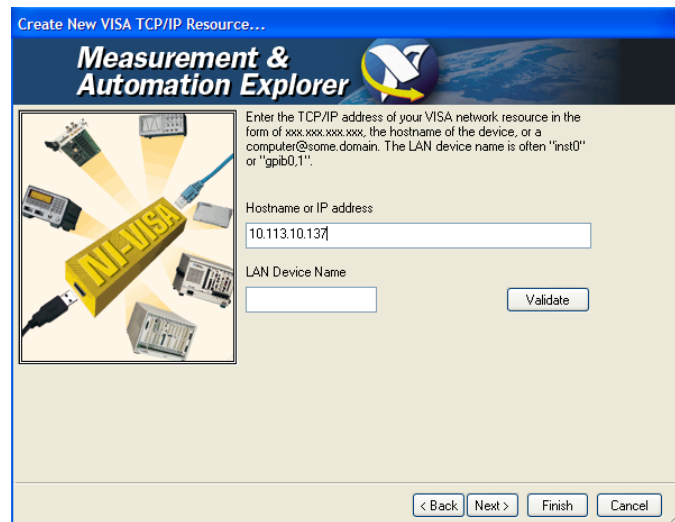

7. Enter the alias name if required.
The alias name must not be mistaken for the computer name. It is only used for instrument identification within the program and displayed in the menu as an option in case of an Ethernet link.
8. Confirm the settings with "Finish".
The instrument is configured and the settings are displayed in the "TCP/IP Settings" tab.

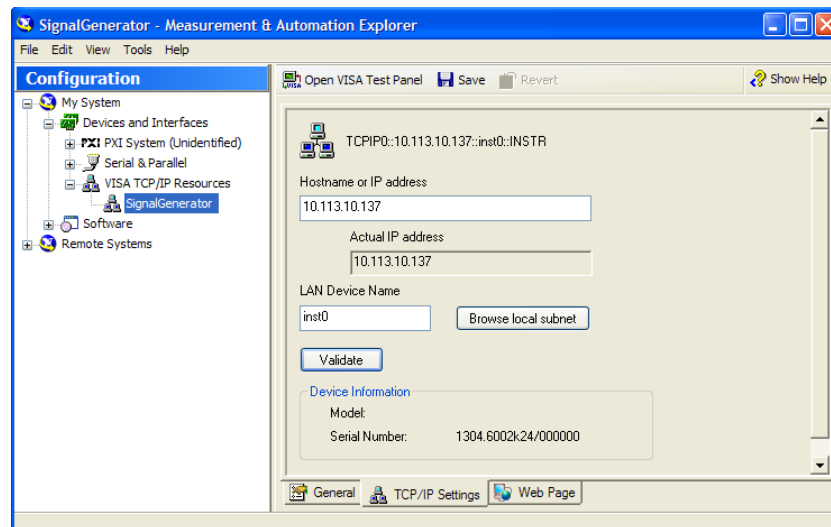

9. To test the connection, select "Validate".
A message indicates whether the link to the instrument can be set up or not.

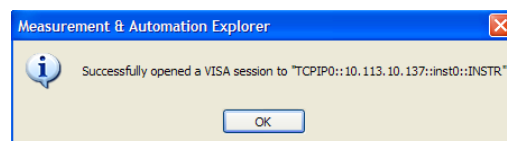

If a connection cannot be set up, check whether the controller and the instrument are connected to the network (network cable) and switched on. Correct spelling of the IP address or the computer name can also be checked. For further error location, inform the network administrator. In large networks, specification of additional addresses may be required for link setup, e.g. gateway and subnet mask, which are known to the network administrator.

The instrument is now registered in the program and can be addressed via the resource string or alias name.

Starting a remote control over LAN (using VXI-11)

1. Start the 'Measurement & Automation Explorer' on the controller.
2. In the "Configuration" window, select "Device and Interfaces > VISA TCP/IP Resources", select the required instrument and select "Open VISA Test Panel".

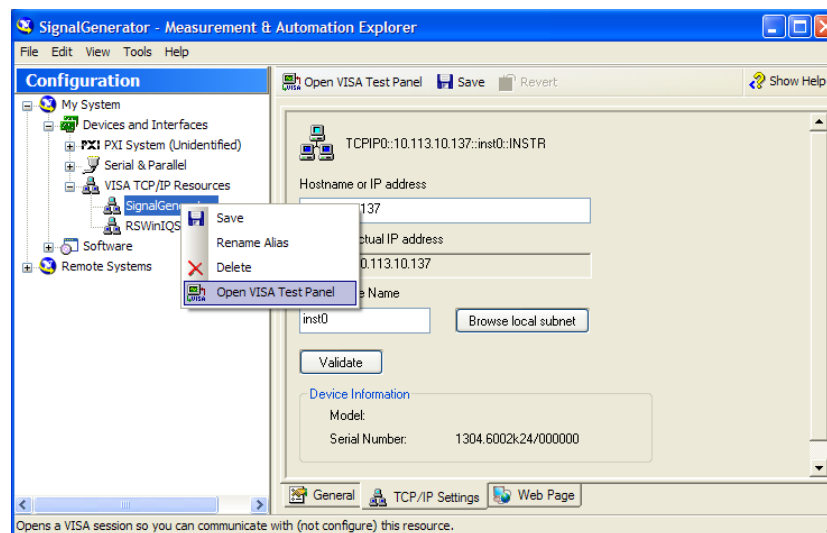

3. In the "viWrite" tab, write the command to be send to the instrument and select "Execute".

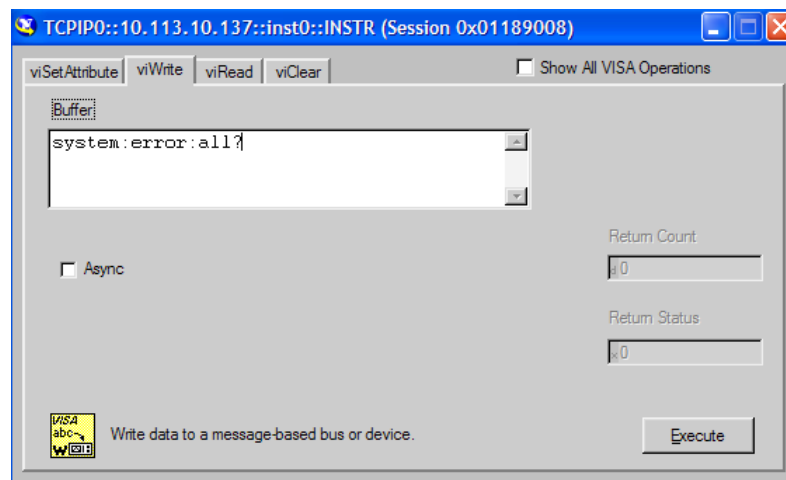

Instrument responses are displayed on the "viRead" tab.

Tip: For further program operation refer to the online help of the program.

6.2.3.3 Remote Control over LAN using Socket Communication

This chapter provides an example on how to establish a remote control connection over telnet protocol and a simple sockets-based program example that can be further developed.

Setting up a Telnet Connection

To control the software, only a telnet program is required. The telnet program is part of every operating system.

1. To establish a Telnet connection with the R&S SMA, start the telnet program and enter the socket address.

The socket address is a combination of the IP address or the host name of the R&S SMA and the number of the port configured for remote-control via telnet.

Tip: The R&S SMA uses the port number 5025 for remote connection via Telnet.

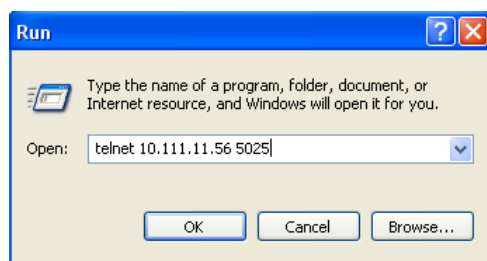

The connection to the instrument is set up and remote-control commands can be sent.

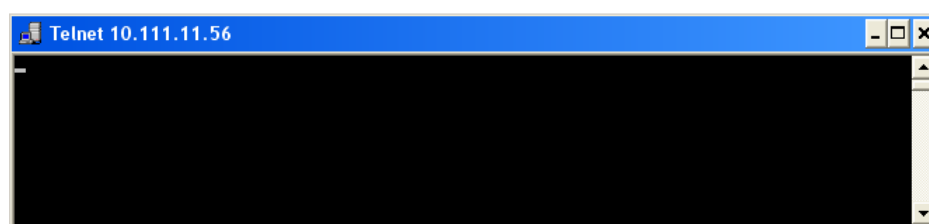

2. Even if the cursor is not visible on the screen, enter blind a remote-control command and confirm with Enter.

```

Telnet 10.111.11.56
Freq?
1500000000
freq 1.5 GHZ
Freq?
1500000000
pow?
0
pow -30
pow?
-30
-

```

After the first remote-control command had been send, the instrument is in the "REMOTE" state, i.e. instrument control from the front panel or via mouse and keyboard is disabled and "REMOTE" is displayed in the status line.

Telnet program examples

The following program example shows a simple TcpClient class that is intended to explain on how to get started with programming of sockets.

The example sets up a socket communication to R&S SMA and opens a simple user interface, very similar to the telnet, which allows input of commands. To enable real automation, further development of the program is required.

TcpClient.h

```

#include <string>
//defines structs for socket handling
#include <netinet/in.h>
using namespace std;
typedef struct sockaddr_in SockAddrStruct;
typedef struct hostent      HostInfoStruct;
class TcpClient
{
public:
    TcpClient();
    ~TcpClient();
    void connectToServer( string &hostname, int port );
    void disconnect( );
    void transmit( string &txString );
    void receive( string &rxString );
    string getCurrentHostName( ) const;
    int    getCurrentPort( ) const;
private:
    string      currentHostName;
    int         currentPort;
    int         currentSocketDescr;
    SockAddrStruct  serverAddress;
    HostInfoStruct * currentHostInfo;
    bool        clientIsConnected;

```

```

        int                receiveBufferSize;
};

```

TcpClient.cpp

```

#include <string>
//defines structs for socket handling
#include <netinet/in.h>
using namespace std;
typedef struct sockaddr_in SockAddrStruct;
typedef struct hostent     HostInfoStruct;
class TcpClient
{
public:
    TcpClient();
    ~TcpClient();
    void connectToServer( string &hostname, int port );
    void disconnect( );
    void transmit( string &txString );
    void receive( string &rxString );
    string getCurrentHostName( ) const;
    int    getCurrentPort( ) const;
private:
    string        currentHostName;
    int           currentPort;
    int           currentSocketDescr;
    SockAddrStruct serverAddress;
    HostInfoStruct * currentHostInfo;
    bool          clientIsConnected;
    int           receiveBufferSize;
};

#include <netdb.h>
#include <netinet/in.h>
#include <unistd.h>
#include "TcpClient.h"
TcpClient::TcpClient()
: currentHostName( "" )
, currentPort( 0 )
, currentSocketDescr( 0 )
, serverAddress ( )
, currentHostInfo( NULL )
, clientIsConnected( false )
, receiveBufferSize( 1024 )
{
}
TcpClient::~TcpClient()
{
    currentHostInfo = NULL;
}

```

```

void TcpClient::connectToServer( string &hostname, int port )
{
    currentHostInfo = gethostbyname( hostname.c_str( ) );
    if( currentHostInfo == NULL )
    {
        currentHostName = "";
        currentPort = 0;
        currentHostInfo = NULL;
        clientIsConnected = false;
        printf("error connecting host\n" );
    }
    currentHostName = hostname;
    currentPort = port;
    currentSocketDescr = socket(AF_INET, SOCK_STREAM, 0);
    if( currentSocketDescr == 0 )
    {
        currentHostName = "";
        currentPort = 0;
        currentHostInfo = NULL;
        clientIsConnected = false;
        printf("can't create socket\n" );
    }
    serverAddress.sin_family = currentHostInfo->h_addrtype;
    serverAddress.sin_port = htons( currentPort );
    memcpy( (char *) &serverAddress.sin_addr.s_addr,
        currentHostInfo->h_addr_list[0], currentHostInfo->h_length );
    if( connect( currentSocketDescr, ( struct sockaddr *) &serverAddress,
        sizeof( serverAddress ) ) < 0 )
    {
        throw string("can't connect server\n" );
    }
    clientIsConnected = true;
}
void TcpClient::disconnect( )
{
    if( clientIsConnected )
    {
        close( currentSocketDescr );
    }
    currentSocketDescr = 0;
    currentHostName = "";
    currentPort = 0;
    currentHostInfo = NULL;
    clientIsConnected = false;
}
void TcpClient::transmit( string &txString )
{
    if( !clientIsConnected )
    {

```



```

    throw string("connection must be established before any data can be sent\n");
}
char * transmitBuffer = new char[txString.length() + 1];
memcpy( transmitBuffer, txString.c_str(), txString.length() );
transmitBuffer[txString.length()] = '\n'; //newline is needed!
if( send( currentSocketDescr, transmitBuffer, txString.length() + 1, 0 ) < 0 )
{
    throw string("can't transmit data\n");
}
delete [] transmitBuffer;
}
void TcpClient::receive( string &rxString )
{
    if( !clientIsConnected )
    {
        throw string("connection must be established before any data can be received\n");
    }
    char * receiveBuffer = new char[receiveBufferSize];
    memset( receiveBuffer, 0, receiveBufferSize );
    bool receiving = true;
    while( receiving )
    {
        int receivedByteCount = recv( currentSocketDescr,
            receiveBuffer, receiveBufferSize, 0 );
        if( receivedByteCount < 0 )
        {
            throw string("error while receiving data\n");
        }
        rxString += string( receiveBuffer );
        receiving = ( receivedByteCount == receiveBufferSize );
    }
    delete [] receiveBuffer;
}
string TcpClient::getCurrentHostName( ) const
{
    return currentHostName;
}
int TcpClient::getCurrentPort( ) const
{
    return currentPort;
}

```

TelnetClient.cpp

```

#include <iostream>
#include "TcpClient.h"
void printUsage()
{
    cout<<"usage: EthernetRawCommand <server-ip> [scpi-command]"<<endl;
}

```

```

int main( int argc, char *argv[] )
{
    int errorCode          = 0; //no error
    bool useSingleCommand = false;
    string singleCommand  = "";
    string hostname       = "";
    int    port           = 5025;
    string input          = "";
    TcpClient client;
    switch( argc )
    {
        case 3:
            useSingleCommand = true;
            singleCommand    = argv[2];
        case 2:
            hostname         = argv[1];
            break;
        default:
            printUsage();
            return(-1);
    }
    try
    {
        client.connectToServer( hostname, port );
        bool terminate = false;
        while( !terminate )
        {
            char buffer[1024];
            if( useSingleCommand )
            {
                input = singleCommand; //send string
            }
            else
            {
                cin.getline( buffer, 1024 );
                input = buffer;
                if( input == "end" )
                {
                    terminate = true;
                }
            }
            if( !terminate)
            {
                client.transmit( input ); //send string
                int qPos = input.find( "?", 0 );
                //receive string only when needed
                if( qPos > 0 )
                {
                    string rcStr = "";
                    client.receive( rcStr );
                }
            }
        }
    }
}

```

```

        cout << rcStr << endl;
    }
}
if( useSingleCommand )
{
    terminate = true;
}
}
}catch( const string errorString )
{
    cout<<errorString<<endl;
}
client.disconnect( );
return errorCode;
}

```

6.3 SCPI Command Structure

SCPI commands consist of a so-called header and, in most cases, one or more parameters. The header and the parameters are separated by a "white space" (ASCII code 0 to 9, 11 to 32 decimal, e.g. blank). The headers may consist of several mnemonics (keywords). Queries are formed by appending a question mark directly to the header.

The commands can be either device-specific or device-independent (common commands). Common and device-specific commands differ in their syntax.

6.3.1 Syntax for Common Commands

Common (=device-independent) commands consist of a header preceded by an asterisk (*) and possibly one or more parameters.

Examples:

*RST	RESET	Resets the instrument.
*ESE	EVENT STATUS ENABLE	Sets the bits of the event status enable registers.
*ESR?	EVENT STATUS QUERY	Queries the contents of the event status register.
*IDN?	IDENTIFICATION QUERY	Queries the instrument identification string.

6.3.2 Syntax for Device-Specific Commands



Not all commands used in the following examples are necessarily implemented in the instrument.

For demonstration purposes only, assume the existence of the following commands for this section:

- DISPLAY[:WINDow<1...4>]:MAXimize <Boolean>
- FORMat:READings:DATA <type>[,<length>]
- HCOpy:DEvice:COLor <Boolean>
- HCOpy:DEvice:CMAP:COLor:RGB <red>,<green>,<blue>
- HCOpy[:IMMediate]
- HCOpy:ITEM:ALL
- HCOpy:ITEM:LABel <string>
- HCOpy:PAGE:DIMensions:QUADrant [<N>]
- HCOpy:PAGE:ORientation LANDscape | PORTrait
- HCOpy:PAGE:SCALE <numeric value>
- MMEMory:COpy <file_source>,<file_destination>
- SENSE:BANDwidth|BWIDth[:RESolution] <numeric_value>
- SENSE:FREQuency:STOP <numeric value>
- SENSE:LIST:FREQuency <numeric_value>{,<numeric_value>}

Long and short form

The mnemonics feature a long form and a short form. The short form is marked by upper case letters, the long form corresponds to the complete word. Either the short form or the long form can be entered; other abbreviations are not permitted.

Example:

HCOpy:DEvice:COLor ON is equivalent to HCOP:DEV:COL ON.



Case-insensitivity

Upper case and lower case notation only serves to distinguish the two forms in the manual, the instrument itself is case-insensitive.

Numeric suffixes

If a command can be applied to multiple instances of an object, e.g. specific channels or sources, the required instances can be specified by a suffix added to the command. Numeric suffixes are indicated by angular brackets (<1...4>, <n>, <i>) and are replaced by a single value in the command. Entries without a suffix are interpreted as having the suffix 1.

Example:

Definition: `HCOPY:PAGE:DIMensions:QUADrant [<N>]`

Command: `HCOP:PAGE:DIM:QUAD2`

This command refers to the quadrant 2.

**Different numbering in remote control**

For remote control, the suffix may differ from the number of the corresponding selection used in manual operation. SCPI prescribes that suffix counting starts with 1. Suffix 1 is the default state and used when no specific suffix is specified.

Some standards define a fixed numbering, starting with 0. If the numbering differs in manual operation and remote control, it is indicated for the corresponding command.

Optional mnemonics

Some command systems permit certain mnemonics to be inserted into the header or omitted. These mnemonics are marked by square brackets in the description. The instrument must recognize the long command to comply with the SCPI standard. Some commands are considerably shortened by these optional mnemonics.

Example:

Definition: `HCOPY[:IMMEDIATE]`

Command: `HCOP:IMM` is equivalent to `HCOP`

**Optional mnemonics with numeric suffixes**

Do not omit an optional mnemonic if it includes a numeric suffix that is relevant for the effect of the command.

Example:

Definition: `DISPlay[:WINDow<1...4>]:MAXimize <Boolean>`

Command: `DISP:MAX ON` refers to window 1.

In order to refer to a window other than 1, you must include the optional `WINDow` parameter with the suffix for the required window.

`DISP:WIND2:MAX ON` refers to window 2.

Parameters

Parameters must be separated from the header by a "white space". If several parameters are specified in a command, they are separated by a comma (,). For a description of the parameter types, refer to [chapter 6.3.3, "SCPI Parameters"](#), on page 337.

Example:

Definition: `HCOPY:DEvice:CMAP:COLor:RGB <red>,<green>,<blue>`

Command: `HCOP:DEV:CMAP:COL:RGB 3,32,44`

Special characters

	<p>Parameters</p> <p>A vertical stroke in parameter definitions indicates alternative possibilities in the sense of "or". The effect of the command differs, depending on which parameter is used.</p> <p>Example:</p> <p>Definition: <code>HCOPY:PAGE:ORIENTATION LANDscape PORTRait</code></p> <p>Command <code>HCOP:PAGE:ORI LAND</code> specifies landscape orientation</p> <p>Command <code>HCOP:PAGE:ORI PORT</code> specifies portrait orientation</p> <p>Mnemonics</p> <p>A selection of mnemonics with an identical effect exists for several commands. These mnemonics are indicated in the same line; they are separated by a vertical stroke. Only one of these mnemonics needs to be included in the header of the command. The effect of the command is independent of which of the mnemonics is used.</p> <p>Example:</p> <p>Definition: <code>SENSE:BANDwidth BWIDTH[:RESolution] <numeric_value></code></p> <p>The two following commands with identical meaning can be created:</p> <p><code>SENS:BAND:RES 1</code></p> <p><code>SENS:BWID:RES 1</code></p>
[]	<p>Mnemonics in square brackets are optional and may be inserted into the header or omitted.</p> <p>Example: <code>HCOPY[:IMMEDIATE]</code></p> <p><code>HCOP:IMM</code> is equivalent to <code>HCOP</code></p>
{ }	<p>Parameters in curly brackets are optional and can be inserted once or several times, or omitted.</p> <p>Example: <code>SENSE:LIST:FREQUENCY <numeric_value>{,<numeric_value>}</code></p> <p>The following are valid commands:</p> <p><code>SENS:LIST:FREQ 10</code></p> <p><code>SENS:LIST:FREQ 10,20</code></p> <p><code>SENS:LIST:FREQ 10,20,30,40</code></p>

6.3.3 SCPI Parameters

Many commands are supplemented by a parameter or a list of parameters. The parameters must be separated from the header by a "white space" (ASCII code 0 to 9, 11 to 32 decimal, e.g. blank). Allowed parameters are:

- Numeric values
- Special numeric values
- Boolean parameters
- Text
- Character strings
- Block data

The parameters required for each command and the allowed range of values are specified in the command description.

Numeric values

Numeric values can be entered in any form, i.e. with sign, decimal point and exponent. Values exceeding the resolution of the instrument are rounded up or down. The mantissa may comprise up to 255 characters, the exponent must lie inside the value range -32000 to 32000. The exponent is introduced by an "E" or "e". Entry of the exponent alone is not allowed. In the case of physical quantities, the unit can be entered. Allowed unit prefixes are G (giga), MA (mega), MOHM and MHZ (are also allowed), K (kilo), M (milli), U (micro) and N (nano). If the unit is missing, the basic unit is used.

Example: `SENS:FREQ:STOP 1.5GHz = SENS:FREQ:STOP 1.5E9`

Units

For physical quantities, the unit can be entered. Allowed unit prefixes are:

- G (giga)
- MA (mega), MOHM, MHZ
- K (kilo)
- M (milli)
- U (micro)
- N (nano)

If the unit is missing, the basic unit is used.

Example:

`SENSe:FREQ:STOP 1.5GHz = SENSe:FREQ:STOP 1.5E9`

Some settings allow relative values to be stated in percent. According to SCPI, this unit is represented by the `PCT` string.

Example:

`HCOP:PAGE:SCAL 90PCT`

Special numeric values

The texts listed below are interpreted as special numeric values. In the case of a query, the numeric value is provided.

- **MIN/MAX**
MINimum and MAXimum denote the minimum and maximum value.
- **DEF**
DEFault denotes a preset value which has been stored in the EPROM. This value conforms to the default setting, as it is called by the `*RST` command.
- **UP/DOWN**
UP, DOWN increases or reduces the numeric value by one step. The step width can be specified via an allocated step command for each parameter which can be set via UP, DOWN.
- **INF/NINF**

INFinity, Negative INFinity (NINF) represent the numeric values 9.9E37 or -9.9E37, respectively. INF and NINF are only sent as instrument responses.

- **NAN**

Not A Number (NAN) represents the value 9.91E37. NAN is only sent as a instrument response. This value is not defined. Possible causes are the division of zero by zero, the subtraction of infinite from infinite and the representation of missing values.

Example:

Setting command: `SENSe:LIST:FREQ MAXimum`

Query: `SENS:LIST:FREQ?`, Response: `3.5E9`



Queries for special numeric values

The numeric values associated to `MAXimum`/`MINimum`/`DEFault` can be queried by adding the corresponding mnemonics to the command. They must be entered following the quotation mark.

Example: `SENSe:LIST:FREQ? MAXimum`

Returns the maximum numeric value as a result.

Boolean Parameters

Boolean parameters represent two states. The "ON" state (logically true) is represented by "ON" or a numeric value 1. The "OFF" state (logically untrue) is represented by "OFF" or the numeric value 0. The numeric values are provided as the response for a query.

Example:

Setting command: `HCOPY:DEV:COL ON`

Query: `HCOPY:DEV:COL?`

Response: `1`

Text parameters

Text parameters observe the syntactic rules for mnemonics, i.e. they can be entered using a short or long form. Like any parameter, they have to be separated from the header by a white space. In the case of a query, the short form of the text is provided.

Example:

Setting command: `HCOPY:PAGE:ORIENTATION LANDscape`

Query: `HCOP:PAGE:ORI?`

Response: `LAND`

Character strings

Strings must always be entered in quotation marks (' or ").

Example:

```
HCOP:ITEM:LABel "Test1" or HCOP:ITEM:LABel 'Test1'
```

Block data

Block data is a format which is suitable for the transmission of large amounts of data. A command using a block data parameter has the following structure:

Example:

```
FORMat:READings:DATA #45168xxxxxxxx
```

The ASCII character # introduces the data block. The next number indicates how many of the following digits describe the length of the data block. In the example the 4 following digits indicate the length to be 5168 bytes. The data bytes follow. During the transmission of these data bytes all end or other control signs are ignored until all bytes are transmitted.

#0 specifies a data block of indefinite length. The use of the indefinite format requires a `NL^END` message to terminate the data block. This format is useful when the length of the transmission is not known or if speed or other considerations prevent segmentation of the data into blocks of definite length.

6.3.4 Overview of Syntax Elements

The following table provides an overview of the syntax elements:

:	The colon separates the mnemonics of a command. In a command line the separating semicolon marks the uppermost command level.
;	The semicolon separates two commands of a command line. It does not alter the path.
,	The comma separates several parameters of a command.
?	The question mark forms a query.
*	The asterisk marks a common command.
'' ..	Quotation marks introduce a string and terminate it (both single and double quotation marks are possible).
#	The hash symbol introduces binary, octal, hexadecimal and block data. <ul style="list-style-type: none"> • Binary: #B10110 • Octal: #O7612 • Hexa: #HF3A7 • Block: #21312
	A "white space" (ASCII-Code 0 to 9, 11 to 32 decimal, e.g. blank) separates the header from the parameters.

6.3.5 Structure of a command line

A command line may consist of one or several commands. It is terminated by one of the following:

- a <New Line>
- a <New Line> with EOI
- an EOI together with the last data byte

Several commands in a command line must be separated by a semicolon ";". If the next command belongs to a different command system, the semicolon is followed by a colon.

Example:

```
MMEM:COPY "Test1", "MeasurementXY";:HCOP:ITEM ALL
```

This command line contains two commands. The first command belongs to the MMEM system, the second command belongs to the HCOP system.

If the successive commands belong to the same system, having one or several levels in common, the command line can be abbreviated. To this end, the second command after the semicolon starts with the level that lies below the common levels. The colon following the semicolon must be omitted in this case.

Example:

```
HCOP:ITEM ALL;:HCOP:IMM
```

This command line contains two commands. Both commands are part of the HCOP command system, i.e. they have one level in common.

When abbreviating the command line, the second command begins with the level below HCOP. The colon after the semicolon is omitted. The abbreviated form of the command line reads as follows:

```
HCOP:ITEM ALL;IMM
```

A new command line always begins with the complete path.

Example:

```
HCOP:ITEM ALL
```

```
HCOP:IMM
```

6.3.6 Responses to Queries

A query is defined for each setting command unless explicitly specified otherwise. It is formed by adding a question mark to the associated setting command. According to SCPI, the responses to queries are partly subject to stricter rules than in standard IEEE 488.2.

- The requested parameter is transmitted without a header.
Example: HCOP:PAGE:ORI?, Response: LAND
- Maximum values, minimum values and all other quantities that are requested via a special text parameter are returned as numeric values.
Example: SENSE:FREQUENCY:STOP? MAX, Response: 3.5E9
- Numeric values are output without a unit. Physical quantities are referred to the basic units or to the units set using the Unit command. The response 3.5E9 in the previous example stands for 3.5 GHz.

- Truth values (Boolean values) are returned as 0 (for OFF) and 1 (for ON).

Example:

Setting command: `HCOpy:DEV:COL ON`

Query: `HCOpy:DEV:COL?`

Response: 1

- Text (character data) is returned in a short form.

Example:

Setting command: `HCOpy:PAGE:ORIENTATION LANDscape`

Query: `HCOp:PAGE:ORI?`

Response: LAND

6.4 Command Sequence and Synchronization

IEEE 488.2 defines a distinction between overlapped and sequential commands:

- A sequential command is one which finishes executing before the next command starts executing. Commands that are processed quickly are usually implemented as sequential commands. Sequential commands are not implemented in the instrument, however the execution time of most commands is so short that they act as sequential commands when sent in different command lines.
- An overlapping command is one which does not automatically finish executing before the next command starts executing. Usually, overlapping commands take longer to process and allow the program to do other tasks while being executed. If overlapping commands do have to be executed in a defined order, e.g. in order to avoid wrong measurement results, they must be serviced sequentially. This is called synchronization between the controller and the instrument.

Setting commands within one command line, even though they may be implemented as sequential commands, are not necessarily serviced in the order in which they have been received. In order to make sure that commands are actually carried out in a certain order, each command must be sent in a separate command line.

Example: Commands and queries in one message

The response to a query combined in a program message with commands that affect the queried value is not predictable.

The following commands always return the specified result:

```
:FREQ:STAR 1GHZ;SPAN 100 :FREQ:STAR?
```

Result:

```
1000000000 (1 GHz)
```

Whereas the result for the following commands is not specified by SCPI:

```
:FREQ:STAR 1GHz;STAR?;SPAN 1000000
```

The result could be the value of `START` before the command was sent since the instrument might defer executing the individual commands until a program message terminator is received. The result could also be 1 GHz if the instrument executes commands as they are received.



As a general rule, send commands and queries in different program messages.

Example: Overlapping command with *OPC

The instrument implements `INITiate[:IMMEDIATE]` as an overlapped command. Assuming that `INITiate[:IMMEDIATE]` takes longer to execute than `*OPC`, sending the following command sequence results in initiating a sweep and, after some time, setting the `OPC` bit in the `ESR`:

```
INIT; *OPC.
```

Sending the following commands still initiates a sweep:

```
INIT; *OPC; *CLS
```

However, since the operation is still pending when the instrument executes `*CLS`, forcing it into the "Operation Complete Command Idle" State (OCIS), `*OPC` is effectively skipped. The `OPC` bit is not set until the instrument executes another `*OPC` command.

6.4.1 Preventing Overlapping Execution

To prevent an overlapping execution of commands, one of the commands `*OPC`, `*OPC?` or `*WAI` can be used. All three commands cause a certain action only to be carried out after the hardware has been set. By suitable programming, the controller can be forced to wait for the corresponding action to occur.

Table 6-2: Synchronization using *OPC, *OPC? and *WAI

Com-mand	Action	Programming the controller
*OPC	Sets the Operation Complete bit in the ESR after all previous commands have been executed.	<ul style="list-style-type: none"> Setting bit 0 in the ESE Setting bit 5 in the SRE Waiting for service request (SRQ)
*OPC?	Stops command processing until 1 is returned. This is only the case after the Operation Complete bit has been set in the ESR. This bit indicates that the previous setting has been completed.	Sending <code>*OPC?</code> directly after the command whose processing should be terminated before other commands can be executed.
*WAI	Stops further command processing until all commands sent before <code>*WAI</code> have been executed.	Sending <code>*WAI</code> directly after the command whose processing should be terminated before other commands are executed.

Command synchronization using `*WAI` or `*OPC?` appended to an overlapped command is a good choice if the overlapped command takes only little time to process. The two synchronization techniques simply block overlapped execution of the command.

For time consuming overlapped commands it is usually desirable to allow the controller or the instrument to do other useful work while waiting for command execution. Use one of the following methods:

*OPC with a service request

1. Set the `OPC` mask bit (bit no. 0) in the `ESE`: `*ESE 1`

2. Set bit no. 5 in the SRE: *SRE 32 to enable ESB service request.
3. Send the overlapped command with *OPC
4. Wait for a service request

The service request indicates that the overlapped command has finished.

***OPC? with a service request**

1. Set bit no. 4 in the SRE: *SRE 16 to enable MAV service request.
2. Send the overlapped command with *OPC?
3. Wait for a service request

The service request indicates that the overlapped command has finished.

Event Status Register (ESE)

1. Set the OPC mask bit (bit no. 0) in the ESE: *ESE 1
2. Send the overlapped command without *OPC, *OPC? or *WAI
3. Poll the operation complete state periodically (by means of a timer) using the sequence: *OPC; *ESR?

A return value (LSB) of 1 indicates that the overlapped command has finished.

***OPC? with short timeout**

1. Send the overlapped command without *OPC, *OPC? or *WAI
2. Poll the operation complete state periodically (by means of a timer) using the sequence: <short timeout>; *OPC?
3. A return value (LSB) of 1 indicates that the overlapped command has finished. In case of a timeout, the operation is ongoing.
4. Reset timeout to former value
5. Clear the error queue with `SYStem:ERRor?` to remove the "-410, Query interrupted" entries.

Using several threads in the controller application

As an alternative, provided the programming environment of the controller application supports threads, separate threads can be used for the application GUI and for controlling the instrument(s) via SCPI.

A thread waiting for a *OPC? thus will not block the GUI or the communication with other instruments.

6.5 Status Reporting System

The status reporting system stores all information on the current operating state of the instrument, and on errors which have occurred. This information is stored in the status registers and in the error queue. Both can be queried with the commands `STATUS...`

6.5.1 Hierarchy of status registers

As shown in the following figure, the status information is of hierarchical structure.

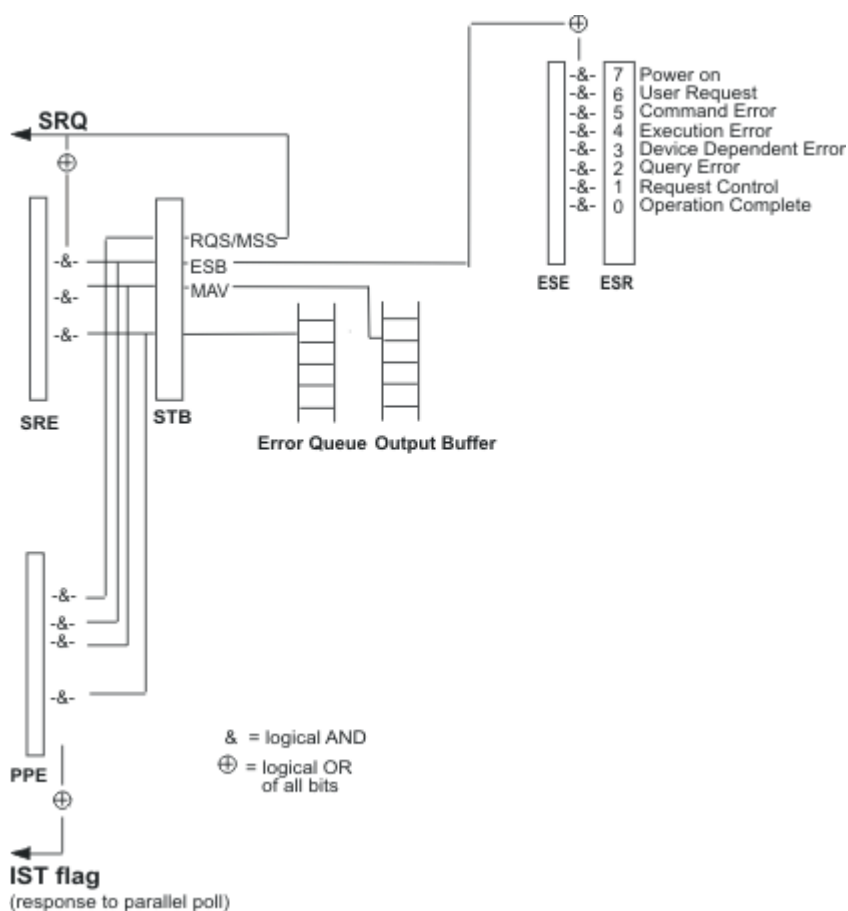

Fig. 6-1: Graphical overview of the status registers hierarchy

- STB, SRE**
 The S**T**atus **B**yte (*STB*) register and its associated mask register **S**ervice **R**quest **E**nable (*SRE*) form the highest level of the status reporting system. The *STB* provides a rough overview of the instrument status, collecting the information of the lower-level registers.
- ESR, SCPI registers**
 The *STB* receives its information from the following registers:
 - The **E**vent **S**tatus **R**egister (*ESR*) with the associated mask register **s**tandard **E**vent **S**tatus **E**nable (*ESE*).

- The `STATUS:OPERation` and `STATUS:QUEStionable` registers which are defined by SCPI and contain detailed information on the instrument.
- **IST, PPE**
The `IST` flag ("Individual S**T**atus"), like the `SRQ`, combines the entire instrument status in a single bit. The `PPE` fulfills the same function for the `IST` flag as the `SRE` for the service request.
- **Output buffer**
The output buffer contains the messages the instrument returns to the controller. It is not part of the status reporting system but determines the value of the `MAV` bit in the `STB` and thus is represented in the overview.

All status registers have the same internal structure.



SRE, ESE

The service request enable register `SRE` can be used as `ENABLE` part of the `STB` if the `STB` is structured according to SCPI. By analogy, the `ESE` can be used as the `ENABLE` part of the `ESR`.

6.5.2 Structure of a SCPI Status Register

Each standard SCPI register consists of 5 parts. Each part has a width of 16 bits and has different functions. The individual bits are independent of each other, i.e. each hardware status is assigned a bit number which is valid for all five parts. Bit 15 (the most significant bit) is set to zero for all parts. Thus the contents of the register parts can be processed by the controller as positive integers.

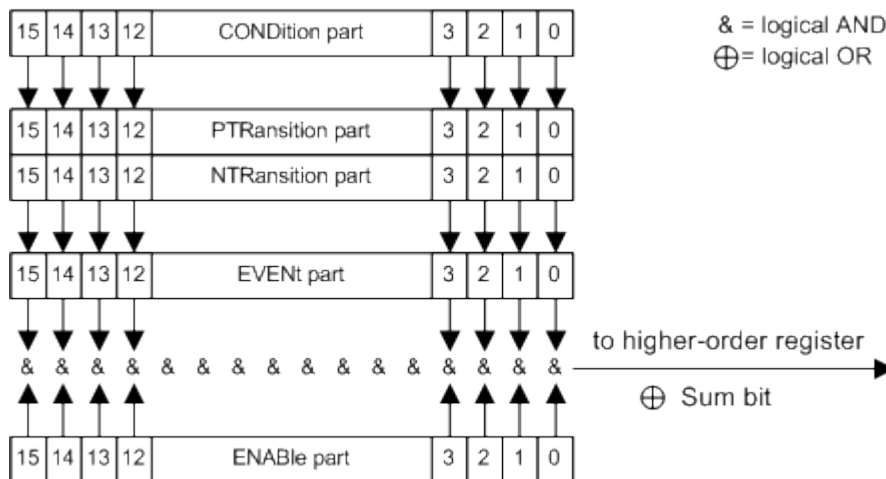

Fig. 6-2: The status-register model

Description of the five status register parts

The five parts of a SCPI register have different properties and functions:

- **CONDition**

The `CONDition` part is written into directly by the hardware or the sum bit of the next lower register. Its contents reflect the current instrument status. This register part can only be read, but not written into or cleared. Its contents are not affected by reading.

- **PTRansition**

The two transition register parts define which state transition of the `CONDition` part (none, 0 to 1, 1 to 0 or both) is stored in the `EVENT` part.

The `Positive-TRansition` part acts as a transition filter. When a bit of the `CONDition` part is changed from 0 to 1, the associated `PTR` bit decides whether the `EVENT` bit is set to 1.

- `PTR` bit =1: the `EVENT` bit is set.
- `PTR` bit =0: the `EVENT` bit is not set.

This part can be written into and read as required. Its contents are not affected by reading.

- **NTRansition**

The `Negative-TRansition` part also acts as a transition filter. When a bit of the `CONDition` part is changed from 1 to 0, the associated `NTR` bit decides whether the `EVENT` bit is set to 1.

- `NTR` bit =1: the `EVENT` bit is set.
- `NTR` bit =0: the `EVENT` bit is not set.

This part can be written into and read as required. Its contents are not affected by reading.

- **EVENT**

The `EVENT` part indicates whether an event has occurred since the last reading, it is the "memory" of the condition part. It only indicates events passed on by the transition filters. It is permanently updated by the instrument. This part can only be read by the user. Reading the register clears it. This part is often equated with the entire register.

- **ENABLE**

The `ENABLE` part determines whether the associated `EVENT` bit contributes to the sum bit (see below). Each bit of the `EVENT` part is "ANDed" with the associated `ENABLE` bit (symbol '&'). The results of all logical operations of this part are passed on to the sum bit via an "OR" function (symbol '+').

`ENABLE` bit = 0: the associated `EVENT` bit does not contribute to the sum bit

`ENABLE` bit = 1: if the associated `EVENT` bit is "1", the sum bit is set to "1" as well.

This part can be written into and read by the user as required. Its contents are not affected by reading.

Sum bit

The sum bit is obtained from the `EVENT` and `ENABLE` part for each register. The result is then entered into a bit of the `CONDition` part of the higher-order register.

The instrument automatically generates the sum bit for each register. Thus an event can lead to a service request throughout all levels of the hierarchy.

6.5.3 Contents of the Status Registers

In the following sections, the contents of the status registers are described in more detail.

6.5.3.1 Status Byte (STB) and Service Request Enable Register (SRE)

The `STatus Byte` (STB) is already defined in IEEE 488.2. It provides a rough overview of the instrument status by collecting the pieces of information of the lower registers. A special feature is that bit 6 acts as the sum bit of the remaining bits of the status byte.

The STB is read using the command `*STB?` or a serial poll.

The `STatus Byte` (STB) is linked to the `Service Request Enable` (SRE) register. Each bit of the STB is assigned a bit in the SRE. Bit 6 of the SRE is ignored. If a bit is set in the SRE and the associated bit in the STB changes from 0 to 1, a service request (SRQ) is generated. The SRE can be set using the command `*SRE` and read using the command `*SRE?`.

Table 6-3: Meaning of the bits used in the status byte

Bit No.	Meaning
0...1	Not used
2	Error Queue not empty The bit is set when an entry is made in the error queue. If this bit is enabled by the SRE, each entry of the error queue generates a service request. Thus an error can be recognized and specified in greater detail by polling the error queue. The poll provides an informative error message. This procedure is to be recommended since it considerably reduces the problems involved with remote control.
3	Not used.
4	MAV bit (message available) The bit is set if a message is available in the output buffer which can be read. This bit can be used to enable data to be automatically read from the instrument to the controller.
5	ESB bit Sum bit of the event status register. It is set if one of the bits in the event status register is set and enabled in the event status enable register. Setting of this bit indicates a serious error which can be specified in greater detail by polling the event status register.
6	MSS bit (master status summary bit) The bit is set if the instrument triggers a service request. This is the case if one of the other bits of this registers is set together with its mask bit in the service request enable register SRE.
7	Not used.

6.5.3.2 IST Flag and Parallel Poll Enable Register (PPE)

As with the SRQ, the IST flag combines the entire status information in a single bit. It can be read by means of a parallel poll (see [chapter 6.5.5.3, "Parallel Poll"](#), on page 350) or using the command `*IST?`.

The parallel poll enable register (PPE) determines which bits of the STB contribute to the IST flag. The bits of the STB are "ANDed" with the corresponding bits of the PPE, with

bit 6 being used as well in contrast to the SRE. The IST flag results from the "ORing" of all results. The PPE can be set using commands *PRE and read using command *PRE?.

6.5.4 Event Status Register (ESR) and Event Status Enable Register (ESE)

The ESR is defined in IEEE 488.2. The event status register can be read out using command *ESR? on page 355. The ESE is the associated enable part. It can be set using the command *ESE on page 355 and read using the command *ESE?.

Table 6-4: Meaning of the bits used in the event status register

Bit No.	Meaning
0	Operation Complete This bit is set on receipt of the command *OPC exactly when all previous commands have been executed.
1	not used
2	Query Error This bit is set if either the controller wants to read data from the instrument without having sent a query, or if it does not fetch requested data and sends new instructions to the instrument instead. The cause is often a query which is faulty and hence cannot be executed.
3	Device-dependent Error This bit is set if a device dependent error occurs. An error message with a number between 300 and 399 or a positive error number, which denotes the error in greater detail, is entered into the error queue.
4	Execution Error This bit is set if a received command is syntactically correct but cannot be performed for other reasons. An error message with a number between 200 and 300, which denotes the error in greater detail, is entered into the error queue.
5	Command Error This bit is set if a command which is undefined or syntactically incorrect is received. An error message with a number between 100 and 200, which denotes the error in greater detail, is entered into the error queue.
6	User Request This bit is set on pressing the LOCAL key, i.e. when the instrument is switched over to manual operation.
7	Power On (supply voltage on) This bit is set on switching on the instrument.

6.5.5 Application of the Status Reporting System

The purpose of the status reporting system is to monitor the status of one or several devices in a measuring system. To do this and react appropriately, the controller must receive and evaluate the information of all devices. The following standard methods are used:

- **Service request** (SRQ) initiated by the instrument

- **Serial poll** of all devices in the bus system, initiated by the controller in order to find out who sent a SRQ and why
- **Parallel poll** of all devices
- Query of a **specific instrument status** by means of commands
- Query of the **error queue**

6.5.5.1 Service Request

Under certain circumstances, the instrument can send a service request (SRQ) to the controller. Usually this service request initiates an interrupt at the controller, to which the control program can react appropriately. An SRQ is always initiated if one or several of bits 2, 4 or 5 of the status byte are set and enabled in the SRE. Each of these bits combines the information of the error queue or the output buffer. In order to use the possibilities of the service request effectively, all bits should be set to "1" in the enable registers SRE and ESE.

Example:

Use command `*OPC` to generate an SRQ .

`*ESE 1` - set bit 0 of ESE (Operation Complete)

`*SRE 32` - set bit 5 of SRE (ESB).

After its settings have been completed, the instrument generates an SRQ.

The SRQ is the only possibility for the instrument to become active on its own. Each controller program should set the instrument such that a service request is initiated in the case of malfunction. The program should react appropriately to the service request.

6.5.5.2 Serial Poll

In a serial poll, just as with command `*STB`, the status byte of an instrument is queried. However, the query is realized via interface messages and is thus clearly faster.

The serial poll method is defined in IEEE 488.1 and used to be the only standard possibility for different instruments to poll the status byte. The method also works for instruments which do not adhere to SCPI or IEEE 488.2.

The serial poll is mainly used to obtain a fast overview of the state of several instruments connected to the controller.

6.5.5.3 Parallel Poll

In a parallel poll, up to eight instruments are simultaneously requested by the controller using a single command to transmit 1 bit of information each on the data lines, i.e., to set the data line allocated to each instrument to a logical "0" or "1".

In addition to the SRE register, which determines the conditions under which an SRQ is generated, there is a Parallel Poll Enable register (PPE) which is ANDed with the STB bit by bit, considering bit 6 as well. This register is ANDed with the STB bit by bit, considering bit 6 as well. The results are ORed, the result is possibly inverted and then sent

as a response to the parallel poll of the controller. The result can also be queried without parallel poll using the command `*IST?`.

The instrument first has to be set for the parallel poll using the command `PPC`. This command allocates a data line to the instrument and determines whether the response is to be inverted. The parallel poll itself is executed using `PPE`.

The parallel poll method is mainly used to find out quickly which one of the instruments connected to the controller has sent a service request. To this effect, `SRE` and `PPE` must be set to the same value.

6.5.5.4 Query of an instrument status

Each part of any status register can be read using queries. There are two types of commands:

- The common commands `*ESR?`, `*IDN?`, `*IST?`, `*STB?` query the higher-level registers.
- The commands of the `STATUS` system query the SCPI registers (`STATUS:QUESTIONABLE...`)

The returned value is always a decimal number that represents the bit pattern of the queried register. This number is evaluated by the controller program.

Queries are usually used after an `SRQ` in order to obtain more detailed information on the cause of the `SRQ`.

6.5.5.5 Error Queue

Each error state in the instrument leads to an entry in the error queue. The entries of the error queue are detailed plain text error messages that can be looked up in the Error Log or queried via remote control using `SYSTEM:ERROR[:NEXT]?` or `SYSTEM:ERROR:ALL?`. Each call of `SYSTEM:ERROR[:NEXT]?` provides one entry from the error queue. If no error messages are stored there any more, the instrument responds with 0, "No error".

The error queue should be queried after every `SRQ` in the controller program as the entries describe the cause of an error more precisely than the status registers. Especially in the test phase of a controller program the error queue should be queried regularly since faulty commands from the controller to the instrument are recorded there as well.

6.5.6 Reset Values of the Status Reporting System

The following table contains the different commands and events causing the status reporting system to be reset. None of the commands, except `*RST` and `SYSTEM:PRESet`, influence the functional instrument settings. In particular, `DCL` does not change the instrument settings.

Table 6-5: Resetting the status reporting system

Event	Switching on supply voltage Power-On-Status-Clear		DCL, SDC (Device Clear, Selected Device Clear)	*RST or SYS-Tem:PRE-Set	STA-Tus:PRE-Set	*CLS
	0	1				
Clear STB, ESR	-	yes	-	-	-	yes
Clear SRE, ESE	-	yes	-	-	-	-
Clear PPE	-	yes	-	-	-	-
Clear error queue	yes	yes	-	-	-	yes
Clear output buffer	yes	yes	yes	1)	1)	1)
Clear command processing and input buffer	yes	yes	yes	-	-	-

1) The first command in a command line that immediately follows a <PROGRAM MESSAGE TERMINATOR> clears the output buffer.

6.6 General Programming Recommendations

Initial instrument status before changing settings

Manual operation is designed for maximum possible operating convenience. In contrast, the priority of remote control is the "predictability" of the instrument status. Thus, when a command attempts to define incompatible settings, the command is ignored and the instrument status remains unchanged, i.e. other settings are not automatically adapted. Therefore, control programs should always define an initial instrument status (e.g. using the *RST command) and then implement the required settings.

Command sequence

As a general rule, send commands and queries in different program messages. Otherwise, the result of the query may vary depending on which operation is performed first (see also Preventing Overlapping Execution).

Reacting to malfunctions

The service request is the only possibility for the instrument to become active on its own. Each controller program should instruct the instrument to initiate a service request in case of malfunction. The program should react appropriately to the service request.

Error queues

The error queue should be queried after every service request in the controller program as the entries describe the cause of an error more precisely than the status registers. Especially in the test phase of a controller program the error queue should be queried

regularly since faulty commands from the controller to the instrument are recorded there as well.

7 Remote Control Commands

In the following, all remote-control commands will be presented in detail with their parameters and the ranges of numerical values.

For an introduction to remote control and the status registers, refer to [chapter 6, "Remote Control Basics"](#), on page 314.

7.1 Common Commands

Common commands are described in the IEEE 488.2 (IEC 625-2) standard. These commands have the same effect and are employed in the same way on different devices. The headers of these commands consist of "*" followed by three letters. Many common commands are related to the Status Reporting System.

Available common commands:

*CAL?	354
*CLS	354
*ESE	355
*ESR?	355
*IDN?	355
*IST?	355
*OPC	356
*OPT?	356
*PCB	356
*PRE	356
*PSC	356
*RCL	357
*RST	357
*SAV	357
*SRE	357
*STB?	358
*TRG	358
*TST?	358
*WAI	358

*CAL?

Calibration Query

Initiates a calibration of the instrument and subsequently queries the calibration status. Responses > 0 indicate errors.

Usage: Query only

*CLS

CLear Status

Sets the status byte (STB), the standard event register (ESR) and the `EVENT` part of the `QUESTIONABLE` and the `OPERATION` registers to zero. The command does not alter the mask and transition parts of the registers. It clears the output buffer.

Usage: Setting only

*ESE <Value>

Event Status Enable

Sets the event status enable register to the specified value. The query returns the contents of the event status enable register in decimal form.

Parameters:

<Value> Range: 0 to 255

*ESR?

Event Status Read

Returns the contents of the event status register in decimal form and subsequently sets the register to zero.

Return values:

<Contents> Range: 0 to 255

Usage: Query only

*IDN?

IDeNtification: returns the instrument identification.

Return values:

<ID> "Rohde&Schwarz,<device type>,<serial number>,<firmware version>"

Example: Rohde&Schwarz,ZVA8-4Port,12345,0.10.1.23

Usage: Query only

Manual control: See "[Hardware Options / Software Options](#)" on page 86

*IST?

Individual SStatus query

Returns the contents of the IST flag in decimal form. The IST flag is the status bit which is sent during a parallel poll.

Return values:

<ISTflag> 0 | 1

Usage: Query only

***OPC**

Operation Complete

Sets bit 0 in the event status register when all preceding commands have been executed. This bit can be used to initiate a service request. The query form writes a "1" into the output buffer as soon as all preceding commands have been executed. This is used for command synchronization.

***OPT?**

OPTion identification query

Queries the options included in the instrument. For a list of all available options and their description refer to the CD-ROM.

Return values:

<Options> The query returns a list of options. The options are returned at fixed positions in a comma-separated string. A zero is returned for options that are not installed.

Usage: Query only

Manual control: See "[Hardware Options / Software Options](#)" on page 86

***PCB <Address>**

Pass Control Back

Indicates the controller address to which remote control is returned after termination of the triggered action.

Setting parameters:

<Address> Range: 0 to 30

Usage: Setting only

***PRE <Value>**

Parallel poll Register Enable

Sets parallel poll enable register to the indicated value. The query returns the contents of the parallel poll enable register in decimal form.

Parameters:

<Value> Range: 0 to 255

***PSC <Action>**

Power on Status Clear

Determines whether the contents of the `ENABLe` registers are preserved or reset when the instrument is switched on. Thus a service request can be triggered when the instrument is switched on, if the status registers ESE and SRE are suitably configured. The query reads out the contents of the "power-on-status-clear" flag.

Parameters:

<Action> 0 | 1

0

The contents of the status registers are preserved.

1

Resets the status registers.

***RCL** <Number>

ReCaLI calls up the instrument settings from an intermediate memory identified by the specified number. The instrument settings can be stored to this memory using the command `*SAV` with the associated number.

It also activates the instrument settings which are stored in a file and loaded using the `MMEMory:LOAD <number>, <file_name.extension>` command.

Manual control: See "Recall" on page 111

***RST**

ReSeT

Sets the instrument to a defined default status. The default settings are indicated in the description of commands.

The command is equivalent to `SYSTem:PRESet`.

Usage: Setting only

Manual control: See "Preset" on page 81

***SAV** <Number>

SAVe stores the current instrument settings under the specified number in an intermediate memory. The settings can be recalled using the command `*RCL` with the associated number.

To transfer the stored instrument settings in a file, use the command `:MMEMory:STORe:STATe`.

Manual control: See "Save" on page 110

***SRE** <Contents>

Service Request Enable

Sets the service request enable register to the indicated value. This command determines under which conditions a service request is triggered.

Parameters:

<Contents> Contents of the service request enable register in decimal form.
 Bit 6 (MSS mask bit) is always 0.
 Range: 0 to 255

***STB?**

SStatus Byte query

Reads the contents of the status byte in decimal form.

Usage: Query only

***TRG**

TRiGger

Triggers all actions waiting for a trigger event. In particular, *TRG generates a manual trigger signal (Manual Trigger). This common command complements the commands of the TRIGger subsystem.

Usage: Event

***TST?**

self TeST query

Triggers selftests of the instrument and returns an error code in decimal form (see Service Manual supplied with the instrument). "0" indicates no errors occurred.

Usage: Query only

***WAI**

WAI to continue

Prevents servicing of the subsequent commands until all preceding commands have been executed and all signals have settled (see also command synchronization and [*OPC](#)).

Usage: Event

7.2 Preset Commands

The preset commands are not bundled in one subsystem. Therefore, they are listed separately in this section. In addition, a specific preset command is provided for each digital

standard and for the fader. These specific commands are described in the associated subsystems.

Four presetting actions are available:

- Activating the default state of all internal instrument functions (`*RST` on page 357). Functions that concern the integration of the instrument into a measurement setup are not changed, e.g. GPIB address or reference oscillator source settings.
- Activating the preset state of the parameters related to the selected signal path (`:SOURce<hw>:PRESet` on page 359)
- Activating the preset state of all parameters that are not related to the signal path (`:DEVIce:PRESet` on page 359)
- Activating the original state of delivery (factory reset, `:SYSTem:FPReset` on page 360). Only functions that are protected by a password remain unchanged as well as the passwords themselves.

:DEVIce:PRESet

The command presets all parameters which are not related to the signal path. This includes presetting the LF generator and bit/block error measurement.

Example: `DEV:PRESet`
presets all instruments settings that are not related to the signal path

Usage: Event

:SOURce<hw>:PRESet

The command presets all parameters which are related to the selected signal path.

Fading (if available) and transient recorder are only preset by command `*RST`.

Example: `SOUR:PRESet`
presets all settings that are related to signal path

SYSTem:PRESet

The command triggers an instrument reset. It has the same effect as:

- the PRESET key on the front panel
- the `*RST` command

For an overview of the settings affected by the preset function, see [chapter 5.2.2, "Default Instrument Settings - Preset Key"](#), on page 81.

Example: `SYST:PRESet`
All instrument settings (also those that are not currently active) are reset to their default values.

Usage: Setting only

:SYSTem:FPRreset

The command triggers an instrument reset to the original state of delivery.

Note: Since Factory Preset resets the Remote Channel and network settings to the default values, executing Factory Preset via remote control terminates the connection to the instrument, if these settings had been configured to values different to the default ones!

The factory preset function resets nearly all instrument settings. In addition to the regular preset by means of the PRESET key, a "Factory Preset" resets also the following values:

- Reference frequency settings ("Ref Oscillator" menu)
- Power on settings ("Level/EMF" menu)
- Network settings including hostname ("Setup" menu)
- Remote Channel settings including GPIB address ("Setup" menu)
- Start/Stop Gui Update ("Setup" menu)
- Display and keyboard settings ("Setup" menu).

To maintain security, password settings and all settings protected by these passwords like disabled USB and LAN connections are not changed.

Not affected by the "Factory Preset" are also user data, lists or instrument settings files, created for example by means of the Save/Recall function.

Example: `SYST:FPR`
all instrument settings (also those that are not currently active) are reset to the factory values.

Usage: Event

Manual control: See "Factory Preset" on page 103

7.3 CALibration Subsystem

The CALibration system contains the commands for adjustment. Adjustment is triggered by the query commands. The response "0" indicates error-free adjustment, and the response "1" means that an error occurred during adjustment.

<code>:CALibration:ALL[:MEASure]?</code>	361
<code>:CALibration:CSYNthesis[:MEASure]?</code>	361
<code>:CALibration:DME[:MEASure]?</code>	361
<code>:CALibration<hw>:FMOffset[:MEASure]?</code>	362
<code>:CALibration<hw>:FREQuency[:MEASure]?</code>	362
<code>:CALibration<hw>:LEVel[:MEASure]?</code>	362
<code>:CALibration<hw>:LEVel:EXTern:DATA</code>	362
<code>:CALibration:LFOutput[:MEASure]</code>	363

:CALibration:ALL[:MEASure]?

The command starts all internal adjustments for which no external measuring equipment is needed.

Return values:

<Measure> 0 | 1

Example:

CAL:ALL:MEAS?

starts the adjustment of all functions for the entire instrument.

Response: "0"

adjustment has been performed successfully.

Usage:

Query only
SCPI confirmed

Manual control:

See ["Adjust All"](#) on page 83

:CALibration:CSYNthesis[:MEASure]?

The command performs all adjustments which affect the clock synthesis.

Return values:

<Measure> 0 | 1 | OFF | ON

Example:

CAL:CSYN?

starts the adjustment of all functions for the entire instrument.

Response: 0

adjustment has been performed successfully.

Usage:

Query only
SCPI confirmed

Options:

R&S SMA-B29

Manual control:

See ["Adjust Clock Synthesis"](#) on page 84

:CALibration:DME[:MEASure]?

The command starts internal adjustment of the DME pulse slope for best linearity.

Return values:

<Measure> 0 | 1 | OFF | ON

*RST: 0

Example:

CAL:DME?

starts the adjustments of the DME pulse slope for best linearity.

Response: 0

the adjustments have been performed successfully.

Usage:

Query only

Manual control:

See ["Adjust DME Pulse Slope"](#) on page 84

:CALibration<hw>:FMOffset[:MEASure]?

The command starts all adjustment for the FM/PhiM modulator.

Return values:

<Measure> 0 | 1

Example:

CAL:FMOF?

starts the adjustments for the FM/Phim modulator.

Response: "0"

the adjustments have been performed successfully

Usage:

Query only

Options:

R&S SMA-B20 or R&S SMA-B22

Manual control:

See "[Adjust FM Offset](#)" on page 221

:CALibration<hw>:FREQuency[:MEASure]?

The command starts all adjustments which affect the frequency.

Return values:

<Measure> 0 | 1

Example:

CAL:FREQ:MEAS?

starts the adjustments for maximum frequency accuracy.

Response: "0"

the adjustments have been performed successfully.

Usage:

Query only

Manual control:

See "[Adjust Synthesis](#)" on page 83

:CALibration<hw>:LEVel[:MEASure]?

The command starts level adjustment in the mixer range. The acquired correction values are only used with FM/PhiM or Pulse modulation

Return values:

<Measure> 0 | 1

Example:

CAL:LEV:MEAS?

starts the level adjustment in the mixer range.

Response: "0"

adjustment has been performed successfully.

Usage:

Query only

Manual control:

See "[Adjust Level](#)" on page 84

:CALibration<hw>:LEVel:EXTern:DATA <Data>

Selects the data used for of external level correction.

By default the instrument uses correction data obtained in the factory before delivery. In addition, customer data can be used for external level correction. The customer data is obtained using a R&S NRP power sensor. External level correction is a protected function (see service manual, chapter 2, "Adjustment").

Parameters:

<Data> FACT | CUST
*RST: FACTory

Example:

CAL:LEV:EXT:DATA FACT
selects the use of the data acquired at the factory for external level correction.

Manual control: See "[Adjustment Data](#)" on page 84

:CALibration:LFOutput[:MEASure] <Measure>

Performs all adjustments which affect the internal modulation generator.

Parameters:

<Measure>

Example:

CAL:LFO?
starts the adjustments for the modulation generators.
Response: 0
the adjustments have been performed successfully.

Manual control: See "[Adjust LF Gen/Mod Gen](#)" on page 84

7.4 CSYNthesis Subsystem

This subsystem contains the commands used to define the frequency settings for the separate clock source (Clock Synthesis).

:CSYNthesis:FREQuency.....	363
:CSYNthesis:STATe.....	364
:CSYNthesis:FREQuency:STEP.....	364
:CSYNthesis:FREQuency:STEP:MODE.....	365
:CSYNthesis:OFFSet.....	365
:CSYNthesis:OFFSet:STATe.....	365

:CSYNthesis:FREQuency <Frequency>

The command sets the frequency of the clock synthesis output signal.

In addition to a numerical value, it is also possible to specify UP and DOWN. The frequency is then increased or decreased by the value which is set under CSYNthesis:FREQuency:STEP.

Parameters:

<Frequency> float
 Range: 100 kHz to 1.5 GHz
 Increment: 0.01 Hz
 *RST: 10 MHz
 Default unit: Hz

Example:

CSYN:FREQ 500kHz
 sets the frequency of clock synthesis signal to 500kHz.

Options:

R&S SMA-B29

Manual control:

See "[Frequency - Clock Synthesis](#)" on page 312

:CSYNthesis:STATe <State>

The command activates/deactivates generation of a system clock for differential outputs CLK SYN and CLK SYN N at the rear of the instrument

Parameters:

<State> 0 | 1 | OFF | ON
 *RST: OFF

Example:

CSYN:STAT ON
 a clock signal with the set frequency is output.

Options:

R&S SMA-B29

Manual control:

See "[State - Clock Synthesis](#)" on page 312

:CSYNthesis:FREQuency:STEP <Step>

The command sets the step width for the clock synthesis frequency setting if the frequency values UP/DOWN are used and variation mode SOUR:FREQ:STEP:MODE USER is selected. The command is linked to "Variation Step" for manual control, i.e. the command also sets the step width of the rotary knob for "Variation Active on".

Parameters:

<Step> float
 Range: 0 Hz to RFmax - 100 KHz
 Increment: 0.001 Hz
 *RST: 1 MHz
 Default unit: Hz

Example:

CSYN:FREQ:STEP 50 kHz
 sets the step width for the clock synthesis frequency setting to 50 kHz.

Options:

R&S SMA-B29

Manual control:

See "[Variation Step - Clock Synthesis](#)" on page 313

:CSYNthesis:FREQuency:STEP:MODE <Mode>

This command activates (USER) or deactivates (DECimal) the user-defined step width used when varying the clock synthesis frequency value with the frequency values UP/DOWN. The command is linked to the command "Variation Active" for manual control, i.e. the command also activates/deactivates the user-defined step width used when varying the frequency value with the rotary knob.

Parameters:

<Mode> DECimal | USER
 *RST: DECimal

Example:

CSYN:FREQ:STEP 50 kHz
 sets the step width for the clock synthesis frequency setting to 50 kHz.
 CSYN:FREQ:STEP:MODE USER
 activates this step width for clock synthesis frequency variation with the rotary knob (manual control) and with frequency values UP/DOWN (remote control).

Options: R&S SMA-B29

Manual control: See "[Variation Active](#)" on page 313

:CSYNthesis:OFFSet <Offset>

The command enters a DC offset which is added to both clock synthesis output signals.

Parameters:

<Offset> float
 Range: -5 V to +5 V
 Increment: 10 mV
 *RST: 0 V
 Default unit: V

Example:

CSYN:OFFS 0.25V
 sets a DC offset of 0.25 volts

Manual control: See "[DC Offset - Clock Synthesis](#)" on page 312

:CSYNthesis:OFFSet:STATe <State>

The command activates the addition of the DC offset to both clock synthesis output signals. The DC offset value is set with command CSYNthesis:OFFSet.

Parameters:

<State> 0 | 1 | OFF | ON
 *RST: OFF

Example:

CSYN:OFFS 0.4V
 sets a DC offset of 0.4V
 CSYN:OFFS:STAT ON
 a DC offset of 0.4V is added to the clock signal

Manual control: See "State DC Offset - Clock Synthesis" on page 312

7.5 DIAGnostic Subsystem

The `DIAGnostic` system contains the commands used for instrument diagnosis and servicing. SCPI does not define any `DIAGnostic` commands; the commands listed here are all Device-specific. All `DIAGnostic` commands are query commands which are not influenced by `*RST`.

<code>:DIAGnostic<hw>:BGInfo?</code>	366
<code>:DIAGnostic<hw>:BGInfo:CATalog?</code>	366
<code>:DIAGnostic:INFO:OTIMe?</code>	367
<code>:DIAGnostic:INFO:POCount?</code>	367

`:DIAGnostic<hw>:BGInfo?`

The command checks the modules available in the instrument using the variant and revision state.

If the command is sent without parameters being specified, a complete list of all modules is returned (the various entries are separated by commas). The length of the list is variable and depends on the instrument equipment configuration.

If the command is sent with parameters, a list of the specified modules is returned (the various entries are separated by commas). A list of modules names can be called up using the command `:DIAGnostic<hw>:BGInfo:CATalog?` on page 366.

Return values:

`<Bginfo>` `<Module name> <Module stock number incl. variant> <Module revision> <Module serial number>`

Each entry for one module consists of four parts which are separated by space characters.

Example:

```
DIAG:BGIN
Queries the instrument configuration.
Response: MBRD,SSYN, . . . .
returns the data of all available modules.
DIAG:BGIN? 'MBRD'
Queries the configuration of the motherboard.
Response:          MBRD 1141.3501.02 1.5.3 100023
Module motherboard with stock number 1141.3501.01 has revision 1.5.3 and serial number 100023.
```

Usage: Query only

Manual control: See "Assembly" on page 85

`:DIAGnostic<hw>:BGInfo:CATalog?`

The command queries the names of the assemblies available in the instrument.

A complete list of all assemblies is returned (the various entries are separated by commas). The length of the list is variable and depends on the instrument equipment configuration.

Return values:

<Catalog> string

Example:

DIAG:BGIN:CAT
queries the names of the assemblies.
Response: MBRD,SSYN,

Usage: Query only

:DIAGnostic:INFO:OTIMe?

The command queries the number of operation hours.

Return values:

<OTIMe> float

Example:

DIAG:INFO:OTIM
queries the operation hours.
Response: 100023
The instrument was operated for 100023 hours up to now.

Usage: Query only

Manual control: See "[Operation Time / h](#)" on page 85

:DIAGnostic:INFO:POCount?

The command queries the number of power-on events.

Return values:

<Pocount> float

Example:

DIAG:INFO:POC
queries the number of power on events.
Response: 123
The instrument was switched on for 123 times up to now.

Usage: Query only

Manual control: See "[Power On Count](#)" on page 85

7.6 DISPlay Subsystem

The DISPlay subsystem contains the commands to set the power-save mode of the instrument.

:DISPlay:ANNotation:AMPLitude	368
:DISPlay:ANNotation:FREQuency	368
:DISPlay:ANNotation[:ALL]	368

:DISPlay:DIALog:CLoSe.....	368
:DISPlay:DIALog:ID.....	369
:DISPlay:DIALog:OPEN.....	369
:DISPlay:PSAVe:HOLDoff.....	369
:DISPlay:PSAVe[:STATe].....	370

:DISPlay:ANNotation:AMPLitude <State>

Fades out level display in the header of the instrument and displays asterisks instead.

Parameters:

<State> 0 | 1 | OFF | ON
 *RST: 1

Example: DISP:ANN:AMPL ON
 shows asterisks instead of level values.

Manual control: See "[Annotation Amplitude](#)" on page 101

:DISPlay:ANNotation:FREQuency <State>

Fades out frequency display in the header of the instrument and displays asterisks instead.

Parameters:

<State> 0 | 1 | OFF | ON
 *RST: 1

Example: DISP:ANN:FREQ ON
 shows asterisks instead of the frequency.

Manual control: See "[Annotation Frequency](#)" on page 101

:DISPlay:ANNotation[:ALL] <State>

Fades out level and frequency display in the header of the instrument and displays asterisks instead. These settings are particularly useful when you remotely control the instrument.

Parameters:

<State> 0 | 1 | OFF | ON
 *RST: 1

Example: DISP:ANN:AMPL ON
 shows asterisks instead of frequency and level values.

:DISPlay:DIALog:CLoSe <DialogId>

Closes the specified dialog. To determine the dialog identifier, use command :
[DISPlay:DIALog:ID](#).

Setting parameters:

<DialogId> string

Example:

DISP:DIAL:CLOS "<dialog ID>"
closes the dialog, determined with the "<dialog ID>".

Usage:

Setting only

:DISPlay:DIALog:ID

Returns the dialog identifiers of the open dialogs in a string separated by blanks.

Parameters:

<DialogIdList> string

Example:

DISP:DIAL:ID?
Response: "<dialog ID(1)> <dialog ID(2)> ...
<dialog ID(n)>"
returns the Ids of all opened dialogs.

:DISPlay:DIALog:OPEN <DialogId>

Opens the specified dialog. To determine the dialog identifier, use command :
[DISPlay:DIALog:ID](#).

Setting parameters:

<DialogId> string

Example:

DISP:DIAL:OPEN "<dialog ID>"
opens the dialog, determined with the "<dialog ID>".

Usage:

Setting only

:DISPlay:PSAVe:HOLDoff <Holdoff>

Sets the waiting time for the screen-save mode of the display. The entry is dimensionless.

Parameters:

<Holdoff> integer
Range: 1 to 60
*RST: 10
Default unit: minute

Example:

DISP:PSAV:HOLD 8
sets the timeout of the screen saver to 8 minutes.

Manual control:

See "[Wait Time](#)" on page 94

:DISPlay:PSAVe[:STATe] <State>

Activates the screen-save mode of the display. If activated, the display including backlight is completely switched off after the elapse of the wait time, provided no entries via front panel, external mouse or external keyboard are made. To determine the wait time, use command `:DISPlay:PSAVe:HOLDoff`.

This mode is recommended for protecting the display, especially if the instrument is operated via remote control.

Parameters:

<State> 0 | 1 | OFF | ON
*RST: OFF

Example: DISP:PSAV ON
 activates screen saver mode.

Manual control: See "Screen Saver Active" on page 93

7.7 FORMat Subsystem

The FORMat subsystem contains the commands which determine the format of the data that the R&S SMA returns to the controller. This affects all query commands which return a list of numerical data or block data. Reference is made to this in the descriptions of the commands.

<code>:FORMat:BORDER</code>	370
<code>:FORMat[:DATA]</code>	371
<code>:FORMat:SREGister</code>	371

:FORMat:BORDER <Border>

The command determines the sequence of bytes within a binary block. This only affects blocks which use the IEEE754 format internally.

Parameters:

<Border> NORMal | SWAPped

NORMal

The instrument expects (with setting commands) and sends (with queries) the least significant byte of each IEEE754 floating-point number first and the most significant byte last.

SWAPped

The instrument expects (with setting commands) and sends (with queries) the most significant byte of each IEEE754 floating-point number first and the least significant byte last.

*RST: NORMal

Example: FORM:BORD SWAP
 the data is transferred with the most significant bit first.

:FORMat[:DATA] <Data>

The command determines the data format which the R&S Signal Generator uses to return data. When data is transferred from the control computer to the instrument, the instrument detects the data format automatically. In this case, the value set here is irrelevant.

Parameters:

<Data> ASCII | PACKed

ASCII

Numerical data is transferred as plain text separated by commas.

PACKed

Numerical data is transferred as binary block data. The format within the binary data depends on the command. The various binary data formats are explained in the description of the parameter types.

*RST: ASCII

Example:

FORM ASC

The data is transferred as ASCII data.

:FORMat:SREGister <Sregister>

The command determines the numerical format which is returned when the status registers are queried.

Parameters:

<Sregister> ASCII | BINary | HEXadecimal | OCTal

ASCII

The register content is returned as a decimal number.

BINary

The register content is returned as a binary number. #B is placed in front of the number.

HEXadecimal

The register content is returned as a hexadecimal number. #H is placed in front of the number.

OCTal

The register content is returned as an octal number. #Q is placed in front of the number.

*RST: ASCII

Example:

FORM:SREG HEX

The register content is returned as a hexadecimal number.

7.8 HCOPY Subsystem

The HCOPY subsystem contains the commands to generate a hardcopy of the display.

:HCOPY:DATA?	372
:HCOPY:DEvice	372
:HCOPY:DEvice:LANGuage	373
:HCOPY[:EXECute]	373
:HCOPY:FILE[:NAME]	373
:HCOPY:FILE[:NAME]:AUTO?	374
:HCOPY:FILE[:NAME]:AUTO:DIRectory	374
:HCOPY:FILE[:NAME]:AUTO:DIRectory:CLEar	374
:HCOPY:FILE[:NAME]:AUTO:FILE?	375
:HCOPY:FILE[:NAME]:AUTO[:FILE]:DAY?	375
:HCOPY:FILE[:NAME]:AUTO[:FILE]:DAY:STATe	375
:HCOPY:FILE[:NAME]:AUTO[:FILE]:MONTH?	376
:HCOPY:FILE[:NAME]:AUTO[:FILE]:MONTH:STATe	376
:HCOPY:FILE[:NAME]:AUTO[:FILE]:NUMBer?	376
:HCOPY:FILE[:NAME]:AUTO[:FILE]:PREFix	377
:HCOPY:FILE[:NAME]:AUTO[:FILE]:PREFix:STATe	377
:HCOPY:FILE[:NAME]:AUTO[:FILE]:YEAR?	377
:HCOPY:FILE[:NAME]:AUTO[:FILE]:YEAR:STATe	377
:HCOPY:FILE[:NAME]:AUTO:STATe	378
:HCOPY:IMAGe:FORMat	378
:HCOPY:IMAGe:SIZE	378

:HCOPY:DATA?

The commands transfers the hardcopy data directly as a NByte stream to the remote client.

Return values:

<Data> string

Example:

```
HCOP:DEV:LANG JPG
HCOP:DATA?
```

transfers the hardcopy to the remote client.

Usage:

Query only

:HCOPY:DEvice <Device>

The command defines the output device. The hardcopy can be output in a file. The `HCOPY:FILE:...` commands are used for configuration. The file is accessible using the `MMEM:..` commands. In addition, the hardcopy data can be directly transferred to the remote client using command `:HCOPY:DATA?`.

Parameters:

<Device> FILE
 *RST: FILE

Example:

```
HCOP:DEV FILE
```

the hardcopy will be stored in a file.

Manual control:

See "[Destination](#)" on page 104

:HCOPY:DEVice:LANGUage <Language>

The command selects the bitmap graphic format for the screenshot. It is also possible to directly retrieve the data using command `HCOPY:DATA?`. This command is an alias to command `HCOPY:IMAGE:FORMat`.

Parameters:

<Language> BMP | JPG | XPM | PNG
*RST: BMP

Example:

```
HCOPY:DEV:LANG BMP
selects bitmap as image format.
HCOPY:FILE '/usb/HCopy'
defines the directory, path and file name for storing the hardcopy.
HCOPY
triggers the hardcopy generation.
```

Manual control: See ["File Options"](#) on page 105

:HCOPY[:EXECute]

The command triggers the generation of a hardcopy.

The data is written into the file selected/created with the `HCOPY:FILE` commands.

Example:

```
HCOPY
triggers the generation of a hardcopy of the current display.
```

Usage:

Event

Manual control: See ["Save"](#) on page 107

:HCOPY:FILE[:NAME] <Name>

This command creates/selects a file into which the hardcopy will be stored. The path is specified together with the file name. Access to the file via remote control is possible using the commands of the MMEM-Subsystem. In contrast, command `HCOPY:DATA?` transfers the hardcopy contents directly to the remote client where they can be further processed.

If automatic file naming is activated, the hardcopy is stored into a file with an automatically generated name (commands `HCOPY:FILE[:NAME]:AUTO:...`).

Parameters:

<Name> string

Example:

```
HCOPY:FILE:NAME '/usb/HCopy'
defines the hardcopy file name.
```

Manual control: See ["File Info"](#) on page 105

:HCOPY:FILE[:NAME]:AUTO?

This command queries the path including the file name of the file with automatically generated name.

Return values:

<Auto> string

Example:

```
HCOP:DEV:LANG BMP
selects output format *,bmp.
HCOP:FILE:AUTO:DIR '/usb/HCopy'
defines the destination directory '/usb/HCopy'.
HCOP:FILE:AUTO:PREF 'gen'
the file name starts with the prefix 'gen'. The usage of automatic
naming with prefix and date in the file name is preset (...:STAT
ON).
HCOP
triggers the generation of a hardcopy of the current trace.
HCOP:FILE:AUTO?
queries the path including the file name
Response:
/usb/HCopy/gen101012008001.bmp'
```

Usage: Query only

Manual control: See "[File Options](#)" on page 105

:HCOPY:FILE[:NAME]:AUTO:DIRectory <Directory>

This command defines the directory into which the hardcopy files will be stored if auto naming is activated (HCOP:FILE:AUTO:STAT ON). The directory will be created if it does not exist yet.

Parameters:

<Directory> string
*RST: .\HCopy

Example: HCOP:FILE:AUTO:DIR '/usb/HCopy'
defines the destination directory '/usb/HCopy'

Manual control: See "[File Options](#)" on page 105

:HCOPY:FILE[:NAME]:AUTO:DIRectory:CLEar

This command deletes all files with extensions "bmp", "img", "png" and "xpm" in the directory set for automatic naming.

Example: HCOP:FILE:AUTO:DIR:CLE
deletes all image files with extensions "bmp", "img", "png" and "xpm".

Usage: Event

Manual control: See ["File Options"](#) on page 105

:HCOPY:FILE[:NAME]:AUTO:FILE?

This command queries the file name that what generated using the automatic naming settings. By default the automatically generated file name is composed of:

<Prefix><YYYY><MM><DD><Number>.<Format>.

Each component can be deactivated/activated separately to individually design the file name.

Return values:

<File> string

Example:

```
HCOP:DEV:LANG BMP
selects output format *.bmp.
HCOP:FILE:AUTO:DIR '/usb/HCopy'
defines the destination directory '/usb/HCopy'
HCOP:FILE:AUTO:PREF 'gen'
the file name starts with the prefix 'gen'. The usage of automatic
naming with prefix and date in the file name is preset (...:STAT
ON).
HCOP
triggers the generation of a hardcopy of the current trace.
HCOP:FILE:AUTO:FILE?
queries the file name
Response: 'gen101012008001.bmp'
```

Usage: Query only

Manual control: See ["File Info"](#) on page 105

:HCOPY:FILE[:NAME]:AUTO[:FILE]:DAY?

The command returns the day of the current system date which will be used in the file name if automatic naming is activated.

Return values:

<Day> float

Example:

```
HCOP:FILE:AUTO:DAY?
returns the day in the date part of the automatic file name.
```

Usage: Query only

:HCOPY:FILE[:NAME]:AUTO[:FILE]:DAY:STATe <State>

This command activates the usage of the day in the automatic file name.

Parameters:

<State> 0 | 1 | OFF | ON

*RST: ON

Example: `HCOP:FILE:AUTO:DAY:STAT OFF`
deactivates the use of the day in the automatically generated file name.

Manual control: See ["File Options"](#) on page 105

:HCOPY:FILE[:NAME]:AUTO[:FILE]:MONTH?

This command queries the month in the date part in the automatic file name.

Return values:

<Month> float

Example: `HCOP:FILE:AUTO:MONTH?`
queries the month in the date part in the automatic file name.

Usage: Query only

:HCOPY:FILE[:NAME]:AUTO[:FILE]:MONTH:STATe <State>

This command activates the usage of the month in the automatic file name.

Parameters:

<State> 0 | 1 | OFF | ON
*RST: ON

Example: `HCOP:FILE:AUTO:MONTH:STAT OFF`
deactivates the usage of the month in the automatic file name.

Manual control: See ["File Options"](#) on page 105

:HCOPY:FILE[:NAME]:AUTO[:FILE]:NUMBER?

This command queries the number in the automatic file name. The number is assigned in such a way that always the lowest possible value for an unique file name within the selected path is used.

On initially switching on the device the number will be reset to the lowest possible value. Starting with number 0 the output directory will be scanned for already existing files. As long as files with the same name are existing the number will be incremented by 1. The number will be automatically set to a number so that the resulting file name will be unique within the selected path. The current number will not be saved in the save recall file but will be temporarily stored within the database. On subsequent saves the number will be incremented.

Return values:

<Number> float

Example: `HCOP:FILE:AUTO:NUMBER?`
queries the number in the automatic file name.

Usage: Query only

Manual control: See ["File Options"](#) on page 105

:HCOPY:FILE[:NAME]:AUTO[:FILE]:PREFIX <Prefix>

This command defines the prefix part in the automatic file name. The usage of the prefix is activated with command `HCOPY:FILE:AUTO:PREFIX:STAT ON`.

Parameters:

<Prefix> string
*RST: HCopy

Example: `HCOPY:FILE:AUTO:PREFIX 'Snapshot'`
appends "Snapshot" as prefix to the generated file name.

Manual control: See ["File Options"](#) on page 105

:HCOPY:FILE[:NAME]:AUTO[:FILE]:PREFIX:STATE <State>

This command activates the usage of the prefix in the automatic file name. The prefix is entered with command `HCOPY:FILE:AUTO:PREFIX`.

Parameters:

<State> 0 | 1 | OFF | ON
*RST: ON

Example: `HCOPY:FILE:AUTO:PREFIX:STAT OFF`
deactivates the usage of the prefix in the automatic file name.

Manual control: See ["File Options"](#) on page 105

:HCOPY:FILE[:NAME]:AUTO[:FILE]:YEAR?

This command queries the year in the date part in the automatic file name.

Return values:

<Year> float

Example: `HCOPY:FILE:AUTO:YEAR?`
queries the year in the date part in the automatic file name.

Usage: Query only

:HCOPY:FILE[:NAME]:AUTO[:FILE]:YEAR:STATE <State>

This command activates the usage of the year in the automatic file name.

Parameters:

<State> 0 | 1 | OFF | ON
*RST: ON

Example: `HCOPY:FILE:AUTO:YEAR:STAT OFF`
deactivates the usage of the year in the automatic file name.

Manual control: See ["File Options"](#) on page 105

:HCOPY:FILE[:NAME]:AUTO:STATe <State>

This command activates/deactivates automatic naming of the hardcopy files.

Parameters:

<State> 0 | 1 | OFF | ON
*RST: ON

Example:

HCOPY:FILE:AUTO:STAT OFF
deactivates automatic naming.

Manual control: See "[Automatic Naming](#)" on page 104

:HCOPY:IMAGe:FORMat <Format>

This command selects the bitmap graphic format for the screenshot. It is also possible to directly retrieve the data using command `HCOPY:DATA?`.

This command is an alias to command `HCOPY:DEVIce:LANGUage`.

Parameters:

<Format> BMP | JPG | XPM | PNG
*RST: BMP

Example:

HCOPY:IMAG:FORM XPM
selects the image format XPM.

:HCOPY:IMAGe:SIZE <Size>

The command selects the image size of the hardcopy. The first value of the size setting defines the width, the second value the height of the image.

Parameters:

<Size> 320,640 | 640,480 | 800,600 | 1024,768
*RST: depends on device

Example:

HCOPY:IMAG:SIZE 640,480
sets width and height of the image.

Manual control: See "[File Options](#)" on page 105

7.9 KBOard Subsystem

The KBOard system contains the commands to set the external keyboard.

[:KBOard:LANGUage](#).....379
[:KBOard:LAYout?](#).....379

:KBOard:LANGUage <Language>

This command selects the keyboard language. The assignment of some keys depends on the selected language.

Parameters:

<Language> US | DE
*RST: US

Example:

KBO:LANG US
selects keyboard language American English.

Usage:

SCPI confirmed

Manual control:

See "[Layout \(Keyboard\)](#)" on page 94

:KBOard:LAYout?

This command selects the keyboard language. The assignment of some keys depends on the selected language.

Return values:

<Layout> CHINese | DANish | DUTCh | ENGUK | ENGUS | FINNish |
FRENch | FREBe | FRECa | GERMan | ITALian | JAPanese |
KOREan | NORWegian | PORTuguese | RUSSian | SPANish |
SWEDish
*RST: US

Example:

KBO:LAY US
activates American keyboard layout.

Usage:

Query only
SCPI confirmed

Manual control:

See "[Layout \(Keyboard\)](#)" on page 94

7.10 MMEMory Subsystem

The MMEMory subsystem (**Mass Memory**) contains the commands for managing files and directories as well as for loading and storing complete instrument settings in files.

The files are stored on the CompactFlash™ Card of the instrument or on external USB memory devices.

The `/var` directory can be used to save user-defined data; any subdirectory structure can be created on `/var`. Some default subdirectories are predefined, but can be changed at any time.

The default directory is determined using the command `MMEMory:CDIR`.



The `/opt` directory is a protected and therefore inaccessible system directory. The files on this directory contain data that must not be changed. Therefore, this directory should not be accessed, since reconstruction of the system partition will lead to data loss.

7.10.1 File Naming Conventions

To enable files in different file systems to be used, the following file naming conventions should be observed.

The file name can be of any length and is case-sensitive, i.e it is distinguished between uppercase and lowercase letters.

The file and the optional file extension are separated by a dot. All letters and numbers are permitted (numbers are, however, not permitted at the beginning of the file name). Where possible, special characters should not be used. Use of the slashes "\" and "/" should be avoided since they are used in file paths. A number of names are reserved by the operating system, e.g. `CLOCK$`, `CON`, `AUX`, `COM1 . . . COM4`, `LPT1 . . . LPT3`, `NUL` and `PRN`.

In the R&S Signal Generator all files in which lists and settings are stored are given a characteristic extension. The extension is separated from the actual file name by a dot (see [chapter 4.7.2.1, "Extensions for User Files"](#), on page 75 for an overview the file types).

The two characters "*" and "?" function as "wildcards", i.e. they are used for selecting several files. The "?" character represents exactly one character, while the "*" character represents all characters up to the end of the file name. "*.*" therefore stands for all the files in a directory.

When used in conjunction with the commands, the parameter `<file_name>` is specified as a string parameter with quotation marks. It can contain either the complete path including the drive, only the path and file name, or only the file name. The file name must include the file extension. The same applies for the parameters `<directory_name>` and `<path>`.

Depending on how much information is provided, either the values specified in the parameter or the values specified with the command `MMEM:CDIR` (default directory) are used for the path and drive setting in the commands.

Before the instrument settings can be stored in a file, they have to be stored in an intermediate memory using common command `*SAV <number>`. The specified number is subsequently used in the `:MMEMory:STORe:STATe` command. Also, subsequently to loading a file with instrument settings with command `:MMEMory:LOAD:STATe`, these settings have to be activated with the common command `*RCL <number>`.

7.10.2 Extensions for User Files

The following table list all available file extensions for user files. The currently available files on the instrument depends on the installed options.

Table 7-1: List of the automatically assigned file extensions in the instrument

Function	List type	Contents	File suffix
Instrument State	Settings	Instrument settings	*.savrltxt
"User Correction"	List	User-defined level correction values	*.uco
		Export Data	*.txt or *.csv
"List Mode"	List	User-defined frequency/level value pairs	*.lsw
		Export Data	*.txt or *.csv
"Pulse Train List"		User-defined offtime/ontime/repetition values	*.pulstrn
NRP Settings	Settings	NRP Settings	*.nrp

7.10.3 Examples

In these examples, the current instrument setting is stored in the file `test1.savrltxt` in the directory `user`.

Storing and Loading Current Settings

1. Store the current setting in an intermediate memory with number 4. This setting can be called using command `*RCL` and the associated number of the memory, e.g. `*RCL 4`.
`*SAV 4`
2. To store the settings in a file in a specific directory, specify the complete path.
`MMEM:STOR:STAT 4,"var/user/test.savrltxt"`
3. To store the settings in a file in the default drive, set the default drive and specify only the file name.
`MMEM:CDIR 'var/user'*SAV 4`
`MMEM:STOR:STAT 4,"test.savrltxt"`
4. Load the file `test.savrltxt` in the `user` directory.
`MMEM:LOAD:STAT 4,'/var/user/test.savrltxt'`
5. Activate the instrument setting of the file `test.savrltxt`.
`*RCL 4`

Working with Files and Directories

1. Read out all files in the specified directory.
`MMEM:CAT? '/usb/user'`

Response: `127145265,175325184,"test,DIR,0","temp,DIR,0","readme.txt,ASC,1324","state.savrltxt,STAT,5327","waveform.wv,BIN,2342"`

the directory `/usb/user` contains the subdirectories `test` and `temp` as well as the files `readme.txt`, `state.savrcltxt` and `waveform.wv` which have different file types.

Tip: To query only the subdirectories of the current or specified directory, perform:

```
MMEM:DCAT? '/usb/user'
```

Response: 'test', 'temp'

To query only the number of subdirectories in the current or specified directory, perform:

```
MMEM:DCAT:LENG? '/usb/user'
```

Response: 2

2. To query the number of files in the current or specified directory, perform:

```
MMEM:CAT:LENG? '/usb/user'
```

Response: 3

3. Create a new subdirectory for mass memory storage in the specified directory.

```
MMEM:MDIR '/usb/user/new'
```

4. Copy the file `state` to a new file.

```
MMEM:COPY '/var/user/state.savrcltxt', '/usb/user/new'
```

5. Rename the file `state`.

```
MMEM:MOVE 'state.savrcltxt', 'state_new.savrcltxt'
```

6. Remove the `test` directory.

```
MMEM:RDIR '/usb/user/test'
```

7.10.4 Remote Control Commands

:MMEMory:CATalog?	382
:MMEMory:CATalog:LENGth?	383
:MMEMory:CDIRectory	383
:MMEMory:COPI	384
:MMEMory:DATA	384
:MMEMory:DCATalog?	385
:MMEMory:DCATalog:LENGth?	385
:MMEMory:DELe	385
:MMEMory:LOAD:STATe	386
:MMEMory:MDIRectory	386
:MMEMory:MOVE	386
:MMEMory:MSIS	387
:MMEMory:RDIRectory	387
:MMEMory:STORe:STATe	387

:MMEMory:CATalog? <path>

Returns the content of the current or a specified directory.

Query parameters:

<path> string
String parameter to specify the directory. If the directory is omitted, the command queries the content of the current directory, queried with `MMEM:CDIR` command.

Return values:

<path> <used_memory>,<free_memory>,<file_name>,<file_entry>,...
<used_memory>
Total amount of storage currently used in the directory, in bytes.
<free_memory>
Total amount of storage available in the directory, in bytes.
<file_entry>
All files of the directory are listed with their file name, format and size in bytes.

Example: See "[Working with Files and Directories](#)" on page 381.

Usage: Query only

Manual control: See "[File List](#)" on page 110

:MMEMory:CATalog:LENGth?

Returns the number of files in the current or in the specified directory.

Return values:

<Length> <path>
String parameter to specify the directory. If the directory is omitted, the command queries the content of the current directory, queried with `MMEM:CDIR` command.

<count> Number of files

Example: See "[Working with Files and Directories](#)" on page 381.

Usage: Query only

:MMEMory:CDIRectory <Cdirectory>

Changes the default directory for mass memory storage. The directory is used for all subsequent `MMEM` commands if no path is specified with them. It is also possible to change to a higher directory using two dots '..'.

Setting parameters:

<Cdirectory> <directory_name>

Example: See "[Working with Files and Directories](#)" on page 381.

Usage: Setting only
SCPI confirmed

Manual control: See "[Directory](#)" on page 109

:MMEMory:COPY <file_source>[,<file_destination>]

Copies an existing to a new file. Instead of just a file, this command can also be used to copy a complete directory together with all its files.

It is also possible to specify the path using another parameter. The command is:

```
MMEMory:COPY
<file_source><msus_source>[,<file_destination>,
<msus_destination>]
```

Setting parameters:

<file_source>	string String parameter to specify the name of the file to be copied. If <destination> is not specified, <source> is copied to the MMEM:CDIR directory. Files which already exist with the same name in the destination directory are overwritten without an error message. It is also possible to specify the path using another parameter. The command is: MMEMory:COPY <file_source><msus_source>[,<file_destination>,<msus_destination>]
file_destination	string String parameter to specify the name of the new file. If no file destination is specified, the source file is copied to the current directory, queried with the MMEM:CDIR command. Files which already exist with the same name in the destination directory are overwritten without an error message.

Example: See "[Working with Files and Directories](#)" on page 381.

Usage: Event
SCPI confirmed

Manual control: See "[Copy](#)" on page 113

:MMEMory:DATA <file_name>[,<binary block data>]

:MMEMory:DATA? <file_name>

Writes the block data <binary block data> to the file identified by <file_name>. The IEC/IEEE-bus terminator should be set to EOI in order to ensure correct data transfer.

The associated query command transfers the specified file from the instrument to the IEC/IEEE bus and then on to the control computer. It is important to ensure that the intermediate memory on the control computer is large enough to take the file. In this case, the setting for the IEC/IEEE-bus terminator is irrelevant. This command can be used to read/transfer stored instrument settings or waveforms directly from/to the instrument.

Parameters:

<file_name>	String parameter to specify the name of the file.
--------------------------	---

Setting parameters:

<binary block data> #<number><length entry><block data>
 # always comes first in the binary block
 <number> the first digit indicates how many digits the subsequent length entry has
 <length entry> indicates the number of subsequent bytes
 <binary block data> binary block data for the specified length.

Example:

```
MMEM:DATA 'TEST1.WV',#3767<binary data>
writes the block data to the file test1.wv.
The digit "3" indicates a length entry of 3 digits; the digits "767"
indicate a length of the binary data in bytes.
MMEM:DATA? 'TEST1.WV'
sends the data of the file Test1.wv from the instrument to the
controller in the form of a binary block.
```

:MMEMory:DCATalog?

Returns the subdirectories of the current or specified directory.

Query parameters:

<path_name> String parameter to specify the directory. If the directory is omitted, the command queries the content of the current directory, queried with `MMEM:CDIR` command.

Return values:

<Dcatalog> <file_entry>
 Names of the subdirectories separated by colons. The first two strings are related to the parent directory.

Example: See ["Working with Files and Directories"](#) on page 381.

Usage: Query only

:MMEMory:DCATalog:LENGth? [<path_name>]

Returns the number of subdirectories in the current or specified directory.

Query parameters:

<path_name> String parameter to specify the directory. If the directory is omitted, the command queries the contents of the current directory, to be queried with `MMEM:CDIR` command.

Return values:

<file_entry_count> Number of parent and subdirectories.

Example: See ["Working with Files and Directories"](#) on page 381.

:MMEMory:DELeTe <Delete>

Removes a file from the specified directory.

Setting parameters:

<Delete> <file_name>
String parameter to specify the name and directory of the file to be removed.

Example: See "[Working with Files and Directories](#)" on page 381.

Usage: Event
SCPI confirmed

Manual control: See "[Cut](#)" on page 113

:MMEMory:LOAD:STATe <sav_rcl_state_number>, <file_name>

This command loads the specified file stored under the specified name in an internal memory.

After the file has been loaded, the instrument setting must be activated using an *RCL command.

Setting parameters:

<sav_rcl_state_number> Determines to the specific <number> to be used with the *RCL command, e.g. *RCL 4.

<file_name> String parameter to specify the file name with extension *.savrcltxt.

Example: See "[Storing and Loading Current Settings](#)" on page 381.

Usage: Setting only

Manual control: See "[Recall](#)" on page 111

:MMEMory:MDIRectory <directory_name>

Creates a new subdirectory for mass memory storage in the specified directory. If no directory is specified, a subdirectory is created in the default directory. This command can also be used to create a directory tree.

Setting parameters:

<directory_name> string
String parameter to specify the new directory.

Example: See "[Working with Files and Directories](#)" on page 381.

Usage: Setting only

Manual control: See "[Create New Directory](#)" on page 113

:MMEMory:MOVE <file_source>, <file_destination>

Moves an existing file to a new location or, if no path is specified, renames an existing file.

It is also possible to specify the path using another parameter. The command is:

MMEMory:MOVE

file_source,msus_source[, file_destination, msus_destination]

Setting parameters:

<file_source> String parameter to specify the name of the file to be moved.

<file_destination> String parameters to specify the name of the new file.

Example: See "[Working with Files and Directories](#)" on page 381.

Usage: Setting only
SCPI confirmed

Manual control: See "[Rename](#)" on page 113

:MMEMory:MSIS <Msis>

The command is without effect for the Linux operating system.

Usage: SCPI confirmed

:MMEMory:RDIRECTory <Rdirectory>

Removes an existing directory from the mass memory storage system. If no directory is specified, the subdirectory with the specified name is deleted in the default directory.

Setting parameters:

<Rdirectory> string
String parameter to specify the directory to be deleted.

Example: See "[Working with Files and Directories](#)" on page 381.

Usage: Setting only

:MMEMory:STORE:STATE <savrcl_state_nr>, <file_name>

Stores the current instrument setting in the specified file.

The instrument setting must first be stored in an internal memory with the same number using the common command *SAV.

Setting parameters:

<savrcl_state_nr> Corresponds to the specific <number> defined with the *SAV command, e.g. *SAV 4.

<file_name> String parameter to specify the file name with extension *.savrcltxt.

Example: See "[Storing and Loading Current Settings](#)" on page 381.

Usage: Event

Manual control: See "[Save](#)" on page 110

7.11 OUTPut Subsystem

The OUTPut system contains the commands which set the properties of the RF output connector.

The properties of the LF output connector are set in the [chapter 7.13.10, "SOURce:LFOutput Subsystem"](#), on page 525 system.

:OUTPut<hw>:AFIXed:RANGe:LOWer?	388
:OUTPut<hw>:AFIXed:RANGe:UPPer?	388
:OUTPut<hw>:AMODE	389
:OUTPut<hw>:IMPedance?	389
:OUTPut<hw>:PROTection:CLEar	390
:OUTPut<hw>:PROTection:TRIPped?	390
:OUTPut<hw>[:STATe]	390
:OUTPut<hw>[:STATe]:PON	390

:OUTPut<hw>:AFIXed:RANGe:LOWer?

The command queries the minimum level which can be set without the attenuator being adjusted (Attenuator FIXed).

Return values:

<Lower> float
Default unit: dBm

Example: OUTP:AFIX:RANG:LOW
queries the minimum level for the FIXed setting.

Example: Response: -50
The minimum level is -50 dBm.

Usage: Query only

Manual control: See "[Fixed Range \(PEP\) In](#)" on page 130

:OUTPut<hw>:AFIXed:RANGe:UPPer?

The command queries the maximum level which can be set without the attenuator being adjusted (Attenuator FIXed).

Return values:

<Upper> float
Default unit: dBm

Example: OUTP:AFIX:RANG:UPP
queries the maximum level for the FIXed setting for the RF output.

Example: Response: -27
The maximum level is -27 dBm.

Usage: Query only

Manual control: See "[Fixed Range \(PEP\) In](#)" on page 130

:OUTPut<hw>:AMODE <Amode>

The command switches the mode of the attenuator at the RF output (Attenuator MODE).

Parameters:

<Amode> AUTO | FIXed | NORMal | HPOWer

AUTO

The level settings are made in the area of the electronically switching attenuator as well as in the area of the relay-switched high power bypass. The entire level range is available.

FIXed

The level settings are made without switching the attenuator or the relays. When this operating mode is switched on, the attenuator and the relays are fixed in their current positions and the resulting variation range is defined.

NORMal

The level settings are made only in the area of the electronically switching attenuator. The high level ranges are not available.

HPOWer

The level settings are made only in the area of the high level ranges. Only the high level range is available. The relays are not switched.

*RST: AUTO

Example:

```
POW:AIC ON
activates automatic level control for RF output.
OUTP:AMOD FIX
sets the fixed mode with uninterrupted level for RF output.
```

Manual control: See "[Attenuator Mode](#)" on page 129

:OUTPut<hw>:IMPedance?

The command queries the impedance of the RF outputs. This permits converting the output level between units V and W. The impedances cannot be changed.

Return values:

<Impedance> G50 | G1K | G10K
Default unit: Ohm

Example:

```
OUTP:IMP
queries the impedance of RF output.
Response:            50
the impedance is 50 ohms
```

Usage:

Query only
SCPI confirmed

:OUTPut<hw>:PROTection:CLEar

The command resets the protective circuit after it has been tripped. The state of the output is again determined by `OUTPut:STATe`.

The outputs are protected by a protective circuit which deactivates the output in the case of an externally applied overvoltage. This does not change the value of `OUTPut:STATe`.

Example: `OUTP:PROT:CLE`
resets the protective circuit for RF output.

Usage: Event
SCPI confirmed

Manual control: See "[Overload](#)" on page 131

:OUTPut<hw>:PROTection:TRIPped?

The command queries the state of the protective circuit.

Return values:
<Tripped> 0 | 1 | OFF | ON

Example: `OUTP:PROT:TRIP`
Queries the state of the protective circuit for RF output A.
Response: 0
The protective circuit has not tripped.
Response: 1
The protective circuit has tripped.

Usage: Query only

Manual control: See "[Overload](#)" on page 131

:OUTPut<hw>[:STATe] <State>

This command activates and deactivates the RF output.

Parameters:
<State> 0 | 1 | OFF | ON

Example: `OUTP OFF`
deactivates the RF output.

Usage: SCPI confirmed

Manual control: See "[State RF](#)" on page 114

:OUTPut<hw>[:STATe]:PON <Pon>

This command selects the state which the RF output assumes when the instrument is switched on.

Parameters:

<Pon> OFF | UNCHanged

OFF

The output is deactivated when the instrument is switched on.

UNCHanged

When the instrument is switched on, the output remains in the same state as it was when the instrument was switched off.

Example:

OUTP:PON OFF

RF output A is deactivated when the instrument is switched on.

Manual control:See "[Power-On State - RF Signal](#)" on page 132

7.12 Power Sensor Measurement Subsystems

The power sensor measurement uses several subsystems:

- The `CALCulate` subsystem is used to configure the time gated measurements in power analysis.
- The `DISPlay` subsystem is used to configure the diagram appearance.
- The `INITiate` command switches the local state of the continuous power measurement on and off.
- The `READ` system is used to start and to retrieve the measurement result of the power viewer measurement.
- The `SENSe` subsystem contains the commands for configuring the power viewer and power analysis measurements with power sensors connected to the generator. Up to three sensors can be connected to the signal generator.
- The `TRACe` subsystem is used to configure the traces in power analysis and to retrieve the measurement results.

Power Viewer

The power viewer measurement is started with the `READ` command, this command also retrieves the measurement results.

The sensors are distinguished by means of the suffix under `SENSe`:

- Power sensor connected to the `SENSOR` port = `SENSe[1]`
- First Power sensor connected to the USB interface = `SENSe2`
- Second Power sensor connected to the USB interface = `SENSe3`

Third Power sensor connected to the USB interface = `SENSe4`

Power and Pulse Data Analysis, Gated Measurements (option R&S SMA-K28)

The power analysis measurement commands are subsumed under the `SENSe[:POWER]:SWEp:...` commands. Three measurement modes are available: Frequency, Power and Time.

The power analysis measurement is started with the `SENSe[:POWer]:SWEep:INITiate` command and the measurement result retrieved with the `TRACe[:POWer]:SWEep:...` commands.

The four sensors are distinguished by means of the suffix at the second key word `SENSe`.

The time gate settings are performed using the `CALCulate[:POWer]:SWEep:...` commands.

The measurement diagram and results can be stored in a hardcopy with the `SENSe[:POWer]:SWEep:HCOPY:...` commands.

General parameter and measurement settings are valid for all connected sensors, therefore, no suffix is used in these commands.

7.12.1 CALCulate Subsystem

<code>:CALCulate[:POWer]:SWEep:TIME:GATE<ch>AVERage?</code>	392
<code>:CALCulate[:POWer]:SWEep:TIME:GATE<ch>:FEED</code>	393
<code>:CALCulate[:POWer]:SWEep:TIME:GATE<ch>MAXimum?</code>	393
<code>:CALCulate[:POWer]:SWEep:TIME:GATE<ch>START</code>	393
<code>:CALCulate[:POWer]:SWEep:TIME:GATE<ch>:STATE</code>	394
<code>:CALCulate[:POWer]:SWEep:FREQuency:MATH<ch>:STATE</code>	394
<code>:CALCulate[:POWer]:SWEep:FREQuency:MATH<ch>:SUBTract</code>	394
<code>:CALCulate[:POWer]:SWEep:POWer:MATH<ch>:STATE</code>	395
<code>:CALCulate[:POWer]:SWEep:POWer:MATH<ch>:SUBTract</code>	395
<code>:CALCulate[:POWer]:SWEep:TIME:MATH<ch>:STATE</code>	395
<code>:CALCulate[:POWer]:SWEep:TIME:MATH<ch>:SUBTract</code>	396

`:CALCulate[:POWer]:SWEep:TIME:GATE<ch>AVERage?`

This command queries the average power value of the time gated measurement.

Return values:

<Average>	float
	Range: -1000 to 1000
	Increment: 1E-12
	*RST: 0

Example:

```
SENS:SWE:MODE TIME
activates time mode for power analysis.
CALC:SWE:TIME:GATE:STAT ON
activates time gated measurement.
SENS:SWE:INIT
activates a single power analysis measurement.
CALC:SWE:TIME:GATE2:AVER?
queries the average power in time gate 2 for trace 1 (=default).
```

Usage: Query only

Options: Option R&S SMA-K28

Manual control: See "State - Gate" on page 170

:CALCulate[:POWER]:SWEep:TIME:GATE<ch>:FEED <Feed>

This command selects the trace for time gated measurement. Both gates are assigned to the same trace.

Parameters:

<Feed> TRACe1 | TRACe2 | TRACe3
 *RST: TRACe1

Example: CALC:SWE:TIME:GATE:FEED TRAC2
 assigns the gates to trace 2.

Options: Option R&S SMA-K28

Manual control: See "Trace - Gate" on page 169

:CALCulate[:POWER]:SWEep:TIME:GATE<ch>MAXimum?

This command queries the average power value of the time gated measurement.

Return values:

<Maximum> float
 Range: -1000 to 1000
 Increment: 1E-12
 *RST: 0

Example: SENS:SWE:MODE TIME
 activates time mode for power analysis.
 CALC:SWE:TIME:GATE:STAT ON
 activates time gated measurement.
 SENS:SWE:INIT
 activates a single power analysis measurement.
 CALC:SWE:TIME:GATE2:MAX?
 queries the peak power in time gate 2 for trace 1 (=default).

Usage: Query only

Options: Option R&S SMA-K28

Manual control: See "State - Gate" on page 170

:CALCulate[:POWER]:SWEep:TIME:GATE<ch>START <Start>

This command sets the start time of the selected gate. Insert value and unit.

Parameters:

<Start> float
 Increment: 1E-12
 *RST: Start/Stop: 5/15 (Gate1), 25/35 (Gate2)
 Default unit: μ s

- Example:** `CALC:SWE:TIME:GATE2:STAR 20us`
sets a start time of 20 us for gate 2.
- Example:** `CALC:SWE:TIME:GATE2:STOP 30us`
sets a stop time of 30us for gate 2.
- Options:** Option R&S SMA-K28
- Manual control:** See "[Start / Stop - Gate](#)" on page 170

:CALCulate[:POWER]:SWEep:TIME:GATE<ch>:STATe <State>

This command activates gate settings for the selected trace. The measurement is started with command `SENS:POW:INIT`. Both gates are active at one time.

Parameters:

<State> 0 | 1 | OFF | ON
*RST: OFF

Example: `CALC:SWE:TIME:GATE:STAT ON`
'enables time gated measurement.

- Options:** Option R&S SMA-K28
- Manual control:** See "[State - Gate](#)" on page 170

:CALCulate[:POWER]:SWEep:FREQuency:MATH<ch>:STATe <State>

This command activates / deactivates the trace mathematics mode for "Frequency" measurement. This feature enables to calculate the difference between the measurement values of two traces. Additionally, for further calculation a math result can also be assigned to a trace.

Parameters:

<State> 0 | 1 | OFF | ON
*RST: 0

Example: `CALC:POW:SWE:FREQ:MATH2:STATe`

Example: switches on math mode in trace 2.

- Options:** R&S SMA-K28
- Manual control:** See "[Mathematics - Trace Power Analysis](#)" on page 160

:CALCulate[:POWER]:SWEep:FREQuency:MATH<ch>:SUBTract <Subtract>

This command executes the subtraction of the operands 1 and 2 and assigns the result to the selected trace in "Frequency" measurement mode.

Parameters:

<Subtract> T1T1 | T1T2 | T1T3 | T1T4 | T1REf | T2T1 | T2T2 | T2T3 | T2T4 |
T2REf | T3T1 | T3T2 | T3T3 | T3T4 | T3REf | T4T1 | T4T2 | T4T3 |
T4T4 | T4REf

- Example:** `CALC:POW:SWE:FREQ:MATH4:SUBT T2REF`
- Example:** Subtracts the **Reference** and **Trace 2**, and assigns the result to **Trace 4**. The resulting curve is shown in the diagram.
- Options:** R&S SMA-K28
- Manual control:** See "[Mathematics - Trace Power Analysis](#)" on page 160

:CALCulate[:POWER]:SWEep:POWER:MATH<ch>:STATe <State>

This command activates / deactivates the trace mathematics mode for "Power" measurement. This feature enables to calculate the difference between the measurement values of two traces. Additionally, for further calculation a math result can also be assigned to a trace.

Parameters:

<State> 0 | 1 | OFF | ON
*RST: 0

Example: `CALC:POW:SWE:POW:MATH2:STATe`

Example: switches on math mode in trace 2.

Options: R&S SMA-K28

Manual control: See "[Mathematics - Trace Power Analysis](#)" on page 160

:CALCulate[:POWER]:SWEep:POWER:MATH<ch>:SUBTRACT <Subtract>

This command executes the subtraction of the operands 1 and 2 and assigns the result to the selected trace in "Power" measurement mode.

Parameters:

<Subtract> T1T1 | T1T2 | T1T3 | T1T4 | T1REF | T2T1 | T2T2 | T2T3 | T2T4 | T2REF | T3T1 | T3T2 | T3T3 | T3T4 | T3REF | T4T1 | T4T2 | T4T3 | T4T4 | T4REF

Example: `CALC:POW:SWE:POW:MATH4:SUBT T2REF`

Example: Subtracts the **Reference** and **Trace 2**, and assigns the result to **Trace 4**. The resulting curve is shown in the diagram.

Options: R&S SMA-K28

Manual control: See "[Mathematics - Trace Power Analysis](#)" on page 160

:CALCulate[:POWER]:SWEep:TIME:MATH<ch>:STATe <State>

This command activates / deactivates the trace mathematics mode for "Time" measurement. This feature enables to calculate the difference between the measurement values of two traces. Additionally, for further calculation a math result can also be assigned to a trace.

Parameters:

<State> 0 | 1 | OFF | ON
 *RST: 0

Example:

CALC:POW:SWE:TIME:MATH1:STATe

Example:

switches on math mode.

Options:

R&S SMA-K28

Manual control:

See ["Mathematics - Trace Power Analysis"](#) on page 160

:CALCulate[:POWER]:SWEep:TIME:MATH<ch>:SUBTract <Subtract>

This command executes the subtraction of the operands 1 and 2 and assigns the result to the selected trace in "Time" measurement mode.

Parameters:

<Subtract> T1T1 | T1T2 | T1T3 | T1T4 | T1REf | T2T1 | T2T2 | T2T3 | T2T4 |
 T2REf | T3T1 | T3T2 | T3T3 | T3T4 | T3REf | T4T1 | T4T2 | T4T3 |
 T4T4 | T4REf

Example:

CALC:POW:SWE:TIME:MATH4:SUBT T2REF

Example:

Subtracts the **Reference** and **Trace 2**, and assigns the result to **Trace 4**. The resulting curve is shown in the diagram.

Options:

R&S SMA-K28

Manual control:

See ["Mathematics - Trace Power Analysis"](#) on page 160

7.12.2 DISPlay Subsystem

[:DISPlay\[:WINDow\]\[:POWER\]:SWEep:BACKground:COLor](#).....396

[:DISPlay\[:WINDow\]\[:POWER\]:SWEep:GRID:STATe](#).....396

:DISPlay[:WINDow][:POWER]:SWEep:BACKground:COLor <Color>

This command defines the background color of the measurement diagram. The background color is also effective for the hardcopy of the diagram.

Parameters:

<Color> BLACK | WHITe
 *RST: BLACK

Example:

DISP:SWE:BACK:COL WHIT
 the measurement is indicated with a white background.

Manual control:

See ["Bg Color - Power Analysis"](#) on page 166

:DISPlay[:WINDow][:POWER]:SWEep:GRID:STATe <State>

This command activates/deactivates the indication of a grid in the diagram area..

Parameters:

<State> 0 | 1 | OFF | ON
 *RST: 1

Example:

DISP:SWE:GRID:STAT OFF
 deactivates the indication of a grid in the diagram area.

Manual control:

See "Grid - Power Analysis" on page 166

7.12.3 INITiate Command

:INITiate<ch>[:POWER]:CONTinuous <Continuous>

The command switches the local state of the continuous power measurement by the R&S NRP-Zxx power sensors on and off. Switching the local state off enhances the measurement performance during remote control

The remote measurement is triggered by the READ query (command [:READ<ch>\[:POWER\]?](#) on page 397) which also provides the measurement results. The local state is not influenced by this command, measurements results can be retrieved with local state on or off.

Parameters:

<Continuous> 0 | 1 | OFF | ON
 *RST: OFF

Example:

INIT:CONT ON
 switches local state of continuous power measurement on.

Manual control:

See "State - Power Sensors" on page 147

7.12.4 READ Subsystem

:READ<ch>[:POWER]?

The command triggers the measurement with power sensors and provides the power measurement result of the selected power sensor. The value is provided with the unit set with command `SENSe:UNIT[:POWER]`.

For certain power sensors, e.g. R&S NRP-Z81, two values are returned, first the value for the average level and - separated by a comma - the peak level

Note: The local state is not influenced by this command, measurements results can be retrieved with local state on or off. For long measurement times it is recommended to use a SRQ (MAV bit) for command synchronization.

Suffix:

<ch> 1..3

Return values:

<Power> string

Example:	<p>SENS:UNIT DBM selects unit dBm for presentation of measurement result.</p> <p>READ1? queries the measurement result of the sensor connected to the SENSOR interface.</p> <p>Response: -45.6246576745440230 -45.6 dBm were measured at the given frequency. or e.g. for R&S NRP-Z81</p> <p>Response: -55.62403263352178, -22.419472478812476 -55,6 dbm is the measured average level, -22.4 dBm is the measured peak level at the given frequency</p>
Usage:	Query only
Manual control:	See " Level (Peak) - Power Sensors " on page 147

7.12.5 SENSE Subsystem

SENSe<ch>[:POWer]:CORRection:SPDeVice:STATe.....	400
SENSe<ch>[:POWer]:DISPlay:PERManent:PRIOrity.....	401
SENSe<ch>[:POWer]:DISPlay:PERManent:STATe.....	401
SENSe<ch>[:POWer]:FILTer:LENGTh:AUTO?.....	401
SENSe<ch>[:POWer]:FILTer:LENGTh[:USER].....	402
SENSe<ch>[:POWer]:FILTer:NSRatio.....	402
SENSe<ch>[:POWer]:FILTer:NSRatio:MTIME.....	402
SENSe<ch>[:POWer]:FILTer:SONCe.....	403
SENSe<ch>[:POWer]:FILTer:TYPE.....	403
SENSe<ch>[:POWer]:FREQuency.....	404
SENSe<ch>[:POWer]:OFFSet.....	404
SENSe<ch>[:POWer]:OFFSet:STATe.....	405
SENSe<ch>[:POWer]:SNUMber?.....	405
SENSe<ch>[:POWer]:SOURce.....	405
SENSe<ch>[:POWer]:STATus[:DEVice]?.....	406
SENSe<ch>[:POWer]:SVERsion?.....	406
SENSe[:POWer]:SWEep:ABORT.....	406
:SENSe[:POWer]:SWEep:FREQuency:REFerence:DATA:COpy.....	407
:SENSe[:POWer]:SWEep:FREQuency:REFerence:DATA:POINts?.....	407
:SENSe[:POWer]:SWEep:FREQuency:REFerence:DATA:XVALues.....	407
:SENSe[:POWer]:SWEep:FREQuency:REFerence:DATA:YVALues.....	407
:SENSe[:POWer]:SWEep:FREQuency:RMODE.....	408
:SENSe<ch>[:POWer]:SWEep:FREQuency[:SENSor]:OFFSet.....	408
:SENSe<ch>[:POWer]:SWEep:FREQuency[:SENSor]:OFFSet:STATe.....	408
:SENSe<ch>[:POWer]:SWEep:FREQuency[:SENSor]:SRANge[:STATe].....	409
:SENSe<ch>[:POWer]:SWEep:FREQuency[:SENSor]:SRANge:STARt.....	409
:SENSe<ch>[:POWer]:SWEep:FREQuency[:SENSor]:SRANge:STOP.....	409
:SENSe[:POWer]:SWEep:FREQuency:SPACing[:MODE].....	410
:SENSe[:POWer]:SWEep:FREQuency:STARt.....	410
:SENSe[:POWer]:SWEep:FREQuency:STEPs.....	410
:SENSe[:POWer]:SWEep:FREQuency:STOP.....	411

:SENSe[:POWer]:SWEep:FREQuency:TIMing[:MODE].....	411
:SENSe[:POWer]:SWEep:FREQuency:YSCale:AUTO.....	411
:SENSe[:POWer]:SWEep:FREQuency:YSCale:AUTO:RESet.....	412
:SENSe[:POWer]:SWEep:FREQuency:YSCale:MAXimum.....	412
:SENSe[:POWer]:SWEep:FREQuency:YSCale:MINimum.....	413
SENSe[:POWer]:SWEep:HCOPY:DATA?.....	413
SENSe[:POWer]:SWEep:HCOPY:DEVIce.....	414
SENSe[:POWer]:SWEep:HCOPY:DEVIce:LANGUage.....	415
SENSe[:POWer]:SWEep:HCOPY:DEVIce:LANGUage:CSV:DPOint.....	415
SENSe[:POWer]:SWEep:HCOPY:DEVIce:LANGUage:CSV:HEADer.....	415
SENSe[:POWer]:SWEep:HCOPY:DEVIce:LANGUage:CSV:ORientation.....	416
SENSe[:POWer]:SWEep:HCOPY:DEVIce:LANGUage:CSV[:COLumn]:SEParator.....	416
SENSe[:POWer]:SWEep:HCOPY:DEVIce:SIZE.....	416
SENSe[:POWer]:SWEep:HCOPY[:EXECute].....	417
SENSe[:POWer]:SWEep:HCOPY:FILE[:NAME].....	417
SENSe[:POWer]:SWEep:HCOPY:FILE[:NAME]:AUTO:DIRectory.....	418
SENSe[:POWer]:SWEep:HCOPY:FILE[:NAME]:AUTO:DIRectory:CLEar.....	418
SENSe[:POWer]:SWEep:HCOPY:FILE[:NAME]:AUTO:FILE?.....	418
SENSe[:POWer]:SWEep:HCOPY:FILE[:NAME]:AUTO[:FILE]:DAY?.....	419
SENSe[:POWer]:SWEep:HCOPY:FILE[:NAME]:AUTO[:FILE]:DAY:STATe.....	419
SENSe[:POWer]:SWEep:HCOPY:FILE[:NAME]:AUTO[:FILE]:MONTH?.....	419
SENSe[:POWer]:SWEep:HCOPY:FILE[:NAME]:AUTO[:FILE]:MONTH:STATe.....	420
SENSe[:POWer]:SWEep:HCOPY:FILE[:NAME]:AUTO[:FILE]:NUMBer?.....	420
SENSe[:POWer]:SWEep:HCOPY:FILE[:NAME]:AUTO[:FILE]:PREFix.....	420
SENSe[:POWer]:SWEep:HCOPY:FILE[:NAME]:AUTO[:FILE]:PREFix:STATe.....	420
SENSe[:POWer]:SWEep:HCOPY:FILE[:NAME]:AUTO[:FILE]:YEAR?.....	421
SENSe[:POWer]:SWEep:HCOPY:FILE[:NAME]:AUTO[:FILE]:YEAR:STATe.....	421
SENSe[:POWer]:SWEep:HCOPY:FILE[:NAME]:AUTO:STATe.....	421
:SENSe[:POWer]:SWEep:INITiate.....	422
SENSe[:POWer]:SWEep:MODE.....	422
:SENSe[:POWer]:SWEep:POWer:REFerence:DATA:COpy.....	422
:SENSe[:POWer]:SWEep:POWer:REFerence:DATA:POINts?.....	422
:SENSe[:POWer]:SWEep:POWer:REFerence:DATA:XVALues.....	422
:SENSe[:POWer]:SWEep:POWer:REFerence:DATA:YVALues.....	423
SENSe[:POWer]:SWEep:POWer:RMODE.....	423
:SENSe<ch>[:POWer]:SWEep:POWer[:SENSor]:OFFSet.....	423
:SENSe<ch>[:POWer]:SWEep:POWer[:SENSor]:OFFSet:STATe.....	424
SENSe<ch>[:POWer]:SWEep:POWer[:SENSor]:SFRequency.....	424
SENSe<ch>[:POWer]:SWEep:POWer[:SENSor]:SFRequency:STATe.....	424
:SENSe<ch>[:POWer]:SWEep:TIME[:SENSor]:OFFSet.....	424
:SENSe<ch>[:POWer]:SWEep:TIME[:SENSor]:OFFSet:STATe.....	425
:SENSe<ch>[:POWer]:SWEep:TIME[:SENSor]:PULSe:STATe.....	425
SENSe<ch>[:POWer]:SWEep:TIME[:SENSor]:PULSe:THReShold:BASE.....	425
:SENSe<ch>[:POWer]:SWEep:TIME[:SENSor]:PULSe:THReShold:POWer:HREFerence.....	426
:SENSe<ch>[:POWer]:SWEep:TIME[:SENSor]:PULSe:THReShold:POWer:REFerence.....	426
:SENSe<ch>[:POWer]:SWEep:TIME[:SENSor]:PULSe:THReShold:POWer:LREFerence.....	427
SENSe[:POWer]:SWEep:POWer:SPACing[:MODE].....	427
SENSe[:POWer]:SWEep:POWer:START.....	427
SENSe[:POWer]:SWEep:POWer:STEPS.....	428
SENSe[:POWer]:SWEep:POWer:STOP.....	428

SENSe[:POWer]:SWEep:POWer:TIMing[:MODE].....	428
SENSe[:POWer]:SWEep:POWer:YSCale:AUTO.....	428
SENSe[:POWer]:SWEep:POWer:YSCale:AUTO:RESet.....	429
SENSe[:POWer]:SWEep:POWer:YSCale:MAXimum.....	429
SENSe[:POWer]:SWEep:POWer:YSCale:MINimum.....	430
SENSe[:POWer]:SWEep:RMODE.....	430
SENSe[:POWer]:SWEep:TIME:RMODE.....	430
:SENSe[:POWer]:SWEep:TIME:AVERage[:COUNT].....	431
:SENSe[:POWer]:SWEep:TIME:REFErence:DATA:COpy.....	431
:SENSe[:POWer]:SWEep:TIME:REFErence:DATA:POINts?.....	431
:SENSe[:POWer]:SWEep:TIME:REFErence:DATA:XVALues.....	431
:SENSe[:POWer]:SWEep:TIME:REFErence:DATA:YVALues.....	432
SENSe<ch>[:POWer]:SWEep:TIME[:SENSor]:SFRequency.....	432
SENSe<ch>[:POWer]:SWEep:TIME[:SENSor]:SFRequency:STATe.....	432
SENSe<ch>[:POWer]:SWEep:TIME[:SENSor]:TRIGger:AUTO.....	432
SENSe<ch>[:POWer]:SWEep:TIME[:SENSor]:TRIGger:DTIME.....	433
SENSe<ch>[:POWer]:SWEep:TIME[:SENSor]:TRIGger:HYSTEResis.....	433
SENSe<ch>[:POWer]:SWEep:TIME[:SENSor]:TRIGger:LEVel.....	433
:SENSe<ch>[:POWer]:SWEep:TIME[:SENSor]:TRIGger:SLOPe.....	434
SENSe<ch>[:POWer]:SWEep:TIME[:SENSor]:TRIGger:SOURce.....	434
SENSe[:POWer]:SWEep:TIME:SPACing[:MODE]?.....	434
SENSe[:POWer]:SWEep:TIME:STARt.....	434
SENSe[:POWer]:SWEep:TIME:STEPs.....	435
SENSe[:POWer]:SWEep:TIME:STOP.....	435
:SENSe[:POWer]:SWEep:TIME:TEVents.....	435
SENSe[:POWer]:SWEep:TIME:YSCale:AUTO.....	436
SENSe[:POWer]:SWEep:TIME:YSCale:AUTO:RESet.....	436
SENSe[:POWer]:SWEep:TIME:YSCale:MAXimum.....	437
SENSe[:POWer]:SWEep:TIME:YSCale:MINimum.....	437
SENSe<ch>[:POWer]:TYPE?.....	437
SENSe<ch>[:POWer]:ZERO.....	438
SENSe<ch>:UNIT[:POWer].....	438

SENSe<ch>[:POWer]:CORRection:SPDevice:STATe <State>

The command activates the use of the s-parameters correction data of the selected power sensor.

Note: For power sensor with attenuator this command is automatically set to ON.

Parameters:

<State> 0 | 1 | OFF | ON
 *RST: OFF

Example:

SENS:POW:CORR:SPD:STAT ON
 activates the use of the s-parameters correction data of power sensor 1.

Manual control: See "Use SParameter - Power Sensors" on page 137

SENSe<ch>[:POWER]:DISPlay:PERManent:PRiority <Priority>

The command selects which power measurement result (average or peak power) is indicated when permanent display is active.

Parameters:

<Priority> AVERAge | PEAK
*RST: AVERAge

Example:

SENS1:DISP:PERM:STAT ON
the permanent viewer is switched on.
SENS1:DISP:PERM:PRI AVER
the measured average power is indicated.

Manual control: See "[Display Priority - Power Sensors](#)" on page 148

SENSe<ch>[:POWER]:DISPlay:PERManent:STATe <State>

The command switches on and off the permanent indication of the power measurement result in the upper right corner of the block diagram. For each sensor, the type of sensor, the connector, the measurement source and - if set - the offset is indicated.

Parameters:

<State> 0 | 1 | OFF | ON
*RST: OFF

Example:

SENS1:POW:DISP:PERM:STAT ON
the permanent viewer is switched on.

Manual control: See "[Permanent Display State - Power Sensors](#)" on page 148

SENSe<ch>[:POWER]:FILTer:LENGth:AUTO?

The command queries the current filter length for auto filter mode
(:SENSe<[1]...3>:POWER:FILTer:TYPE AUTO)

Return values:

<Auto> float

Example:

SENS1:FILT:TYPE AUTO
selects auto filter mode for the power sensor connected to the
SENSOR connector.
SENS1:FILT:LENG:AUTO?
queries the automatically set filter length.
Response: 1024

Usage: Query only

Manual control: See "[Filter Length - Power Sensors](#)" on page 149

SENSe<ch>[:POWer]:FILTer:LENGth[:USER] <User>

The command selects the filter length for user filter mode (`SENSe:POWer:FILTer:TYPE USER`). As the filter length works as a multiplier for the time window, a constant filter length results in a constant measurement time. Values 1 and 2^n are settable.

The time window is fixed to 20 ms.

Parameters:

<User> float
 Range: 1 to 65536
 *RST: 1

Example:

`SENS:FILT:TYPE USER`
 selects user filter mode.
`SENS:FILT:LENG 16`
 sets a filter length of 16. The resulting measurement time is 640 ms ($2 \times 16 \times 20$ ms).

Manual control: See ["Filter Length - Power Sensors"](#) on page 149

SENSe<ch>[:POWer]:FILTer:NSRatio <Nratio>

The command defines the noise content for fixed noise filter mode (`:SENSe<[1]...3>:POWer:FILTer:TYPE NSRatio`). This value determines the proportion of intrinsic noise in the measured result.

Parameters:

<Nratio> float
 Range: 0.0001 to 1.0
 *RST: 0.01

Example:

`SENS1:FILT:TYPE NSR`
 selects fixed noise filter mode for the power sensor connected to the SENSOR connector.
`SENS1:FILT:NSR 0.2`
 sets a noise content of 0.2.

Manual control: See ["Filter Length - Power Sensors"](#) on page 149

SENSe<ch>[:POWer]:FILTer:NSRatio:MTIME <Mtime>

The command defines the timeout for fixed noise filter mode (`:SENSe<[1]...3>:POWer:FILTer:TYPE NSRatio`). This value ensures limited settling times.

Parameters:

<Mtime> float
 Range: 1.0 to 999.99
 *RST: 4
 Default unit: s

Example: `SENS1:FILT:TYPE NSR`
 selects fixed noise filter mode for the power sensor connected to the SENSOR connector.
`SENS1:FILT:NSR .2`
 sets a noise content of 0.2.
`SENS1:FILT:NSR:MTIM 5`
 limits the settling time to 5 seconds

Manual control: See "[Filter Length - Power Sensors](#)" on page 149

SENSe<ch>[:POWER]:FILTer:SONCe

The command activates the search for the optimum filter length for the current measurement conditions. The found filter length can be retrieved with command `:SENSe:POWer:FILTer:LENGth:USER?`. This command is only available for user filter mode (`:SENSe:POWer:FILTer:TYPE USER`).

Example: `SENS:FILT:TYPE USER`
 selects user filter mode.
`SENS:FILT:SONC`
 activates the search for the optimum filter length.
`SENS:FILT:LENG?`
 returns the found optimum filter length.
 Response: 128

Usage: Event

Manual control: See "[Auto Once](#)" on page 149

SENSe<ch>[:POWER]:FILTer:TYPE <Type>

The command selects the filter mode. The filter length is the multiplier for the time window and thus directly influences the measurement time.

Parameters:

<Type>

AUTO | USER | NSRatio

AUTO

The filter length is automatically selected depending on the measured value. For high values, a short filter length is selected and for low values a long filter length is selected.

USER

The filter length is set manually. As the filter length works as a multiplier for the measurement time, this results in a constant measurement time.

NSRatio

The filter length (averaging factor) is selected so that the sensor's intrinsic noise (2 standard deviations) does not exceed the specified noise content. The desired noise content is entered with command `SENSe:FILTer:NSRatio`.

To avoid very long settling times when the power is low, the averaging factor can be limited with the Timeout parameter (command `SENSe:FILTer:NSRatio:MTIME`).

*RST: AUTO

Example:

```
SENS:FILT:TYPE AUTO
selects automatic filter selection.
```

Manual control:

See "[Filter Length - Power Sensors](#)" on page 149

SENSe<ch>[:POWER]:FREQuency <Frequency>

The command sets the RF frequency of the source if the user source is selected (`SENSe[:POWER]:SOURce USER`).

Parameters:

<Frequency>

float

*RST: 1 GHz

Example:

```
SENS:SOUR USER
selects user-defined source.
SENS:FREQ 2.44 GHz
enters the RF frequency of the source which is 2.44 GHz.
```

Manual control:

See "[Frequency - Power Sensors](#)" on page 149

SENSe<ch>[:POWER]:OFFSet <Offset>

The command enters a level offset which is added to the measured level value after activation with command `SENSe[:POWER]:OFFSet:STATE ON`. This allows e.g. an attenuator in the signal path to be taken into account.

Parameters:

<Offset> float
 Range: -100.0 to 100.0
 *RST: 0
 Default unit: dB

Example:

SENS:POW:OFFS 10.0
 sets a level offset of 10 dB

Manual control:

See "[Level Offset - Power Sensors](#)" on page 149

SENSe<ch>[:POWer]:OFFSet:STATe <State>

The command activates the addition of the level offset to the measured value. The level offset value is set with command `SENSe[:POWer]:OFFSet`.

Parameters:

<State> 0 | 1 | OFF | ON
 *RST: OFF

Example:

SENS1:POW:OFFS 0.4dB
 sets a level offset of 0.4 dB
 SENS1:POW:OFFS:STAT ON
 a level offset of 0.4 dB is added to the measured value.

Manual control:

See "[Level Offset - Power Sensors](#)" on page 149

SENSe<ch>[:POWer]:SNUMber?

The command queries the serial number of the sensor.

Return values:

<Snumber> string

Example:

SENS:SNUM?
 queries the serial number.

Usage:

Query only

Manual control:

See "[Current Sensors](#)" on page 89

SENSe<ch>[:POWer]:SOURce <Source>

The command selects the signal source for the measurement.

Parameters:

<Source> A | B | USER
 *RST: A

Example: `SENS:SOUR A`
 selects the RF signal as measurement source. The RF frequency is used as the measurement frequency of the sensor and the corresponding correction factor is used. The level setting of the instrument serves as reference level of the measurement.

Manual control: See "[Source - Power Sensors](#)" on page 149

SENSe<ch>[:POWER]:STATus[:DEVice]?

The command queries if a sensor is connected to the signal generator.

The sensor is selected by suffix in the keyword SENSE or READ of the command header. Suffix 1 denotes the sensor connected to the SENSOR connector, suffix 2 the sensor connected first to one of the USB interfaces and suffix 3 the sensor connected second to one of the USB interfaces.

Return values:

<DEVice> 0 | 1 | OFF | ON

Example: `SENS:STAT?`
 queries if a sensor is connected to the instrument.
 Response: 1
 a sensor is connected to the POWER SENSOR interface.

Usage: Query only

Manual control: See "[Sensor - Power Viewer](#)" on page 146

SENSe<ch>[:POWER]:SVERsion?

The command queries the software version of the connected R&S NRP power sensor.

Return values:

<Sversion> string

Example: `SENS:POW:SVER?`
 queries the software version of the R&S NRP power sensor.

Usage: Query only

Manual control: See "[Current Sensors](#)" on page 89

SENSe[:POWER]:SWEep:ABORt <Abort>

This command aborts the power analysis with NRP power sensors.

Setting parameters:

<Abort>

Example: `SENS:SWE:ABOR;*OPC?`
 aborts the current power measurement.

Usage: Setting only

:SENSe[:POWer]:SWEep:FREQUency:REFerence:DATA:COpy

This command generates a reference curve for "Frequency" measurement.

Example: `SENS:POW:SWE:FREQ:REF:DATA:COpy`

Example: generates a reference curve in frequency mode.

Usage: Event

Manual control: See ["Define Reference - Trace Power Analysis"](#) on page 159

:SENSe[:POWer]:SWEep:FREQUency:REFerence:DATA:POINts?

This command reads the number of points from the reference curve in "Frequency" measurement.

Return values:

<Points> integer
 Range: 10 to 1000
 Increment: 1

Example: `SENS:POW:SWE:FREQ:REF:DATA:POIN?`

Example: queries the number of points from the reference curve in frequency mode.

Usage: Query only

:SENSe[:POWer]:SWEep:FREQUency:REFerence:DATA:XVALues <XValues>

This command sets or queries the x values of the two reference points, i.e. "Frequency X (Point A)" and "Frequency X (Point B)" in "Frequency" measurement.

Parameters:

<XValues> string

Example: `SENSe:POW:SWE:FREQ:REF:DATA:XVAL 100MHZ,22GHZ`

Example: sets the x value of reference "Point A" to 10 MHz, and the value of "Point B" to 10 GHz.

Manual control: See ["Define Reference - Trace Power Analysis"](#) on page 159

:SENSe[:POWer]:SWEep:FREQUency:REFerence:DATA:YVALues <YValues>

This command sets or queries the y values of the two reference points, i.e. "Pow Y (Point A)" and "Power Y (Point B)" in "Frequency" measurement.

Parameters:

<YValues> string

Example: `SENSe:POW:SWE:FREQ:REF:DATA:YVAL -10,25`

Example: sets the y value of reference "Point A" to -10 dBm, and the value of "Point B" to -25 dBm.

Manual control: See ["Define Reference - Trace Power Analysis"](#) on page 159

:SENSe[:POWer]:SWEep:FREQuency:RMODe <RMode>

This command selects single or continuous mode for measurement mode frequency in power analysis.

Parameters:

<RMode> SINGle | CONTInuous
*RST: CONTInuous

Example: SENS:SWE:FREQ:RMOD SING
selects single measurement

Manual control: See ["Execution - Power Analysis"](#) on page 164

:SENSe<ch>[:POWer]:SWEep:FREQuency[:SENSor]:OFFSet <Offset>

Defines the level offset at the sensor input in dB. Activate the offset with the command [:SENSe<ch>\[:POWer\]:SWEep:FREQuency\[:SENSor\]:OFFSet:STATe](#).

Parameters:

<Offset> float
Range: -100 to 100
Increment: 0.01
*RST: 0

Example: SENS2:SWE:FREQ:OFFS -3dB
defines a level offset of -3 dB.
SENS2:SWE:FREQ:OFFS:STAT ON
activates the specified level offset.

Options: Option R&S SMA-K28

Manual control: See ["Level Offset - Power Analysis"](#) on page 172

:SENSe<ch>[:POWer]:SWEep:FREQuency[:SENSor]:OFFSet:STATe <State>

Activates a level offset at the sensor input. Define the appropriate value with the command [:SENSe<ch>\[:POWer\]:SWEep:FREQuency\[:SENSor\]:OFFSet](#).

Parameters:

<State> 0 | 1 | OFF | ON
*RST: 0

Example: SENS2:SWE:FREQ:OFFS:STAT ON
activates the specified level offset.

Options: Option R&S SMA-K28

Manual control: See ["Level Offset State- Power Analysis"](#) on page 172

:SENSe<ch>[:POWer]:SWEep:FREQUency[:SENSor]:SRANge[:STATe] <State>

This command activates the use of a frequency range for the power measurement that is different to the set signal generator frequency range. The separate frequency range is entered with commands `SENS : SWE : FREQ : SENS : STAR` and `SENS : SWE : FREQ : SENS : STOp`.

Parameters:

<State> 0 | 1 | OFF | ON
 *RST: 1 MHz

Example:

`SENS2 : SWE : FREQ : SENS : SRAN ON`
 activates use of a separate frequency range for frequency versus power measurement for sensor 2.
`SENS2 : SWE : FREQ : SENS : STAR 2.0GHZ`
 sets a sweep start at 2 GHz irrespective of the current signal generator frequency settings.
`SENS2 : SWE : FREQ : SENS : STOP 2.9GHZ`
 sets a sweep stop at 2.9 GHz irrespective of the current signal generator frequency settings.

Manual control: See "[Use Separate Frequency- Power Analysis](#)" on page 172

:SENSe<ch>[:POWer]:SWEep:FREQUency[:SENSor]:SRANge:START <Start>

This command enters the start frequency for the frequency power analysis with separate frequencies.

Parameters:

<Start> integer
 Range: 0 to 1E12
 Increment: 1
 *RST: 1 MHz

Example:

`SENS2 : SWE : FREQ : SENS : SRAN : STAT ON`
 activates use of a separate frequency range for frequency versus power measurement for sensor 2.
`SENS2 : SWE : FREQ : SENS : STAR 2.0GHZ`
 sets a sweep start at 2 GHz irrespective of the current signal generator frequency settings.

Manual control: See "[Min Frequency - Power Analysis](#)" on page 173

:SENSe<ch>[:POWer]:SWEep:FREQUency[:SENSor]:SRANge:STOP <Stop>

This command enters the stop frequency for the frequency power analysis with separate frequencies.

Parameters:

<Stop> integer
 Range: 0 to 1E12
 Increment: 1
 *RST: 22 GHz

Example:

SENS:SWE:FREQ:SENS2:SRAN:STAT ON
 activates use of a separate frequency range for frequency versus power measurement.
 SENS:SWE:FREQ:SENS2:STAR 2.0GHZ
 sets a sweep start at 2 GHz irrespective of the current signal generator frequency settings.
 SENS:SWE:FREQ:SENS2:STOP 2.9GHZ
 sets a sweep stop at 2.9 GHz irrespective of the current signal generator frequency settings.

Manual control: See "[Max Frequency - Power Analysis](#)" on page 173

:SENSe[:POWer]:SWEep:FREQUency:SPACing[:MODE] <Mode>

This command selects the spacing for the frequency power analysis.

Parameters:

<Mode> LINear | LOGarithmic
 *RST: LINear

Example:

SENS:SWE:FREQ:SPAC:MODE LIN
 sets linear spacing of the sweep

Manual control: See "[Spacing - Power Analysis](#)" on page 163

:SENSe[:POWer]:SWEep:FREQUency:STARt <Start>

This command enters the start frequency for the frequency mode.

Parameters:

<Start> float
 Range: 0 to 1E12
 *RST: 1.0 MHz

Example:

SENS:SWE:FREQ:STAR 2.0GHZ
 'sets a sweep start at 2 GHz.

Manual control: See "[Min - Power Analysis](#)" on page 162

:SENSe[:POWer]:SWEep:FREQUency:STEPs <Steps>

This command enters the number of measurement steps for the frequency mode.

Parameters:

<Steps> integer
 Range: 10 to 1000
 *RST: 200

Example:

SENS:SWE:FREQ:STEP 500
 sets 500 steps

Manual control:

See "[Steps - Power Analysis](#)" on page 163

:SENSe[:POWer]:SWEep:FREQuency:STOP <Stop>

This command enters the stop frequency for the frequency mode.

Parameters:

<Stop> float
 Range: 0 to 1E12
 *RST: 22.0 GHz

Example:

SENS:SWE:FREQ:STOP 20.0GHZ
 sets the sweep stop to 20 GHz

Manual control:

See "[Max - Power Analysis](#)" on page 162

:SENSe[:POWer]:SWEep:FREQuency:TIMing[:MODE] <Mode>

Selects the mode in terms of speed and precision of the response of a measurement.

Parameters:

<Mode> FAST | NORMal | HPRecision

FAST

Selection FAST leads to a fast measurement with a short integration time for each measurement step.

NORMal

NORMal leads to a longer but more precise measurement due to a higher integration time for each step.

*RST: NORMal

Example:

SENS:SWE:FREQ:TIM:MODE FAST
 the fast measurement mode is selected.

Manual control:

See "[Timing - Power Analysis](#)" on page 163

:SENSe[:POWer]:SWEep:FREQuency:YSCale:AUTO <Auto>

This command activates/deactivates autoscaling of the Y axis of the diagram.

Parameters:

<Auto>

OFF | CEXPanding | FEXPanding | CFLoating | FFLoating

OFF

Auto scaling is deactivated. If switching from activated to deactivated Auto scaling, the scaling is maintained.

CEXPanding | FEXPanding

Auto scale is activated. The scaling of the Y-axis is selected in such a way, that the trace is always visible. To this end, the range is expanded if the minimum or maximum values of the trace move outside the current scale. The step width is 5 dB for selection course and variable in the range of 0.2 db to 5 dB for selection fine.

CFLoating | FFLoating

Auto scale is activated. The scaling of the Y-axis is selected in such a way, that the trace is always visible. To this end, the range is either expanded if the minimum or maximum values of the trace move outside the current scale or scaled down if the trace fits into a reduced scale. The step width is 5 dB for selection course and variable in the range of 0.2 db to 5 dB for selection fine.

*RST: CEXPanding

Example:

```
SENS:SWE:FREQ:YSC:AUTO OFF
deactivates auto scale
```

Manual control:See ["Auto Scale - Power Analysis"](#) on page 165**:SENSe[:POWer]:SWEep:FREQuency:YSCale:AUTO:RESet**

This command resets the Y scale to suitable values after the use of auto scaling in the expanding mode. For this mode, the scale might get expanded because of temporarily high power values. The reset function resets the diagram in such a way that it matches smaller power values again.

Example:

```
SENS:SWE:FREQ:YSC:AUTO:RES
resets auto scale
```

Usage:

Event

Manual control:See ["Reset Auto Scale - Power Analysis"](#) on page 166**:SENSe[:POWer]:SWEep:FREQuency:YSCale:MAXimum <Maximum>**

This command enters the maximum value for the y axis of the measurement diagram.

Parameters:

<Maximum>

float

Range: -200 to 100

Increment: 0.01

*RST: 40.0 dBm

Example: `SENS:SWE:FREQ:YSC:MAX 10DBM`
sets 10 dBm as the upper limit of the measurement diagram.

Manual control: See "[Min - Max y-Axis - Power Analysis](#)" on page 165

:SENSe[:POWer]:SWEep:FREQuency:YSCale:MINimum <Minimum>

This command enters the minimum value for the y axis of the measurement diagram.

Parameters:

<Minimum>	float
	Range: -200 to 100
	Increment: 0.01
	*RST: -40.0 dBm

Example: `SENS:SWE:FREQ:YSC:MIN -10DBM`
sets -10 dBm as the lower limit of the measurement diagram.

Manual control: See "[Min - Max y-Axis - Power Analysis](#)" on page 165

SENSe[:POWer]:SWEep:HCOPy:DATA?

This command queries the measurement data directly. The data is transferred to the remote client as data stream, e.g. for further processing (see [chapter 6.3.3, "SCPI Parameters"](#), on page 337, description of block data).

Readable ASCII data is available for hardcopy language CSV. The representation of the values depends on the selected orientation for the CSV format.

Return values:

<Data>	string
--------	--------

Example:

```
SENS:SWE:HCOP:DEV:LANG CSV
```

selects output format *.csv.

```
SENS:SWE:HCOP:DEV:LANG:CSV:ORI HOR
```

selects horizontal orientation

```
SENS:SWE:HCOP:DEV:LANG:CSV:SEP SEM
```

selects ";" as the separator between the values

```
SENS:SWE:HCOP:DEV:LANG:CSV:DPO DOT
```

selects "." as decimal point

```
SENS:SWE:HCOP:DATA?
```

queries the measurement data of the current traces

Response:

```
#2651009500000;1019000000;1028500000;1038000000
```

```
-9.5;-9.7;-6.3;-2.5
```

The hash symbol # introduces the data block. The next number indicates how many of the following digits describe the length of the data block. In the example the 2 following digit indicates the length to be 65 characters.

Because horizontal representation is selected, a row with all the x-values of the active trace (frequency) follows. The second row contains all the y-values of the active trace (power). The rows end with a new line (each counts as one character).

Note: if more than one trace is active, the third row contains the x values of the second active trace, and so on.

Example:

```
SENS:SWE:HCOP:DEV:LANG:CSV:ORI VERT
```

selects horizontal orientation

```
SENS:SWE:HCOP:DATA?
```

queries the measurement data of the current traces

Response:

```
#2681009500000;-9.5; 1019000000;-9.7; 1028500000;-6.3;
```

```
1038000000;-2.5;
```

for vertical representation the length of the data block is 68 the first power value, the second row contains the second frequency value of the active trace followed by the second power value, and so on. The rows end with a new line (each counts as one character).

Note: if more than one trace is active, the first row also contains the value pairs of the second active trace, and so on.

Usage:

Query only

SENSe[:POWER]:SWEep:HCOPy:DEVIce <Device>

This command defines the output device. The setting is fixed to FILE, i.e. the hardcopy is stored in a file.

Parameters:

<Device>

FILE | PRINter

*RST: FILE

Example: `SENS:SWE:HCOP:DEV FIL`
selects output device file

Manual control: See "[Destination - Power Analysis](#)" on page 185

SENSe[:POWER]:SWEep:HCOPy:DEVIce:LANGUage <Language>

This command selects the bitmap graphic format for the screenshot of the power analysis trace.

In addition, ASCII file format `*.csv` is offered. If file format `*.csv` is selected, the trace data is saved as an ASCII file with comma separated values. It is also possible to directly retrieve the data using command `SENS:SWE:HCOP:DATA?`.

Parameters:

<Language> `BMP | JPG | XPM | PNG | CSV`
*RST: `BMP`

Example: `SENS:SWE:HCOP:DEV:LANG BMP`
selects output format `*.bmp`.

Manual control: See "[Format - Power Analysis](#)" on page 185

SENSe[:POWER]:SWEep:HCOPy:DEVIce:LANGUage:CSV:DPOInt <Dpoint>

This command defines which character should be used as the decimal point of the values, either dot or comma.

Parameters:

<Dpoint> `DOT | COMMA`
*RST: `DOT`

Example: `SENS:SWE:HCOP:DEV:LANG CSV`
selects output format `*.csv`.
`SENS:SWE:HCOP:DEV:LANG:CSV:DPO DOT`
selects character dot for being used as decimal point.

Manual control: See "[CSV Options Hardcopy- Power Analysis](#)" on page 187

SENSe[:POWER]:SWEep:HCOPy:DEVIce:LANGUage:CSV:HEADer <Header>

This command defines whether each row (or column depending on the orientation) should be preceded by a header containing information about the trace (see also [SENSe\[:POWER\]:SWEep:HCOPy:DATA?](#) on page 413).

Parameters:

<Header> `OFF | STANdard`
*RST: `OFF`

Example: SENS : SWE : HCOP : DEV : LANG CSV
 selects output format * . csv.
 SENS : SWE : HCOP : DEV : LANG : CSV : HEAD STAN
 selects the standard header for the * . csv file.

Manual control: See "[CSV Options Hardcopy- Power Analysis](#)" on page 187

SENSe[:POWER]:SWEep:HCOPy:DEVIce:LANGUage:CSV:ORientation
 <Orientation>

This command defines the orientation of the X/Y value pairs. For examples on how the data are arranged see "[CSV Options Hardcopy- Power Analysis](#)" on page 187.

Parameters:
 <Orientation> HORizontal | VERTical
 *RST: HORizontal

Example: SENS : SWE : HCOP : DEV : LANG CSV
 selects output format * . csv.
 SENS : SWE : HCOP : DEV : LANG : CSV : ORI VERT
 selects vertical orientation, the value pairs are written in a column
 like structure (separated by the selected separator, e.g. tab)

Manual control: See "[CSV Options Hardcopy- Power Analysis](#)" on page 187

SENSe[:POWER]:SWEep:HCOPy:DEVIce:LANGUage:CSV[:COLumn]:SEParator
 <Separator>

This command defines which character is to separate the values, either tabulator, semicolon, comma or blank.

Parameters:
 <Separator> TABulator | SEMicolon | COMMa | BLANK
 *RST: SEMIColon

Example: SENS : SWE : HCOP : DEV : LANG CSV
 selects output format * . csv.
 SENS : SWE : HCOP : DEV : LANG : CSV : SEP TAB
 a tab separates the values

Manual control: See "[CSV Options Hardcopy- Power Analysis](#)" on page 187

SENSe[:POWER]:SWEep:HCOPy:DEVIce:SIZE <Size>

This command sets the size of the hardcopy in number of pixels. The first value of the size setting defines the width, the second value the height of the image.

Parameters:
 <Size> 320,240 | 640,480 | 800,600 | 1024,768
 *RST: 320,240

Example: SENS:SWE:HCOP:DEV:LANG BMP
 selects output format *.bmp.
 SENS:SWE:HCOP:DEV:SIZE 320,240
 the size of the bitmap is 320 pixels by 240 pixels.

Manual control: See ["Save Options - Power Analysis"](#) on page 186

SENSe[:POWER]:SWEep:HCOPY[:EXECute]

This command triggers the generation of a hardcopy of the current measurement diagram. The data is written into the file selected/created with the [SENSe\[:POWER\]:SWEep:HCOPY:FILE\[:NAME\]](#) command.

Example: SENS:SWE:HCOP:DEV:LANG BMP
 selects output format *.bmp.
 SENS:SWE:HCOP:FILE:AUTO:STAT OFF
 switches off automatic file naming.
 SENS:SWE:HCOP:FILE 'var/nrp_trace1'
 creates the file nrp_trace1.bmp in the set path.
 SENS:SWE:HCOP
 triggers the generation of a hardcopy of the current measurement diagram. The hardcopy is stored in the file nrp_trace1.bmp.

Usage: Event

Manual control: See ["Save Hardcopy - Power Analysis"](#) on page 186

SENSe[:POWER]:SWEep:HCOPY:FILE[:NAME] <Name>

This command creates/selects a file into which the hardcopy will be stored after the `SENS:SWE:HCOP:EXEC` command is sent. The directory is either defined with the command `MMEMoRY:CDIR` or the path is specified together with the file name. Access to the file via remote control is possible using the commands of the MMEM-Subsystem. In contrast, command `SENSe:SWEep:HCOPY:DATA?` transfers the hardcopy contents directly to the remote client where they can be further processed.

Parameters:

<Name> string

Example: SENS:SWE:HCOP:DEV:LANG BMP
 selects output format *,bmp.
 SENS:SWE:HCOP:FILE:AUTO:STAT OFF
 switches off automatic naming.
 SENS:SWE:HCOP:FILE 'var/trace/nrp_trace1'
 creates the file nrp_trace1.bmp in the trace directory.
 SENS:SWE:HCOP:EXEC
 triggers the generation of a hardcopy of the current trace. The hardcopy is stored in the file nrp_trace1.bmp.

Manual control: See ["File name - Power Analysis"](#) on page 185

SENSe[:POWer]:SWEep:HCOPy:FILE[:NAME]:AUTO:DIRectory <Directory>

This command defines the directory into which the hardcopy files will be stored if auto naming is activated (SENS:SWE:HCOP:FILE:AUTO:STAT ON).

Parameters:

<Directory> string

Example:

SENS:SWE:HCOP:FILE:AUTO:DIR 'var/nrp'
hardcopy file are stored in directory var/nrp if automatic naming is activated.

Manual control: See ["Save Options - Power Analysis"](#) on page 186

SENSe[:POWer]:SWEep:HCOPy:FILE[:NAME]:AUTO:DIRectory:CLEar

This command deletes all files with extensions bmp , img, png, xpm and csv in the directory set for automatic naming.

Example:

SENS:SWE:HCOP:FILE:AUTO:DIR 'var/nrp'
hardcopy file are stored in directory var/nrp if automatic naming is activated.
SENS:SWE:HCOP:FILE:AUTO:DIR:CLE
deletes all hardcopy file that are stored in directory var/nrp.

Usage: Event

Manual control: See ["Save Options - Power Analysis"](#) on page 186

SENSe[:POWer]:SWEep:HCOPy:FILE[:NAME]:AUTO:FILE?

This command query the file name that what generated using the automatic naming settings.

Note: As default the automatically generated file name is composed of: >Path>/<Prefix><YYYY><MM><DD><Number>.<Format>. Each component can be deactivated/activated separately to individually design the file name.

Return values:

<File> string

Example: SENS:SWE:HCOP:DEV:LANG BMP
 selects output format *.bmp.
 SENS:SWE:HCOP:FILE:AUTO:DIR 'var/nrp'
 hardcopy file are stored in directory var/nrp if automatic naming
 is activated.
 SENS:SWE:HCOP:FILE:AUTO:PREFIX 'sens1'
 the file name starts with the prefix sens1. The usage of automatic
 naming with prefix and date in the file name is preset
 (...:STAT ON).
 SENS:SWE:HCOP
 triggers the generation of a hardcopy of the current trace.
 SENS:SWE:HCOP:FILE:AUTO:FILE?
 queries the file name

Usage: Query only

Manual control: See ["File name - Power Analysis"](#) on page 185

SENSe[:POWER]:SWEep:HCOPy:FILE[:NAME]:AUTO[:FILE]:DAY?

This command queries the day of the date part in the automatic file name.

Return values:

<Day> float

Example: SENS:SWE:HCOP:FILE:AUTO:DAY?
 queries the day of the date part in the automatic file name.

Usage: Query only

Manual control: See ["Save Options - Power Analysis"](#) on page 186

SENSe[:POWER]:SWEep:HCOPy:FILE[:NAME]:AUTO[:FILE]:DAY:STATe <State>

This command activates the usage of the day in the automatic file name.

Parameters:

<State> 0 | 1 | OFF | ON
 *RST: ON

Example: SENS:SWE:HCOP:FILE:AUTO:DAY:STAT OFF
 deactivates the usage of the day in the automatic file name.

Manual control: See ["Save Options - Power Analysis"](#) on page 186

SENSe[:POWER]:SWEep:HCOPy:FILE[:NAME]:AUTO[:FILE]:MONTH?

This command queries the day of the date part in the automatic file name.

Return values:

<Month> float

Example: `SENS:SWE:HCOP:FILE:AUTO:MONT?`
queries the month of the date part in the automatic file name.

Usage: Query only

Manual control: See ["Save Options - Power Analysis"](#) on page 186

SENSe[:POWer]:SWEep:HCOPy:FILE[:NAME]:AUTO[:FILE]:MONTH:STATe
<State>

This command activates the usage of the month in the automatic file name.

Parameters:

<State> 0 | 1 | OFF | ON
*RST: ON

Example: `SENS:SWE:HCOP:FILE:AUTO:MONT:STAT OFF`
deactivates the usage of the month in the automatic file name.

Manual control: See ["Save Options - Power Analysis"](#) on page 186

SENSe[:POWer]:SWEep:HCOPy:FILE[:NAME]:AUTO[:FILE]:NUMBer?

This command queries the generated number in the automatic file name.

Return values:

<Number> float

Example: `SENS:SWE:HCOP:FILE:AUTO:NUMB?`
queries the number in the automatic file name.

Usage: Query only

Manual control: See ["Save Options - Power Analysis"](#) on page 186

SENSe[:POWer]:SWEep:HCOPy:FILE[:NAME]:AUTO[:FILE]:PREFix <Prefix>

This command enters the prefix part in the automatic file name.

Parameters:

<Prefix> string

Example: `SENS:SWE:HCOP:FILE:AUTO:PREF 'sensor'`
the prefix sensor is used in the automatically generated file name of the hardcopy file.

Manual control: See ["Save Options - Power Analysis"](#) on page 186

SENSe[:POWer]:SWEep:HCOPy:FILE[:NAME]:AUTO[:FILE]:PREFix:STATe
<State>

This command activates the usage of the prefix in the automatic file name.

Parameters:

<State> 0 | 1 | OFF | ON
 *RST: ON

Example:

SENS:SWE:HCOP:FILE:AUTO:PREFIX:STAT OFF
 deactivates the usage of the prefix in the automatic file name.

Manual control:

See ["Save Options - Power Analysis"](#) on page 186

SENSe[:POWER]:SWEep:HCOPy:FILE[:NAME]:AUTO[:FILE]:YEAR?

This command queries the year of the date part in the automatic file name.

Return values:

<Year> float

Example:

SENS:SWE:HCOP:FILE:AUTO:YEAR?
 queries the year of the date part in the automatic file name.

Usage:

Query only

Manual control:

See ["Save Options - Power Analysis"](#) on page 186

SENSe[:POWER]:SWEep:HCOPy:FILE[:NAME]:AUTO[:FILE]:YEAR:STATe <State>

This command activates the usage of the year in the automatic file name.

Parameters:

<State> 0 | 1 | OFF | ON
 *RST: ON

Example:

SENS:SWE:HCOP:FILE:AUTO:YEAR:STAT OFF
 deactivates the usage of the year in the automatic file name.

Manual control:

See ["Save Options - Power Analysis"](#) on page 186

SENSe[:POWER]:SWEep:HCOPy:FILE[:NAME]:AUTO:STATe <State>

This command activates/deactivates automatic naming of the hardcopy files.

Parameters:

<State> 0 | 1 | OFF | ON
 *RST: ON

Example:

SENS:SWE:HCOP:FILE:AUTO:STAT OFF
 deactivates automatic naming of the hardcopy files. The file name and directory is now defined with command
 SENS:SWE:HCOP:FILE:NAME <path>.

Manual control:

See ["File name - Power Analysis"](#) on page 185

:SENSe[:POWer]:SWEep:INITiate

This command starts the power analysis with NRP power sensor

Example: `SENS:SWE:INIT`
start the power measurement.

Usage: Setting only

Manual control: See "[Start - Power Analysis](#)" on page 157

SENSe[:POWer]:SWEep:MODE <Mode>

This command selects power versus frequency measurement (frequency response), power vs power measurement (power sweep, AM/AM) or power vs. time measurement.

Parameters:

<Mode> FREQUENCY | POWER | TIME
*RST: FREQUENCY

Example: `SENS:SWE:MODE FREQ`
selects frequency mode.

Manual control: See "[Measurement Mode - Power Analysis](#)" on page 161

:SENSe[:POWer]:SWEep:POWer:REference:DATA:COpy

This command generates a reference curve for "Power" measurement.

Example: `SENS:POW:SWE:POW:REF:DATA:COpy`

Example: generates a reference curve in power mode.

Usage: Event

:SENSe[:POWer]:SWEep:POWer:REference:DATA:POINts?

This command reads the number of points from the reference curve in "Power" measurement.

Return values:

<> float

Example: `SENS:POW:SWE:POW:REF:DATA:POIN?`

Example: queries the number of points from the reference curve in power mode.

Usage: Query only

:SENSe[:POWer]:SWEep:POWer:REference:DATA:XVALues <Xvalues>

This command sets or queries the x values of the two reference points, i.e. "Power X (Point A)" and "Power X (Point B)" in "Power" measurement.

Parameters:**<Xvalues>** string**Example:**`SENSe:POW:SWE:POW:REF:DATA:XVAL -15DBM,20DBM`**Example:**

sets the x value of reference "Point A" to -15 dBm, and the value of "Point B" to 20 dBm.

Manual control:See ["Define Reference - Trace Power Analysis"](#) on page 159**:SENSe[:POWer]:SWEep:POWer:REFerence:DATA:YVALues <Yvalues>**

This command sets or queries the y values of the two reference points, i.e. "Power Y (Point A)" and "Power Y (Point B)" in "Power" measurement.

Parameters:**<Yvalues>** string**Example:**`SENSe:POW:SWE:TIME:REF:DATA:YVAL -30,10`**Example:**

sets the y value of reference "Point A" to -30 dBm, and the value of "Point B" to 10 dBm.

Manual control:See ["Define Reference - Trace Power Analysis"](#) on page 159**SENSe[:POWer]:SWEep:POWer:RMODe <Rmode>**

This command selects single or continuous mode for measurement mode power in power analysis.

Parameters:**<Rmode>** SINGLE | CONTInuous
*RST: SINGLE**Example:**`SENS:SWE:POW:RMOD SING`
selects single measurement**Manual control:**See ["Execution - Power Analysis"](#) on page 164**:SENSe<ch>[:POWer]:SWEep:POWer[:SENSor]:OFFSet <Offset>**Defines the level offset at the sensor input in dB. Activate the offset with the command [:SENSe<ch>\[:POWer\]:SWEep:POWer\[:SENSor\]:OFFSet:STATe](#) on page 424.**Parameters:****<Offset>** float
Range: -100 to 100
Increment: 0.01
*RST: 0**Example:**`SENS2:SWE:POW:OFFS -5dB`
defines a level offset of -5 dB.`SENS2:SWE:POW:OFFS:STAT ON`

activates that the specified level offset is taken into account.

Options: Option R&S SMA-K28

Manual control: See "[Level Offset - Power Analysis](#)" on page 172

:SENSe<ch>[:POWer]:SWEep:POWer[:SENSor]:OFFSet:STATe <State>

Activates a level offset at the sensor input. Define the appropriate value with the command [:SENSe<ch>\[:POWer\]:SWEep:POWer\[:SENSor\]:OFFSet](#) on page 423.

Parameters:

<State> 0 | 1 | OFF | ON
*RST: 0

Example: SENS2:SWE:POW:OFFS:STAT ON
activates the specified level offset.

Options: Option R&S SMA-K28

Manual control: See "[Level Offset State- Power Analysis](#)" on page 172

SENSe<ch>[:POWer]:SWEep:POWer[:SENSor]:SFRequency <Sfrequency>

This command defines the separate frequency used for power vs. power measurement.

Parameters:

<Sfrequency> float
*RST: 1 MHz

Example: SENS1:SWE:POW:SENS:SFR 2GHz
'the measurement is performed at 2 GHz

Manual control: See "[Use Separate Frequency- Power Analysis](#)" on page 172

SENSe<ch>[:POWer]:SWEep:POWer[:SENSor]:SFRequency:STATe <State>

This command activates the use of a different frequency for the power measurement.

Parameters:

<State> 0 | 1 | OFF | ON
*RST: OFF

Example: SENS1:SWE:POW:SENS:SFR:STAT ON
activates the use of a separate frequency than the generator frequency for power analysis

Manual control: See "[Use Separate Frequency- Power Analysis](#)" on page 172

:SENSe<ch>[:POWer]:SWEep:TIME[:SENSor]:OFFSet <Offset>

Defines the level offset at the sensor input in dB. Activate the offset with the command [:SENSe<ch>\[:POWer\]:SWEep:TIME\[:SENSor\]:OFFSet:STATe](#).

Parameters:

<Offset> float
 Range: -100 to 100
 Increment: 0.01
 *RST: 0

Example:

SENS2:SWE:TIME:OFFS -7dB
 defines a level offset of -7 dB.
 SENS2:SWE:TIME:OFFS:STAT ON
 activates that the specified level offset is taken into account.

Options:

Option R&S SMA-K28

Manual control:

See "[Level Offset - Power Analysis](#)" on page 172

:SENSe<ch>[:POWer]:SWEep:TIME[:SENSor]:OFFSet:STATe <State>

Activates a level offset at the sensor input. Define the appropriate value with the command `:SENSe<ch>[:POWer]:SWEep:TIME[:SENSor]:OFFSet`.

Parameters:

<State> 0 | 1 | OFF | ON
 *RST: 0

Example:

SENS2:SWE:POW:TIME:STAT ON
 activates the specified level offset.

Options:

Option R&S SMA-K28

Manual control:

See "[Level Offset State- Power Analysis](#)" on page 172

:SENSe<ch>[:POWer]:SWEep:TIME[:SENSor]:PULSe:STATe <State>

This command enables pulse data analysis. The measurement is started with command INITiate.

Note: The command are only available in time measurement mode and with R&S NRP-Z81 power sensors.

Parameters:

<State> 0 | 1 | OFF | ON
 *RST: OFF

Example:

SENS1:SWE:TIM:PULS:STAT ON
 enables pulse data analysis.

Options:

Option R&S SMA-K28

Manual control:

See "[State - Pulse Data Analysis](#)" on page 176

SENSe<ch>[:POWer]:SWEep:TIME[:SENSor]:PULSe:THReshold:BASE <Base>

This command selects how the threshold parameters for pulse analysis are calculated.

Note: The command is only available in time measurement mode and with R&S NRP-Z81 power sensors.

Parameters:

<Base> VOLTage | POWer
*RST: VOLTage

Example:

SENS1 : SWE : TIME : PULS : THR : BASE POW
activates threshold calculation related to power.

Options:

Option R&S SMA-K28

Manual control:

See "[Voltage / Power Related - Pulse Data Analysis](#)" on page 176

**:SENSe<ch>[:POWER]:SWEep:TIME[:SENSor]:PULSe:THReshold:POWER:
HREFerence <HReference>**

This command sets the upper reference level in terms of percentage of the overall pulse level (power or voltage). The distal power defines the end of the rising edge and the start of the falling edge of the pulse.

Note: The command is only available in time measurement mode and with R&S NRP-Z81 power sensors.

Parameters:

<HReference> float
Range: 0 to 100
Increment: 0.01
*RST: 90.0
Default unit: %

Options:

Option R&S SMA-K28

Manual control:

See "[Distal - Pulse Data Analysis](#)" on page 177

**:SENSe<ch>[:POWER]:SWEep:TIME[:SENSor]:PULSe:THReshold:POWER:
REFerence <Reference>**

Sets the medial reference level in terms of percentage of the overall pulse level (power or voltage related). This level is used to define pulse width and pulse period.

Note: The command is only available in time measurement mode and with R&S NRP-Z81 power sensors.

Parameters:

<Reference> float
Range: 0.0 to 100.0
Increment: 0.01
*RST: 50.0
Default unit: %

Example:

SENS1 : SWE : TIM : PULS : THR : REF 40
sets the medial reference level to 40% of the overall pulse level.

Options: Option R&S SMA-K28

Manual control: See "[Mesial - Pulse Data Analysis](#)" on page 177

**:SENSe<ch>[:POWER]:SWEep:TIME[:SENSor]:PULSe:THReshold:POWER:
LREFerence <LReference>**

This command sets the lower reference level in terms of percentage of the overall pulse level. The proximal power defines the start of the rising edge and the end of the falling edge of the pulse.

Note: This parameter is only available in time measurement mode and R&S NRP-Z81 power sensors.

Parameters:

<LReference> float
 Range: 0.0 to 100.0
 Increment: 0.01
 *RST: 10.0
 Default unit: %

Example: SENS:SWE:TIM:PULS:THR:LREF 10
 sets the lower reference level to 10%.

Options: Option R&S SMA-K28

Manual control: See "[Proximal - Pulse Data Analysis](#)" on page 177

SENSe[:POWER]:SWEep:POWER:SPACing[:MODE] <Mode>

This command queries the sweep spacing for the power versus power measurement. The setting is fixed to LINear.

Parameters:

<Mode> LINear
 *RST: LINear

Example: SENS:SWE:POW:SPAC?

Manual control: See "[Spacing - Power Analysis](#)" on page 163

SENSe[:POWER]:SWEep:POWER:STARt <Start>

This command enters the start level for the power versus power measurement.

Parameters:

<Start> float
 *RST: -40 dBm

Example: SENS:SWE:POW:STAR -20.0DBM
 sets the start level to -20 dBm

Manual control: See "[Min - Power Analysis](#)" on page 162

SENSe[:POWer]:SWEep:POWer:STEPs <Steps>

This command enters the number of measurement steps for the power versus power measurement.

Parameters:

<Steps> float
 Range: 10 to 1000
 *RST: 500

Example: SENS:SWE:POW:STEP 500
 sets the 500 measurement steps

Manual control: See ["Steps - Power Analysis"](#) on page 163

SENSe[:POWer]:SWEep:POWer:STOP <Stop>

This command enters the stop level for the power versus power measurement.

Parameters:

<Stop> float
 *RST: 30.0 dBm

Example: SENS:SWE:POW:STOP 20.0DBM
 sets the stop level to 20 dBm

Manual control: See ["Max - Power Analysis"](#) on page 162

SENSe[:POWer]:SWEep:POWer:TIMing[:MODE] <Mode>

This command selects the timing mode of the measurement.

Parameters:

<Mode> FAST | NORMAl | HPRecision

FAST

Selection FAST leads to a fast measurement with a short integration times for each measurement step.

NORMAl

NORMAl leads to a longer but more precise measurement due to a higher integration time for each step.

*RST: NORMAl

Example: SENS:SWE:POW:TIM:MODE FAST
 selects fast mode.

Manual control: See ["Timing - Power Analysis"](#) on page 163

SENSe[:POWer]:SWEep:POWer:YScale:AUTO <Auto>

This command activates/deactivates autoscaling of the Y axis of the diagram.

Parameters:

<Auto>

OFF | CEXPanding | FEXPanding | CFLoating | FFLoating

OFF

Auto scaling is deactivated. When switching from activated to deactivated Auto scaling, the scaling is maintained. When switching from deactivated to activated Auto scaling, the scaling is reset to min = max = 0.

CEXPanding | FEXPanding

Auto scale is activated. The scaling of the Y-axis is selected in such a way, that the trace is always visible. To this end, the range is expanded if the minimum or maximum values of the trace move outside the current scale. The step width is 5 dB for selection course and variable in the range of 0.2 db to 5 dB for selection fine.

CFLoating | FFLoating

Auto scale is activated. The scaling of the Y-axis is selected in such a way, that the trace is always visible. To this end, the range is either expanded if the minimum or maximum values of the trace move outside the current scale or scaled down if the trace fits into a reduced scale. The step width is 5 dB for selection course and variable in the range of 0.2 db to 5 dB for selection fine.

*RST: OFF

Example:

SENS:SWE:POW:YSC:AUTO OFF

deactivates auto scale

Manual control:See "[Auto Scale - Power Analysis](#)" on page 165**SENSe[:POWer]:SWEep:POWer:YSCale:AUTO:RESet**

This command resets the Y scale to suitable values after the use of auto scaling in the expanding mode. For this mode, the scale might get expanded because of temporarily high power values. The reset function allows resetting the diagram to match smaller power values again.

Example:

SENS:SWE:POW:YSC:AUTO:RES

resets auto scale

Usage:

Event

Manual control:See "[Reset Auto Scale - Power Analysis](#)" on page 166**SENSe[:POWer]:SWEep:POWer:YSCale:MAXimum <Maximum>**

This command enters the maximum value for the y axis of the measurement diagram.

Parameters:

<Maximum>

float

Range: min level to max level

*RST: 40 dBm

Example: `SENS:SWE:POW:YSC:MAX 10DBM`
sets 10 dBm as the upper limit of the measurement diagram.

Manual control: See ["Min - Max y-Axis - Power Analysis"](#) on page 165

SENSe[:POWer]:SWEp:POWer:YSCale:MINimum <Minimum>

This command enters the minimum value for the y axis of the measurement diagram.

Parameters:

<Minimum> float
Range: min level to max level
*RST: -40 dBm

Example: `SENS:SWE:POW:YSC:MIN -10DBM`
sets -10 dBm as the lower limit of the measurement diagram.

Manual control: See ["Min - Max y-Axis - Power Analysis"](#) on page 165

SENSe[:POWer]:SWEp:RMODE <Rmode>

This command selects single or continuous mode for power analysis (all measurement modes).

Parameters:

<Rmode> SINGLE | CONTInuous
*RST: SINGLE

Example: `SENS:SWE:RMODE SING`
selects single measurement

Manual control: See ["Execution - Power Analysis"](#) on page 164

SENSe[:POWer]:SWEp:TIME:RMODE <Rmode>

This command selects single or continuous mode for measurement mode time in power analysis.

Parameters:

<Rmode> SINGLE | CONTInuous
*RST: SINGLE

Example: `SENS:SWE:TIME:RMODE SING`
selects single measurement

Manual control: See ["Execution - Power Analysis"](#) on page 164

:SENSe[:POWer]:SWEep:TIME:AVERage[:COUNT] <Count>

This command selects the averaging factor in time mode. The count number determines how many measurement cycles are used to form a measurement result. Higher averaging counts reduce noise but increase the measurement time. Averaging requires a stable trigger event so that the measurement cycles have the same timing.

Parameters:

<Count> 1 | 2 | 4 | 8 | 16 | 32 | 64 | 128 | 256 | 512 | 1024
*RST: NORMal

Example:

```
SENS:SWE:MODE TIME
selects time mode
SENS:SWE:TIME:AVER 128
selects averaging factor 128
```

Options:

Option R&S SMA-K28

Manual control:

See ["Average - Power Analysis"](#) on page 163

:SENSe[:POWer]:SWEep:TIME:REFerence:DATA:COPY

This command generates a reference curve for "Time" measurement.

Example:

```
SENS:POW:SWE:TIME:REF:DATA:COPY
```

Example:

generates a reference curve in time mode.

Usage:

Event

Manual control:

See ["Define Reference - Trace Power Analysis"](#) on page 159

:SENSe[:POWer]:SWEep:TIME:REFerence:DATA:POINTS?

This command reads the number of points from the reference curve in "Time" measurement.

Return values:

<> float

Example:

```
SENS:POW:SWE:TIME:REF:DATA:POIN?
```

Example:

queries the number of points from the reference curve in time mode.

Usage:

Query only

:SENSe[:POWer]:SWEep:TIME:REFerence:DATA:XVALues <Xvalues>

This command sets or queries the x values of the two reference points, i.e. "Time X (Point A)" and "Time X (Point B)" in "Time" measurement.

Parameters:

<Xvalues> string

- Example:** `SENSe:POW:SWE:TIME:REF:DATA:XVAL 5,45`
- Example:** sets the x value of reference "Point A" to 5 μ s, and the value of "Point B" to 45 μ s.
- Manual control:** See ["Define Reference - Trace Power Analysis"](#) on page 159

`:SENSe[:POWer]:SWEep:TIME:REFerence:DATA:YVALues <Yvalues>`

This command sets or queries the y values of the two reference points, i.e. "Power Y (Point A)" and "Power Y (Point B)" in "Time" measurement.

Parameters:

<Yvalues> string

Example: `SENSe:POW:SWE:TIME:REF:DATA:YVAL -30,10`

Example: sets the y value of reference "Point A" to -30 dBm, and the value of "Point B" to 10 dBm.

Manual control: See ["Define Reference - Trace Power Analysis"](#) on page 159

`SENSe<ch>[:POWer]:SWEep:TIME[:SENSor]:SFRequency <Sfrequency>`

This command defines the separate frequency used for power vs. time measurement.

Parameters:

<Sfrequency> float
*RST: 1 MHz

Example: `SENS1:SWE:TIME:SENS:SFR 2GHz`
the measurement is performed at 2 GHz

Manual control: See ["Use Separate Frequency- Power Analysis"](#) on page 172

`SENSe<ch>[:POWer]:SWEep:TIME[:SENSor]:SFRequency:STATe <State>`

This command activates the use of a different frequency for the power measurement.

Parameters:

<State> 0 | 1 | OFF | ON
*RST: OFF

Example: `SENS1:SWE:TIME:SENS:SFR:STAT ON`
activates the use of a separate frequency than the generator frequency for power analysis

Manual control: See ["Use Separate Frequency- Power Analysis"](#) on page 172

`SENSe<ch>[:POWer]:SWEep:TIME[:SENSor]:TRIGger:AUTO <Auto>`

This command sets the trigger level, the hysteresis and the dropout time to default values.

Parameters:

<Auto> ONCE

Example:

SENS1:SWE:TIME:SENS:TRIG:AUTO ONCE
the trigger level is automatically determined

Manual control:

See ["Auto Set - Power Analysis"](#) on page 183

SENSe<ch>[:POWER]:SWEep:TIME[:SENSor]:TRIGger:DTIME <Dtime>

This command determines the minimum time for which the signal must be below (above) the power level defined by level and hysteresis before triggering can occur again.

Parameters:

<Dtime> float
Range: 0.0 to 10.0
*RST: 0
Default unit: s

Example:

SENS1:SWE:TIME:SENS:TRIG:DTIM 10 us
the drop out time is 10 us

Manual control:

See ["Drop out Time - Power Analysis"](#) on page 183

SENSe<ch>[:POWER]:SWEep:TIME[:SENSor]:TRIGger:HYSTeresis <Hysteresis>

This command sets the hysteresis of the internal trigger threshold. Hysteresis is the magnitude (in dB) the trigger signal level must drop below the trigger threshold (positive trigger slope) before triggering can occur again.

Parameters:

<Hysteresis> float
Range: -10.0 to 10.0
*RST: 0.5
Default unit: dB

Example:

SENS1:SWE:TIME:SENS:TRIG:HYST 0.5 dB
the hysteresis is 0.5 dB

Manual control:

See ["Hysteresis - Power Analysis"](#) on page 183

SENSe<ch>[:POWER]:SWEep:TIME[:SENSor]:TRIGger:LEVel <Level>

This command sets the trigger threshold.

Parameters:

<Level> float
Range: -200.0 to 100.0
*RST: 1
Default unit: dBm

Example:

SENS1:SWE:TIME:SENS:TRIG:LEV -20 dBm
sets the trigger level to -20 dBm.

Manual control: See "[Level - Power Analysis](#)" on page 182

:SENSe<ch>[:POWer]:SWEep:TIME[:SENSor]:TRIGger:SLOPe <TriggerSlope>

The command sets the polarity of the active slope for the trigger signals.

Parameters:

<TriggerSlope> POSitive | NEGative
*RST: POSitive

Example:

SENS1:SWE:TIME:TRIG:SLOP POS
the positive edge of a trigger signal is active.

Options: Option R&S SMA-K28

SENSe<ch>[:POWer]:SWEep:TIME[:SENSor]:TRIGger:SOURce <Source>

This command selects if the measurement is free running (FREE) or starts only after a trigger event. The trigger can be applied internally or externally.

Parameters:

<Source> FREE | AUTO | INTernal | EXTernal
*RST: AUTO

Example:

SENS1:SWE:TIME:SENS:TRIG:SOUR FREE
the power versus time measurement is performed free running

Manual control: See "[Mode - Power Analysis](#)" on page 182

SENSe[:POWer]:SWEep:TIME:SPACing[:MODE]?

This command queries the sweep spacing for the power versus time measurement. The spacing is fixed to linear.

Return values:

<Mode> LINear
*RST: LINear

Example:

SENS:SWE:TIME:SPAC?
queries the sweep spacing

Usage: Query only

Manual control: See "[Spacing - Power Analysis](#)" on page 163

SENSe[:POWer]:SWEep:TIME:STARt <Start>

This command enters the start time for the power versus time measurement. Value 0 defines the trigger point. By choosing a negative time value, the trace can be shifted in the diagram. It is possible, that the measurement cannot be performed over the complete time range because of limitations due to sensor settings. In this case, an error message is output.

Parameters:

<Start> float
 Range: -1.0 to 1.0
 *RST: 0
 Default unit: s

Example:

SENS:SWE:TIME:STAR 0s
 sets the start time to 0 s

Manual control: See ["Min - Power Analysis"](#) on page 162

SENSe[:POWer]:SWEep:TIME:STEPs <Steps>

This command enters the number of measurement steps for the power versus time measurement. Value 0 defines the trigger point.

Parameters:

<Steps> float
 Range: 10 to 1000
 *RST: 200

Example:

SENS:SWE:TIME:STEP 500
 sets the 500 measurement steps

Manual control: See ["Steps - Power Analysis"](#) on page 163

SENSe[:POWer]:SWEep:TIME:STOP <Stop>

This command enters the stop time for the power versus time measurement.

Parameters:

<Stop> float
 Range: 0.0 to 2.0
 *RST: 1.0ms
 Default unit: s

Example:

SENS:SWE:TIME:STOP 1ms
 sets the stop time to 1 ms

Manual control: See ["Max - Power Analysis"](#) on page 162

:SENSe[:POWer]:SWEep:TIME:TEVents <TriggerEvents>

This command determines, whether the measurement data processing starts with a trigger event in one of the sensors (Logical OR), or whether all channels have to be triggered (logical AND). Each sensor evaluates a trigger event according to its setting independently. This function supports the internal or external trigger modes with multi-channel time measurements.

Parameters:

<TriggerEvents> AND | OR
 *RST: AND

- Example:** `SENS:POW:SWE:TIME:TEV AND`
the measurement data processing starts when all channels are triggered.
- Options:** Option R&S SMA-K28
- Manual control:** See "[All Trigger Events - Power Analysis](#)" on page 164

SENSe[:POWer]:SWEep:TIME:YSCale:AUTO <Auto>

This command activates/deactivates autoscaling of the Y axis of the diagram..

Parameters:

<Auto>

OFF | CEXPanding | FEXPanding | CFLoating | FFLoating

OFF

Auto scaling is deactivated. When switching from activated to deactivated Auto scaling, the scaling is maintained. When switching from deactivated to activated Auto scaling, the scaling is reset to min = max = 0.

CEXPanding | FEXPanding

Auto scale is activated. The scaling of the Y-axis is selected in such a way, that the trace is always visible. To this end, the range is expanded if the minimum or maximum values of the trace move outside the current scale. The step width is 5 dB for selection course and variable in the range of 0.2 db to 5 dB for selection fine.

CFLoating | FFLoating

Auto scale is activated. The scaling of the Y-axis is selected in such a way, that the trace is always visible. To this end, the range is either expanded if the minimum or maximum values of the trace move outside the current scale or scaled down if the trace fits into a reduced scale. The step width is 5 dB for selection course and variable in the range of 0.2 db to 5 dB for selection fine.

*RST: OFF

- Example:** `SENS:SWE:TIME:YSC:AUTO OFF`
deactivates auto scale

- Manual control:** See "[Auto Scale - Power Analysis](#)" on page 165

SENSe[:POWer]:SWEep:TIME:YSCale:AUTO:RESet

This command resets the Y scale to suitable values after the use of auto scaling in the expanding mode. For this mode, the scale might get expanded because of temporarily high power values. The reset function allows resetting the diagram to match smaller power values again.

- Example:** `SENS:SWE:TIME:YSC:AUTO:RES`
resets auto scale

- Usage:** Event

Manual control: See ["Reset Auto Scale - Power Analysis"](#) on page 166

SENSe[:POWER]:SWEep:TIME:YSCale:MAXimum <Maximum>

This command enters the maximum value for the y axis of the measurement diagram.

Parameters:

<Maximum> float
 Range: min level to max level
 *RST: 40
 Default unit: dBm

Example: SENS:SWE:TIME:YSC:MAX 10DBM
 sets 10 dBm as the upper limit of the measurement diagram.

Manual control: See ["Min - Max y-Axis - Power Analysis"](#) on page 165

SENSe[:POWER]:SWEep:TIME:YSCale:MINimum <Minimum>

This command enters the minimum value for the y axis of the measurement diagram.

Parameters:

<Minimum> float
 Range: min level to max level
 *RST: -40
 Default unit: dBm

Example: SENS:SWE:TIME:YSC:MIN -10DBM
 sets -10 dBm as the lower limit of the measurement diagram.

Manual control: See ["Min - Max y-Axis - Power Analysis"](#) on page 165

SENSe<ch>[:POWER]:TYPE?

The command queries the type of sensor. The type is automatically detected.

Return values:

<Type> string

Example: SENS:TYPE?
 queries the type of sensor connected to the POWER SENSOR connector.
 Response: NRP-Z21
 the R&S NRP-Z21 sensor is used.

Usage: Query only

Manual control: See ["Current Sensors"](#) on page 89

SENSe<ch>[:POWer]:ZERO

The command activates the autozero function. Zeroing is required in regular interval (at least once a day) and if the temperature has varied more than about 5 °C, if the sensor has been replaced or if measurements of signals with very low power are to be performed. The RF power source must be switched off or disconnected from the sensor before starting the autozero function.

Example: SENS : ZERO
 activates autozero function.

Usage: Event

Manual control: See "[Zero - Power Sensors](#)" on page 136

SENSe<ch>:UNIT[:POWer] <Power>

The command selects the unit used for result query with command READ. The power sensor provides the measured value in Watt. In which unit the measured value is returned is selected here and might be either Watt, dBm or dBuV.

Parameters:
<Power> DBM | DBUV | WATT
 *RST: DBM

Example: SENS2 : UNIT DBM
 selects unit dBm for the measured value returned by command
 READ.
 READ2 ?
 Response : 7.34
 7.34 dBm are measured by sensor 2.

Manual control: See "[Unit - Power Sensors](#)" on page 148

7.12.6 TRACe Subsystem

:TRACe<ch>[:POWer]:SWEep:COLor.....	440
:TRACe<ch>[:POWer]:SWEep:COPY.....	440
:TRACe<ch>[:POWer]:SWEep:DATA:POINts?.....	440
:TRACe<ch>[:POWer]:SWEep:DATA:XVALues?.....	441
:TRACe<ch>[:POWer]:SWEep:DATA:YVALues?.....	441
:TRACe<ch>[:POWer]:SWEep:FEED.....	441
:TRACe[:POWer]:SWEep:MEASurement:FULLscreen:DISPlay:ANNotation[:STATe].....	442
:TRACe[:POWer]:SWEep:MEASurement:GATE:DISPlay:ANNotation[:STATe].....	442
:TRACe[:POWer]:SWEep:MEASurement:MARKer:DISPlay:ANNotation[:STATe].....	443
:TRACe<ch>[:POWer]:SWEep:MEASurement:POWer:AVERage?.....	443
:TRACe<ch>[:POWer]:SWEep:MEASurement:POWer:HREFerence?.....	443
:TRACe<ch>[:POWer]:SWEep:MEASurement:POWer:LREFerence?.....	443
:TRACe<ch>[:POWer]:SWEep:MEASurement:POWer:MAXimum?.....	443
:TRACe<ch>[:POWer]:SWEep:MEASurement:POWer:MINimum?.....	443
:TRACe<ch>[:POWer]:SWEep:MEASurement:POWer:PULSe:BASE?.....	443

:TRACe<ch>[:POWer]:SWEep:MEASurement:POWer:PULSe:TOP?	443
:TRACe<ch>[:POWer]:SWEep:MEASurement:POWer:REFerence?	443
:TRACe<ch>[:POWer]:SWEep:MEASurement:PULSe:DCYClE?	443
:TRACe<ch>[:POWer]:SWEep:MEASurement:PULSe:DURation?	443
:TRACe<ch>[:POWer]:SWEep:MEASurement:PULSe:PERiod?	443
:TRACe<ch>[:POWer]:SWEep:MEASurement:PULSe:SEParation?	443
:TRACe<ch>[:POWer]:SWEep:MEASurement:PULSe:STATe?	443
:TRACe<ch>[:POWer]:SWEep:MEASurement:TRANSition:NEGative:DURation?	443
:TRACe<ch>[:POWer]:SWEep:MEASurement:TRANSition:NEGative:OCCurrence?	443
:TRACe<ch>[:POWer]:SWEep:MEASurement:TRANSition:NEGative:OVERshoot?	443
:TRACe<ch>[:POWer]:SWEep:MEASurement:TRANSition:POSitive:DURation?	443
:TRACe<ch>[:POWer]:SWEep:MEASurement:TRANSition:POSitive:OCCurrence?	443
:TRACe<ch>[:POWer]:SWEep:MEASurement:TRANSition:POSitive:OVERshoot?	443
:TRACe[:POWer]:SWEep:MEASurement:PULSe:DISPlay:ANNotation[:STATe]	444
:TRACe<ch>[:POWer]:SWEep:MEASurement:PULSe:ALL:DISPlay:ANNotation[:STATe]	444
:TRACe[:POWer]:SWEep:MEASurement:STANdard:DISPlay:ANNotation[:STATe]	444
:TRACe<ch>[:POWer]:SWEep:MEASurement:PULSe:DCYClE:DISPlay:ANNotation[: STATe]	445
:TRACe<ch>[:POWer]:SWEep:MEASurement:PULSe:DURation:DISPlay:ANNotation[: STATe]	445
:TRACe<ch>[:POWer]:SWEep:MEASurement:PULSe:PERiod:DISPlay:ANNotation[: STATe]	445
:TRACe<ch>[:POWer]:SWEep:MEASurement:POWer:AVERage:DISPlay:ANNotation[: STATe]	445
:TRACe<ch>[:POWer]:SWEep:MEASurement:POWer:PULSe:BASE:DISPlay: ANNotation[:STATe]	445
:TRACe<ch>[:POWer]:SWEep:MEASurement:POWer:HREFerence:DISPlay: ANNotation[:STATe]	445
:TRACe<ch>[:POWer]:SWEep:MEASurement:POWer:LREFerence:DISPlay: ANNotation[:STATe]	445
:TRACe<ch>[:POWer]:SWEep:MEASurement:POWer:MAXimum:DISPlay:ANNotation[: STATe]	445
:TRACe<ch>[:POWer]:SWEep:MEASurement:POWer:MINimum:DISPlay:ANNotation[: STATe]	445
:TRACe<ch>[:POWer]:SWEep:MEASurement:POWer:REFerence:DISPlay: ANNotation[:STATe]	445
:TRACe<ch>[:POWer]:SWEep:MEASurement:POWer:PULSe:TOP:DISPlay: ANNotation[:STATe]	445
:TRACe<ch>[:POWer]:SWEep:MEASurement:PULSe:SEParation:DISPlay: ANNotation[:STATe]	445
:TRACe<ch>[:POWer]:SWEep:MEASurement:TRANSition:NEGative:DURation: DISPlay:ANNotation[:STATe]	445
:TRACe<ch>[:POWer]:SWEep:MEASurement:TRANSition:NEGative:OCCurrence: DISPlay:ANNotation[:STATe]	445
:TRACe<ch>[:POWer]:SWEep:MEASurement:TRANSition:NEGative:OVERshoot: DISPlay:ANNotation[:STATe]	445
:TRACe<ch>[:POWer]:SWEep:MEASurement:TRANSition:POSitive:DURation:DISPlay: ANNotation[:STATe]	445
:TRACe<ch>[:POWer]:SWEep:MEASurement:TRANSition:POSitive:OCCurrence: DISPlay:ANNotation[:STATe]	445

:TRACe<ch>[:POWer]:SWEep:MEASurement:TRANSition:POSitive:OVERshoot: DISPlay:ANNotation[:STATe].....	445
:TRACe<ch>[:POWer]:SWEep:PULSe:THReshold:BASE?.....	446
:TRACe<ch>[:POWer]:SWEep:PULSe:THReshold:POWer:HREFerence?.....	446
:TRACe<ch>[:POWer]:SWEep:PULSe:THReshold:POWer:REFerence?.....	447
:TRACe<ch>[:POWer]:SWEep:PULSe:THReshold:POWer:LREFerence?.....	447
:TRACe<ch>[:POWer]:SWEep:STATe.....	447

:TRACe<ch>[:POWer]:SWEep:COLor <Color>

This command defines the color of each trace..

Parameters:

<Color> INVers | GRAY | YELLow | BLUE | GREen | RED | MAGenta
*RST: trace 1 = YELLow, trace 2 = GREen, trace 3 = RED.

Example:

TRAC2:SWE:COL GRAY
trace2 is indicated in gray color

Manual control: See "[Color - Trace Power Analysis](#)" on page 161

:TRACe<ch>[:POWer]:SWEep:COPIY <Copy>

This commands stores the selected trace data as reference trace.

Parameters:

<Copy> REFerence

Example:

TRAC2:SWE:COPIY REF
stores the current trace2 as reference trace'
TRAC1:SWE:FEED REF
assigns the reference trace to trace 1.

Manual control: See "[Indication - Power Analysis](#)" on page 158

:TRACe<ch>[:POWer]:SWEep:DATA:POINts?

This commands queries the number of measurement points of the selected trace of the current power analysis.

Return values:

<Points> float

Example:

TRAC1:SWE:DATA:POIN?
Response: 624
Measurement trace 1 contains 624 measurement points

Usage: Query only

Manual control: See "[Start - Power Analysis](#)" on page 157

:TRACe<ch>[:POWer]:SWEep:DATA:XVALues?

This commands queries the x-axis values - frequency, power or time values - of the selected trace of the current power analysis.

Return values:

<Xvalues> string

Example:

```
SENS:SWE:MODE FREQ
sets measurement mode frequency versus power.
SENS:SWE:RMODE SING
selects single measurement.
SENS:SWE:INIT
starts the measurement.
*OPC?
waits until measurement is performed.
TRAC1:SWE:DATA:XVAL?
queries the x-axis values of trace 1.
TRAC1:SWE:DATA:YVAL
queries the measurement values of trace 1.
```

Usage: Query only

Manual control: See "[Start - Power Analysis](#)" on page 157

:TRACe<ch>[:POWer]:SWEep:DATA:YVALues?

This commands queries the measurement (y-axis) values of the selected trace of the current power analysis.

Return values:

<Yvalues> string

Example:

```
SENS:SWE:TRAC2:DATA:YVAL?
queries the power values of trace 2.
```

Usage: Query only

Manual control: See "[Start - Power Analysis](#)" on page 157

:TRACe<ch>[:POWer]:SWEep:FEED <Feed>

This command selects the source for the trace data.

Parameters:

<Feed> SENSor1 | SENSor2 | SENSor3 | REFerence | NONE

*RST: The preset value for each trace is evaluated during runtime as follows: If a sensor is plugged into the generator whose number corresponds to the trace number, this sensor is used to feed the trace and the state of the trace is ON; If no sensor is found with number corresponding to the trace number, the preset value of the trace is "Off".

Example:

```
TRAC2:SWE:COPY REF
stores trace2 as reference trace.
TRAC1:SWE:FEED REF
assigns the reference trace to trace 1.
TRAC1:SWE:STAT ON
assigns the reference trace to trace 1.
SENS:SWE:RMOD SING
selects single measurement
SENS:SWE:INIT
starts the measurement
```

Manual control: See ["Indication - Power Analysis"](#) on page 158

:TRACe[:POWER]:SWEep:MEASurement:FULLscreen:DISPlay:ANNotation[:STATe] <State>

This command selects fullscreen display, only the diagram is displayed in the measurement diagram and in the hardcopy file.

Parameters:

<State> 0 | 1 | OFF | ON
*RST: OFF

Example:

```
TRAC:SWE:MEAS:FULL:DISP:ANN ON
the display only shows the diagram.
```

Options: Option R&S SMA-K28

Manual control: See ["REARR list - Power Analysis"](#) on page 166

:TRACe[:POWER]:SWEep:MEASurement:GATE:DISPlay:ANNotation[:STATe] <State>

This command selects if the time gate borders and values are indicated in the measurement diagram and in the hardcopy file. The gate settings are performed with the `CALC:POW:SWE:TIME:GATE:...` commands.

Parameters:

<State> 0 | 1 | OFF | ON
*RST: OFF

Example:

```
TRAC:SWE:MEAS:GATE:DISP:ANN ON
the diagram also shows the gate information.
```

Options: Option R&S SMA-K28

Manual control: See ["REARR list - Power Analysis"](#) on page 166

```
:TRACe[:POWer]:SWEep:MEASurement:MARKer:DISPlay:ANNotation[:STATe]
<State>
```

This command selects if the markers and the marker list are indicated in the measurement diagram and in the hardcopy file..

Parameters:

```
<State>          0 | 1 | OFF | ON
                  *RST:      OFF
```

Example:

```
TRAC : SWE : MEAS : MARK : DISP : ANN ON
the diagram also shows the marker information.
```

Options:

Option R&S SMA-K28

Manual control:

See "[Marker and Pulse Data Indication - Power Analysis](#)" on page 155

```
:TRACe<ch>[:POWer]:SWEep:MEASurement:POWer:AVERAge?
:TRACe<ch>[:POWer]:SWEep:MEASurement:POWer:HREFerence?
:TRACe<ch>[:POWer]:SWEep:MEASurement:POWer:LREFerence?
:TRACe<ch>[:POWer]:SWEep:MEASurement:POWer:MAXimum?
:TRACe<ch>[:POWer]:SWEep:MEASurement:POWer:MINimum?
:TRACe<ch>[:POWer]:SWEep:MEASurement:POWer:PULSe:BASE?
:TRACe<ch>[:POWer]:SWEep:MEASurement:POWer:PULSe:TOP?
:TRACe<ch>[:POWer]:SWEep:MEASurement:POWer:REFerence?
:TRACe<ch>[:POWer]:SWEep:MEASurement:PULSe:DCYCLE?
:TRACe<ch>[:POWer]:SWEep:MEASurement:PULSe:DURation?
:TRACe<ch>[:POWer]:SWEep:MEASurement:PULSe:PERiod?
:TRACe<ch>[:POWer]:SWEep:MEASurement:PULSe:SEPAration?
:TRACe<ch>[:POWer]:SWEep:MEASurement:PULSe:STATe?
:TRACe<ch>[:POWer]:SWEep:MEASurement:TRANSition:NEGative:DURation?
:TRACe<ch>[:POWer]:SWEep:MEASurement:TRANSition:NEGative:
  OCCurrence?
:TRACe<ch>[:POWer]:SWEep:MEASurement:TRANSition:NEGative:OVERshoot?
:TRACe<ch>[:POWer]:SWEep:MEASurement:TRANSition:POSitive:DURation?
:TRACe<ch>[:POWer]:SWEep:MEASurement:TRANSition:POSitive:OCCurrence?
:TRACe<ch>[:POWer]:SWEep:MEASurement:TRANSition:POSitive:OVERshoot?
```

The listed commands query the measured pulse parameters values.

Note: These commands are only available in time measurement mode and with R&S NRP-Z81 power sensors.

Return values:

```
<Overshoot>      float
```

Example:

```
TRAC1 : SWE : MEAS : POW : HREF ?
queries the measured mesial threshold level of trace 1
TRAC3 : SWE : MEAS : POW : MAX ?
queries the measured peak power of trace 3
```

Usage:

Query only

Options: Option R&S SMA-K28

Manual control: See "[Transition Times - Pulse Data Analysis](#)" on page 178

**:TRACe[:POWer]:SWEep:MEASurement:PULSe:DISPlay:ANNOtation[:STATe]
<State>**

This command selects if the pulse data is shown below the measurement diagram and also stored in the hardcopy file. The parameters to be indicated can be selected with the following `TRAC:SWE:MEAS:...` commands. Only six parameters are indicated at one time.

Note: This command is only available in time measurement mode and with R&S NRP-Z81 power sensors.

Parameters:

<State> 0 | 1 | OFF | ON
*RST: OFF

Example: `TRAC:SWE:MEAS:PULS:DISP:ANN ON`
activates indication of the selected pulse data.

Options: Option R&S SMA-K28

Manual control: See "[Marker and Pulse Data Indication - Power Analysis](#)" on page 155

**:TRACe<ch>[:POWer]:SWEep:MEASurement:PULSe:ALL:DISPlay:ANNOtation[:
STATe] <State>**

This command switches the indication of all pulse data of the selected trace off. The parameters to be indicated can be selected with the following `TRAC:SWE:MEAS:...` commands. Only six parameters are indicated at one time.

Note: This command is only available in time measurement mode and with R&S NRP-Z81 power sensors.

Parameters:

<State> 0 | 1 | OFF | ON
*RST: OFF

Example: `TRAC:SWE:MEAS:PULS:ALL:DISP:ANN OFF`
switches the indication of all pulse data off

Options: Option R&S SMA-K28

**:TRACe[:POWer]:SWEep:MEASurement:STANdard:DISPlay:ANNOtation[:STATe]
<State>**

This command selects the standard view, i.e. diagram and buttons but no lists are displayed and also stored in the hardcopy file.

Parameters:

<State> 0 | 1 | OFF | ON
 *RST: ON

Example:

TRAC:SWE:MEAS:STAN:DISP:ANN ON
 activates indication of the selected pulse data

Options:

Option R&S SMA-K28

Manual control:

See "[REARR list - Power Analysis](#)" on page 166

```

:TRACE<ch>[:POWER]:SWEep:MEASurement:PULSe:DCYClE:DISPlay:
  ANNotation[:STATe] <State>
:TRACE<ch>[:POWER]:SWEep:MEASurement:PULSe:DURation:DISPlay:
  ANNotation[:STATe] <State>
:TRACE<ch>[:POWER]:SWEep:MEASurement:PULSe:PERiod:DISPlay:
  ANNotation[:STATe] <State>
:TRACE<ch>[:POWER]:SWEep:MEASurement:POWEr:AVErAge:DISPlay:
  ANNotation[:STATe] <State>
:TRACE<ch>[:POWER]:SWEep:MEASurement:POWEr:PULSe:BASE:DISPlay:
  ANNotation[:STATe] <State>
:TRACE<ch>[:POWER]:SWEep:MEASurement:POWEr:HREFerence:DISPlay:
  ANNotation[:STATe] <State>
:TRACE<ch>[:POWER]:SWEep:MEASurement:POWEr:LREFerence:DISPlay:
  ANNotation[:STATe] <State>
:TRACE<ch>[:POWER]:SWEep:MEASurement:POWEr:MAXimum:DISPlay:
  ANNotation[:STATe] <State>
:TRACE<ch>[:POWER]:SWEep:MEASurement:POWEr:MINimum:DISPlay:
  ANNotation[:STATe] <State>
:TRACE<ch>[:POWER]:SWEep:MEASurement:POWEr:REFerence:DISPlay:
  ANNotation[:STATe] <State>
:TRACE<ch>[:POWER]:SWEep:MEASurement:POWEr:PULSe:TOP:DISPlay:
  ANNotation[:STATe] <State>
:TRACE<ch>[:POWER]:SWEep:MEASurement:PULSe:SEPAration:DISPlay:
  ANNotation[:STATe] <State>
:TRACE<ch>[:POWER]:SWEep:MEASurement:TRANSition:NEGAtive:DURation:
  DISPlay:ANNotation[:STATe] <State>
:TRACE<ch>[:POWER]:SWEep:MEASurement:TRANSition:NEGAtive:OCCurrence:
  DISPlay:ANNotation[:STATe] <State>
:TRACE<ch>[:POWER]:SWEep:MEASurement:TRANSition:NEGAtive:OVERshoot:
  DISPlay:ANNotation[:STATe] <State>
:TRACE<ch>[:POWER]:SWEep:MEASurement:TRANSition:POSitive:DURation:
  DISPlay:ANNotation[:STATe] <State>
:TRACE<ch>[:POWER]:SWEep:MEASurement:TRANSition:POSitive:OCCurrence:
  DISPlay:ANNotation[:STATe] <State>
:TRACE<ch>[:POWER]:SWEep:MEASurement:TRANSition:POSitive:OVERshoot:
  DISPlay:ANNotation[:STATe] <State>

```

The listed commands select the pulse parameters which are indicated in the display and hardcopy file. Only six parameters can be indicated at one time.

Note: These commands are only available in time measurement mode and with R&S NRP-Z81 power sensors.

Parameters:

<State> 0 | 1 | OFF | ON
*RST: OFF

Example:

TRAC:SWE:MEAS:TRAC2:PULS:PER:DISP:ANN ON
selects the pulse period to be indicated in the display
TRAC:SWE:MEAS:PULS:DISP:ANN ON
activates indication of the selected pulse data in the display

Options: Option R&S SMA-K28

Manual control: See "[Transition Times - Pulse Data Analysis](#)" on page 178

:TRACe<ch>[:POWer]:SWEep:PULSe:THReshold:BASE?

This command queries how the threshold parameters are calculated.

Note: This parameter is only available in time measurement mode and R&S NRP-Z81 power sensors.

Return values:

<Base> VOLTage | POWer

Example:

TRAC1:SWE:PULS:THR:BASE?
queries the threshold base of pulse data calculation.

Usage: Query only

Manual control: See "[Voltage / Power Related - Pulse Data Analysis](#)" on page 176

:TRACe<ch>[:POWer]:SWEep:PULSe:THReshold:POWer:HREFerence?

This command queries the upper threshold level of the overall pulse level. The distal power defines the end of the rising edge and the start of the falling edge of the pulse.

Note: This parameter is only available in time measurement mode and R&S NRP-Z81 power sensors.

Return values:

<HReference> float
Range: 0.0 to 100.0
Increment: 0.01
*RST: 90.0
Default unit: %

Example:

TRAC2:SWE:PULS:THR:POW:HREF?
queries the upper reference level of trace 2.

Usage: Query only

Manual control: See "[Distal - Pulse Data Analysis](#)" on page 177

:TRACe<ch>[:POWer]:SWEep:PULSe:THReshold:POWer:REFerence?

This command queries the medial threshold level of the overall pulse level. This level is used to define the pulse width and pulse period.

Note: This parameter is only available in time measurement mode and R&S NRP-Z81 power sensors.

Return values:

<Reference> float
 Range: 0.0 to 100.0
 Increment: 0.01
 *RST: 50.0
 Default unit: %

Example:

TRAC3 : SWE : PULS : THR : POW : REF ?
 queries the medial threshold level of trace 3.

Usage: Query only

Manual control: See "[Mesial - Pulse Data Analysis](#)" on page 177

:TRACe<ch>[:POWer]:SWEep:PULSe:THReshold:POWer:LREFerence?

This command queries the lower medial threshold level of the overall pulse level. The proximal power defines the start of the rising edge and the end of the falling edge of the pulse.

Note: This parameter is only available in time measurement mode and R&S NRP-Z81 power sensors.

Return values:

<LReference> float
 Range: 0.0 to 100.0
 Increment: 0.01
 *RST: 10.0
 Default unit: %

Example:

TRAC : SWE : PULS : THR : POW : LREF ?
 queries the medial threshold level of trace 1.

Usage: Query only

Manual control: See "[Proximal - Pulse Data Analysis](#)" on page 177

:TRACe<ch>[:POWer]:SWEep:STATe <State>

This command activates the selected trace.

Parameters:

<State>

OFF | ON | HOLD

*RST: The preset value for each trace is evaluated during runtime as follows: If a sensor is plugged into the generator whose number corresponds to the trace number, this sensor is used to feed the trace and the state of the trace is ON; If no sensor is found with a number corresponding to the trace number, the preset value of the trace is "Off".

Example:

```
TRAC2:SWE:COPY REF
stores trace2 as reference trace'
TRAC1:SWE:FEED REF
assigns the reference trace to trace 1.
TRAC1:SWE:STAT ON
assigns the reference trace to trace 1.
SENS:SWE:RMOD SING
selects single measurement
SENS:SWE:INIT
starts the measurement
```

Manual control: See ["Indication - Power Analysis"](#) on page 158

7.13 SOURce Subsystem

The SOURce subsystem contains the commands for configuring the digital and analog signals.

SOURce<hw>

For one-path instruments, the keyword SOURce is optional and can be omitted.

• SOURce:ADF Subsystem.....	449
• SOURce:AM Subsystem.....	454
• SOURce:CHIRp Subsystem.....	457
• SOURce:CORRection Subsystem.....	461
• SOURce:DME Subsystem.....	470
• SOURce:FM Subsystem.....	496
• SOURce:FREQUency Subsystem.....	500
• SOURce:ILS Subsystem.....	509
• SOURce:INPUt Subsystem.....	524
• SOURce:LFOuTput Subsystem.....	525
• SOURce:LIST Subsystem.....	537
• SOURce:MBEacon Subsystem.....	551
• SOURce:MODulation Subsystem.....	557
• SOURce:NOISe Subsystem.....	558
• SOURce:PGEN Subsystem.....	560
• SOURce:PHASe Subsystem.....	560
• SOURce:PM Subsystem.....	561

• SOURce:POWer Subsystem.....	566
• SOURce:PULM Subsystem.....	576
• SOURce:ROSCillator Subsystem.....	592
• SOURce:SWEEP Subsystem.....	595
• SOURce:VOR Subsystem.....	604

7.13.1 SOURce:ADF Subsystem

The ADF subsystem contains the commands for checking the ADF modulation. The AM-specific characteristics of the internal modulation source are defined with commands `SOURce:ADF:...`. Characteristics which are valid for all modulations and the LF Output are configured in the `SOURce:LFOutput` subsystem. The signal is output at the LF OUT connector.

<code>[SOURce]:ADF:COMid:CODE</code>	449
<code>[SOURce]:ADF:COMid:DASH</code>	450
<code>[SOURce]:ADF:COMid:DEPTH</code>	450
<code>[SOURce]:ADF:COMid:DOT</code>	451
<code>[SOURce]:ADF:COMid:FREQuency</code>	451
<code>[SOURce]:ADF:COMid:LETTer</code>	451
<code>[SOURce]:ADF:COMid:PERiod</code>	452
<code>[SOURce]:ADF:COMid:SYMBol</code>	452
<code>[SOURce]:ADF:COMid:TSCHema</code>	453
<code>[SOURce]:ADF:COMid[:STATe]</code>	453
<code>[SOURce]:ADF:STATe</code>	454

`[SOURce]:ADF:COMid:CODE <Code>`

The command enters the coding of the COM/ID signal by the international short name of the airport (e.g. MUC for the Munich airport). The COM/ID tone is sent according to the selected code (see [table 5-15](#)). If no coding is entered, the COM/ID tone is sent uncoded (key down).

The length of the morse code can be varied. For selection standard time scheme (`ADF:COM:TSCH STD`), the selected dot length determines the setting of all other length parameters of the morse code (dash length, symbol space and letter space). For selection user time scheme (`ADF:COM:TSCH USER`), all length parameters of the code can be set independently.

Parameters:

`<Code>` string

Example: `ADF:COM:CODE 'MUC'`
select COM/ID code for Munich airport.

Usage: SCPI confirmed

Options: Option R&S SMA-K25

Manual control: See "[COM/ID\(A0/A2\) Code - ADF Modulation](#)" on page 289

[[:SOURce]:ADF:COMid:DASH <Dash>

Enters the length of a morse dash by means of seconds. This command is available for user time schema only.

Parameters:

<Dash> float
 Range: 50 ms to 1 s
 Increment: 0.1
 *RST: 300 ms
 Default unit: s

Example:

```
ADF:COM:CODE 'MUC'
selects code for Munich airport
ADF:COM:TSCH USER
selects user time schema
ADF:COM:DOT 200ms
sets a dot length of 200 ms.
ADF:COM:DASH 400ms
sets a dash length of 400 ms.
ADF:COM:LETT 50ms
sets a letter space of 50 ms.
ADF:COM:SYMB 10ms
sets a symbol space of 10 ms.
```

Options: Option R&S SMA-K25

Manual control: See "["COM/ID\(A0/A2\) Dash Length - ADF Modulation"](#)" on page 290

[[:SOURce]:ADF:COMid:DEPTh <Depth>

The command sets the frequency of the communication/identification signal.

Parameters:

<Depth> float
 Range: 0 to 100
 Increment: 0.1
 *RST: 95
 Default unit: PCT

Example:

```
ADF:COM:DEPT 10 PCT
sets the AM depth of the communication/identification signal to the
value of 10 PCT.
```

Options: Option R&S SMA-K25

Manual control: See "["COM/ID\(A0/A2\) Depth - ADF Modulation"](#)" on page 290

[[:SOURce]:ADF:COMid:DOT <Dot>

Enters the length of a morse dot by means of seconds. The length of the dash (3xdot), symbol space (=dot) and letter space (=3xdot) is also determined by this entry.

Parameters:

<Dot> <length>
 Range: 50 ms to 1 s
 Increment: 0.1 ms
 *RST: 100 ms
 Default unit: s

Example: ADF:COM:CODE 'MUC '
 selects code for Munich airport
 ADF:COM:DOT 200ms
 sets a dot length of 200 ms.

Example: ADF:COM:CODE 'MUC '
 selects code for Munich airport
 ADF:COM:DOT 200ms
 sets a dot length of 200 ms.

Options: Option R&S SMA-K25

Manual control: See "[COM/ID\(A0/A2\) Dot Length - ADF Modulation](#)"
 on page 290

[[:SOURce]:ADF:COMid:FREQuency <Frequency>

The command sets the frequency of the additional communication/identification signal.

Parameters:

<Frequency> float
 Range: 0.1 to 20000
 Increment: 0.1
 *RST: 1020
 Default unit: Hz

Example: ADF:COM:FREQ 1020
 sets the frequency of the identification signal to the standard value
 of 1020Hz.

Options: Option R&S SMA-K25

Manual control: See "[COM/ID\(A0/A2\) Frequency - ADF Modulation](#)"
 on page 290

[[:SOURce]:ADF:COMid:LETTer <Letter>

Enters the length of a letter space by means of seconds. This command is available user time schema only.

Parameters:

<Letter> <length>
 Range: 50 ms to 1s
 Increment: 0.1 ms
 *RST: 300 ms
 Default unit: s

Example:

```
ADF:COM:CODE 'MUC'
selects code for Munich airport
ADF:COM:TSCH USER
selects user time schema
ADF:COM:DOT 200ms
sets a dot length of 200 ms.
ADF:COM:DASH 400ms
sets a dash length of 400 ms.
ADF:COM:LETT 50ms
sets a letter space of 50 ms.
ADF:COM:SYMB 10ms
sets a symbol space of 10 ms.
```

Options: Option R&S SMA-K25

Manual control: See "[COM/ID\(A0/A2\) Letter Space - ADF Modulation](#)"
 on page 291

[:SOURce]:ADF:COMid:PERiod <Period>

Enters the period of the COM/ID signal in seconds.

Parameters:

<Period> float
 Range: 0 ms to 120 s
 Increment: 1 ms
 *RST: 9 s

Example: ADF:COM:PER 22s
 sets a period of 22 s for the COM/ID signal.

Options: Option R&S SMA-K25

Manual control: See "[COM/ID\(A0/A2\) Period - ADF Modulation](#)" on page 290

[:SOURce]:ADF:COMid:SYMBol <Symbol>

Enters the length of the symbol space by means of seconds. This command is available for user time schema only.

Parameters:

<Symbol> <length>
 Range: 50 ms to 1 s
 Increment: 0.1 ms
 *RST: 100 ms
 Default unit: s

Example:

```
ADF:COM:CODE 'MUC'
selects code for Munich airport
ADF:COM:TSCH USER
selects user time schema
ADF:COM:DOT 200ms
sets a dot length of 200 ms.
ADF:COM:DASH 400ms
sets a dash length of 400 ms.
ADF:COM:LETT 50ms
sets a letter space of 50 ms.
ADF:COM:SYMB 10ms
sets a symbol space of 10 ms.
```

Options: Option R&S SMA-K25

Manual control: See "[COM/ID\(A0/A2\) Symbol Space - ADF Modulation](#)" on page 291

[[:SOURce]:ADF:COMid:TSCHema <TSchema>

Selects if the set dot length determines the dash length (= three times the dot length) (setting STD) or if all length parameters can be set independently (setting USER). (COM/ID signal).

Parameters:

<TSchema> STD | USER
 *RST: STD

Example:

```
ADF:COM:CODE 'MUC'
selects code for Munich airport
ADF:COM:TSCH STD
selects standard time schema
ADF:COM:DOT 200ms
sets a dot length of 200 ms. The dash length and letter space is 3
x dot length, the symbol space equals the dot length.
```

Options: Option R&S SMA-K25

Manual control: See "[COM/ID\(A0/A2\) Time Schema - ADF Modulation](#)" on page 290

[[:SOURce]:ADF:COMid[:STATe] <State>

The command activates or deactivates the additional communication/identification signal.

Parameters:

<State> 0 | 1 | OFF | ON
 *RST: OFF

Example:

ADF:COM ON
 activates the COM/ID signal.

Options:

Option R&S SMA-K25

Manual control:

See "[COM/ID\(A0/A2\) State - ADF Modulation](#)" on page 288

[[:SOURce]:ADF:STATe <State>

The command switches on or off the ADF modulation.

Parameters:

<State> 0 | 1 | OFF | ON
 *RST: OFF

Example:

ADF ON
 activates the ADF signal. The RF-frequency is automatically set to 190 kHz.

Manual control:

See "[State - ADF Modulation](#)" on page 288

7.13.2 SOURce:AM Subsystem

The AM-specific characteristics of the internal modulation source are defined with commands `SOURce:AM:INTernal:.`. The external signal is input at the AM EXT connector.

The settings for the internal modulation source (LF generator) are made in the `SOURce:LFOutput` subsystem.

[:SOURce<hw>]:AM[:DEPTh].....	454
[:SOURce<hw>]:AM:EXTernal:COUPling.....	455
[:SOURce<hw>]:AM:INTernal<ch>:DEPTh.....	455
[:SOURce<hw>]:AM:INTernal:SOURce.....	455
[:SOURce<hw>]:AM:SENSitivity?.....	456
[:SOURce<hw>]:AM:SOURce.....	456
[:SOURce<hw>]:AM:STATe.....	457

[[:SOURce<hw>]:AM[:DEPTh] <Depth>

The command sets the modulation depth of the amplitude modulation in percent. The modulation depth is limited by the maximum peak envelope power (PEP).

Parameters:

<Depth> float
 Range: 0 to 100
 Increment: See data sheet
 *RST: 30
 Default unit: PCT

Example: `AM 15PCT`
sets the AM modulation depth to 15 percent

Manual control: See "[AM Depth](#)" on page 216

[:SOURce<hw>]:AM:EXTernal:COUPling <Coupling>

The command selects the coupling mode for the external modulation input in the case of amplitude modulation.

Parameters:

<Coupling> AC | DC

AC

The DC voltage component is disconnected from the modulation signal.

DC

The modulation signal is not changed.

*RST: AC

Example: `AM:EXT:COUP AC`
Selects the coupling mode AC for external amplitude modulation.

Usage: SCPI confirmed

Manual control: See "[AM External Coupling](#)" on page 218

[:SOURce<hw>]:AM:INTernal<ch>:DEPTH <Depth>

Sets the modulation depth of the two LF generators. The sum of the two values must not exceed the overall modulation depth set in the upper part of the menu.

Parameters:

<Depth> float

Range: 0 to 100 PCT

Increment: See data sheet

*RST: 30

Example: `AM:INT2 15PCT`
sets the AM modulation depth to 15 percent for the second LF generator. With setting 30 percent for the overall modulation depth, the modulation depth of the first LF generator is automatically set to 15 percent, also.

Options: R&S SMA-K24

Manual control: See "[Depth 1/Depth 2](#)" on page 217

[:SOURce<hw>]:AM:INTernal:SOURce <Source>

Selects which internal modulation source is used. The available selection depends on the installed options. You can configure the selected source with the commands in the `SOURce:LFOutput` subsystem.

Parameters:

<Source> LF1 | LF2 | LF12 | NOISe | LF1Noise | LF2Noise
 *RST: LF1

Example:

AM:INT:SOUR LF1
 selects LF generator 1 as internal modulation source.

Options:

Option R&S SMA-K24 for selections other than LF1

Manual control:

See "[Internal Source](#)" on page 216

[:SOURce<hw>]:AM:SENSitivity?

The command queries the input sensitivity of the external modulation input in %/V. The command is only effective if the external modulation source is selected (SOUR:AM:SOUR EXT). The returned value depends on the modulation depth setting (SOUR:AM:DEPT_h). This value is assigned to the voltage value for full modulation of the input.

Return values:

<Sensitivity> float

Example:

AM:DEPT 50
 sets a modulation depth of 50 %.
 AM:SENS?
 queries the input sensitivity at the external modulation input.
 Response: 50
 since the voltage value for full modulation is 1V, the resulting sensitivity is precisely 50%/V.

Usage:

Query only
 SCPI confirmed

Manual control:

See "[AM Sensitivity](#)" on page 217

[:SOURce<hw>]:AM:SOURce <Source>

The command selects the modulation source for amplitude modulation.

Internal and external modulation source can be selected at the same time.

Parameters:

<Source> INTernal | EXTernal

INT

INT is the internal modulation source which is selected with command AM:SOURce:INTernal and configured in the SOURce:LFOutput subsystem.

EXT

The external signal is input at the AM EXT connector.

*RST: INTernal

Example: AM: SOUR INT
selects the internal modulation source.
AM: INT: SOUR LF12
selects the LF generator 1 and 2 as internal modulation sources.

Manual control: See "AM Source" on page 216

[:SOURce<hw>]:AM:STATe <State>

The command activates/deactivates amplitude modulation.

Parameters:

<State> 0 | 1 | OFF | ON

Example: AM: STAT ON
activates AM modulation.

Usage: SCPI confirmed

Manual control: See "State" on page 216

7.13.3 SOURce:CHIRp Subsystem

The SOURce:CHIRp subsystem contains the commands for setting the modulation chirp.

The modulation chirp is optional and requires an interface board with part number 1400.0530.02 or 1400.0552.02. The hardware data is queried with command
DIAG:BGIN? "SMA_IF".

The keyword SOURce is optional with commands and can be omitted.

[:SOURce<hw>]:CHIRp:BANDwidth	457
[:SOURce<hw>]:CHIRp:COMPression:RATio?	458
[:SOURce<hw>]:CHIRp:DIRection	458
[:SOURce<hw>]:CHIRp:PULSe:PERiod	459
[:SOURce<hw>]:CHIRp:PULSe:WIDTh	459
[:SOURce<hw>]:CHIRp:STATe	459
[:SOURce<hw>]:CHIRp:TRIGger:EXTernal:GATE:POLarity	460
[:SOURce<hw>]:CHIRp:TRIGger:EXTernal:IMPedance	460
[:SOURce<hw>]:CHIRp:TRIGger:EXTernal:SLOPe	460
[:SOURce<hw>]:CHIRp:TRIGger:MODE	461

[:SOURce<hw>]:CHIRp:BANDwidth <Bandwidth>

The command sets the modulation bandwidth of the modulation chirp in Hz. The maximal bandwidth depends on the RF frequency set and the selected modulation mode (see data sheet).

Parameters:

<Bandwidth> float
 Range: 0 Hz to 80 MHz
 Increment: See data sheet
 *RST: 1 kHz
 Default unit: Hz

Example:

CHIR:BAND 5E3
 sets the modulation bandwidth to 5 kHz.

Options:

R&S SMA-B20/22 and interface board 1400.0530.02 or
 1400.0552.02

Manual control:

See "[Bandwidth - Chirp Modulation](#)" on page 234

[:SOURce<hw>]:CHIRp:COMPression:RATio?

The command queries the pulse compression ratio, i.e. the product of pulse width (s) and bandwidth (Hz). Pulse compression increases the range resolution as well as the signal to noise ratio of pulsed signals.

Return values:

<Ratio> float
 Increment: 0.01

Example:

CHIR:COMP:RAT?
 'queries the compression ratio.

Usage:

Query only

Options:

R&S SMA-B20/22 and interface board 1400.0530.02 or
 1400.0552.02

Manual control:

See "[Compression Ratio - Chirp Modulation](#)" on page 235

[:SOURce<hw>]:CHIRp:DIRection <Direction>

Selects the direction of the chirp modulation.

Parameters:

<Direction> DOWN | UP
UP
 The chirp starts with the lower frequency.
DOWN
 The chirp starts with the higher frequency.
 *RST: UP

Example:

SOUR:CHIR:DIR UP

Manual control:

See "[Direction - Chirp Modulation](#)" on page 234

[:SOURce<hw>]:CHIRp:PULSe:PERiod <Period>

The command sets the period of the generated modulation chirp. The period determines the repetition frequency of the internal signal.

Parameters:

<Period> 5µs .. 100s | 20ns .. 100 s
 Increment: 1us | 20 ns
 *RST: 1 ms
 Default unit: s

Example: CHIR:PULS:PER 420 ns
 the chirp period is 420 ns.

Options: R&S SMA-B20/22 and interface board 1400.0530.02 or 1400.0552.02; The enhanced features require option R&S SMA-K23

Manual control: See "[Pulse Period - Chirp Modulation](#)" on page 235

[:SOURce<hw>]:CHIRp:PULSe:WIDTh <Width>

The command sets the width of the generated pulse. The pulse width must be at least 1us less than the set pulse period.

Parameters:

<Width> float
 Range: 100 ns to 100 s
 Increment: 100 ns
 *RST: 1000 ns
 Default unit: s

Example: CHIR:PULS:WIDT 330 ns
 sets a width of 330 ns for the pulse.

Options: R&S SMA-B20/22 and interface board 1400.0530.02 or 1400.0552.02; The enhanced features require option R&S SMA-K23

Manual control: See "[Pulse Width - Chirp Modulation](#)" on page 235

[:SOURce<hw>]:CHIRp:STATe <State>

The command activates/deactivates the generation of modulation chirps.

Parameters:

<State> 0 | 1 | OFF | ON
 *RST: OFF

Example: CHIR:STAT ON
 activates generation of modulation chirps.

Options: R&S SMA-B20/22 and interface board 1400.0530.02 or 1400.0552.02

Manual control: See ["State - Chirp Modulation"](#) on page 233

[:SOURce<hw>]:CHIRp:TRIGger:EXTernal:GATE:POLarity <Polarity>

(External Gate only).

The command selects the active level of the gate signal.

Parameters:

<Polarity> NORMal | INVerted

NORMal

The chirp modulation signals are generated while the gate signal is high.

INVerted

The chirp modulation signals are generated while the gate signal is low.

*RST: NORMal

Example: CHIR:TRIG:EXT:GATE:POL NORM
selects gate polarity normal.

Options: R&S SMA-B20/22 and interface board 1400.0530.02 or
1400.0552.02

Manual control: See ["Gate Input Polarity - Chirp Modulation"](#) on page 235

[:SOURce<hw>]:CHIRp:TRIGger:EXTernal:IMPedance <Impedance>

The commands set the impedance for external feed via the PULSE EXT input.

Parameters:

<Impedance> G10k | G50

G10k

10 kOhm to ground

G50

50 ohm to ground

*RST: G50

Example: CHIR:TRIG:EXT:IMP G10K
the PULSE EXT input is set to 10 kOhm to ground.

Options: R&S SMA-B20/22 and interface board 1400.0530.02 or
1400.0552.02

Manual control: See ["External Impedance - Chirp Modulation"](#) on page 236

[:SOURce<hw>]:CHIRp:TRIGger:EXTernal:SLOPe <Slope>

The command sets the active slope of an externally applied trigger signal.

The signal is supplied via the PULSE EXT connector.

Parameters:

<Slope> NEGative | POSitive
 *RST: POSitive

Example:

CHIR:TRIG:EXT:SLOP
 the active slope of the external trigger signal is the falling slope.

Options:

R&S SMA-B20/22 and interface board 1400.0530.02 or
 1400.0552.02

Manual control:

See "[External Trigger Input Slope - Chirp Modulation](#)"
 on page 235

[:SOURce<hw>]:CHIRp:TRIGger:MODE <Mode>

The command selects the trigger mode for modulation chirp.

Note: External trigger signals are supplied via the PULSE EXT connector.

Parameters:

<Mode> AUTO | EXTernal | EGATe
AUTO
 The modulation chirp is generated continuously.
EXTernal
 The modulation chirp is triggered by an external trigger event.
EGATe
 The modulation chirp is gated by an external gate signal.
 *RST: AUTO

Example:

CHIR:TRIG:EXT:MODE EXT
 selects triggering by an external trigger event.

Options:

R&S SMA-B20/22 and interface board 1400.0530.02 or
 1400.0552.02

Manual control:

See "[Trigger Mode - Chirp Modulation](#)" on page 235

7.13.4 SOURce:CORRection Subsystem

The output level is corrected in the CORRection subsystem. Correction is performed by user-defined table values being added to the output level for the respective RF frequency. In the R&S SMA, this subsystem is used to select, transfer and activate user correction tables.

Each list is stored as a file. The name of the user correction file can be freely selected. The file extension *.uco is assigned automatically and cannot be changed.

The files can be stored in a freely selectable directory and opened from there. The default directory is set using command :MMEMory:CDIRectory on page 383. In the case of files which are stored in the default directory, only the file name has to be specified in commands. Otherwise, the complete absolute path has to be specified with every command. The extension can be omitted in any case.



In the following command examples, the files are stored in the default directory.

The amplitude can also be linearized automatically by means of a R&S NRP power sensor connected to the generator output signal. With the aid of the command `[:SOURce<hw>]:CORRection:CSET:DATA[:SENSor<ch>][:POWER]:SONCe`, a list with correction values for external test assemblies can be automatically determined, e.g. for compensating the frequency response of cables. The correction values can be acquired any time irrespective of the modulation settings of the generator.

<code>[:SOURce]:CORRection:CSET:CATalog?</code>	462
<code>[:SOURce<hw>]:CORRection:CSET:DATA:FREQUency</code>	463
<code>[:SOURce<hw>]:CORRection:CSET:DATA:FREQUency:POINts?</code>	463
<code>[:SOURce<hw>]:CORRection:CSET:DATA:POWer</code>	463
<code>[:SOURce<hw>]:CORRection:CSET:DATA:POWer:POINts?</code>	464
<code>[:SOURce<hw>]:CORRection:CSET:DATA[:SENSor<ch>][:POWER]:SONCe</code>	464
<code>[:SOURce]:CORRection:CSET:DELete</code>	464
<code>[:SOURce<hw>]:CORRection:DEXChange:AFILe:CATalog?</code>	465
<code>[:SOURce<hw>]:CORRection:DEXChange:AFILe:EXTension</code>	465
<code>[:SOURce<hw>]:CORRection:DEXChange:AFILe:SELect</code>	466
<code>[:SOURce<hw>]:CORRection:DEXChange:AFILe:SEParator:COLumn</code>	466
<code>[:SOURce<hw>]:CORRection:DEXChange:AFILe:SEParator:DECimal</code>	467
<code>[:SOURce<hw>]:CORRection:DEXChange:EXECute</code>	467
<code>[:SOURce<hw>]:CORRection:DEXChange:MODE</code>	468
<code>[:SOURce<hw>]:CORRection:DEXChange:SELect</code>	468
<code>[:SOURce<hw>]:CORRection:CSET[:SELect]</code>	469
<code>[:SOURce<hw>]:CORRection[:STATe]</code>	469
<code>[:SOURce<hw>]:CORRection:VALue?</code>	470

`[:SOURce]:CORRection:CSET:CATalog?`

The command requests a list of user correction tables. The individual lists are separated by commas.

The lists are stored with the fixed file extensions `*.ucor` in a directory of the user's choice. The directory applicable to the commands is defined with the command

```
MMEMoRY:CDIR.
```

Return values:

<Catalog> string

Example:

```
MMEMoRY:CDIR '/var//Lists/ucor'
```

selects the directory for the user correction files.

```
CORR:CSET:CAT?
```

queries which correction tables are available.

```
Response:UCOR1,UCOR2,UCOR3
```

the correction tables UCOR1, UCOR2 and UCOR3 are available.

Usage:

Query only

[[:SOURce<hw>]:CORRection:CSET:DATA:FREQuency <Frequency>

The command transfers the frequency data to the table selected with :CORRection:CSET:SELEct.

The numerical suffix at SOURce must not be used for this command.

Parameters:

<Frequency> Frequency#1[, Frequency#2, ...]
 Range: 300 kHz to RFmax (depending on model)
 Default unit: Hz

Example:

CORR:CSET '/var//Lists/ucor/ucor1'
 selects the table ucor1.
 CORR:CSET:DATA:FREQ 100MHz,102MHz,103MHz,...
 enters the frequency value in the table ucor1.

Manual control: See ["Edit User Cor. Data - User Correction"](#) on page 139

[[:SOURce<hw>]:CORRection:CSET:DATA:FREQuency:POINts?

The command queries the number of frequency values in the selected table.

The numerical suffix at SOURce must not be used for this command.

Return values:

<Points> float

Example:

CORR:CSET '/var//Lists/ucor/ucor1'
 selects the table ucor1.
 CORR:CSET:DATA:FREQ:POIN?
 queries the number of frequency values in the table ucor1.
 Response: 440
 the table ucor1 contains 440 frequency values.

Usage: Query only

[[:SOURce<hw>]:CORRection:CSET:DATA:POWEr <Power>

The command transfers the level data to the table selected with :CORRection:CSET:SELEct.

*RST does not affect data lists. The numerical suffix at SOURce must not be used for this command.

Parameters:

<Power> Power#1[, Power#2, ...]
 Range: -40 dB to 6 dB
 Default unit: dB

Example: `CORR:CSET '/var//Lists/ucor/ucor1'`
selects the table `ucor1`.
`CORR:CSET:DATA:POW 1dB, 0.8dB, 0.75dB, ...`
enters the level values in the table `ucor1`.

Manual control: See ["Edit User Cor. Data - User Correction"](#) on page 139

[[:SOURce<hw>]:CORRection:CSET:DATA:POWER:POINTs?

The command queries the number of level values in the selected table.

The numerical suffix at SOURce must not be used for this command.

Return values:

<Points> float

Example: `CORR:CSET '/var//Lists/ucor/ucor1'`
selects the table `ucor1`.
`CORR:CSET:DATA:POW:POIN?`
queries the number of level values in the table `ucor1`.
Response: 440
the table `ucor1` contains 440 level values.

Usage: Query only

[[:SOURce<hw>]:CORRection:CSET:DATA[:SENSor<ch>]][:POWER]:SONCe

The command fills the selected user correction list with the level values measured by the power sensor for the given frequencies.

The power sensor used is selected by the suffix in key word `SENSe` of the command header.

Suffix:

<ch> 1 .. 3
Suffix 1 denotes the sensor connected to the SENSOR connector, suffix 2 the sensor connected first to one of the USB interfaces and suffix 3 the sensor connected second to one of the USB interfaces.

Example: `CORR:CSET:DATA:SENS:POW:SONC`
fills the user correction list with level values acquired by the power sensor connector to the SENSOR connector.

Usage: Event

Manual control: See ["Fill User Correction Data with Sensor"](#) on page 144

[[:SOURce]:CORRection:CSET:DELeTe <Delete>

The command deletes the specified table.

The lists are stored with the fixed file extensions `*.uco` in a directory of the user's choice. The directory applicable to the commands is defined with the command `MMEMoRY:CDIR`. A path can also be specified in command `:SOUR:CORR:CSET:CAT?`, in which case the file in the specified directory is deleted.

The numerical suffix under SOURce is irrelevant.

Setting parameters:

<Delete> <table name>

Example: `MMEM:CDIR '/var//Lists/ucor'`
selects the directory for the user correction files.
`CORR:CSET:DEL 'UCOR1'`
deletes the table `ucor1`.

Usage: Event

Manual control: See ["User Cor. Data - User Correction"](#) on page 139

[:SOURce<hw>]:CORRection:DEXChange:AFILe:CATalog?

The command requests a list of available ASCII files for export/import of user correction data. The individual files are separated by commas.

The ASCII files are stored with the fixed file extensions `*.txt` or `*.csv` in a directory of the user's choice. The directory applicable to the commands is defined with the command `MMEMoRY:CDIR`.

Return values:

<Catalog> string

Example: `MMEM:CDIR '/var//lists/ucor/import'`
selects the directory for the ASCII files with frequency and level value pairs.
`CORR:DEXC:AFIL:EXT TXT`
selects that ASCII files with extension `*.txt` are listed.
`CORR:DEXC:AFIL:CAT?`
queries the available files with extension `*.txt`.
Response: `'ucor1,ucor2'`
the ASCII files `ucor1.txt` and `ucor2.txt` are available.

Usage: Query only

[:SOURce<hw>]:CORRection:DEXChange:AFILe:EXTension <Extension>

The command selects the file extension of the ASCII file to be imported or exported. Selection TXT (text file) or CSV (Excel file) is available.

Parameters:

<Extension> TXT | CSV
*RST: TXT

Example: `MMEM:CDIR '/var//lists/ucor/import'`
 selects the directory for the ASCII files with frequency and level value pairs.
`CORR:DEXC:AFIL:EXT TXT`
 selects that ASCII files with extension *.txt are listed.
`CORR:DEXC:AFIL:CAT?`
 queries the available files with extension *.txt.
 Response: 'list1,list2'
 the ASCII files ucor1.txt and ucor2.txt are available.

Manual control: See ["Extension - User Correction"](#) on page 141

[:SOURce<hw>]:CORRection:DEXChange:AFILe:SElect <Select>

The command selects the ASCII file to be imported or exported.

The ASCII files are stored with the fixed file extensions *.txt or *.csv in a directory of the user's choice. The directory applicable to the commands is defined with the command `MMEMory:CDIR`. A path can also be specified in command `SOUR:CORR:DEXC:AFIL:SEL`, in which case the files are stored or loaded in the specified directory.

Parameters:

<Select> <ascii file name>

Example:

`CORR:DEXC:MODE IMP`
 selects that ASCII files with frequency and level value pairs are imported and transferred into user correction lists.
`CORR:DEXC:AFIL:SEL`
`'/var//user/ucor/import/ucor.csv'`
 selects that ASCII file ucor.csv is imported.
`CORR:DEXC:SEL '/var//user/ucor/import/ucor_imp'`
 selects that the ASCII file ucor.csv is imported into user correction list ucor_imp.

Manual control: See ["Select ASCII Source / Destination - User Correction"](#) on page 142

[:SOURce<hw>]:CORRection:DEXChange:AFILe:SEParator:COLumn <Column>

The command selects the separator between the frequency and level column of the ASCII table.

Parameters:

<Column> TABulator | SEMicolon | COMMa | SPACe
 *RST: SEMicolon|

Example:

```
CORR:DEXC:MODE EXP
selects that the user correction list is exported into an ASCII file.
CORR:DEXC:AFIL:SEL
'/var//user/ucor/import/ucor.csv'
selects ASCII file ucor.csv as destination for the user correction
list data.
CORR:DEXC:AFIL:SEP:COL TAB
the pairs of frequency and level values are separated by a tabu-
lator.
CORR:DEXC:AFIL:SEP:DEC DOT
selects the decimal separator dot.
CORR:DEXC:SEL '/var//user/ucor/import/ucor_imp'
selects that the user correction list ucor_imp is imported into ASCII
file ucor.csv.
```

Manual control: See ["Column Separator- User Correction"](#) on page 142

[:SOURce<hw>]:CORRection:DEXChange:AFILe:SEParator:DECimal <Decimal>

The command the decimal separator used in the ASCII data between '.' (decimal point) and ',' (comma) with floating-point numerals.

Parameters:

<Decimal> DOT | COMMa
*RST: DOT

Example:

```
CORR:DEXC:MODE EXP
selects that the user correction list is exported into an ASCII file.
CORR:DEXC:AFIL:SEL
'/var//user/ucor/import/ucor.csv'
selects ASCII file ucor.csv as destination for the user correction
list data.
CORR:DEXC:AFIL:SEP:COL TAB
the pairs of frequency and level values are separated by a tabu-
lator.
CORR:DEXC:AFIL:SEP:DEC DOT
selects the decimal separator dot.
CORR:DEXC:SEL '/var//user/ucor/import/ucor_imp'
selects that the user correction list ucor_imp is imported into ASCII
file ucor.csv.
```

Manual control: See ["Decimal Point - User Correction"](#) on page 142

[:SOURce<hw>]:CORRection:DEXChange:EXECute

The command starts the export or import of the selected file. When import is selected, the ASCII file is imported as user correction list. When export is selected, the user correction list is exported into the selected ASCII file.

- Example:** `CORR:DEXC:MODE IMP`
 selects that ASCII files with frequency and level value pairs are imported and transferred into user correction lists.
`CORR:DEXC:AFIL:SEL`
`'/var//user/ucor/import/ucor.csv'`
 selects that ASCII file ucor.csv is imported.
`CORR:DEXC:SEL '/var//user/ucor/import/ucor_imp'`
 selects that the ASCII file ucor.csv is imported into user correction list ucor_imp.
`CORR:DEXC:EXEC`
 starts the import of the ASCII file data into the user correction file.
- Usage:** Event
- Manual control:** See ["Import / Export - User Correction"](#) on page 142

[:SOURce<hw>]:CORRection:DEXChange:MODE <Mode>

The command selects if user correction lists should be imported or exported. Depending on the selection her, the file select command define either the source or the destination for user correction lists and ASCII files.

Parameters:

<Mode> IMPort | EXPort
 *RST: IMPort

- Example:** `CORR:DEXC:MODE IMP`
 selects that ASCII files with frequency and level value pairs are imported and transferred into user correction lists.
`CORR:DEXC:AFIL:SEL`
`'/var//user/ucor/import/ucor.csv'`
 selects that ASCII file ucor.csv is imported.
`CORR:DEXC:SEL '/var//user/ucor/import/ucor_imp'`
 selects that the ASCII file ucor.csv is imported into user correction list ucor_imp.

Manual control: See ["Mode - User Correction"](#) on page 141

[:SOURce<hw>]:CORRection:DEXChange:SELEct <Select>

The command selects the user correction list to be imported or exported.

The user correction files are stored with the fixed file extensions *.uco in a directory of the user's choice. The directory applicable to the commands is defined with the command `MMEMory:CDIR`. A path can also be specified in command `SOUR:CORR:DEXC:SEL`, in which case the files are stored or loaded in the specified directory.

Parameters:

<Select> <list name>

Example: `CORR:DEXC:MODE IMP`
 selects that ASCII files with frequency and level value pairs are imported and transferred into user correction lists.
`CORR:DEXC:AFIL:SEL`
`'/var//user/ucor/import/ucor.csv'`
 selects that ASCII file `ucor.csv` is imported.
`CORR:DEXC:SEL '/var//user/ucor/import/ucor_imp'`
 selects that the ASCII file `ucor.csv` is imported into user correction list `ucor_imp`.

Manual control: See "[Destination / Source - User Correction](#)" on page 142

[:SOURce<hw>]:CORRection:CSET[:SELe] <Select>

The command selects the table for user correction. Level correction must also be activated with the command `SOURce<hw>:CORRection:CSET:STATE ON`.

The lists are stored with the fixed file extensions `*.uco` in a directory of the user's choice. The directory applicable to the commands is defined with the command `MMEMory:CDIR`. A path can also be specified in command `:SOUR:CORR:CSET:SEL`, in which case the files in the specified directory are selected.

Parameters:

<Select> <table name>

Example: `CORR:CSET '/var//Lists/ucor/ucor1'`
 selects the table `ucor1`.
`CORR ON`
 activates level correction. Correction is performed using the table `ucor1`.

Usage: Event

Manual control: See "[User Cor. Data - User Correction](#)" on page 139

[:SOURce<hw>]:CORRection[:STATe] <State>

The command activates/deactivates level correction. Level correction is performed using the table which has been selected with the command `CORRection:CSET:SELe`.

Parameters:

<State> 0 | 1 | OFF | ON
 *RST: OFF

Example: `SOUR:CORR:CSET '/var//lists/ucor/ucor1'`
 selects the table `ucor1`.
`SOUR:CORR ON`
 activates user correction.

Manual control: See "[State - User Correction](#)" on page 139

[[:SOURce<hw>]:CORRection:VALue?

The command requests the current value for user correction.

Return values:

<Value> float

Example:

CORR:VAL?

queries the value currently used for level correction.

Response: -3

the correction value is - 3 dB.

Usage:

Query only

Manual control:

See "[User Correction Value - User Correction](#)" on page 139

7.13.5 SOURce:DME Subsystem

The DME subsystem contains the commands for checking the DME modulation. The characteristics of the internal modulation source are defined with commands

SOURce:DME: . . . The modulation signal can be output at the LF connector.

The keyword SOURce is optional with commands and can be omitted.

[[:SOURce]:DME:ANALysis:EFFiciency?.....	471
[[:SOURce]:DME:ANALysis:EFFiciency:OK?.....	472
[[:SOURce]:DME:ANALysis:EFFiciency:STATe.....	472
[[:SOURce]:DME:ANALysis:GATE:COUNT.....	472
[[:SOURce]:DME:ANALysis:GATE:EDELay.....	473
[[:SOURce]:DME:ANALysis:GATE[:LENGth].....	473
[[:SOURce]:DME:ANALysis:NORMalize?.....	474
[[:SOURce]:DME:ANALysis:POWER?.....	474
[[:SOURce]:DME:ANALysis:POWER:OK?.....	475
[[:SOURce]:DME:ANALysis:POWER:STATe.....	475
[[:SOURce]:DME:ANALysis:PRRate?.....	475
[[:SOURce]:DME:ANALysis:PRRate:OK?.....	476
[[:SOURce]:DME:ANALysis:PRRate:STATe.....	476
[[:SOURce]:DME:ANALysis:STATe.....	477
[[:SOURce]:DME:ANALysis:TIME?.....	477
[[:SOURce]:DME:ANALysis:TIME:OK?.....	478
[[:SOURce]:DME:ANALysis:TIME:STATe.....	478
[[:SOURce]:DME:ANALysis:TRIGger:SEARCh?.....	478
[[:SOURce]:DME:CSUffix.....	479
[[:SOURce]:DME:ICAO:CHANnel.....	479
[[:SOURce]:DME:EFFiciency.....	480
[[:SOURce]:DME:FALL.....	481
[[:SOURce]:DME:ID:CODE.....	481
[[:SOURce]:DME:ID:DASH.....	481
[[:SOURce]:DME:ID:DOT.....	482
[[:SOURce]:DME:ID:LETTer.....	483
[[:SOURce]:DME:ID:PERiod.....	483
[[:SOURce]:DME:ID:PRESet.....	484

<code>[:SOURce]:DME:ID:RATE</code>	484
<code>[:SOURce]:DME:ID[:STATe]</code>	484
<code>[:SOURce]:DME:ID:SYMBOL</code>	485
<code>[:SOURce]:DME:ID:TSCHEMA</code>	485
<code>[:SOURce]:DME:LOWemission</code>	486
<code>[:SOURce]:DME:MODE</code>	486
<code>[:SOURce]:DME:PPS</code>	487
<code>[:SOURce]:DME:PRESet</code>	487
<code>[:SOURce]:DME:RATE</code>	487
<code>[:SOURce]:DME:RDISTance</code>	488
<code>[:SOURce]:DME:RISE</code>	488
<code>[:SOURce]:DME:SHAPE</code>	489
<code>[:SOURce]:DME:SINGLE</code>	489
<code>[:SOURce]:DME:SQUitter</code>	489
<code>[:SOURce]:DME:STATe</code>	490
<code>[:SOURce]:DME:TACan:DEPTH</code>	490
<code>[:SOURce]:DME:TACan:INTernal<ch>:DEPTH</code>	491
<code>[:SOURce]:DME:TACan:PHASe</code>	491
<code>[:SOURce]:DME:TACan<ch>:FREQuency</code>	491
<code>[:SOURce]:DME:TACan:STATe</code>	492
<code>[:SOURce]:DME:TRIGger</code>	492
<code>[:SOURce]:DME:TRIGger:DELay</code>	493
<code>[:SOURce]:DME:TRIGger:DELay:NORMalize?</code>	494
<code>[:SOURce]:DME:TRIGger:GPOLarity</code>	494
<code>[:SOURce]:DME:TRIGger:IMPedance</code>	494
<code>[:SOURce]:DME:TRIGger:SLOPe</code>	495
<code>[:SOURce]:DME:WIDTh</code>	495

`[:SOURce]:DME:ANALysis:EFFiciency?`

The command queries the measured reply efficiency in percent. The measurement is the ratio of the number of measured valid reply pulse pairs to transmitted pulse pairs in a measurement cycle.

Return values:

<Efficiency> float
 Range: 0 to 100
 Increment: 0.1
 *RST: 100

Example: `DME:ANAL:EFF:STAT ON`
 activates the reply efficiency measurement
 `DME:ANAL:EFF?`
 queries the measurement result

Usage: Query only

Options: Option R&S SMA-K26

Manual control: See "[Reply Efficiency - DME Modulation](#)" on page 255

[:SOURce]:DME:ANALysis:EFFiciency:OK?

The command queries if there are valid measurement values available in the set measurement window.

Return values:

<Ok> 0 | 1 | OFF | ON
*RST: 1

Example:

DME:ANAL:EFF:STAT ON
activates the reply efficiency measurement
DME:ANAL:EFF:OK?
queries if valid measurement values are available
Response: 1
there are valid measurement values
DME:ANAL:EFF?
queries the measurement result

Usage: Query only

Options: Option R&S SMA-K26

Manual control: See "[Reply Efficiency - DME Modulation](#)" on page 255

[:SOURce]:DME:ANALysis:EFFiciency:STATe <State>

The command activates the measurement of the reply efficiency of all valid pulse pairs in a measurement cycle.

Parameters:

<State> 0 | 1 | OFF | ON
*RST: ON

Example:

DME:ANAL:EFF:STAT ON
activates the reply efficiency measurement
DME:ANAL:EFF?
queries the measurement result

Options: Option R&S SMA-K26

Manual control: See "[Reply Efficiency State- DME Modulation](#)" on page 255

[:SOURce]:DME:ANALysis:GATE:COUNT <Count>

The command sets the number of pulse pairs which are sent from the R&S SMA (= interrogator) to the ground station in one measurement cycle. Only reply pulses for which the 50% voltage point of the rising edge of the first pulse is within the measurement window are used to evaluate the delay time and reply efficiency.

Parameters:

<Count> integer
 Range: 1 to 10000
 Increment: 1
 *RST: 100

Example:

DME:ANAL:GATE:COUN 100
 sets the number of sent pulse to 100.

Options:

Option R&S SMA-K26

Manual control:

See "[Measurement Count - DME Modulation](#)" on page 254

[[:SOURce]:DME:ANALysis:GATE:EDELay] <Edelay>

The command enters the expected reply delay. The expected reply delay and the gate length determine the measurement window (expected reply delay +/- gate length/2).

Parameters:

<Edelay> float
 Range: 0 us to 150 us
 Increment: 1 us
 *RST: Interrogation channel X: 50 us | Interrogation channel
 Y: 56 us
 Default unit: s

Example:

DME:ANAL:GATE:EDEL 50us
 sets an expected reply delay of 50 us

Options:

Option R&S SMA-K26

Manual control:

See "[Expected Reply Delay - DME Modulation](#)" on page 254

[[:SOURce]:DME:ANALysis:GATE[:LENGth] <Length>

The command sets the gate length for the measurement window.

The measurement gate settings determine the measurement window (expected reply delay +/- gate length/2). Only reply pulses for which the 50% voltage point of the rising edge of the first pulse is within the measurement window are used to evaluate the delay time and reply efficiency. The delay measurement is averaged within the measurement cycle. The reply efficiency is calculated once for each measurement cycle.

Example:

The gate length is 1 us and the expected reply delay is 50 us. The measurement window lies in the range between 49.5 and 50.5 us. Only pulse pairs are used for the measurement whose 50% voltage point of the rising edge of the first pulse is within this range.

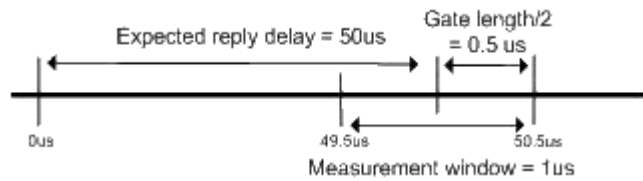
**Parameters:**

<Length> integer
 Range: 100 ns to 326 us
 Increment: 100 ns
 *RST: 1 us
 Default unit: s

Example:

DME:ANAL:GATE 1us
 sets a gate length of 1 us.

Options:

Option R&S SMA-K26

Manual control:

See "[Gate Length - DME Modulation](#)" on page 254

[:SOURce]:DME:ANALysis:NORMalize?

The command performs a normalization of the test setup. The delay due to the test setup is measured and subsequently considered in the reply measurements.

Return values:

<Normalize> 0 | 1 | OFF | ON

Example:

DME:ANAL:NORM?
 activates the normalization

Usage:

Query only

Options:

Option R&S SMA-K26

Manual control:

See "[Normalize Setup - DME Modulation](#)" on page 256

[:SOURce]:DME:ANALysis:POWER?

The command queries the measured average peak level of all valid pulse pairs in a measurement cycle.

Return values:

<Power> float
 Range: -200 to 200
 Increment: 0.01
 *RST: 0

Example:

DME:ANAL:POW:STAT ON
 activates the average peak level measurement
 DME:ANAL:POW?
 queries the measurement result

Usage:

Query only

Options: Option R&S SMA-K26

Manual control: See "[Peak Level - DME Modulation](#)" on page 254

[[:SOURce]:DME:ANALysis:POWer:OK?

The command queries if there are measurement values available in the set measurement window.

Return values:

<Ok> 0 | 1 | OFF | ON
*RST: 1

Example:

DME:ANAL:POW:STAT ON
activates the average peak level measurement
DME:ANAL:POW:OK?
queries if valid measurement values are available
Response: 1
there are valid measurement values
DME:ANAL:POW?
queries the measurement result

Usage: Query only

Options: Option R&S SMA-K26

[[:SOURce]:DME:ANALysis:POWer:STATe <State>

The command activates the measurement of the average peak level of all valid pulse pairs in a measurement cycle.

Parameters:

<State> 0 | 1 | OFF | ON
*RST: ON

Example:

DME:ANAL:POW:STAT ON
activates the average peak level measurement
DME:ANAL:POW?
queries the measurement result

Options: Option R&S SMA-K26

Manual control: See "[Peak Level State - DME Modulation](#)" on page 254

[[:SOURce]:DME:ANALysis:PRRate?

The command queries the measured mean pulse repetition rate of the DME ground station. For this measurement all received pulses of the DME ground station are considered.

Return values:

<Rate> float
 Range: 0 to 10000
 Increment: 0.1
 *RST: 0

Example:

DME:ANAL:PRR:STAT ON
 activates the mean pulse repetition rate measurement
 DME:ANAL:PRR?
 queries the measurement result

Usage: Query only

Options: Option R&S SMA-K26

Manual control: See "[Pulse Repetition Frequency - DME Modulation](#)"
 on page 256

[[:SOURce]:DME:ANALysis:PRRate:OK?

The command queries if there are valid measurement values available in the set measurement window.

Return values:

<Ok> 0 | 1 | OFF | ON
 *RST: 1

Example:

DME:ANAL:PRR:STAT ON
 activates the mean pulse repetition rate measurement
 DME:ANAL:PRR:OK?
 queries if valid measurement values are available
 Response: 1
 there are valid measurement values
 DME:ANAL:PRR?
 queries the measurement result

Usage: Query only

Options: Option R&S SMA-K26

Manual control: See "[Pulse Repetition Frequency - DME Modulation](#)"
 on page 256

[[:SOURce]:DME:ANALysis:PRRate:STATe <State>

The command activates the measurement of the mean pulse repetition rate of the DME ground station. For this measurement all received pulses of the DME ground station are considered.

This measurement and the measurement of the delay, efficiency and average peak power are performed alternately. Therefore, the speed of the pulse repetition measurement increases if all other measurements are deactivated.

Parameters:

<State> 0 | 1 | OFF | ON
 *RST: ON

Example:

DME:ANAL:PRR:STAT ON
 activates the mean pulse repetition rate measurement
 DME:ANAL:PRR?
 queries the measurement result

Options:

Option R&S SMA-K26

Manual control:

See ["Pulse Repetition Frequency State - DME Modulation"](#) on page 255

[[:SOURce]:DME:ANALysis:STATe <State>

The command activates the DME analysis. The setting is only available after connecting the R&S NRP-Z81 power sensor.

Parameters:

<State> 0 | 1 | OFF | ON
 *RST: OFF

Example:

DME:ANAL:STAT ON
 activates the DME analysis

Options:

Option R&S SMA-K26

Manual control:

See ["DME Analysis State - DME Modulation"](#) on page 253

[[:SOURce]:DME:ANALysis:TIME?

The command queries the measured average reply delay of all valid pulse pairs in a measurement cycle.

Return values:

<Time> float
 Range: -1E-3 to 1E-3
 Increment: 10E-9
 *RST: 0

Example:

DME:ANAL:TIME:STAT ON
 activates the average peak level measurement
 DME:ANAL:TIME?
 queries the measurement result

Usage:

Query only

Options:

Option R&S SMA-K26

Manual control:

See ["Reply Delay - DME Modulation"](#) on page 255

[[:SOURce]:DME:ANALysis:TIME:OK?

The command queries if there are valid measurement values available in the set measurement window.

Return values:

<Ok> 0 | 1 | OFF | ON

Example:

DME:ANAL:TIME:STAT ON

activates the average peak level measurement

DME:ANAL:TIME:OK?

queries if valid measurement values are available

Response: 1

there are valid measurement values

DME:ANAL:TIME?

queries the measurement result

Usage:

Query only

Options:

Option R&S SMA-K26

Manual control:

See ["Reply Delay - DME Modulation"](#) on page 255

[[:SOURce]:DME:ANALysis:TIME:STATE <State>

The command activates the measurement of the average reply delay of all valid pulse pairs in a measurement cycle.

Parameters:

<State> 0 | 1 | OFF | ON

*RST: ON

Example:

DME:ANAL:TIME:STAT ON

activates the average reply delay measurement

DME:ANAL:TIME?

queries the measurement result

Options:

Option R&S SMA-K26

Manual control:

See ["Reply Delay Status- DME Modulation"](#) on page 255

[[:SOURce]:DME:ANALysis:TRIGger:SEARch?

Determines the trigger level = 50% voltage point of first pulse of the external DME interrogation signal.

This command determines the trigger point after connecting the R&S NRP-Z81 sensor to the external interrogation signal source. The search function has to be executed with each change of the level of the external DME signal.

Return values:

<Search> 0 | 1 | OFF | ON

*RST: 0

Example:	DME:ANAL:TRIG:SEAR ON executes DME trigger determination.
Usage:	Query only
Options:	Option R&S SMA-K26
Manual control:	See " Search Trigger Level - DME Modulation " on page 247

[:SOURce]:DME:CSUffix <CSuffix>

The command selects the channel that is simulated.

Standard compliant X and Y channels differ in the spacing between the two pulses of the pulse pair and the delay of the ground station.

Parameters:

<CSuffix> X | Y | ICAO
*RST: X

Example: DME:CSUF Y
selects simulation of channel Y

Options: Option R&S SMA-K26

Manual control: See "[Channel Mode - DME Modulation](#)" on page 240

[:SOURce]:DME:ICAO:CHANnel <Channel>

The command selects the ICAO channel i.e., the DME transmitting frequency. The RF-frequency is set to the value selected here.

Parameters:

<Channel> X1 | Y1 | X2 | Y2 | X3 | Y3 | X4 | Y4 | X5 | Y5 | X6 | Y6 | X7 | Y7 |
 X8 | Y8 | X9 | Y9 | X10 | Y10 | X11 | Y11 | X12 | Y12 | X13 | Y13 |
 X14 | Y14 | X15 | Y15 | X16 | Y16 | X17 | Y17 | X18 | Y18 | X19 |
 Y19 | X20 | Y20 | X21 | Y21 | X22 | Y22 | X23 | Y23 | X24 | Y24 |
 X25 | Y25 | X26 | Y26 | X27 | Y27 | X28 | Y28 | X29 | Y29 | X30 |
 Y30 | X31 | Y31 | X32 | Y32 | X33 | Y33 | X34 | Y34 | X35 | Y35 |
 X36 | Y36 | X37 | Y37 | X38 | Y38 | X39 | Y39 | X40 | Y40 | X41 |
 Y41 | X42 | Y42 | X43 | Y43 | X44 | Y44 | X45 | Y45 | X46 | Y46 |
 X47 | Y47 | X48 | Y48 | X49 | Y49 | X50 | Y50 | X51 | Y51 | X52 |
 Y52 | X53 | Y53 | X54 | Y54 | X55 | Y55 | X56 | Y56 | X57 | Y57 |
 X58 | Y58 | X59 | Y59 | X60 | Y60 | X61 | Y61 | X62 | Y62 | X63 |
 Y63 | X64 | Y64 | X65 | Y65 | X66 | Y66 | X67 | Y67 | X68 | Y68 |
 X69 | Y69 | X70 | Y70 | X71 | Y71 | X72 | Y72 | X73 | Y73 | X74 |
 Y74 | X75 | Y75 | X76 | Y76 | X77 | Y77 | X78 | Y78 | X79 | Y79 |
 X80 | Y80 | X81 | Y81 | X82 | Y82 | X83 | Y83 | X84 | Y84 | X85 |
 Y85 | X86 | Y86 | X87 | Y87 | X88 | Y88 | X89 | Y89 | X90 | Y90 |
 X91 | Y91 | X92 | Y92 | X93 | Y93 | X94 | Y94 | X95 | Y95 | X96 |
 Y96 | X97 | Y97 | X98 | Y98 | X99 | Y99 | X100 | Y100 | X101 |
 Y101 | X102 | Y102 | X103 | Y103 | X104 | Y104 | X105 | Y105 |
 X106 | Y106 | X107 | Y107 | X108 | Y108 | X109 | Y109 | X110 |
 Y110 | X111 | Y111 | X112 | Y112 | X113 | Y113 | X114 | Y114 |
 X115 | Y115 | X116 | Y116 | X117 | Y117 | X118 | Y118 | X119 |
 Y119 | X120 | Y120 | X121 | Y121 | X122 | Y122 | X123 | Y123 |
 X124 | Y124 | X125 | Y125 | X126 | Y126

*RST: X1

Example:

DME:ICAO:CHAN Y2
 selects ICAO frequency channel 2Y. This channel sets the RF
 frequency to 1089 MHz.

Options:

Option R&S SMA-K25

Manual control:

See "[ICAO Channel - DME Modulation](#)" on page 241

[[:SOURce]:DME:EFFiciency <Efficiency>

The command sets the relation between reply pulse pairs and received trigger signals, e.g. with a set efficiency of 50% only every second trigger event leads to the generation of a reply pulse pair.

Parameters:

<Efficiency> float
 Range: 0 PCT to 100 PCT
 Increment: 1
 *RST: 100 PCT

Example:

DME:MODE REPL
 activates the reply mode
 DME:EFF 75PCT
 sets a reply efficiency of 75 PCT

Options: Option R&S SMA-K26

Manual control: See ["Reply Efficiency - DME Modulation"](#) on page 244

[:SOURce]:DME:FALL <Fall>

Sets the fall time of the pulse (90% to 10% of peak voltage).

Parameters:

<Fall> float
 Range: 0.5 us to 20 us
 Increment: 10 ns
 *RST: 2 us

Example: DME:FALL 4us
 sets a pulse fall time of 4 us

Options: Option R&S SMA-K26

Manual control: See ["Pulse Fall - DME Modulation"](#) on page 245

[:SOURce]:DME:ID:CODE <Code>

Enters the coding of the ID signal by the international short name of the airport (e.g. MUC for the Munich airport). (ID signal). The ID tone is sent according to the selected code. This command is available for reply mode only.

The length of the morse code can be varied. For selection standard time scheme (DME:ID:TSCH STD), the selected dot length determines the setting of all other length parameters of the morse code (dash length, symbol space and letter space). For selection user time scheme (DME:ID:TSCH USER), all length parameters of the code can be set independently.

Parameters:

<Code> string
 *RST: empty string

Example: DME:MODE REPL
 selects reply mode
 DME:ID:CODE 'MUC'
 selects code for Munich airport

Options: Option R&S SMA-K26

Manual control: See ["ID Code - DME Modulation"](#) on page 249

[:SOURce]:DME:ID:DASH <Dash>

Enters the length of a morse dash by means of seconds. This command is available for reply mode and user time schema only.

Parameters:

<Dash> float
 Range: 50 ms to 1 s
 Increment: 0.1 ms
 *RST: 300 ms
 Default unit: s

Example:

```
DME:MODE REPL
selects reply mode
DME:ID:CODE 'MUC'
selects code for Munich airport
DME:ID:TSCH USER
selects user time schema
DME:ID:DOT 200ms
sets a dot length of 200 ms.
DME:ID:DASH 400ms
sets a dash length of 400 ms.
DME:ID:LETT 50ms
sets a letter space of 50 ms.
DME:ID:SYMB 10ms
sets a symbol space of 10 ms.
```

Options: Option R&S SMA-K26

Manual control: See "[ID Dash Length - DME Modulation](#)" on page 251

[[:SOURce]:DME:ID:DOT <Dot>

Enters the length of a morse dot by means of seconds. The length of the dash (3xdot), space (=dot) and letter space (=3xdot) is also determined by this entry. This command is available for reply mode only.

Parameters:

<Dot> float
 Range: 50 ms to 1 s
 Increment: 0.1 ms
 *RST: 100 ms
 Default unit: s

Example:

```
DME:MODE REPL
selects reply mode
DME:ID:CODE 'MUC'
selects code for Munich airport
DME:ID:DOT 200ms
sets a dot length of 200 ms.
```

Options: Option R&S SMA-K26

Manual control: See "[ID Dot Length - DME Modulation](#)" on page 251

[[:SOURce]:DME:ID:LETTer <Letter>

Enters the length of a letter space by means of seconds. This command is available for reply mode and user time schema only.

Parameters:

<Letter> float
 Range: 50 ms to 1 s
 Increment: 0.1 ms
 *RST: 300 ms
 Default unit: s

Example:

```
DME:MODE REPL
'selects reply mode
DME:ID:CODE 'MUC'
'selects code for Munich airport
DME:ID:TSCH USER
'selects user time schema
DME:ID:DOT 200ms
'sets a dot length of 200 ms.
DME:ID:DASH 400ms
'sets a dash length of 400 ms.
DME:ID:LETT 50ms
'sets a letter space of 50 ms.
DME:ID:SYMB 10ms
sets a symbol space of 10 ms.
```

Options: Option R&S SMA-K26

Manual control: See ["ID Letter Space - DME Modulation"](#) on page 251

[[:SOURce]:DME:ID:PERiod <Period>

Enters the period of the ID sequence by means of seconds. This command is available for reply mode only.

Parameters:

<Period> float
 Range: 10 s to 120 s
 Increment: 1 s
 *RST: 40 s
 Default unit: s

Example:

```
DME:MODE REPL
selects reply mode
DME:ID:CODE 'MUC'
selects code for Munich airport
DME:ID:DOT 200ms
sets a dot length of 200 ms.
DME:ID:PER 40
sets a period of 40 s for the ID sequence
```

Options: Option R&S SMA-K26
Manual control: See ["ID Period - DME Modulation"](#) on page 250

[[:SOURce]:DME:ID:PRESet

The command sets the default settings for the ID signal. This command is available for reply mode only.

Example: `DME:ID:PRES`
 activates the default settings for all SOURce:DME:ID... commands.

Usage: Event

Options: Option R&S SMA-K26

Manual control: See ["Set To Default ID - DME Modulation"](#) on page 251

[[:SOURce]:DME:ID:RATE <Rate>

Enters the pulse repetition rate of the ID sequence. This command is available for reply mode only.

Parameters:

<Rate> float
 Range: 100 Hz to 10 kHz
 Increment: 0.1 Hz
 *RST: 1350 Hz
 Default unit: Hz

Example: `DME:ID:RATE 2500`
 sets a repetition rate of the ID sequence of 2.5 kHz

Options: Option R&S SMA-K26

Manual control: See ["ID Rate - DME Modulation"](#) on page 250

[[:SOURce]:DME:ID[:STATe] <State>

Switches on/off the generation of the identification sequence (ID signal) of the ground station. The ID signal consists of a series of pulse pairs transmitted at a rate of 1350 Hz.

The transmission of the ground signal is interrupted every 40 seconds (ID period) and one ID sequence is transmitted instead. The "key down time" of the ground signal corresponds to the period of transmission for a dot or dash in the morse code ID sequence (e.g. 100ms for a dot). During the key down times reply pulses are not transmitted, however, they are transmitted between the key down times.

Parameters:

<State> 0 | 1 | OFF | ON
 *RST: OFF

- Example:** `DME:ID ON`
activates generation of the identification sequence.
- Options:** Option R&S SMA-K26
- Manual control:** See "[ID State - DME Modulation](#)" on page 249

[[:SOURce]:DME:ID:SYMBOL <Symbol>

Enters the length of the symbol space by means of seconds. This command is available for reply mode and user time schema only.

Parameters:

<Symbol> float
Range: 50 ms to 1 s
Increment: 0.1 ms
*RST: 100 ms
Default unit: s

- Example:** `DME:MODE REPL`
selects reply mode
`DME:ID:CODE 'MUC'`
selects code for Munich airport
`DME:ID:TSCH USER`
selects user time schema
`DME:ID:DOT 200ms`
sets a dot length of 200 ms.
`DME:ID:DASH 400ms`
sets a dash length of 400 ms.
`DME:ID:LETT 50ms`
sets a letter space of 50 ms.
`DME:ID:SYMB 10ms`
sets a symbol space of 10 ms.

- Options:** Option R&S SMA-K26
- Manual control:** See "[ID Symbol Space - DME Modulation](#)" on page 251

[[:SOURce]:DME:ID:TSCHEMA <TSchema>

Selects if the set dot length determines the dash length (= three times the dot length) (setting STD) or if all length parameters can be set independently (setting USER). (ID signal).

Parameters:

<TSchema> STD | USER
*RST: USER

- Example:** DME:MODE REPL
selects reply mode
DME:ID:CODE 'MUC'
selects code for Munich airport
DME:ID:TSCH STD
selects standard time schema
DME:ID:DOT 200ms
sets a dot length of 200 ms. The dash length and letter space is 3 x dot length, the symbol space equals the dot length.
- Options:** Option R&S SMA-K26
- Manual control:** See "[ID Time Schema - DME Modulation](#)" on page 250

[[:SOURce]:DME:LOWemission <LowEmission>

Activates the generation of a DME signal with higher spectral purity but less dynamic compared to the default mode. The ON/OFF ratio of the pulses is reduced from typ. >100 dB to typ. 35 dB.

Parameters:

<LowEmission> 0 | 1 | OFF | ON
*RST: OFF

- Example:** DME:LOW ON
activates the generation of a DME signal with higher spectral purity
- Options:** Option R&S SMA-K26
- Manual control:** See "[Low Spectral Emission - DME Modulation](#)" on page 245

[[:SOURce]:DME:MODE <Mode>

Selects the mode of the DME modulation. The mode determines the signal type that is simulated. The exact timing of the signal for each mode is determined by the selected channel (X or Y, SOURce:DME:CSUFFix).

Parameters:

<Mode> INTerrogation | REPLy

INTerrogation

The interrogation signal of the airborne transmitter is simulated.

REPLy

The reply signal of the ground based transponder is simulated. The trigger is automatically set to external and the default trigger delay either to 50 us (channel X) or 56 us (channel Y) depending on the selected channel (SOURce:DME:CSUFFix). The interval between the pulse pairs can be set to a fixed value (repetition rate, SOURce:DME:RATE) or to random generation (pulse squitter, SOURce:DME:SQUitter). The trigger signal is input via the PULSE EXT connector.

*RST: INTerrogation

- Example:** `DME:MODE INT`
Activates generation of the interrogation signal of the airborne transmitter.
- Options:** Option R&S SMA-K26
- Manual control:** See "[Mode - DME Modulation](#)" on page 238

[[:SOURce]:DME:PPS <Pps>

Sets the spacing between the first and second pulse of a pulse pair (time between half-voltage points on the leading edge of each pulse).

Parameters:

<Pps> float
Range: 1 us to 100 us
Increment: 5 ns
*RST: 12 us

Example: `DME:PPS 14us`
sets a spacing of 14us

- Options:** Option R&S SMA-K26
- Manual control:** See "[Pulse Spacing - DME Modulation](#)" on page 245

[[:SOURce]:DME:PRESet

The commands activate the DME default setting.

Example: `DME:PRES`
activates the DME default settings for all `SOURce:DME:...` commands.

- Usage:** Event
- Options:** Option R&S SMA-K26
- Manual control:** See "[Set To Default - DME Modulation](#)" on page 245

[[:SOURce]:DME:RATE <Rate>

Interrogation mode:

Sets the pulse repetition rate for trigger setting Auto or Ext Gated.

Delay mode:

Indicates the mean pulse repetition rate in squitter mode.

Parameters:

<Rate> integer
Range: 10 Hz to 6000 Hz
Increment: 1 Hz
*RST: 48 Hz

Example: DME:MODE INT
selects interrogation mode
DME:TRIG AUTO
selects auto trigger mode
DME:RATE 48 Hz
sets a pulse repetition rate of 48 Hz

Options: Option R&S SMA-K26

Manual control: See "[Pulse Repetition Rate - DME Modulation](#)" on page 244

[[:SOURce]:DME:RDISTance <RDistance>

Sets the simulated distance between interrogator and transponder for reply mode. The distance is given in nautic miles (nm). 1 nm is 1852.01 meters and corresponds to a run time of 12.359 μ s. This command is available for reply mode only.

The range distance and the external trigger delay are interdependent according to:

range distance = (trigger delay – X/Y mode delay)/12.359 μ s/nm

(X mode delay = 50 μ s, Y mode delay is 56 μ s)

Changing one value automatically changes the other value.

Parameters:

<RDistance> float
Range: -4.046 (X), -4.531 (Y) to 400
Increment: 0.001 nm
*RST: 0 nm
Default unit: nm

Example: DME:MODE REPL
selects reply mode
DME:RDIS 0.1 nm
sets a range distance of 0.1 nautic mile

Options: Option R&S SMA-K26

Manual control: See "[Range Distance - DME Modulation](#)" on page 243

[[:SOURce]:DME:RISE <Rise>

Sets the rise time of the pulse (10% to 90% of peak voltage).

Parameters:

<Rise> float
Range: 0.5 μ s to 20 μ s
Increment: 10 ns
*RST: 2 μ s

Example: DME:RISE 4 μ s
sets a pulse rise time of 4 μ s

Options: Option R&S SMA-K26

Manual control: See ["Pulse Rise - DME Modulation"](#) on page 244

[:SOURce]:DME:SHAPE <Shape>

Selects the pulse shape.

Parameters:

<Shape> COS2 | LIN | COS

COS

The falling and the rising edge of the pulse are \cos^2 shaped.

COS2

The rising edge is \cos shaped and the falling edge is \cos^2 shaped.

LIN

The falling and the rising edge of the pulse are shaped linear.

*RST: COS

Example:

DME:SHAP COS

selects generation of pulses with \cos shaped rising and falling edges

Options:

Option R&S SMA-K26

Manual control: See ["Pulse Shape - DME Modulation"](#) on page 244

[:SOURce]:DME:SINGLE <Single>

Activates generation of a single test pulse.

Parameters:

<Single> 0 | 1 | OFF | ON

*RST: OFF

Example:

DME:SING ON

a single test pulse is generated

Options:

Option R&S SMA-K26

Manual control: See ["Single Pulse - DME Modulation"](#) on page 245

[:SOURce]:DME:SQUitter <Squitter>

Activates the random pulse repetition rate. The average repetition rate is 2700 pp/s. The pulse spacing is distributed randomly in the range of 60 μ s to about 1500 μ s according to EUROCAE EN-54 6.2.12. The squitter pulses are constantly sent by the ground station in order to ensure proper operation and in order to ease synchronization of the aircraft interrogator to the ground station.

This command is available for Reply mode on only.

Parameters:

<Squitter> 0 | 1 | OFF | ON
 *RST: OFF

Example:

DME:MODE REPL
 selects reply mode
 DME:SQU ON
 activates generation of squitter pulses.

Options:

Option R&S SMA-K26

Manual control:

See ["Pulse Squitter - DME Modulation"](#) on page 243

[[:SOURce]:DME:STATe <State>

The commands activate/deactivate DME modulation. The DME modulation signal can be output at the LF connector.

Note: Modulations PULSE, VOR, ILS-GS, ILS-LOC, MKR-BCN, ADF, AM, and internal FM/PhiM are automatically switched off when DME modulation is activated. Also, the pulse generator is automatically switched off.

Parameters:

<State> 0 | 1 | OFF | ON
 *RST: OFF

Example:

DME:STAT ON
 activates DME modulation.

Options:

Option R&S SMA-K26

Manual control:

See ["State - DME Modulation"](#) on page 238

[[:SOURce]:DME:TACan:DEPT h <Depth>

Sets the modulation depth in per cent.

Note: Observe that this value is valid for both signal components of the two-tone signal and the sum modulation depth is determined by doubling the set modulation depth. This results in overmodulation if the maximal value for modulation depth is exceeded (see data sheet).

Parameters:

<Depth> float
 Range: 0 PCT to 100 PCT
 Increment: 0.1
 *RST: 42 PCT
 Default unit: PCT

Example:

DME:TAC:DEPT 30PCT
 sets the overall AM modulation depth to 30 percent. With this setting the modulation depth of the two LF generators are automatically set to 15 percent each.

Options: R&S SMA-K26

Manual control: See "[Composite AM Depth - DME Modulation](#)" on page 252

[:SOURce]:DME:TACan:INTernal<ch>:DEPTH <Depth>

This command sets the modulation depth for one component of the two-tone signal in per cent.

Note: The sum of the two components must not exceed the overall modulation depth (see data sheet).

Parameters:

<Depth> float
 Range: 0 PCT to 100 PCT
 Increment: 0.1 PCT
 *RST: 21 PCT
 Default unit: PCT

Example: DME:TAC:INT1:DEPT 20PCT
 sets the AM modulation depth to 20 percent for the first tone. With setting 42 percent for the overall modulation depth, the modulation depth of the second tone is automatically set to 22 percent.

Options: R&S SMA-K26

Manual control: See "[Composite AM Depth 1/2 - DME Modulation](#)" on page 253

[:SOURce]:DME:TACan:PHASe <Phase>

This commands sets the phase of the two-tone signal.

Parameters:

<Phase> float
 Range: -180 to 180
 Increment: 0.01
 *RST: 0
 Default unit: DEGREE

Example: DME:TAC:STAT ON
 activates Composite AM modulation.

Options: Option R&S SMA-K26

[:SOURce]:DME:TACan<ch>:FREQuency <Frequency>

Sets the individual frequencies of the two-tone signal.

Parameters:

<Frequency> float
 Range: 0.10 Hz to 10.0 kHz
 Increment: 0.01
 *RST: 15 Hz <ch1>, 135 Hz <ch2>
 Default unit: Hz

Example:

```
SOUR:DME:TAC1:FREQ 0.7 Hz
SOUR:DME:TAC2:FREQ 77.33 Hz
```

sets the first frequency to 0.7 Hz, and the second to 77.33 Hz.

Options:

R&S SMA-K26

Manual control:

See "[Composite AM Frequency 1/2 - DME Modulation](#)" on page 253

[:SOURce]:DME:TACan:STATe <State>

This functions activates/deactivates the two-tone signal.

Parameters:

<State> 0 | 1 | OFF | ON
 *RST: OFF

Example:

```
DME:TAC:STAT ON
```

activates Composite AM modulation.

Options:

Option R&S SMA-K26

Manual control:

See "[Composite AM State - DME Modulation](#)" on page 252

[:SOURce]:DME:TRIGger <Trigger>

Selects the trigger mode for DME modulation signals. For Reply mode only external trigger is possible

Parameters:

<Trigger>

AUTO | EXTERNAL | EGATE | PSENSOR

AUTO

The DME modulation signals are generated continuously. This mode is only available for the interrogation signal.

EXTERNAL

The DME modulation signals are triggered by an external trigger event. The trigger signal is supplied via the PULSE EXT connector.

EGATE

The DME modulation signals are gated by an external gate signal. The signal is supplied via the PULSE EXT connector. This mode is only available for the interrogation signal.

PSENSOR

The DME modulation signals are triggered by an external power sensor. This mode is only available for the interrogation signal.

*RST: Interrogation Mode: AUTO; Reply Mode: EXTERNAL

Example:

DME:TRIG EXT

activates external trigger mode

Options:

Option R&S SMA-K26

Manual control:See "[Trigger Mode - DME Modulation](#)" on page 246**[[:SOURce]:DME:TRIGger:DELay <Delay>**

Sets the delay between the external trigger and the first DME output pulse (50% voltage point of first pulse). This command is effective for external trigger only.

For DME Reply mode this simulates the defined delay of the DME transponder and twice the run time of the signal (from interrogator to transponder and back). The delay is a measure of the range distance, thus, the two values are interdependent according to:

$$\text{Delay} = X/Y \text{ mode delay} + \text{range distance} * 12.359 \text{ nm}/\mu\text{s}$$

(X mode delay = 50 μs , Y mode delay is 56 μs)

Changing one value automatically changes the other value.

Parameters:

<Delay>

float

Range: 4 μs to 5 ms

Increment: 20 ns

*RST: Reply X: 50 μs | Reply Y: 56 μs | Interrogation: 50 μs **Example:**

DME:TRIG EXT

activates external trigger mode

DME:TRIG:DEL 150us

sets a delay of 150us

Options:

Option R&S SMA-K26

Manual control: See ["Trigger Delay - DME Modulation"](#) on page 246

[[:SOURce]:DME:TRIGger:DELay:NORMalize?

Performs a normalization of the test setup. The delay due to the test setup is measured and subsequently considered in the trigger delay. This command is effective for external power sensor trigger only.

Return values:

<Normalize> 0 | 1 | OFF | ON

Example:

```
DME:TRIG PSEN
activates external power sensor trigger mode
DME:TRIG:DEL:NORM?
performs normalization of test setup
```

Usage: Query only

Options: Option R&S SMA-K26

Manual control: See ["Normalize Trigger Delay - DME Modulation"](#) on page 247

[[:SOURce]:DME:TRIGger:GPOLarity <GPolarity>

Sets the polarity of the active level of the external gate trigger at the PULSE EXT connector. This command is effective for external gate only.

Parameters:

<GPolarity> NORMal | INVerted

NORMal

The DME modulation signal is generated while the gate signal is high.

INVerted

The DME modulation signal is generated while the gate signal is low.

*RST: NORMal

Example:

```
DME:TRIG GATE
activates external gate mode
DME:TRIG:GPOL INV
the signal is generated while the gate level is high.
```

Options: Option R&S SMA-K26

Manual control: See ["Gate Input Polarity - DME Modulation"](#) on page 247

[[:SOURce]:DME:TRIGger:IMPedance <Impedance>

Selects the input impedance for the external trigger and gate signal input PULSE EXT (10 kOhm or 50 Ohm). This command applies to external or gated trigger mode.

Parameters:

<Impedance> G50 | G10K
 *RST: G50

Example:

DME:TRIG EXT
 activates external trigger mode
 DME:TRIG:IMP G50
 sets the impedance to 50 Ohm.

Options:

Option R&S SMA-K26

Manual control:

See "[External Impedance - DME Modulation](#)" on page 247

[[:SOURce]:DME:TRIGger:SLOPe <Slope>

Sets the polarity of the active slope of an applied trigger at the PULSE EXT connector. This command is effective for external trigger only.

Parameters:

<Slope> NEGative | POSitive

POSitive

The DME modulation signals are triggered on the positive slope of the external trigger signal.

NEGative

The DME modulation signals are triggered on the negative slope of the external trigger signal.

*RST: POSitive

Example:

DME:TRIG EXT
 activates external trigger mode
 DME:TRIG:SLOP NEG
 the active slope of the external trigger signal at the PULSE EXT input is the falling slope.

Options:

Option R&S SMA-K26

Manual control:

See "[Trigger Slope - DME Modulation](#)" on page 247

[[:SOURce]:DME:WIDTh <Width>

Sets the pulse width (50% to 50% of peak voltage).

Parameters:

<Width> float
 Range: 1 us to 100 us
 Increment: 2 ns
 *RST: 3.5 us

Example:

DME:WIDT 12us
 sets a pulse width of 12us

Options:

Option R&S SMA-K26

Manual control: See ["Pulse Width - DME Modulation"](#) on page 245

7.13.6 SOURce:FM Subsystem

The FM subsystem contains the commands for checking the frequency modulation.

The FM-specific characteristics of the internal modulation source are defined with commands `SOURce:FM:INTernal: . . .`. Characteristics which are valid for all modulations and the LF Output are configured in the `SOURce:LFOuTput` subsystem (e.g. frequency). The external signal is input at the FM/PM EXT connector. Internal and external modulation source can be selected at the same time, thus enabling two-tone FM modulation.

For information about the required options, see [chapter 5.4.3, "Frequency Modulation \(FM\)"](#), on page 218.

[:SOURce<hw>]:FM[:DEViation]	496
[:SOURce<hw>]:FM:EXTernal:COUPling	496
[:SOURce<hw>]:FM:EXTernal:DEViation	497
[:SOURce<hw>]:FM:EXTernal:DIGital:BFORmat	497
[:SOURce<hw>]:FM:INTernal<ch>:DEViation	498
[:SOURce<hw>]:FM:INTernal:SOURce	498
[:SOURce<hw>]:FM:MODE	498
[:SOURce<hw>]:FM:SENSitivity?	499
[:SOURce<hw>]:FM:SOURce	499
[:SOURce<hw>]:FM:STATe	500

`[:SOURce<hw>]:FM[:DEViation]` <Deviation>

The command sets the modulation deviation of the frequency modulation in Hz. The maximal deviation depends on the RF frequency set and the selected modulation mode (see data sheet).

Parameters:

<Deviation>	float
	Range: 0 Hz to 10 MHz
	Increment: See data sheet
	*RST: 10 kHz
	Default unit: Hz

Example: `FM 5E3`
sets the FM modulation deviation to 5 kHz.

Usage: SCPI confirmed

Options: Option R&S SMA-B20 or R&S SMA-B22

Manual control: See ["FM Deviation"](#) on page 220

`[:SOURce<hw>]:FM:EXTernal:COUPling` <Coupling>

The command selects the coupling mode for the external modulation input in the case of frequency modulation.

Note: Coupling for external feed via input FM/PM EXT can be set independently for modulations FM and PhiM.

Parameters:

<Coupling> AC | DC

AC

The DC voltage component is disconnected from the modulation signal.

DC

The modulation signal is not changed.

*RST: AC

Example:

FM:EXT:COUP AC

selects the coupling mode AC for external frequency modulation.

Usage:

SCPI confirmed

Options:

Option R&S SMA-B20 or R&S SMA-B22

Manual control:

See "[FM External Coupling](#)" on page 222

[:SOURce<hw>]:FM:EXTernal:DEViation <Deviation>

The command enters the deviation of the external FM signal. The deviation of the internal source must not exceed the deviation of the external source in case of modulation source Int+Ext.

Parameters:

<Deviation> float

Range: 0 to 40 MHz

*RST: 1kHz

Default unit: Hz

Example:

FM:EXT:DEV 3kHz

sets an external modulation depth of 3 kHz

Usage:

SCPI confirmed

Options:

Option R&S SMA-B20 or R&S SMA-B22

[:SOURce<hw>]:FM:EXTernal:DIGital:BFORmat <Bformat>

The command selects the binary format for external digital frequency modulation.

Parameters:

<Bformat> BOFFset | DCODE

Example:

FM:EXT:DIG:BFOR BOFF

selects binary format binary offset.

Usage:

SCPI confirmed

Options:

Option R&S SMA-B20 or R&S SMA-B22

Manual control:

See "[Binary Format](#)" on page 222

[:SOURce<hw>]:FM:INTernal<ch>:DEVIation <Deviation>

The command selects the deviation for the two frequency modulation signals. The sum of the two values must not exceed the overall modulation deviation set with command `SOURce:FM:DEVIation`.

Parameters:

<Deviation> float
 Range: 0 to 20 MHz
 *RST: LF1: 1 kHz, LF2: 0 kHz

Usage: SCPI confirmed

Options: Option R&S SMA-B20 or R&S SMA-B22; Option R&S SMA-K24

Manual control: See "[Deviation 1/Deviation 2](#)" on page 221

[:SOURce<hw>]:FM:INTernal:SOURce <Source>

Selects which internal modulation source is used. The available selection depends on the options fitted.

Parameters:

<Source> LF1 | LF2 | LF12 | NOISe | LF1Noise | LF2Noise

Example:

`FM:INT:SOUR LF2N`
 selects LF generator 2 and noise generator as internal modulation sources

Usage: SCPI confirmed

Options: Option R&S SMA-B20 or R&S SMA-B22; Option R&S SMA-K24 for selections other than LF1

Manual control: See "[Internal Source](#)" on page 220

[:SOURce<hw>]:FM:MODE <Mode>

The command selects the mode for the frequency modulation.

Parameters:

<Mode> NORMal | LNOise

NORMal

The maximum range for modulation bandwidth and FM deviation is available.

LNOise

Frequency modulation with phase noise and spurious characteristics close to CW mode. The range for modulation bandwidth and FM deviation is reduced (see data sheet).

*RST: NORMal

Example:

`FM:MODE NORM`
 selects normal mode for external frequency modulation.

Usage:	SCPI confirmed
Options:	Option R&S SMA-B20 or R&S SMA-B22
Manual control:	See " FM Mode " on page 219

[:SOURce<hw>]:FM:SENSitivity?

The command queries the input sensitivity of the FM/PM EXT input in Hz/V.

The command is only effective if the external modulation source is selected (SOUR:FM:SOUR EXT). The returned value depends on the modulation deviation setting (SOUR:FM:DEVIation). This value is assigned to the voltage value for full modulation of the input signal.

Return values:

<Sensitivity> float

Example:

```
FM:DEV 5E3
```

sets a modulation deviation of 5 kHz.

```
FM:SENS
```

queries the input sensitivity at the external modulation input.

```
Response: 5E3
```

since the voltage value for full modulation is 1V, the resulting sensitivity is precisely 5000Hz/V.

Usage: Query only
SCPI confirmed

Options: Option R&S SMA-B20 or R&S SMA-B22

Manual control: See "[FM Sensitivity](#)" on page 221

[:SOURce<hw>]:FM:SOURce <Source>

The command selects the modulation source for frequency modulation. Internal and external modulation source can be selected at the same time.

Parameters:

<Source> INT | EXT | INT,EXT

INT

INT is the internal modulation source which is defined with command FM:SOURce:INTernal and configured in the SOURce:LFOutput subsystem.

EXT

The external analog signal is input at the FM/PM EXT connector. The external digital signal is input at the AUX I/O connector (selection EDIGital).

*RST: INTernal

Example:	FM: SOUR INT selects the internal modulation source. FM: INT: SOUR LF2 selects the LF generator 2 as internal modulation source.
Usage:	SCPI confirmed
Options:	Option R&S SMA-B20 or R&S SMA-B22
Manual control:	See "FM Source" on page 219

[:SOURce<hw>]:FM:STATe <State>

The command activates/deactivates frequency modulation.

Activation of FM (FM: STAT ON) deactivates phase modulation.

Parameters:

<State> 0 | 1 | OFF | ON
*RST: OFF

Example: FM: STAT ON
Activates FM modulation.

Usage: SCPI confirmed

Options: Option R&S SMA-B20 or R&S SMA-B22

Manual control: See "State" on page 219

7.13.7 SOURce:FREQuency Subsystem

This subsystem contains the commands used to define the frequency settings for the RF sources and sweeps.

[:SOURce<hw>]:FREQuency:CENTer	501
[:SOURce<hw>]:FREQuency[:CW FIXed]	501
[:SOURce<hw>]:FREQuency[:CW FIXed]:RCL	502
[:SOURce<hw>]:FREQuency:MANual	502
[:SOURce<hw>]:FREQuency:MODE	503
[:SOURce<hw>]:FREQuency:MULTiplier	504
[:SOURce<hw>]:FREQuency:OFFSet	504
[:SOURce<hw>]:FREQuency:PHASe:CONTInuous:HIGH?	504
[:SOURce<hw>]:FREQuency:PHASe:CONTInuous:LOW?	505
[:SOURce<hw>]:FREQuency:PHASe:CONTInuous:MODE	505
[:SOURce<hw>]:FREQuency:PHASe:CONTInuous:STATe	506
[:SOURce<hw>]:FREQuency:SPAN	506
[:SOURce<hw>]:FREQuency:STARt	507
[:SOURce<hw>]:FREQuency:STOP	508
[:SOURce<hw>]:FREQuency:STEP[:INCRement]	508
[:SOURce<hw>]:FREQuency:STEP:MODE	509

[[:SOURce<hw>]:FREQUENCY:CENTer <Center>

The command sets the center frequency of the sweep. This setting in combination with the span setting ([SOURce:]FREQUENCY:SPAN) defines the sweep range.

This command is linked to the commands [SOURce:]FREQUENCY:START and [SOURce:]FREQUENCY:STOP, i.e. changing these values causes the CENTER value to change, and vice versa:

$$\text{CENTer} = (\text{START} + \text{STOP}) / 2$$

As with the "Frequency" value entered in the header, the OFFSet value is also taken into consideration with this command. The specified value range is therefore only effective if OFFSet is set to 0. The value range for other OFFset values can be calculated using the following formula:

$$300 \text{ kHz} + \text{OFFSet} \dots \text{RF}_{\text{max}} + \text{OFFSet}$$

Parameters:

<Center>	float
	Range: RFmin to RFmax (depending on model)
	Increment: 0.01Hz
	*RST: 300MHz
	Default unit: Hz

Example:

```
FREQ:CENT 400 MHz
```

sets the center frequency for the frequency sweep to 400 MHz.

```
FREQ:SPAN 200 MHz
```

sets a span of 200 MHz. This sets the sweep range to 300 MHz to 500 MHz.

Manual control: See ["Center Freq - Frequency Sweep"](#) on page 194

[[:SOURce<hw>]:FREQUENCY[:CW|FIXed] <Fixed>

The command sets the frequency of the RF output signal for CW mode (SOURce:FREQUENCY:MODE CW). In Sweep mode (SOURce:FREQUENCY:MODE SWEep), this value is linked to the current sweep frequency.

In addition to a numerical value, it is also possible to specify UP and DOWN. The frequency is then increased or decreased by the value which is set under [SOURce< [1] | 2>:]FREQUENCY:STEP.

As with the "FREQ" value entered in the display, the OFFSet value is also taken into consideration with this command. The specified value range is therefore only effective if OFFSet is set to 0. The value range for other OFFset values can be calculated using the following formula:

$$\text{RF}_{\text{min}} + \text{OFFSet} + \text{MULTiplier} \dots \text{RF}_{\text{max}} + \text{OFFSet} + \text{MULTiplier}$$

Correlation: FREQ for FREQ:MODE SWE is linked to sweep frequency.

Parameters:

<Fixed> float
 Range: RFmin to RFmax (depending on model)
 Increment: 0.01 Hz
 *RST: 100 MHz
 Default unit: HZ

Example:

FREQ 500kHz
 sets the frequency of RF output signal A to 500 kHz.

Manual control:

See "[RF Freq](#)" on page 116

[:SOURce<hw>]:FREQuency[:CW|FIXed]:RCL <Rcl>

The command determines whether the current frequency setting is retained or whether the stored frequency setting is adopted when an instrument configuration is loaded.

*RST does not affect this setting.

Parameters:

<Rcl> INCLude | EXCLude

INCLude

The stored frequency is also loaded when a stored instrument configuration is loaded.

EXCLude

The RF frequency is not loaded when a stored instrument configuration is loaded. The current frequency is retained.

*RST: INCLude

Example:

FREQ:RCL INCL
 The stored frequency is set if the Recall command is called.

Manual control:

See "[Exclude Frequency](#)" on page 111

[:SOURce<hw>]:FREQuency:MANual <Manual>

In Sweep mode (:SOUR:FREQ:MODE SWE) the command sets the frequency for the next sweep step in the "Step" sweep mode (SOUR:SWE:MODE MAN).

The parameter **<Manual>** must be a frequency value between the settings [SOUR]:FREQ:STAR and ...:STOP. Each sweep step is triggered by a separate SOUR:FREQ:MAN command. UP or DOWN trigger the next sweep step in direction of higher or lower frequencies.

As with the "Frequency" value entered in the header, the OFFSet value is also taken into consideration with this command. The specified value range is therefore only effective if OFFSet is set to 0. The value range for other OFFSet values can be calculated using the following formula:

$$\text{START} + \text{OFFSet} \dots \text{STOP} + \text{OFFSet}$$

Parameters:

<Manual> float
 Range: START to STOP
 Increment: 0.01Hz
 *RST: 100MHz
 Default unit: Hz

Example:

SWE:MODE MAN
 sets the Step sweep mode.

Example:

FREQ:MODE SWE
 sets the Frequency Sweep mode. The sweep start frequency is output.
 FREQ:MAN UP
 triggers the next higher sweep step.
 FREQ:MAN 500MHz
 outputs 500 MHz RF frequency (must e within the sweep frequency range).
 FREQ:MAN DOWN
 triggers the next lower sweep step relative to 500 MHz.

Usage:

SCPI confirmed

Manual control:

See "[Current Freq - Frequency Sweep](#)" on page 194

[:SOURce<hw>]:FREQuency:MODE <Mode>

The command sets the instrument operating mode and therefore also the commands used to set the output frequency.

Parameters:

<Mode>

CW | FIXed | SWEep | LIST

CW|FIXed

The instrument operates in fixed-frequency mode; CW and FIXed are synonyms. The output frequency is set with :SOURce:FREQuency:CW|FIXed.

SWEep

The instrument operates in SWEep mode. The frequency is set using the commands SOURce:FREQuency:START; STOP; CENTer; SPAN; MANual.

LIST

The instrument processes a list of frequency and level settings for the selected path.

The List mode settings are made in the [SOURce:LIST Subsystem](#). The setting SOURce:FREQuency:MODE LIST also sets the command SOURce:POWer:MODE automatically to LIST.

Correlation: FREQ:MODE LIST sets POW:MODE LIST

*RST: CW

- Example:** `FREQ:MODE SWE`
sets the SWEep mode. The settings under `SOURce:FREQuency:STARt; STOP; CENTer; SPAN; MANUal` become effective.
- Usage:** SCPI confirmed
- Manual control:** See "[State - Frequency Sweep](#)" on page 190

[[:SOURce<hw>]:FREQuency:MULTIplier <Multiplier>

The command sets the value for the multiplication factor of a subsequent downstream instrument.

Parameters:

<Multiplier> float
Range: 0.001 to (100 GHz / current RF frequency)
*RST: 1

Example: `FREQ:MULT 1`
sets the multiplication factor to 1.

Manual control: See "[Multiplier - RF Signal](#)" on page 118

[[:SOURce<hw>]:FREQuency:OFFSet <Offset>

The command sets the frequency offset of a downstream instrument, e.g. a mixer. If a frequency offset is entered, the frequency entered with `SOURce:FREQuency:...` no longer corresponds to the RF output frequency. The following correlation applies:

`SOURce:FREQuency:...` = RF output frequency + `SOURce:FREQuency:OFFSet`.

Entering an offset does not change the RF output frequency, but rather the query value of `SOURce:FREQuency:...`

Parameters:

<Offset> float
Range: -67GHz to 67GHz
Increment: 0.01Hz
*RST: 0Hz
Default unit: Hz

Example: `FREQ:OFFS 500kHz`
sets the frequency offset to 500 kHz.

Usage: SCPI confirmed

Manual control: See "[Offset - RF Signal](#)" on page 117

[[:SOURce<hw>]:FREQuency:PHASe:CONTInuous:HIGH?

Queries the maximum frequency of the frequency range for phase continuous settings.

The maximum frequency of the frequency range depends on the mode selected with the command `SOURce:FREQuency:PHASe:CONTInuous:MODE`.

Return values:

<High> float
 Range: 1E5 to 6E9
 Increment: 0.01Hz
 *RST: 1E9
 Default unit: Hz

Example: `FREQ:PHAS:CONT:MODE NARR`
 selects mode narrow.
`FREQ:PHAS:CONT:HIGH`
 queries the max frequency.

Example: Response: 1 003 720 930.23

Usage: Query only

Options: R&S SMx-B22

Manual control: See "[Frequency Range in \[Hz\] - RF Signal](#)" on page 123

[[:SOURce<hw>]:FREQuency:PHASe:CONTInuous:LOW?

Queries the minimum frequency of the frequency range for for phase continuous settings.

The minimum frequency of the frequency range depends on the mode selected with the command `SOURce:FREQuency:PHASe:CONTInuous:MODE`.

Return values:

<Low> float
 Range: 1E5 to 6E9
 Increment: 0.01Hz
 *RST: 1E9
 Default unit: Hz

Example: `FREQ:PHAS:CONT:MODE NARR`
 selects mode narrow.
`FREQ:PHAS:CONT:LOW`
 queries the max frequency.
 Response: 998 720 930.20

Usage: Query only

Options: R&S SMx-B22

Manual control: See "[Frequency Range in \[Hz\] - RF Signal](#)" on page 123

[[:SOURce<hw>]:FREQuency:PHASe:CONTInuous:MODE <Mode>

Selects the mode for determining the frequency range for the phase continuous signal (see [chapter 5.3.3.2, "Phase Continuous Frequency Setting"](#), on page 119).

The minimum and maximum frequency (`SOUR:FREQ:PHAS:CONT:HIGH` and `SOUR:FREQ:PHAS:CONT:LOW`) of the frequency range depends on the mode selected with this command.

Parameters:

<Mode> NARRow | WIDE

NARRow

The available frequency range is smaller than with setting wide. It is asymmetrical around the RF frequency set at the point of activating the phase continuous settings.

WIDE

The wide mode provides a larger frequency range. The frequency range is symmetrical around the RF frequency set at the point of activating the phase continuous settings.

*RST: NARRow

Example:

`FREQ:PHAS:CONT:MODE NARR`
selects narrow mode.

`FREQ:PHAS:CONT:LOW`
queries the max frequency.
Response: -3 518 518.52

Options: R&S SMx-B22

Manual control: See "[Frequency Range - RF Signal](#)" on page 122

[SOURce<hw>]:FREQuency:PHASe:CONTInuous:STATe <State>

Activates/deactivates phase continuous frequency settings. For a given RF frequency setting, phase continuous frequency changes are possible in a limited frequency range (see [chapter 5.3.3.2, "Phase Continuous Frequency Setting"](#), on page 119).

The output sinewave is phase continuous, i.e there will be no phase discontinuity or glitch when changing the frequency.

Note: Restricted structure of command line. As long as phase continuous mode is active, only one command in a command line is processed. A second command in the command line will be ignored.

Parameters:

<State> 0 | 1 | OFF | ON

*RST: OFF

Example:

`FREQ:PHAS:CONT:STAT ON`
activates phase continuous mode.

Manual control: See "[Phase Continuous Active](#)" on page 122

**[SOURce<hw>]:FREQuency:SPAN **

This command specifies the span for the sweep. This setting in combination with the center frequency setting (`[SOUR]:FREQ:CENT`) defines the sweep range.

This command is linked to the commands `[SOUR]:FREQ:STAR` and `[SOUR]:FREQ:STOP`, i.e. changing these values causes the `SPAN` value to change, and vice versa:

$$\text{SPAN} = (\text{STOP} - \text{START})$$

Negative values for `SPAN` are permitted; `START > STOP` then applies.

Parameters:

 float
 Range: 0 to RFmax
 Increment: 0.01Hz
 *RST: 400MHz

Example:

`FREQ:CENt 400 MHz`
 sets the center frequency of the frequency sweep to 400 MHz.
`FREQ:SPAN 200 MHz`
 sets a span of 200 MHz. This sets the sweep range to 300 MHz to 500 MHz.

Usage: SCPI confirmed

Manual control: See "[Span - Frequency Sweep](#)" on page 194

[SOURce<hw>]:FREQuency:STARt <Start>

This command sets the start frequency for the sweep mode. `START` can be greater than `STOP`.

This command is linked to the commands `[SOUR]:FREQ:CENt` and `[SOUR]:FREQ:SPAN`, i.e. changing these values causes the `START` value to change, and vice versa:

$$\text{START} = (\text{CENTer} - \text{SPAN}/2).$$

As with the "Frequency" value entered in the header, the `OFFSet` value is also taken into consideration with this command. The specified value range is therefore only effective if `OFFSet` is set to 0. The value range for other `OFFSet` values can be calculated using the following formula:

$$300 \text{ kHz} + \text{OFFSet} \dots \text{RF}_{\text{max}} + \text{OFFSet}$$

Parameters:

<Start> float
 Range: RFmin to RFmax (depending on the model)
 Increment: 0.01 Hz
 *RST: 100 MHz

Example:

`FREQ:STARt 1 MHz`
 sets the start frequency for the frequency sweep to 1 MHz.
`FREQ:STOP 2 GHz`
 sets the stop frequency for the frequency sweep to 2 GHz.

Manual control: See "[Start Freq - Frequency Sweep](#)" on page 194

[:SOURce<hw>]:FREQUENCY:STOP <Stop>

This command sets the stop frequency for the sweep mode. `STOP` can be less than `START`.

This command is linked to the commands `[:SOUR] :FREQ:CENT` and `[:SOUR] :FREQ:SPAN`, i.e. changing these values causes the `START` value to change, and vice versa:

$$\text{STOP} = (\text{CENTer} + \text{SPAN}/2)$$

As with the "Frequency" value entered in the header, the `OFFSet` value is also taken into consideration with this command. The specified value range is therefore only effective if `OFFSet` is set to 0. The value range for other `OFFSet` values can be calculated using the following formula:

$$300 \text{ kHz} + \text{OFFSet} \dots \text{RF}_{\text{max}} + \text{OFFSet}$$

Parameters:

`<Stop>` float
 Range: RFmin to RFmax (depending on the model)
 Increment: 0.01Hz
 *RST: 500 MHz
 Default unit: Hz

Example:

`FREQ:STOP 2 GHz`
 sets the stop frequency for the frequency sweep to 2 GHz.
`FREQ:STAR 1 MHz`
 sets the start frequency for the frequency sweep to 1 MHz.

Manual control: See ["Stop Freq - Frequency Sweep"](#) on page 194

[:SOURce<hw>]:FREQUENCY:STEP[:INCRement] <Increment>

The command sets the step width for the frequency setting if the frequency values `UP/DOWN` are used and variation mode `SOUR:FREQ:STEP:MODE USER` is selected. The command is linked to "Variation Step" for manual control, i.e. the command also sets the step width of the rotary knob for "Variation Active" on.

Parameters:

`<Increment>` float
 Range: 0 Hz to RFmax - xx kHz (depending on model)
 Increment: 0.01 Hz
 *RST: 1 MHz

Example:

`FREQ:STEP 50 kHz`
 sets the step width for the frequency setting to 50 kHz.

Manual control: See ["Variation Step - RF Signal"](#) on page 118

[[:SOURce<hw>]:FREQuency:STEP:MODE <Mode>

This command activates (USER) or deactivates (DECimal) the user-defined step width used when varying the frequency value with the frequency values UP/DOWN. The command is linked to the command "Variation Active" for manual control, i.e. the command also activates/deactivates the user-defined step width used when varying the frequency value with the rotary knob.

Parameters:

<Mode> DECimal | USER
*RST: DECimal

Example:

```
FREQ:STEP 50 kHz
sets the step width for the frequency setting to 50 kHz.
FREQ:STEP:MODE USER
activates this step width for frequency variation with the rotary knob
(manual control) and with frequency values UP/DOWN (remote
control).
```

Manual control: See "[Variation Active - RF Signal](#)" on page 118

7.13.8 SOURce:ILS Subsystem

The ILS subsystem contains the commands for checking the ILS-GS and ILS-LOC modulation. The AM-specific characteristics of the internal modulation source are defined with commands SOURce:ILS: . . . Characteristics which are valid for all modulations and the LF Output are configured in the SOURce:LFOuTput subsystem. The external signal is input at the AM EXT connector.



Commands [SOURce:] ILS[:GS|GSLope]:SODepth,
[SOURce:] ILS:LOCAlizer:SODepth,
[SOURce:] ILS:TYPE and [SOURce:] ILS:STATe are implemented for reasons of compatibility to R&S SMT signal generator family.

[[:SOURce]:ILS:LOCAlizer:COMid:CODE.....	510
[[:SOURce]:ILS:LOCAlizer:COMid:DASH.....	511
[[:SOURce]:ILS:LOCAlizer:COMid:DEPT.....	511
[[:SOURce]:ILS:LOCAlizer:COMid:DOT.....	512
[[:SOURce]:ILS:LOCAlizer:COMid:FREQuency.....	512
[[:SOURce]:ILS:LOCAlizer:COMid:LETTer.....	512
[[:SOURce]:ILS:LOCAlizer:COMid:PERiod.....	513
[[:SOURce]:ILS:LOCAlizer:COMid[:STATe].....	513
[[:SOURce]:ILS:LOCAlizer:COMid:SYMBol.....	514
[[:SOURce]:ILS:LOCAlizer:COMid:TSCHEMA.....	514
[[:SOURce]:ILS[:GS GSLope]:DDM:COUPling.....	515
[[:SOURce]:ILS:LOCAlizer:DDM:COUPling.....	515
[[:SOURce]:ILS[:GS GSLope]:DDM:CURRent.....	515
[[:SOURce]:ILS:LOCAlizer:DDM:CURRent.....	515
[[:SOURce]:ILS[:GS GSLope]:DDM[:DEPT].....	515

<code>[:SOURce]:ILS:LOCalizer:DDM[:DEPTH]</code>	515
<code>[:SOURce]:ILS[:GS GSLope]:DDM:DIRectio</code>	516
<code>[:SOURce]:ILS:LOCalizer:DDM:DIRectio</code>	516
<code>[:SOURce]:ILS[:GS GSLope]:DDM:LOGarithmic</code>	517
<code>[:SOURce]:ILS:LOCalizer:DDM:LOGarithmic</code>	517
<code>[:SOURce]:ILS[:GS GSLope]:DDM:PCT</code>	517
<code>[:SOURce]:ILS:LOCalizer:DDM:PCT</code>	517
<code>[:SOURce]:ILS[:GS GSLope]:DDM:POLarity</code>	518
<code>[:SOURce]:ILS:LOCalizer:DDM:POLarity</code>	518
<code>[:SOURce]:ILS[:GS GSLope]:FREQuency:STEP</code>	518
<code>[:SOURce]:ILS:LOCalizer:FREQuency:STEP</code>	518
<code>[:SOURce]:ILS[:GS GSLope]:ICAO:CHANnel</code>	519
<code>[:SOURce]:ILS:LOCalizer:ICAO:CHANnel</code>	519
<code>[:SOURce]:ILS[:GS GSLope]:LLOBe[:FREQuency]</code>	519
<code>[:SOURce]:ILS:LOCalizer:LLOBe[:FREQuency]</code>	519
<code>[:SOURce]:ILS[:GS GSLope]:MODE</code>	520
<code>[:SOURce]:ILS:LOCalizer:MODE</code>	521
<code>[:SOURce]:ILS[:GS GSLope]:PHASe</code>	521
<code>[:SOURce]:ILS:LOCalizer:PHASe</code>	521
<code>[:SOURce]:ILS[:GS GSLope]:PRESet</code>	522
<code>[:SOURce]:ILS:LOCalizer:PRESet</code>	522
<code>[:SOURce]:ILS:LOCalizer:RLOBe[:FREQuency]</code>	522
<code>[:SOURce]:ILS[:GS GSLope]:SDM</code>	523
<code>[:SOURce]:ILS:LOCalizer:SDM</code>	523
<code>[:SOURce]:ILS[:GS GSLope]:SOURce</code>	523
<code>[:SOURce]:ILS:LOCalizer:SOURce</code>	523
<code>[:SOURce]:ILS[:GS GSLope]:STATe</code>	524
<code>[:SOURce]:ILS:LOCalizer:STATe</code>	524
<code>[:SOURce]:ILS[:GS GSLope]:ULOBe[:FREQuency]</code>	524

`[:SOURce]:ILS:LOCalizer:COMid:CODE` <Code>

The command enters the coding of the COM/ID signal by the international short name of the airport (e.g. MUC for the Munich airport).

The COM/ID tone is sent according to the selected code (see [table 5-11](#)). If no coding is entered, the COM/ID tone is sent uncoded (key down).

The length of the morse code can be varied. For selection standard time scheme (`ILS:LOC:COM:TSCH STD`), the selected dot length determines the setting of all other length parameters of the morse code (dash length, symbol space and letter space). For selection user time scheme (`ILS:LOC:COM:TSCH USER`), all length parameters of the code can be set independently.

Parameters:

<Code> string

Example: `ILS:LOC:COM:CODE 'MUC'`
select COM/ID code for Munich airport.

Usage: SCPI confirmed

Options: Option R&S SMA-K25

Manual control: See ["COM/ID Code - ILS-LOC Modulation"](#) on page 277

[[:SOURce]:ILS:LOCalizer:COMid:DASH <Dash>

Enters the length of a morse dash by means of seconds. This command is available for user time schema only.

Parameters:

<Dash> float
 Range: 50 ms to 1 s
 Increment: 0.1 ms
 *RST: 300 ms
 Default unit: ms

Example:

```
ILS:LOC:COM:CODE 'MUC'
selects code for Munich airport
ILS:LOC:COM:TSCH USER
selects user time schema
ILS:LOC:COM:DOT 200ms
sets a dot length of 200 ms.
ILS:LOC:COM:DASH 400ms
sets a dash length of 400 ms.
ILS:LOC:COM:LETT 50ms
sets a letter space of 50 ms.
ILS:LOC:COM:SYMB 10ms
sets a symbol space of 10 ms.
```

Options: Option R&S SMA-K25

Manual control: See ["COM/ID Dash Length - ILS-LOC Modulation"](#) on page 279

[[:SOURce]:ILS:LOCalizer:COMid:DEPTH <Depth>

The command sets the frequency of the communication/identification signal.

Parameters:

<Depth> float
 Range: 0 to 100
 Increment: 0.1
 *RST: 95
 Default unit: PCT

Example:

```
ILS:LOC:COM:DEPT 10 PCT
sets the AM depth of the communication/identification signal to the
value of 10 PCT.
```

Options: Option R&S SMA-K25

Manual control: See ["COM/ID Depth - ILS-LOC Modulation"](#) on page 279

[[:SOURce]:ILS:LOCalizer:COMid:DOT <Dot>

Enters the length of a morse dot by means of seconds. The length of the dash (3xdot), space (=dot) and letter space (=3xdot) is also determined by this entry.

Parameters:

<Dot> float
 Range: 50 ms to 1 s
 Increment: 0.1 ms
 *RST: 100 ms
 Default unit: ms

Example:

ILS:LOC:COM:CODE 'MUC'
 selects code for Munich airport
 ILS:LOC:COM:DOT 200ms
 sets a dot length of 200 ms.

Options:

Option R&S SMA-K25

Manual control:

See "[COM/ID Dot Length - ILS-LOC Modulation](#)" on page 279

[[:SOURce]:ILS:LOCalizer:COMid:FREQUency <Frequency>

The command sets the frequency of the additional communication/identification signal.

Parameters:

<Frequency> float
 Range: 0.1 to 20000
 Increment: 0.1
 *RST: 1020
 Default unit: Hz

Example:

ILS:LOC:COM:FREQ 1020
 sets the frequency of the identification signal to the standard value of 1020 Hz.

Options:

Option R&S SMA-K25

Manual control:

See "[COM/ID Frequency - ILS-LOC Modulation](#)" on page 278

[[:SOURce]:ILS:LOCalizer:COMid:LETTER <Letter>

Enters the length of a letter space by means of seconds. This command is available for user time schema only.

Parameters:

<Letter> float
 Range: 50 ms to 1 s
 Increment: 0.1 ms
 *RST: 300 ms
 Default unit: ms

Example:

```

ILS:LOC:COM:CODE 'MUC'
selects code for Munich airport
ILS:LOC:COM:TSCHE USER
selects user time schema
ILS:LOC:COM:DOT 200ms
sets a dot length of 200 ms.
ILS:LOC:COM:DASH 400ms
sets a dash length of 400 ms.
ILS:LOC:COM:LETT 50ms
sets a letter space of 50 ms.
ILS:LOC:COM:SYMB 10ms
sets a symbol space of 10 ms.

```

Options: Option R&S SMA-K25

Manual control: See ["COM/ID Letter Space - ILS-LOC Modulation"](#) on page 279

[[:SOURce]:ILS:LOCalizer:COMid:PERiod <Period>

Enters the period of the COM/ID signal in seconds.

Parameters:

```

<Period>          float
                   Range:    0 ms to 120 s
                   Increment: 1 ms
                   *RST:     9 s

```

Example:

```

ILS:LOC:COM:PER 888ms
sets a period of 888 ms for the COM/ID signal.

```

Options: Option R&S SMA-K25

Manual control: See ["COM/ID Period - ILS-LOC Modulation"](#) on page 278

[[:SOURce]:ILS:LOCalizer:COMid[:STATe] <State>

The command activates or deactivates the additional communication/identification signal.

Parameters:

```

<State>          0 | 1 | OFF | ON
                   *RST:    OFF

```

Example:

```

ILS:LOC:COM ON
activates the COM/ID signal.

```

Options: Option R&S SMA-K25

Manual control: See ["COM/ID State - ILS-LOC Modulation"](#) on page 277

[[:SOURce]:ILS:LOCalizer:COMid:SYMBol <Symbol>

Enters the length of the symbol space by means of seconds. This command is available for user time schema only.

Parameters:

<Symbol> float
 Range: 50 ms to 1 s
 Increment: 0.1 ms
 *RST: 100 ms
 Default unit: ms

Example:

```
ILS:LOC:COM:CODE 'MUC'
selects code for Munich airport
ILS:LOC:COM:TSCH USER
selects user time schema
ILS:LOC:COM:DOT 200ms
sets a dot length of 200 ms.
ILS:LOC:COM:DASH 400ms
sets a dash length of 400 ms.
ILS:LOC:COM:LETT 50ms
sets a letter space of 50 ms.
ILS:LOC:COM:SYMB 10ms
sets a symbol space of 10 ms.
```

Options: Option R&S SMA-K25

Manual control: See ["COM/ID Symbol Space - ILS-LOC Modulation"](#) on page 279

[[:SOURce]:ILS:LOCalizer:COMid:TSCHema <TSchema>

Selects if the set dot length determines the dash length (= three times the dot length) (setting STD) or if all length parameters can be set independently (setting USER). (COM/ID signal).

Parameters:

<TSchema> STD | USER
 *RST: STD

Example:

```
ILS:LOC:COM:CODE 'MUC'
selects code for Munich airport
ILS:LOC:COM:TSCH STD
selects standard time schema
ILS:LOC:COM:DOT 200ms
sets a dot length of 200 ms. The dash length and letter space is 3
x dot length, the symbol space equals the dot length.
```

Options: Option R&S SMA-K25

Manual control: See ["COM/ID Time Schema - ILS-LOC Modulation"](#) on page 279

```
[:SOURce]:ILS[:GS|GSLope]:DDM:COUPling <Coupling>
[:SOURce]:ILS:LOCAlizer:DDM:COUPling <Coupling>
```

Selects if the DDM value is fixed or is changed with a change of sum of modulation depths (SDM, see [\[:SOURce\]:ILS:LOCAlizer:SDM](#) on page 523).

Parameters:

<Coupling> FIXed | SDM
*RST: FIXed

Example:

```
ILS:DDM:COUP SDM
```

the absolute value of DDM changes with changes of the SDM value. The DDM value expressed in dB stays constant.

Options: Option R&S SMA-K25

Manual control: See "[DDM - SDM Coupling - ILS-LOC Modulation](#)" on page 275

```
[:SOURce]:ILS[:GS|GSLope]:DDM:CURRent <Current>
[:SOURce]:ILS:LOCAlizer:DDM:CURRent <LocCurrent>
```

The command enters the DDM value alternatively as a current by means of the ILS indicating instrument. The instrument current is calculated according to:

$$\text{DDM } \mu\text{A} = \text{DDM} \times 857,1 \mu\text{A}$$

A variation of the instrument current automatically leads to a variation of the DDM value and the DDM value in dB

Parameters:

<LocCurrent> float
Range: -967.75 μ A to 967.75 μ A
Increment: 1E-7
*RST: 0 μ A
Default unit: A

<GsCurrent> float
Range: -857.125 μ A to 857.12 μ A
*RST: 0 μ A
Default unit: A

Example:

```
ILS:DDM:CURR?
```

queries the instrument current (ILS-GS modulation).

Options: Option R&S SMA-K25

Manual control: See "[DDM Current - ILS-LOC Modulation](#)" on page 274

```
[:SOURce]:ILS[:GS|GSLope]:DDM[:DEPTh] <Depth>
[:SOURce]:ILS:LOCAlizer:DDM[:DEPTh] <Depth>
```

The command enters the difference in depth of modulation between the signal of the upper/left lobe (90 Hz) and the lower/right lobe (150 Hz). The maximum value equals the sum of the modulation depths of the 90 Hz and the 150 Hz tone. The following is true:

`ILS:GS|LOC:DDM:DEPTH = (AM(90Hz) - AM(150Hz))/100%`

A variation of the DDM value automatically leads to a variation of the DDM value in dB and the value of the instrument current.

Parameters:

<Depth> float
 Range: -0.4 to 0.4
 Increment: 0.0001
 *RST: 0

Example:

`ILS:DDM 0.2`
 sets the difference in depth of modulation to 20 percent between the signal of the upper lobe (90 Hz) and the lower lobe (150 Hz) in ILS-GS modulation.

Options: Option R&S SMA-K25

Manual control: See "[DDM Depth - ILS-LOC Modulation](#)" on page 274

`[:SOURce]:ILS[:GS|GSLope]:DDM:DIRection <Direction>`

`[:SOURce]:ILS:LOCalizer:DDM:DIRection <LocDirection>`

Selects the simulation mode for the ILS-GS / ILS-LOC modulation signal. A change of the setting automatically changes the sign of the DDM value

Parameters:

<LocDirection> LEFT | RIGHT
LEFT
 The 150-Hz modulation signal is predominant, the DDM value is negative (the airplane is too far to the right, it must turn to the left).
RIGHT (ILS-LOC)
 The 90-Hz modulation signal is predominant, the DDM value is positive (the airplane is too far to the left, it must turn to the right).
 *RST: LEFT

<GsDirection> UP | DOWN
UP
 The 150-Hz modulation signal is predominant, the DDM value is negative (the airplane is too low, it must climb).
DOWN
 The 90-Hz modulation signal is predominant, the DDM value is positive (the airplane is too high, it must descend).
 *RST: UP

Example:

`ILS:DDM:DIR UP`
 'The airplane is too low, it must climb.

Options: Option R&S SMA-K25

Manual control: See "[Fly - ILS-LOC Modulation](#)" on page 274

```
[:SOURce]:ILS[:GS|GSLope]:DDM:LOGarithmic <Logarithmic>
[:SOURce]:ILS:LOCalizer:DDM:LOGarithmic <Logarithmic>
```

The command enters the DDM value in dB. The dB value is calculated according to:

$$\text{DDM dB} = 20 \times \text{LOG} \left[\frac{(\text{SDM} + \text{DDM} \times 100\%)}{(\text{SDM} - \text{DDM} \times 100\%)} \right]$$

A variation of the value automatically leads to a variation of the DDM value and the instrument current.

Parameters:

<Logarithmic> float
 Range: -999.9 to 999.9
 Increment: 1E-4
 *RST: 0
 Default unit: dB

Example:

```
ILS:DDM:LOG 1
```

sets the difference in depth of modulation to 1 dB between the signal of the upper lobe (90 Hz) and the lower lobe (150 Hz) in ILS-GS modulation.

Options:

Option R&S SMA-K25

Manual control:

See "[DDM Logarithmic - ILS-LOC Modulation](#)" on page 274

```
[:SOURce]:ILS[:GS|GSLope]:DDM:PCT <Pct>
[:SOURce]:ILS:LOCalizer:DDM:PCT <Pct>
```

The command enters the difference in depth of modulation between the signal of the upper/left lobe (90 Hz) and the lower/right lobe (150 Hz). The maximum value equals the sum of the modulation depths of the 90 Hz and the 150 Hz tone. The following is true for the percentage value:

$$\text{ILS:GS|LOC:DDM:DEPT}h = (\text{AM}(90\text{Hz}) - \text{AM}(150\text{Hz}))$$

A variation of the DDM value automatically leads to a variation of the DDM value in dB and the value of the instrument current.

Parameters:

<Pct> float
 Range: -80.0 to 80.0
 Increment: 0.01
 *RST: 0

Example:

```
ILS:DDM 20
```

sets the difference in depth of modulation to 20 percent between the signal of the upper lobe (90 Hz) and the lower lobe (150 Hz) in ILS-GS modulation.

Manual control:

See "[DDM Percent - ILS-LOC Modulation](#)" on page 275

```
[:SOURce]:ILS[:GS|GSLope]:DDM:POLarity <Polarity>
[:SOURce]:ILS:LOCalizer:DDM:POLarity <Polarity>
```

The command enters the polarity for DDM calculation (see [\[:SOURce\]:ILS:LOCalizer:DDM\[:DEPTh\]](#) on page 515).

The DDM depth calculation depends on the selected polarity:

- Polarity 90 Hz - 150 Hz (default setting):
DDM = [AM(90 Hz) - AM (150 Hz)] / 100%
- Polarity 150 Hz - 90 Hz:
DDM = [AM(150 Hz) - AM (90 Hz)] / 100%

Parameters:

```
<Polarity>          P90_150 | P150_90
*RST:               P90_150
```

Example: `ILS:DDM:POL P90_150`
selects polarity 90 Hz - 150 Hz

Options: Option R&S SMA-K25

Manual control: See ["DDM Polarity- ILS-LOC Modulation"](#) on page 273

```
[:SOURce]:ILS[:GS|GSLope]:FREQuency:STEP <Step>
[:SOURce]:ILS:LOCalizer:FREQuency:STEP <Step>
```

The command selects the variation of the carrier frequency via the rotary knob.

Parameters:

```
<Step>              DECimal | ICAO
```

DECimal

Decimal variation according to the current cursor position.

ICAO

Variation in predefined steps according to the standardized ILS-GS/LOC transmitting frequencies. The start value can be selected with command `ILS:GS|LOC:ICAO:CHANnel`. The selection of the ICAO channel is effective on both ILS modulations. A switch between the two modulations causes the RF frequency to be adapted to the associated value.

```
*RST:               DECimal
```

Example: `ILS:FREQ:STEP DEC`
selects decimal variation (ILS-GS modulation).

Options: Option R&S SMA-K25

Manual control: See ["Carrier Frequency Step - ILS-LOC Modulation"](#) on page 280

```
[[:SOURce]:ILS[:GS|GSLope]:ICAO:CHANnel <Channel>
[:SOURce]:ILS:LOCalizer:ICAO:CHANnel <Channel>
```

The command selects the ICAO channel i.e., the ILS transmitting frequency. The RF-frequency is set to the value selected here. A variation of the carrier frequency by the rotary knob is performed in predefined steps according to the standardized ILS transmitting frequencies (see [table 5-12](#)). The ICAO channel settings for ILS-GS and ILS-LOC are coupled.

Parameters:

```
<Channel>          CH18X | CH18Y | CH20X | CH20Y | CH22X | CH22Y | CH24X |
                   CH24Y | CH26X | CH26Y | CH28X | CH28Y | CH30X | CH30Y |
                   CH32X | CH32Y | CH34X | CH34Y | CH36X | CH36Y | CH38X |
                   CH38Y | CH40X | CH40Y | CH42X | CH42Y | CH44X | CH44Y |
                   CH46X | CH46Y | CH48X | CH48Y | CH50X | CH50Y | CH52X |
                   CH52Y | CH54X | CH54Y | CH56X | CH56Y
*RST:              18X
```

Example:

```
ILS:ICAO:CHAN CH18X
```

selects ICAO frequency channel 18X. This channel sets the RF frequency to 334.7 MHz for ILS-GS and 108.1 MHz for ILS-LOC.

Options: Option R&S SMA-K25

Manual control: See "[ICAO Channel - ILS-LOC Modulation](#)" on page 281

```
[[:SOURce]:ILS[:GS|GSLope]:LLOBe[:FREQUENCY] <Frequency>
```

The command enters the modulation frequency of the antenna lobe arranged at the bottom viewed from the air plane.

Parameters:

```
<Frequency>       float
Range:            100 to 200
Increment:       0.5
*RST:            150
Default unit:    Hz
```

Example:

```
ILS:LLOB 150
```

sets the frequency of the antenna lobe at the bottom of the air plane to the standard value 150 Hz (ILS-GS modulation).

Options: Option R&S SMA-K25

Manual control: See "[Down Frequency - ILS-GS Modulation](#)" on page 269

```
[[:SOURce]:ILS:LOCalizer:LLOBe[:FREQUENCY] <Frequency>
```

The command enters the modulation frequency of the antenna lobe arranged at the bottom viewed from the air plane.

Parameters:

<Frequency> float
 Range: 60 to 120
 Increment: 0.3
 *RST: 90
 Default unit: Hz

Example:

ILS:LOC:LLOB 90
 sets the frequency of the antenna lobe to the left of the air plane to the standard value 90 Hz (ILS-LOC modulation).

Options:

Option R&S SMA-K25

Manual control:

See "[Left Frequency - ILS-LOC Modulation](#)" on page 276

[[:SOURce]:ILS[:GS|GSLope]:MODE <Mode>

Selects the operating mode for the ILS-GS modulation signal.

Parameters:

<Mode> NORM | ULOBe | LLOBe

NORM

ILS-GS modulation is active.

ULOBe

Amplitude modulation of the output signal with the upper lobe (90Hz) signal component of the ILS-GS signal is active. The modulation depth of the 90Hz signal results from the settings of commands SOURce:ILS:GS:SDM and

SOURce:ILS:GS:DDM[:DEPT] according to (command SOURce:ILS:GS:DDM:DIR UP):

$AM(90Hz) = 0.5 * (ILS:GS:SDM + ILS:GS:DDM * 100\%)$

and for SOURce:ILS:GS:DDM:DIR DOWN according to

$AM(90Hz) = 0.5 * (ILS:GS:SDM - ILS:GS:DDM * 100\%)$

LLOBe

Amplitude modulation of the output signal with the lower lobe (150Hz) signal component of the ILS-GS signal is active. The modulation depth of the 150Hz signal results from the settings of commands SOURce:ILS:GS:SDM and

SOURce:ILS:GS:DDM[:DEPT] according to (command SOURce:ILS:GS:DDM:DIR UP):

$AM(150Hz) = 0.5 * (ILS:GS:SDM + ILS:GS:DDM * 100\%)$

and for SOURce:ILS:GS:DDM:DIR DOWN according to

$AM(150Hz) = 0.5 * (ILS:GS:SDM - ILS:GS:DDM * 100\%)$

*RST: NORM

Example:

ILS:MODE ULOB

Activates amplitude modulation of the output signal with the upper lobe (90Hz) signal component of the ILS-GS signal.

Options:

Option R&S SMA-K25

Manual control: See ["Mode - ILS-GS Modulation"](#) on page 269

[[:SOURce]:ILS:LOCalizer:MODE <Mode>

Selects the operating mode for the ILS-LOC modulation signal.

Parameters:

<Mode>

NORM | LLOBe | RLOBe

NORM

ILS-LOC modulation is active.

LLOBe

Amplitude modulation of the output signal with the left lobe (90Hz) signal component of the ILS-LOC signal is active. The modulation depth of the 90Hz signal results from the settings of commands

SOURce:ILS:LOC:SDM and

SOURce:ILS:LOC:DDM[:DEPTH] according to (command SOURce:ILS:LOC:DDM:DIR RIGHT):

$AM(90Hz) = 0.5 * (ILS:LOC:SDM + ILS:LOC:DDM * 100\%)$

and for SOURce:ILS:GS:DDM:DIR LEFT according to

$AM(90Hz) = 0.5 * (ILS:LOC:SDM - ILS:LOC:DDM * 100\%)$

RLOBe

Amplitude modulation of the output signal with the right lobe (150Hz) signal component of the ILS-LOC signal is active. The modulation depth of the 150Hz signal results from the settings of commands SOURce:ILS:LOC:SDM and

SOURce:ILS:LOC:DDM[:DEPTH] according to (command SOURce:ILS:LOC:DDM:DIR RIGHT):

$AM(150Hz) = 0.5 * (ILS:LOC:SDM + ILS:LOC:DDM * 100\%)$

and for SOURce:ILS:GS:DDM:DIR LEFT according to

$AM(150Hz) = 0.5 * (ILS:LOC:SDM - ILS:LOC:DDM * 100\%)$

*RST: NORM

Example:

ILS:LOC:MODE LLOB

Activates amplitude modulation of the output signal with the left lobe (90Hz) signal component of the ILS-LOC signal.

Options:

Option R&S SMA-K25

Manual control:

See ["Mode - ILS-LOC Modulation"](#) on page 275

[[:SOURce]:ILS[:GS|GSLope]:PHASe <Phase>

[[:SOURce]:ILS:LOCalizer:PHASe <Phase>

The command enters the phase between the modulation signals of the upper/left and lower/right antenna lobe. The zero crossing of the lower/right lobe (150Hz) signal serves as a reference. The angle refers to the period of the signal of the lower/right antenna lobe.

Parameters:

<Phase> float
 Range: -60 to 120
 Increment: 0.01
 *RST: 0
 Default unit: DEG

Example:

```
ILS:LOC:PHAS 30DEG
```

sets the phase between the modulation signals of the left and right antenna lobe to 30 degrees (ILS-LOC modulation).

Options:

Option R&S SMA-K25

Manual control:

See "[Left/Right Phase - ILS-LOC Modulation](#)" on page 276

```
[:SOURce]:ILS[:GS|GSLope]:PRESet
```

```
[:SOURce]:ILS:LOCALizer:PRESet
```

The commands activate the ILS-GS /ILS-LOC default setting.

Example:

```
ILS:LOC:PRES
```

activates the ILS-LOC default settings for all SOURCE:ILS:LOC:... commands.

Usage:

Event
 SCPI confirmed

Options:

Option R&S SMA-K25

Manual control:

See "[Set to Default - ILS-LOC Modulation](#)" on page 276

```
[:SOURce]:ILS:LOCALizer:RLOBe[:FREQUENCY] <Frequency>
```

The command enters the modulation frequency of the antenna lobe arranged at the right viewed from the air plane.

Parameters:

<Frequency> float
 Range: 100 to 200
 Increment: 0.5
 *RST: 150
 Default unit: Hz

Example:

```
ILS:LOC:RLOB 150
```

sets the frequency of the antenna lobe at the right of the air plane to the standard value 150 Hz (ILS-LOC modulation).

Options:

Option R&S SMA-K25

Manual control:

See "[Right Frequency - ILS-LOC Modulation](#)" on page 276

```
[:SOURce]:ILS[:GS|GSLope]:SDM <Sdm>
[:SOURce]:ILS:LOCALizer:SDM <Sdm>
```

The commands enter the arithmetic sum of the modulation depths of the upper/left lobe (90Hz) and lower/right lobe (150Hz) ILS-GS/ILS-LOC signal contents. The RMS modulation depth of the sum signal depends on the phase setting of both modulation tones.

Note:

Commands [SOURce:] ILS[:GS|GSLope]:SODepth and [SOURce:] ILS:LOCALizer:SODepth are implemented as alias commands.

Parameters:

<LocSdm> float
 Range: 0 to 100
 Increment: 0.1
 *RST: 40
 Default unit: PCT

<GsSdm> float
 Range: 0 to 100
 Increment: 0.1
 *RST: 80
 Default unit: PCT

Example: ILS:SDM 80PCT
 sets a sum of modulation depths of 80 % for the upper lobe (90Hz) and lower lobe (150Hz) ILS-GS signal.

Options: Option R&S SMA-K25

Manual control: See ["Sum of Depth - ILS-LOC Modulation"](#) on page 274

```
[:SOURce]:ILS[:GS|GSLope]:SOURce <Source>
[:SOURce]:ILS:LOCALizer:SOURce <Source>
```

The command selects the modulation source for ILS-GS and ILS-LOC modulation. INT is the internal modulation source. The external signal is input at the AM EXT connector. The external signal is added to the internal signal. Switching off the internal source is not possible.

Parameters:

<Source> INT | INT,EXT | EXT
 *RST: INTERNAL

Example: ILS:SOUR INT
 selects the internal modulation source.

Options: Option R&S SMA-K25

Manual control: See ["EXT AM - ILS-LOC Modulation"](#) on page 282

```
[ :SOURce ] : ILS : GS | GS | Lope : STATe <State>
```

```
[ :SOURce ] : ILS : LOCalizer : STATe <State>
```

The commands activate/deactivate ILS-GS/ILS-LOC modulation.

Note: Commands [SOURce:] ILS:STATe and [SOURce:] ILS:TYPE are implemented for reasons of compatibility to R&S SMT(E) Signal Generator family.

Parameters:

```
<State>          0 | 1 | OFF | ON
                  *RST:      OFF
```

Example:

```
ILS:STAT ON
activates ILS-GS modulation.
ILS:LOC:STAT ON
activates ILS-LOC modulation. The RF-frequency is automatically
set to 190 kHz.
```

Options: Option R&S SMA-K25

Manual control: See "[State - ILS-LOC Modulation](#)" on page 273

```
[ :SOURce ] : ILS [ : GS | GS | Lope ] : ULOBe [ : FREQUency ] <Frequency>
```

The command enters the modulation frequency of the antenna lobe arranged at the top viewed from the air plane.

Parameters:

```
<Frequency>      float
                  Range:      60 to 120
                  Increment:  0.3
                  *RST:      90
                  Default unit: Hz
```

Example:

```
ILS:ULOB 90
sets the frequency of the antenna lobe at the top of the air plane
to the standard value 90 Hz (ILS-GS modulation).
```

Options: Option R&S SMA-K25

Manual control: See "[Up Frequency - ILS-GS Modulation](#)" on page 269

7.13.9 SOURce:INPut Subsystem

The SOURce:INPut subsystem contains the commands for configuring the inputs for external modulation signals. The instrument trigger setting influences all sweeps and is effective in the List mode (Instrument Trigger).

```
[ :SOURce<hw> ] : INPut : MODext : IMPedance ..... 525
[ :SOURce ] : INPut : TRIGger : SLOPe ..... 525
```

[[:SOURce<hw>]:INPut:MODext:IMPedance <Impedance>

This command sets the impedance for external feed via the FM/PM EXT input.

Parameters:

<Impedance> HIGH | G50
HIGH
 > 100 kOhm to ground
G50
 50 Ohm to ground
 *RST: HIGH

Example:

INP:MOD:IMP HIGH
 the EXT MOD input is set to > 100 kOhm to ground.

Manual control:

See "[External Input Impedance](#)" on page 222

[[:SOURce]:INPut:TRIGger:SLOPe <Slope>

Sets the polarity of the active slope of an externally applied trigger signal at the trigger input (BNC connector at the rear of the instrument).

The setting is effective for both inputs at the same time.

Parameters:

<Slope> NEGative | POSitive
 *RST: POSitive

Example:

INP:TRIG:SLOP NEG
 activates the falling slope of the external trigger signal at the trigger input.

Manual control:

See "[Trigger Input Slope](#)" on page 196

7.13.10 SOURce:LFOutput Subsystem

This subsystem contains the commands for setting the LF signal source in CW and Sweep mode as well as for analog modulation.

An LF generator is always available in the instrument. A second LF generator is optional.

The suffix for LFOutput<ch> denotes the selected LF generator. The source for the LF sweep (LF generator 1 or 2) is selected with command SOURce:LFOutput:SWEep:FREQuency:SOURce.

Example

The following example shows how to set an LF sweep.

1. Set the sweep range.

```
LFOutput:FREQuency:START 4 kHz
LFOutput:FREQuency:STOP 10 kHz
```

2. Select linear or logarithmic sweep spacing.
LFOutput:SWEep[:FREQuency]:SPACing LIN
3. Set the step width and dwell time.
LFOutput:SWEep[:FREQuency]:STEP[:LINear] 100 Hz
LFOutput:SWEep[:FREQuency]:DWELL 20 ms
4. Determine the sweep mode.
LFOutput:SWEep:MODE AUTO
5. Determine the trigger.
TRIGger0:SOURce SINGLE
6. Activate the sweep.
LFOutput:FREQuency:MODE SWEep
7. Trigger the sweep (depending on the mode).
LFOutput:SWEep:EXECute

[:SOURce]:LFOutput<ch>:FREQuency.....	526
[:SOURce]:LFOutput:FREQuency:MANual.....	527
[:SOURce]:LFOutput:FREQuency:MODE.....	527
[:SOURce]:LFOutput:FREQuency:STARt.....	528
[:SOURce]:LFOutput:FREQuency:STOP.....	529
[:SOURce]:LFOutput<ch>:INTernal:VOLtAge.....	529
[:SOURce]:LFOutput:OFFSet.....	529
[:SOURce]:LFOutput:SOURce.....	530
[:SOURce]:LFOutput[:STATe].....	530
[:SOURce]:LFOutput:SWEep[:FREQuency]:DWELL.....	530
[:SOURce]:LFOutput:SWEep[:FREQuency]:EXECute.....	530
[:SOURce]:LFOutput:SWEep[:FREQuency]:LFSource.....	531
[:SOURce]:LFOutput:SWEep[:FREQuency]:MODE.....	531
[:SOURce]:LFOutput:SWEep[:FREQuency]:POINTs.....	532
[:SOURce]:LFOutput:SWEep[:FREQuency]:SHAPE.....	533
[:SOURce]:LFOutput:SWEep[:FREQuency]:SPACing.....	533
[:SOURce]:LFOutput:SWEep[:FREQuency]:STEP[:LINear].....	533
[:SOURce]:LFOutput:SWEep[:FREQuency]:STEP:LOGarithmic.....	534
[:SOURce]:LFOutput<ch>:SHAPE.....	535
[:SOURce]:LFOutput<ch>:SHAPE:TRAPeZe:FALL.....	535
[:SOURce]:LFOutput<ch>:SHAPE:TRAPeZe:HIGH.....	535
[:SOURce]:LFOutput<ch>:SHAPE:TRAPeZe:LOW.....	536
[:SOURce]:LFOutput<ch>:SHAPE:TRAPeZe:RISE.....	536
[:SOURce]:LFOutput:VOLtAge.....	536

[:SOURce]:LFOutput<ch>:FREQuency <Frequency>

The command sets the frequency of the LF signal for CW mode (:SOUR:MODE CW). The setting is valid for all analog modulations (AM/FM/PhiM) with internal modulation source and for the LF Output.

If test signals for avionic systems are generated (VOR/ILS modulation), the frequency is preset and cannot be set.

In sweep mode (`SOUR:LFO:FREQ:MODE SWE`), the frequency is linked to the sweep frequency.

Correlation: `LFO:FREQ` for `LFO:FREQ:MODE SWE` linked to sweep frequency.

Parameters:

<Frequency> float
 Increment: 0.1 Hz
 *RST: 1KHz

Example: `LFO2:FREQ 5kHz`
 sets the frequency of the LF generator 2 signal to 5 kHz.

Options: Option R&S SMA-K24 is required for selection LFOOutput2.

Manual control: See "[LF Gen 1/2 Freq](#)" on page 217

[[:SOURce]:LFOOutput:FREQUENCY:MANual <Manual>

In Sweep mode (`SOUR:LFO:FREQ:MODE SWE`) the command sets the frequency for the next sweep step in the "Step" sweep mode (`SOUR:LFO:SWE:MODE MAN`). Here only frequency values between the settings `SOUR:LFO:FREQ:STAR` and `. . . :STOP` are permitted. Each sweep step is triggered by a separate `SOUR:LFO:FREQ:MAN` command.

Parameters:

<Manual> float
 Range: START to STOP
 Increment: 0.1 Hz
 *RST: 1 kHz

Example: `LFO:SWE:MODE MAN`
 sets the "Step" sweep mode.
`LFO:FREQ:MAN 5 kHz`
 sets an LF frequency of 5 kHz for the next step in the "Step" sweep mode.
`LFO:FREQ:MODE SWE`
 sets the LF Sweep mode. An LF frequency of 5 kHz is output.
`LFO:FREQ:MAN 5.1 kHz`
 triggers the next sweep step with a frequency of 5.1 kHz.

Manual control: See "[Current Freq - LF Sweep](#)" on page 295

[[:SOURce]:LFOOutput:FREQUENCY:MODE <Mode>

The command sets the instrument operating mode and therefore also the commands used to set the output frequency.

The source for the LF sweep is selected with command `[[:SOURce]:LFOOutput:SWEep[:FREQUENCY]:LFSource`.

Parameters:

<Mode>

CW | FIXed | SWEep

CW|FIXed

The instrument operates in fixed-frequency mode. CW and FIXed are synonyms.

The output frequency is set with `[:SOURce] :LFOutput<ch>:FREQuency`.

SWEep

The instrument operates in SWEep mode. The frequency is set using the commands `[:SOURce] :LFOutput:FREQuency:START`, `[:SOURce] :LFOutput:FREQuency:STOP` or `[:SOURce] :LFOutput:FREQuency:MANual`.

*RST: CW

Example:

LFO:FREQ:MODE SWE

sets the SWEep mode. The settings under

SOURce:LFOutput:FREQuency:START; STOP; MANual become effective.

Manual control:

See "State - LF Sweep" on page 292

[:SOURce] :LFOutput:FREQuency:STARt <Start>

This command sets the start frequency for the LF Sweep mode.

Parameters:

<Start>

float

Range: 0.1 Hz to 1 MHz

Increment: 0.1 Hz

*RST: 1 kHz

Example:

RST*

activates all presettings.

LFO:SWE:MODE AUTO

sets the AUTO sweep mode, i.e. each trigger triggers a complete sweep.

TRIG0:SOUR SING

sets the SINGLE trigger mode, i.e. the sweep is triggered by the command `:LFOutput:SWEep:EXECute` or `*TRG`.

LFO:FREQ:STAR 100 kHz

sets the start frequency for the LF sweep to 100 kHz.

LFO:FREQ:STOP 200 kHz

sets the stop frequency of the LF sweep to 200 kHz.

LFO:FREQ:MODE SWE

sets the LF sweep mode.

LFO:SWE:EXEC

a one-off LF sweep from 100 kHz to 200 kHz is performed. The linear step width is 1 kHz with a dwell time of 15 ms (preset values).

Manual control:

See "Start Freq - LF Sweep" on page 295

[[:SOURce]:LFOutput:FREQuency:STOP <Stop>

This command sets the stop frequency for the LF sweep.

Parameters:

<Stop> float
 Range: 0.1 Hz to 1 MHz
 Increment: 0.1 Hz
 *RST: 50 kHz

Example:

LFO:FREQ:STOP 200 kHz
 sets the stop frequency for the LF sweep to 200 kHz.
 LFO:FREQ:STAR 100 kHz
 sets the start frequency for the LF sweep to 100 kHz.

Manual control: See ["Stop Freq - LF Sweep"](#) on page 295

[[:SOURce]:LFOutput<ch>:INTernal:VOLTage <Voltage>

The command sets the output voltage for the two LF generators. The sum of the two values must not exceed the overall output voltage set with command `SOURce:LFOutput:VOLTage`.

Parameters:

<Voltage> float
 Range: 0.001 V to 4 V
 Increment: 0.001 V
 *RST: 0.5 V

Example:

LFO:INT:VOLT 0.5V
 sets the output voltage of the first LF generator to 0.5 volts

Usage: SCPI confirmed

Options: Option R&S SMA-K24 is required for selection LFOutput2

Manual control: See ["Output Voltage 1/2 - LF Output"](#) on page 299

[[:SOURce]:LFOutput:OFFSet <Offset>

The command sets a DC offset at the LF Output.

Parameters:

<Offset> float
 Range: -4 to 4 V
 Increment: 0.001 V
 *RST: 0 V

Example:

LFO:OFFS 2 V
 sets a DC OFFSet of 2 V

Usage: SCPI confirmed

Manual control: See ["DC Offset - LF Output"](#) on page 300

[[:SOURce]:LFOutput:SOURce <Source>

The command selects the internal source to be used for the LF Output signal. The available selection depends on the options fitted.

If test signals for avionic systems are generated (VOR/ILS modulation), the sources are preset and cannot be changed.

Parameters:

<Source> LF1 | LF2 | LF12 | NOISe | LF1Noise | LF2Noise
*RST: LF1

Example:

LFO:SOUR NOIS
selects the noise generator as source for the LF output signal.

Options:

Option R&S SMA-K24 for selections other than LF1

[[:SOURce]:LFOutput[:STATe] <State>

The command activates/deactivates the LF output.

Parameters:

<State> 0 | 1 | OFF | ON
*RST: OFF

Example:

LFO ON
activates the LF output. The settings under LFO:FREQ and LFO:SWE become effective.

Manual control:

See "[State - LF Output](#)" on page 298

[[:SOURce]:LFOutput:SWEep[:FREQUENCY]:DWELI <Dwell>

The command sets the dwell time for each frequency step of the sweep.

Tip: It is recommended to switch off the "GUI Update" for optimum sweep performance especially with short dwell times ([SYSTEM:DISPlay:UPDate OFF](#)).

Parameters:

<Dwell> float
Range: 3 ms to 100 s
Increment: 0.1 ms
*RST: 10 ms
Default unit: ms

Example:

LFO:SWE:DWEL 20 ms
sets a dwell time of 20 ms.

Manual control:

See "[Dwell Time - LF Sweep](#)" on page 296

[[:SOURce]:LFOutput:SWEep[:FREQUENCY]:EXECute

The command immediately starts an LF sweep.

The command is only valid for sweep mode Single
(`SOURce:LFOutput:SWEep:FREQuency:MODE SINGLE`).

The command corresponds to the manual-control [Execute Single Sweep - LF Sweep](#).

Example: `LFO:SWE:MODE SING`
sets the single cycle mode of the LF sweep.
`LFO:SWE:EXEC`
starts one cycle of the LF sweep.

Usage: Event

Manual control: See "[Execute Single Sweep - LF Sweep](#)" on page 295

`[:SOURce]:LFOutput:SWEep[:FREQuency]:LFSource <LFSOURCE>`

The command selects the source for the LF sweep.

Parameters:
`<LFSOURCE>` LF1 | LF2
*RST: LF1

Example: `LFO:SWE:LFS LF2`
selects LF generator 2 as the LF frequency sweep source.

Options: Option R&S SMA-K24

Manual control: See "[Sweep Source - LF Sweep](#)" on page 295

`[:SOURce]:LFOutput:SWEep[:FREQuency]:MODE <MODE>`

The command sets the cycle mode of the LF sweep.

The assignment of the GPIB commands to the sweep modes is given in the description of the sweep menus.

Parameters:

<Mode>

AUTO | MANual | STEP

AUTO

Each trigger triggers exactly one complete sweep.

MANual

The trigger system is not active. Each frequency step of the sweep is triggered individually, either by varying the "Current Frequency" value using the rotary knob under manual control or by means of a :LFOuTput:FREQ:MAN command under remote control.

With manual control, the frequency increases or decreases (depending on the direction of the rotary encoder) by the value specified under SOUR:LFO:SWE:FREQ:STEP:LIN (linear spacing) or . . . :STEP:LOG (logarithmic spacing).

With remote control, the frequency increases by the value specified under LFO:SWE:FREQ:STEP:LIN|LOG which each sent [:SOURce]:LFOuTput:FREQuency:MANual command, irrespective the value entered there.

STEP

Each trigger triggers one sweep step only. The frequency increases by the value entered under

```
[SOURce:]LFOuTput:SWEep:STEP.
```

```
*RST:      AUTO
```

Example:

```
LFO:SWE:MODE AUTO
selects Mode Auto.
```

Manual control:

See "[Mode - LF Sweep](#)" on page 292

```
[:SOURce]:LFOuTput:SWEep[:FREQuency]:POINTs <Points>
```

The command sets the number of steps in an LF sweep.

The command is linked to the command :LFOuTput:SWEep[:FREQuency]:STEP as follows:

- for linear sweeps and START < STOP
 $POINTs = ((STOP - START) / STEP:LIN) + 1$
- for logarithmic sweeps and START < STOP
 $POINTs = ((\log STOP - \log START) / \log STEP:LOG) + 1$

If POINTs changes, the value of STEP is adjusted. The START and STOP value is retained.

Two separate POINTs values are used for linear or logarithmic sweep spacing (LFOuTput:SWEep[:FREQuency]:SPACing LIN | LOG). The command is always effective for the currently set sweep spacing.

Parameters:

<Points>

float

Increment: 1

*RST: 100

Example:

```
LFO:FREQ:STAR
sets the start frequency to 2 kHz.
LFO:FREQ:STOP
sets the stop frequency to 20 kHz
LFO:SWE:SPAC LIN
sets linear sweep spacing.
LFO:SWE:POIN 11
sets 11 sweep steps for linear sweep spacing. The sweep step
width (STEP) is automatically set to 2 kHz.
```

[[:SOURce]:LFOOutput:SWEep[:FREQUENCY]:SHAPE <Shape>

The command sets the cycle mode for a sweep sequence (shape).

Parameters:

<Shape> SAWTooth | TRiangle

SAWTooth

One sweep runs from start to stop frequency. Each subsequent sweep starts at the start frequency, i.e. the shape of the sweep sequence resembles a sawtooth.

TRiangle

One sweep runs from start to stop frequency and back, i.e. the shape of the sweep resembles a triangle. Each subsequent sweep starts at the start frequency.

*RST: SAWTooth

Example:

```
SOUR:LFO:SWE:SHAP TRI
selects the sweep cycle with alternating ascending and descend-
ing sweep directions.
```

Manual control: See "[Shape - LF Frequency Sweep](#)" on page 295

[[:SOURce]:LFOOutput:SWEep[:FREQUENCY]:SPACING <Spacing>

The command selects linear or logarithmic sweep spacing.

Parameters:

<Spacing> LINear | LOGarithmic

*RST: LINear

Example:

```
LFO:SWE:SPAC LIN
selects linear sweep spacing.
```

Manual control: See "[Spacing - LF Sweep](#)" on page 295

[[:SOURce]:LFOOutput:SWEep[:FREQUENCY]:STEP[:LINear] <Linear>

The command sets the step width for the linear sweep.

This command is linked to the command `:LFOOutput:SWEep[:FREQuency]:POINTs` as follow.

- for `START < STOP:`

$$POINTs = ((STOP-START) / STEP:LIN) + 1$$

If `STEP:LIN` changes, the value of `POINTs` is adjusted. The `START` and `STOP` value is retained.

Parameters:

<Linear> float
 Range: 0 to STOP-START
 Increment: 0.1 Hz

Example:

`LFO:FREQ:STAR`
 sets the start frequency to 2 kHz.
`LFO:FREQ:STOP`
 sets the stop frequency to 20 kHz.
`LFO:SWE:SPAC LIN`
 sets linear sweep spacing.
`LFO:SWE:STEP 2 kHz`
 sets the sweep step width to 2 kHz. The number of sweep steps for linear sweep spacing (`POINTs`) is automatically set to 11.

Manual control: See "[Step Lin/Log - LF Sweep](#)" on page 296

[:SOURce]:LFOOutput:SWEep[:FREQuency]:STEP:LOGarithmic <Logarithmic>

The command specifies the step width factor for logarithmic sweeps. The next frequency value of a sweep is calculated (for `START < STOP`) using the following formula:

New frequency = Old frequency + `STEP:LOG` x Old frequency

`STEP:LOG` therefore gives the fraction of the old frequency. The frequency is increased by this fraction for the next sweep step. Usually `STEP:LOG` is given in percent, whereby the suffix `PCT` must always be used.

The command is linked to the command `:LFOOutput:SWEep[:FREQuency]:POINTs` as follows:

- for logarithmic sweeps and `START < STOP:`

$$POINTs = ((\log STOP - \log START) / \log STEP:LOG) + 1$$

If `STEP:LOG` changes, the value of `POINTs` is adjusted. The `START` and `STOP` value is retained.

Parameters:

<Logarithmic> float
 Range: 0.01PCT to 100PCT
 Increment: 0.01PCT
 *RST: 1

- Example:** LFO:FREQ:STAR
sets the start frequency to 1 kHz.
LFO:FREQ:STOP
sets the stop frequency to 100 kHz.
LFO:SWE:SPAC LOG
sets logarithmic sweep spacing.
LFO:SWE:STEP:LOG 10PCT
sets the step width for logarithmic sweep spacing to 10% of the previous frequency in each instance.
- Manual control:** See "[Step Lin/Log - LF Sweep](#)" on page 296

[:SOURce]:LFOOutput<ch>:SHAPE <Shape>

Selects the shape of the LF generator.

Parameters:

<Shape> SINE | SQUare | TRIangle | TRAPeze

TRAPeze

In case of selection TRAPeze additional settings concerning the duration of the single trapeze elements can be made.

*RST: SINE

- Example:** LFO:SHAP SQU
selects a rectangular shape for the signal of the LF generator.

Options: Option R&S SMA-K24

Manual control: See "[LF Gen 2 Shape](#)" on page 217

[:SOURce]:LFOOutput<ch>:SHAPE:TRAPeze:FALL <Fall>

The command selects the fall time for the trapeze shape of the second LF generator.

The command selects the fall time for the trapeze shape of the LF generator.

Parameters:

<Fall> float
Range: 0 us to 10 s
Increment: 20 ns
*RST: 10 us

- Example:** SOUR:LFO2:SHAP:TRAP:FALL 100s
selects a fall time of 100 s for trapezoid shape of the signal of LF generator 2.

Options: Option R&S SMA-K24

Manual control: See "[Trapeze Fall - LF Output](#)" on page 300

[:SOURce]:LFOOutput<ch>:SHAPE:TRAPeze:HIG <High>

The command elects the high time for the trapeze shape of the second LF generator.

The command sets the high time for the trapeze shape of the LF generator.

Parameters:

<High> float
 Range: 0 us to 10 s
 Increment: 20 ns
 *RST: 10 us

Example:

SOUR:LFO2:SHAP:TRAP:HIGH 100s
 selects a high time of 100 s for trapeze shape of the signal of LF generator 2.

Options: Option R&S SMA-K24

Manual control: See "[Trapeze High - LF Output](#)" on page 300

[:SOURce]:LFOutput<ch>:SHAPE:TRAPe:LOW <Low>

The command selects the low time for the trapeze shape of the second LF generator.

Parameters:

<Low> float
 Range: 0 us to 10 s
 Increment: 20 ns
 *RST: 10 us

Options: Option R&S SMA-K24

Manual control: See "[Trapeze Low - LF Output](#)" on page 300

[:SOURce]:LFOutput<ch>:SHAPE:TRAPe:RISE <Rise>

The command selects the rise time for the trapeze shape of the second LF generator.

Parameters:

<Rise> float
 Range: 0 us to 10 s
 Increment: 20 ns
 *RST: 10 us

Example:

SOUR:LFO2:SHAP:TRAP:RISE 100s
 selects a rise time of 100 s for trapeze shape of the signal of LF generator 2.

Options: Option R&S SMA-K24

Manual control: See "[Trapeze Rise - LF Output](#)" on page 299

[:SOURce]:LFOutput:VOLTage <Voltage>

The command sets the output voltage of the LF output.

Parameters:

<Voltage> float
 Range: 0 to 4
 Increment: 0.001
 *RST: 1
 Default unit: V

Example:

LFO:VOLT 3 V
 sets the voltage of the LF output to 3 V.

Manual control:

See ["Output Voltage - LF Output"](#) on page 298

7.13.11 SOURce:LIST Subsystem

This subsystem contains the commands for the List mode of the instrument.

The following settings are required to operate the instrument in List mode:

1. Create a list.

If a list which does not exist is selected with the `:LIST:SEL` command, an empty list with the name of the selected list is created.

```
SOURce1:LIST:SEL "New_list"
```

2. Fill the list with values.

All list components must be of the same length. This does not apply to components of length 1. This is interpreted as if the component has the same length as the other components and as if all values are the same as the first value.

```
SOURce1:LIST:FREQ 100 MHz, 110 MHz, 120 MHz...
SOURce1:LIST:POW 2dBm, -1dBm, 0dBm...
```

3. Select a list.

If a new empty file has been created with the `:LIST:SEL` command, this file is selected, otherwise an existing list must be selected before the List mode is activated.

```
SOURce1:LIST:SEL "Old_list"
```

4. Set the dwell time.

The dwell time determines the duration of the individual list steps.

```
SOURce1:LIST:DWELL 3ms
```

5. Set the List mode.

The List mode determines the way in which the list is processed. In the example the list is processed once only or repeatedly depending on the trigger setting.

```
SOURce1:LIST:MODE AUTO
```

6. Determine the trigger.

In the example each trigger causes the list to be processed once from beginning to end.

```
SOURce:LIST:TRIGger:SOURce SINGLE
```

7. Activate the List mode.

```
SOURce1:FREQuency:MODE LIST
```

8. Trigger the list (depending on the mode).
SOURce1:LIST:TRIGger:EXECute
9. Deactivate the List mode.
SOURce1:FREQuency:MODE CW



SCPI refers to the individual lists as segments.

[:SOURce<hw>]:LIST:CATalog?.....	538
[:SOURce<hw>]:LIST:DELete.....	539
[:SOURce<hw>]:LIST:DELete:ALL.....	539
[:SOURce<hw>]:LIST:DEXChange:AFILe:CATalog?.....	540
[:SOURce<hw>]:LIST:DEXChange:AFILe:EXTension.....	540
[:SOURce<hw>]:LIST:DEXChange:AFILe:SELEct.....	541
[:SOURce<hw>]:LIST:DEXChange:AFILe:SEParator:COLumn.....	541
[:SOURce<hw>]:LIST:DEXChange:AFILe:SEParator:DECimal.....	542
[:SOURce<hw>]:LIST:DEXChange:EXECute.....	542
[:SOURce<hw>]:LIST:DEXChange:MODE.....	543
[:SOURce<hw>]:LIST:DEXChange:SELEct.....	543
[:SOURce<hw>]:LIST:DWELL.....	544
[:SOURce<hw>]:LIST:FREE?.....	544
[:SOURce<hw>]:LIST:FREQuency.....	544
[:SOURce<hw>]:LIST:FREQuency:POINts?.....	545
[:SOURce<hw>]:LIST:INDex.....	545
[:SOURce<hw>]:LIST:INDex:STARt.....	546
[:SOURce<hw>]:LIST:INDex:STOP.....	546
[:SOURce<hw>]:LIST:LEARn.....	547
[:SOURce<hw>]:LIST:MODE.....	547
[:SOURce<hw>]:LIST:POWEr.....	548
[:SOURce<hw>]:LIST:POWEr:AMODE.....	548
[:SOURce<hw>]:LIST:POWEr:POINts?.....	549
[:SOURce<hw>]:LIST:RESet.....	549
[:SOURce<hw>]:LIST:SELEct.....	549
[:SOURce<hw>]:LIST:TRIGger:EXECute.....	549
[:SOURce<hw>]:LIST:TRIGger:SOURce.....	550

[:SOURce<hw>]:LIST:CATalog?

The command requests a list of available lists. The individual lists are separated by commas.

The lists are stored with the fixed file extensions *.lsw in a directory of the user's choice. The directory applicable to the commands is defined with the command

MMEMoRY:CDIR.

Return values:

<Catalog> string

Example: `MMEM:CDIR '/var//Lists/Listmode'`
 selects the directory for the list mode files.
`LIST:CAT?`
 queries the available lists.
 Response: 'list1,list2'
 the lists list1 and list2 are available.

Usage: Query only

[:SOURce<hw>]:LIST:DELeTe <Delete>

The command deletes the specified list.

The files are stored with the fixed file extensions *.lsw in a directory of the user's choice. The directory applicable to the command is defined with the command `MMEMoRY:CDIR`. To access the files in this directory, only the file name has to be given, without the path and the file extension. A path can also be specified in command `:SOUR:LIST:CAT?`, in which case the file in the specified directory is deleted.

*RST does not affect data lists.

Setting parameters:

<Delete> <list file name>

Example: `MMEM:CDIR '/var//Lists/Listmode'`
 selects the directory for the list mode files.
`LIST:DEL 'LIST1'`
 deletes the list list1.

Usage: Setting only

Manual control: See "[List Mode Data... - List Mode](#)" on page 208

[:SOURce<hw>]:LIST:DELeTe:ALL

The command deletes all lists in the set directory. The List mode must be deactivated beforehand to ensure that no lists are selected when this command is called (`SOUR:FREQ:MODE CW` or `SWE`).

The files are stored with the fixed file extensions *.lsw in a directory of the user's choice. The directory applicable to the command is defined with the command `MMEMoRY:CDIR`. A path can also be specified in command `SOUR:LIST:CAT?`, in which case all list mode files in the specified directory are deleted.

*RST does not affect data lists.

- Example:** `MMEM:CDIR '/var//Lists/Listmode'`
selects the directory for the list mode files.
- `FREQ:MODE SWE`
deactivates the List mode for RF output and activates the Sweep mode.
- `SOUR2:FREQ:MODE SWE`
deactivates the List mode for RF output and activates Sweep mode.
- `LIST:DEL:ALL`
deletes all list mode files available in the set directory.
- Usage:** Event
- Manual control:** See "[List Mode Data... - List Mode](#)" on page 208

[:SOURce<hw>]:LIST:DEXChange:AFILe:CATalog?

The command requests a list of available ASCII files for export/import of list mode data. The individual files are separated by commas.

The ASCII files are stored with the fixed file extensions `*.txt` or `*.csv` in a directory of the user's choice. The directory applicable to the commands is defined with the command `MMEMoRY:CDIR`.

Return values:

<Catalog> string

- Example:** `MMEM:CDIR '/var//lists/listmode/import'`
selects the directory for the ASCII files with frequency and level value pairs.
- `LIST:DEXC:AFIL:EXT TXT`
selects that ASCII files with extension `*.txt` are listed.
- `LIST:DEXC:AFIL:CAT?`
queries the available files with extension `*.txt`.
- Response: 'list1,list2'
the ASCII files `list1.txt` and `list2.txt` are available.

Usage: Query only

[:SOURce<hw>]:LIST:DEXChange:AFILe:EXTension <Extension>

The command selects the file extension of the ASCII file to be imported or exported. Selection `TXT` (text file) or `CSV` (Excel file) is available.

Parameters:

<Extension> `TXT | CSV`

*RST: `TXT`

Example: `MMEM:CDIR '/var//lists/listmode/import'`
 selects the directory for the ASCII files with frequency and level value pairs.
`LIST:DEXC:AFIL:EXT TXT`
 selects that ASCII files with extension `*.txt` are listed.
`LIST:DEXC:AFIL:CAT?`
 queries the available files with extension `*.txt`.
 Response: `'list1,list2'`
 the ASCII files `list1.txt` and `list2.txt` are available.

Manual control: See ["Extension - List Mode"](#) on page 210

[[:SOURce<hw>]:LIST:DEXChange:AFIL:SElect <Select>

The command selects the ASCII file to be imported or exported.

The ASCII files are stored with the fixed file extensions `*.txt` or `*.csv` in a directory of the user's choice. The directory applicable to the commands is defined with the command `MMEMoRY:CDIR`. A path can also be specified in command `SOUR:LIST:DEXC:AFIL:SEL`, in which case the files are stored or loaded in the specified directory.

Parameters:

<Select> <ascii_file_name>

Example:

`LIST:DEXC:MODE IMP`
 selects that ASCII files with frequency and level value pairs are imported and transferred into list mode lists.
`LIST:DEXC:AFIL:SEL`
`'/var//user/listmode/import/list.csv'`
 selects that ASCII file `list.csv` is imported.
`LIST:DEXC:SEL`
`'/var//user/listmode/import/list_imp'`
 selects that the ASCII file `list.csv` is imported into list mode list `list_imp`.

Manual control: See ["Select ASCII Source / Destination - List Mode"](#) on page 211

[[:SOURce<hw>]:LIST:DEXChange:AFIL:SEPARATOR:COLumn <Column>

The command selects the separator between the frequency and level column of the ASCII table.

Parameters:

<Column> TABulator | SEMicolon | COMMa | SPACe
 *RST: COMMa

Example:

```
LIST:DEXC:MODE EXP
selects that the list mode list is exported into an ASCII file.
LIST:DEXC:AFIL:SEL
'/var//user/listmode/import/list.csv'
selects ASCII file list.csv as destination for the list mode list
data.
LIST:DEXC:AFIL:SEP:COL TAB
the pairs of frequency and level values are separated by a tabu-
lator.
LIST:DEXC:AFIL:SEP:DEC DOT
selects the decimal separator dot.
LIST:DEXC:SEL
'/var//user/listmode/import/list_imp'
selects that the list mode list list_imp is imported into ASCII file
list.csv.
```

Manual control: See ["Column Separator- List Mode"](#) on page 211

[:SOURce<hw>]:LIST:DEXChange:AFILe:SEParator:DECimal <Decimal>

The command the decimal separator used in the ASCII data between '.' (decimal point) and ',' (comma) with floating-point numerals.

Parameters:

<Decimal> DOT | COMMa
*RST: DOT

Example:

```
LIST:DEXC:MODE EXP
selects that the list mode list is exported into an ASCII file.
LIST:DEXC:AFIL:SEL
'/var//user/listmode/import/list.csv'
selects ASCII file list.csv as destination for the list mode list
data.
LIST:DEXC:AFIL:SEP:COL TAB
the pairs of frequency and level values are separated by a tabu-
lator.
LIST:DEXC:AFIL:SEP:DEC DOT
selects the decimal separator dot.
LIST:DEXC:SEL
'root/var//user/listmode/import/list_imp'
selects that the list mode list list_imp is imported into ASCII file
list.csv.
```

Manual control: See ["Decimal Point - List Mode"](#) on page 211

[:SOURce<hw>]:LIST:DEXChange:EXECute

The command starts the export or import of the selected file. When import is selected, the ASCII file is imported as list mode list. When export is selected, the list mode list is exported into the selected ASCII file.

Example: LIST:DEXC:MODE IMP
 selects that ASCII files with frequency and level value pairs are imported and transferred into list mode lists.
 LIST:DEXC:AFIL:SEL
 '/var//user/listmode/import/list.csv'
 selects that ASCII file list.csv is imported.
 LIST:DEXC:SEL
 '/var//user/listmode/import/list_imp'
 selects that the ASCII file list.csv is imported into list mode list list_imp.
 LIST:DEXC:EXEC
 starts the import of the ASCII file data into the list mode file.

Usage: Event

Manual control: See "[Import / Export - List Mode](#)" on page 211

[[:SOURce<hw>]:LIST:DEXChange:MODE <Mode>

The command selects if list mode lists should be imported or exported. Depending on the selection here, the file select command defines either the source or the destination for list mode lists and ASCII files.

Parameters:

<Mode> IMPort | EXPort
 *RST: IMPort

Example: LIST:DEXC:MODE IMP
 selects that ASCII files with frequency and level value pairs are imported and transferred into list mode lists.
 LIST:DEXC:AFIL:SEL
 '/var//user/listmode/import/list.csv'
 selects that ASCII file list.csv is imported.
 LIST:DEXC:SEL
 'root/var//user/listmode/import/list_imp'
 selects that the ASCII file list.csv is imported into list mode list list_imp.

Manual control: See "[Mode - List Mode](#)" on page 210

[[:SOURce<hw>]:LIST:DEXChange:SElect <Select>

The command selects the list mode list to be imported or exported.

The list mode files are stored with the fixed file extensions *.lsw in a directory of the user's choice. The directory applicable to the commands is defined with the command `MMEMory:CDIR`. A path can also be specified in command `SOUR:LIST:DEXC:SEL`, in which case the files are stored or loaded in the specified directory.

Parameters:

<Select> <list_name>

- Example:** LIST:DEXC:MODE IMP
selects that ASCII files with frequency and level value pairs are imported and transferred into list mode lists.
LIST:DEXC:AFIL:SEL
`/var//user/listmode/import/list.csv'
selects that ASCII file list.csv is imported.
LIST:DEXC:SEL
`/var//user/listmode/import/list_imp'
selects that the ASCII file list.csv is imported into list mode list list_imp.
- Manual control:** See "[Select Destination / Source - List Mode](#)" on page 211

[:SOURce<hw>]:LIST:DWELI <Dwell>

The command sets the time for which the instrument retains a setting.

Parameters:

<Dwell> float
Range: 0.5 ms to 100 s
Increment: 1E-4
*RST: 10.0 ms
Default unit: s

- Example:** LIST:DWEL 15
each setting in the list is retained for 15 ms.

- Manual control:** See "[Dwell Time - List Mode](#)" on page 207

[:SOURce<hw>]:LIST:FREE?

This command queries on the free storage space for list mode lists.

Return values:

<Free> integer
Range: 0 to INT_MAX
Increment: 1
*RST: 0

- Example:** LIST:FREE?

- Usage:** Query only

Response: 2147483647;1

[:SOURce<hw>]:LIST:FREQUency <Frequency>

The command fills the FREQUency part of the selected list with data.

*RST does not affect data lists.

Parameters:

<Frequency>

<Frequency#1>{, <Frequency#2>, ...} | block data

The data can be given either as a list of numbers (list can be of any length and list entries must be separated by commas) or as binary block data. When block data is transferred, 8 (4) bytes are always interpreted as a floating-point number with double accuracy (see :FORMat [:DATA] on page 371).

Range: 300 kHz to RFmax (RFmax depending on model)

Example:

```
LIST:SEL '/var//Lists/Listmode/list3'
```

selects list3 for editing. List3 is created if it does not yet exist.

```
SOUR:LIST:FREQ 1.4GHz, 1.3GHz, 1.2GHz,...
```

specifies the frequency values in list3. If the list already contains data, it is overwritten.

Usage:

SCPI confirmed

Manual control:

See "Edit List Mode Data... - List Mode" on page 208

[[:SOURce<hw>]:LIST:FREQUENCY:POINTS?

The command queries the length (in points) of the FREQUENCY component of the selected list.

Return values:

<Points>

float

Example:

```
LIST:SEL '/var//Lists/Listmode/list3'
```

selects list3 for editing. List3 is created if it does not yet exist.

```
LIST:FREQ:POIN?
```

queries the number of frequency values in list3.

```
Response: 327
```

list3 has 327 frequency entries.

Usage:

Query only

[[:SOURce<hw>]:LIST:INDEX <Index>

The command sets the list index in step mode (LIST:MODE STEP).

After the trigger signal the frequency and level settings of the selected index are processed in List mode.

Parameters:

<Index>

float

*RST: 0

Example:

```
LIST:SEL '/var//Lists/Listmode/list3'
```

selects list3 for use in List mode.

```
FREQ:MODE LIST
```

activates List mode. List3 is processed.

```
LIST:MODE STEP
```

selects manual, step-by-step processing of the list.

```
LIST:IND 5
```

the frequency/level value pair with index 5 is executed.

```
TRIG:LIST:SOUR SING
```

selects triggering by means of the single trigger. The list is executed once.

```
SOUR:LIST:TRIG:EXEC
```

triggers the processing of the selected list.

Manual control: See "[Current Index - List Mode](#)" on page 207

[[:SOURce<hw>]:LIST:INDEX:START <Start>

The command sets the start index of the index range which defines a subgroup of frequency/level value pairs in the current list. Only the values in the set index range (:LIST:INDEX:START ... :LIST:INDEX:STOP) are processed in List mode.

Parameters:

<Start> float
 Range: 0 to list length
 *RST: 0

Example:

```
LIST:SEL '/var//Lists/Listmode/list3'
```

selects list3 for use in List mode.

```
LIST:IND:STAR 25
```

sets 25 as start index of the index range.

```
LIST:IND:STOP 49
```

sets 49 as stop index of the index range.

```
FREQ:MODE LIST
```

activates List mode. The frequency/level value pairs from index 25 to index 49 in list3 are processed. All other entries of the list are ignored.

Manual control: See "[List Range In - List Mode](#)" on page 209

[[:SOURce<hw>]:LIST:INDEX:STOP <Stop>

The command sets the stop index of the index range which defines a subgroup of frequency/level value pairs in the current list. Only the values in the set index range (:LIST:INDEX:START ... :LIST:INDEX:STOP) are processed in List mode.

Parameters:

<Stop> float
 Range: 0 to list length
 *RST: 0

Example: `LIST:SEL '/var//Lists/Listmode/list3'`
selects list3 for use in List mode.
`LIST:IND:STAR 25`
sets 25 as start index of the index range.
`LIST:IND:STOP 49`
sets 49 as stop index of the index range.
`FREQ:MODE LIST`
activates List mode. The frequency/level value pairs from index 25 to index 49 in list3 are processed. All other entries of the list are ignored.

Manual control: See "[List Range In - List Mode](#)" on page 209

[:SOURce<hw>]:LIST:LEARn

The command learns the selected list, i.e. it determines the hardware setting for the entire list. The data determined in this way is stored together with the list. When the list is activated for the first time, these settings are calculated automatically.

Example: `LIST:SEL '/var//Lists/Listmode/list3'`
selects list3. List3 is created if it does not yet exist.
`LIST:LEAR`
starts learning of the hardware setting for list3 and stores the setting.

Usage: Event

Manual control: See "[Learn List Mode Data... - List Mode](#)" on page 207

[:SOURce<hw>]:LIST:MODE <Mode>

The command specifies how the list is to be processed (similar to `SOURce:SWEep:MODE`).

Parameters:

<Mode>

AUTO | STEP

AUTO

Each trigger event triggers a complete list cycle. Possible trigger settings for `:LIST:TRIGger:SOURce` are AUTO, SINGLE and EXT.

STEP

Each trigger event triggers only one step in the list processing cycle. The list is processed in ascending order.

The external trigger has to be used (setting `:LIST:TRIGger:SOURce EXT`).

*RST: AUTO

Example: `LIST:MODE STEP`
selects step-by-step processing of the list.

Usage: SCPI confirmed

Manual control: See ["Mode - List Mode"](#) on page 205

[:SOURce<hw>]:LIST:POWER <Power>

The command fills the Level part of the selected list with data.

*RST does not affect data lists.

Parameters:

<Power> <Power#1>{, <Power#2>, ...} | block data
 The data can be given either as a list of numbers (list can be of any length and list entries must be separated by commas) or as binary block data. When block data is transferred, 8 (4) bytes are always interpreted as a floating-point number with double accuracy (see [:FORMat \[:DATA\]](#) on page 371).
 Range: Minimum level to Maximum level
 Default unit: dBm

Example: `LIST:SEL '/var//Lists/Listmode/list3'`
 selects list3 for editing. List3 is created if it does not yet exist.
`LIST:POW 0dBm, 2dBm, 2dBm, 3dBm, ..`
 specifies the level values in list3. The number of level values must correspond to the number of frequency values. The previous data is overwritten.

Usage: SCPI confirmed

Manual control: See ["Edit List Mode Data... - List Mode"](#) on page 208

[:SOURce<hw>]:LIST:POWER:AMODE <Amode>

The command selects the ranges of level settings for the list mode. The level settings are either performed in the low level or in the high level ranges.

Parameters:

<Amode> NORMal | HPOWer
NORMal
 The level settings are made in the range of the electronically switching attenuator. The high level ranges are not available.
HPOWer
 The level settings are made in the range of the option. Only the high level range is available.
 *RST: NORMal

Example: `LIST:POW:AMOD HPOW`
 selects the high level ranges for List Mode.

Manual control: See ["Attenuator Mode – List Mode with High Power Option"](#) on page 205

[[:SOURce<hw>]:LIST:POWER:POINTS?

The command queries the length (in points) of the LEVEL part of the selected list.

Return values:

<points> float

Example: LIST:SEL '/var//Lists/Listmode/list3'
selects list3 for editing. List3 is created if it does not yet exist.
LIST:POW:POIN?
queries the number of levels in list3.
Response: 327
LIST2 has 327 level entries.

Usage: Query only
SCPI confirmed

[[:SOURce<hw>]:LIST:RESet

The command resets the list to the starting point.

Example: LIST:RES
resets the list to the starting point.

Usage: Event

Manual control: See "[Reset - List Mode](#)" on page 207

[[:SOURce<hw>]:LIST:SElect <Select>

The command selects the specified list. If a new list is to be created, the name can be entered here. The list is created if it does not yet exist. The list selected here is available for the further processing steps (editing) and is used in the instrument when the List mode is activated.

The files are stored with the fixed file extensions *.lsw in a directory of the user's choice. The directory applicable to the command is defined with the command MEMORY:CDIR. A path can also be specified in command :SOUR:LIST:SEL in which case the list mode file in the specified directory is selected.

*RST does not affect data lists.

Parameters:

<Select> '<list name>'

Example: LIST:SEL '/var//Lists/Listmode/list3'
selects list3 for editing. List3 is created if it does not yet exist.

Manual control: See "[List Mode Data... - List Mode](#)" on page 208

[[:SOURce<hw>]:LIST:TRIGger:EXECute

The command immediately starts the processing of a list in list mode. It corresponds to the manual-control command "Execute Single."

- Example:** SOUR:LIST:TRIG:EXEC
triggers the processing of the selected list.
- Usage:** Event
- Manual control:** See "[Execute Single - List Mode](#)" on page 207

[:SOURce<hw>]:LIST:TRIGger:SOURce <Source>

The command sets the trigger source for the LIST mode.

The names of the parameters correspond to those under sweep mode. SCPI uses other names for the parameters; these names are also accepted by the instrument. The SCPI names should be used if compatibility is an important consideration. An overview of the various names is given in the following table:

R&S name	SCPI name	Command under manual control
AUTO	IMMediate	MODE AUTO
SINGle	BUS	MODE SINGLE or STEP
EXTernal	EXTernal	MODE EXT TRIG SINGLE or EXT TRIG STEP

Parameters:

<Source>

AUTO | IMMediate | SINGle | BUS | EXTernal | HOP | DHOP

AUTO|IMMediate

The trigger is free-running, i.e. the trigger condition is fulfilled continuously. The selected list in List mode is restarted as soon as it is finished.

SINGle|BUS

The list is triggered by the GPIB commands `[:SOURce<hw>] :LIST:TRIGger:EXECute`. The list is executed once.

EXTernal

The list is triggered externally via the INST TRIG connector. The list is executed once.

HOP

Index-by-index cycle. The processed list index is determined by the external control signals provided via the serial FHOP bus. Processing of the frequency and level settings associated with selected index is triggered externally via the INST TRIG connector.

DHOP

Index-by-index cycle. The processed list index is determined by the external control signals provided via the serial FHOP bus. Processing of the frequency and level settings associated with selected index is automatically started at the end of data transmission.

*RST: SINGle

Example: `LIST:TRIG:SOUR EXT`
selects triggering by means of the external trigger.

Manual control: See "Mode - List Mode" on page 205

7.13.12 SOURce:MBEacon Subsystem

The MBEacon subsystem contains the commands for checking the Marker Beacon modulation. The AM-specific characteristics of the internal modulation source are defined with commands `SOURce:MBEacon:...` Characteristics which are valid for all modulations and the LF Output are configured in the `SOURce:LFOutput` subsystem. The signal is output at the LF OUT connector.

<code>[:SOURce]:MBEacon:COMid:CODE</code>	551
<code>[:SOURce]:MBEacon:COMid:DASH</code>	552
<code>[:SOURce]:MBEacon:COMid:DEPTH</code>	552
<code>[:SOURce]:MBEacon:COMid:DOT</code>	553
<code>[:SOURce]:MBEacon:COMid:FREQuency</code>	553
<code>[:SOURce]:MBEacon:COMid:LETTer</code>	553
<code>[:SOURce]:MBEacon:COMid:PERiod</code>	554
<code>[:SOURce]:MBEacon:COMid:SYMBol</code>	554
<code>[:SOURce]:MBEacon:COMid:TSCHema</code>	555
<code>[:SOURce]:MBEacon:COMid[:STATe]</code>	555
<code>[:SOURce]:MBEacon:PRESet</code>	556
<code>[:SOURce]:MBEacon:STATe</code>	556
<code>[:SOURce]:MBEacon[:MARKer]:DEPTH</code>	556
<code>[:SOURce]:MBEacon[:MARKer]:FREQuency</code>	557
<code>[:SOURce]:MBEacon[:MARKer]:PULSed</code>	557

`[:SOURce]:MBEacon:COMid:CODE <Code>`

Enters the coding of the COM/ID signal by the international short name of the airport (e.g. MUC for the Munich airport). (COM/ID signal).

The COM/ID tone is sent according to the selected code (see [table 5-13](#)). If no coding is entered, the COM/ID tone is sent uncoded (key down).

The length of the morse code can be varied. For selection standard time scheme (`MBE:COM:TSCH STD`), the selected dot length determines the setting of all other length parameters of the morse code (dash length, symbol space and letter space) . For selection user time scheme (`MBE:COM:TSCH USER`), all length parameters of the code can be set independently.

Parameters:

<Code> string

Example: `MBE:COM:CODE 'MUC'`
select COM/ID code for Munich airport.

Usage: SCPI confirmed

Options: Option R&S SMA-K25

Manual control: See ["COM/ID Code - Marker Beacon Modulation"](#) on page 284

[:SOURce]:MBEacon:COMid:DASH <Dash>

Enters the length of a morse dash by means of seconds. This command is available for user time schema only.

Parameters:

<Dash> float
 Range: 50 ms to 1 s
 Increment: 0.1 ms
 *RST: 300 ms
 Default unit: ms

Example:

```
MBE:COM:CODE 'MUC'
selects code for Munich airport
MBE:COM:TSCH USER
selects user time schema
MBE:COM:DOT 200ms
sets a dot length of 200 ms.
MBE:COM:DASH 400ms
sets a dash length of 400 ms.
MBE:COM:LETT 50ms
sets a letter space of 50 ms.
MBE:COM:SYMB 10ms
sets a symbol space of 10 ms.
```

Options: Option R&S SMA-K25

Manual control: See ["COM/ID Dash Length - Marker Beacon Modulation"](#) on page 286

[:SOURce]:MBEacon:COMid:DEPTH <Depth>

The command enters the AM modulation depth of the additional communication/identification signal.

Parameters:

<Depth> float
 Range: 0 PCT to 100 PCT
 Increment: 0.1 PCT
 *RST: 5 PCT
 Default unit: PCT

Example:

```
MBE:COM:FREQ 1020
sets the frequency of the communication/identification signal to
the standard value of 1020Hz
```

Options: Option R&S SMA-K25

Manual control: See ["COM/ID Depth - Marker Beacon Modulation"](#) on page 285

[:SOURce]:MBEacon:COMid:DOT <Dot>

Enters the length of a morse dot by means of seconds. The length of the dash (3xdot), symbol space (=dot) and letter space (=3xdot) is also determined by this entry.

Parameters:

<Dot> float
 Range: 50 ms to 1 s
 Increment: 0.1 ms
 *RST: 100 ms
 Default unit: ms

Example:

MBE:COM:CODE 'MUC'
 selects code for Munich airport
 MBE:COM:DOT 200ms
 sets a dot length of 200 ms.

Options: Option R&S SMA-K25

Manual control: See "[COM/ID Dot Length - Marker Beacon Modulation](#)" on page 286

[:SOURce]:MBEacon:COMid:FREQuency <Frequency>

The command sets the frequency of the communication/identification signal.

Parameters:

<Frequency> float
 Range: 0.1 Hz to 20 kHz
 Increment: 0.1 Hz
 *RST: 1.020 kHz
 Default unit: Hz

Example:

MBE:COM:FREQ 1020
 sets the frequency of the communication/identification signal to the standard value of 1020Hz.

Options: Option R&S SMA-K25

Manual control: See "[COM/ID Frequency - Marker Beacon Modulation](#)" on page 285

[:SOURce]:MBEacon:COMid:LETTer <Letter>

Enters the length of a letter space by means of seconds. This command is available user time schema only.

Parameters:

<Letter> float
 Range: 50 ms to 1 s
 Increment: 0.1 ms
 *RST: 300 ms
 Default unit: ms

Example:

```

MBE:COM:CODE 'MUC'
selects code for Munich airport
MBE:COM:TSCH USER
selects user time schema
MBE:COM:DOT 200ms
sets a dot length of 200 ms.
MBE:COM:DASH 400ms
sets a dash length of 400 ms.
MBE:COM:LETT 50ms
sets a letter space of 50 ms.
MBE:COM:SYMB 10ms
sets a symbol space of 10 ms.

```

Options: Option R&S SMA-K25

Manual control: See ["COM/ID Letter Space - Marker Beacon Modulation"](#) on page 286

[[:SOURce]:MBEacon:COMid:PERiod <Period>

Enters the period of the COM/ID signal in seconds.

Parameters:

```

<Period>          float
                   Range:    0 ms to 120 s
                   Increment: 1 ms
                   *RST:     9 s

```

Example:

```

MBEA:COM:PER 17s
sets a period of 17 s for the COM/ID signal.

```

Options: Option R&S SMA-K25

Manual control: See ["COM/ID Period - Marker Beacon Modulation"](#) on page 285

[[:SOURce]:MBEacon:COMid:SYMBol <Symbol>

Enters the length of the symbol space by means of seconds. This command is available for user time schema only.

Parameters:

```

<Symbol>          float
                   Range:    50 ms to 1 s
                   Increment: 0.1 ms
                   *RST:     100 ms
                   Default unit: ms

```

Example:

```

MBE:COM:CODE 'MUC'
selects code for Munich airport
MBE:COM:TSCH USER
selects user time schema
MBE:COM:DOT 200ms
sets a dot length of 200 ms.
MBE:COM:DASH 400ms
sets a dash length of 400 ms.
MBE:COM:LETT 50ms
sets a letter space of 50 ms.
MBE:COM:SYMB 10ms
sets a symbol space of 10 ms.

```

Options: Option R&S SMA-K25

Manual control: See ["COM/ID Symbol Space - Marker Beacon Modulation"](#) on page 286

[[:SOURce]:MBEacon:COMid:TSCHema <Tschema>

Selects if the set dot length determines the dash length (= three times the dot length) (setting STD) or if all length parameters can be set independently (setting USER). (COM/ID signal).

Parameters:

```

<Tschema>      STD | USER
*RST:          USER

```

Example:

```

MBE:COM:CODE 'MUC'
selects code for Munich airport
MBE:COM:TSCH STD
selects standard time schema
MBE:COM:DOT 200ms
sets a dot length of 200 ms. The dash length and letter space is 3
x dot length, the symbol space equals the dot length.

```

Options: Option R&S SMA-K25

Manual control: See ["COM/ID Time Schema - Marker Beacon Modulation"](#) on page 286

[[:SOURce]:MBEacon:COMid[:STATe] <State>

The command switches on or off the additional communication/identification signal.

Parameters:

```

<State>        0 | 1 | OFF | ON
*RST:          OFF

```

Example:

```

MBE:COM ON
activates the COM/ID signal.

```

Options: Option R&S SMA-K25

Manual control: See ["COM/ID State - Marker Beacon Modulation"](#) on page 284

[[:SOURce]:MBEacon:PRESet

The commands activate the Marker Beacon default setting. The command also sets the RF frequency to 75 MHz.

Example: `ILS:MBE:PRES`
activates the default settings for all SOURCe:MBE:... commands. It sets the RF frequency to 75 MHz.

Usage: Event
SCPI confirmed

Options: Option R&S SMA-K25

Manual control: See ["Set To Default - Marker Beacon Modulation"](#) on page 287

[[:SOURce]:MBEacon:STATe <State>

The commands activate/deactivate Marker Beacon modulation.

Parameters:
<State> 0 | 1 | OFF | ON
*RST: OFF

Example: `MBE:STAT ON`
activates Marker Beacon modulation.

Options: Option R&S SMA-K25

Manual control: See ["State - Marker Beacon Modulation"](#) on page 283

[[:SOURce]:MBEacon[:MARKer]:DEPTH <Depth>

Enters the modulation depth of the marker signal.

Parameters:
<Depth> float
Range: 0 to 100 PCT
Increment: 0.1 PCT
*RST: 95 PCT
Default unit: PCT

Example: `MBE:DEPT 30PCT`
enters a modulation depth of 30 percent for the marker.

Options: Option R&S SMA-K25

Manual control: See ["Marker Depth - Marker Beacon Modulation"](#) on page 283

[[:SOURce]:MBEacon[:MARKer]:FREQuency <Frequency>

Enters the modulation frequency of the marker signal.

Parameters:

<Frequency> 400Hz | 1300Hz | 3000Hz
 Range: 400 to 3000
 Increment: 0.1 Hz
 *RST: 400 Hz

Example:

MBE:FREQ 400
 'enters a frequency of 400 Hz for the marker.

Options:

Option R&S SMA-K25

Manual control:

See "[Marker Frequency - Marker Beacon Modulation](#)" on page 283

[[:SOURce]:MBEacon[:MARKer]:PULSed <Pulsed>

The commands activate the pulsed marker.

Parameters:

<Pulsed> 0 | 1 | OFF | ON
OFF
 The markers are output uncoded (key down).
ON
 The markers are output with the following on/off ratio:
 Outer Marker (400 Hz): 375 ms on, 125 ms off...
 Middle Marker (1300 Hz) 375 ms on, 125 ms off, 83 ms on, 83 ms off...
 Inner Marker (3000 Hz) 83 ms on, 83 ms off (6dots/sec)
 *RST: OFF

Example:

MBE:PULS
 activates the pulsed marker

Options:

Option R&S SMA-K25

Manual control:

See "[Pulsed Marker - Marker Beacon Modulation](#)" on page 283

7.13.13 SOURce:MODulation Subsystem

This subsystem contains the command for switching on/off all modulations.

[[:SOURce<hw>]:MODulation[:ALL]:STATe <State>

The command switches the modulations on and off.

The command `SOUR:MOD:ALL:STAT OFF` switches all modulations off. A subsequent command `SOUR:MOD:ALL:STAT ON` restores the status that was active before the last switch-off. "MOD OFF" is displayed in the info line of the header next to the "Level" field.

Parameters:

<State> 0 | 1 | OFF | ON

Example:

```
MOD:STAT OFF
switches off all modulations.
```

Manual control:

See "MOD ON/OFF" on page 213

7.13.14 SOURce:NOISe Subsystem

The SOURce:NOISe subsystem contains the commands for setting the noise modulation signal. The noise generator is optional.

[:SOURce<hw>]:NOISe:BWIDth.....	558
[:SOURce<hw>]:NOISe:BWIDth:STATe.....	558
[:SOURce<hw>]:NOISe:DISTRibution.....	559
[:SOURce<hw>]:NOISe:LEVel:RELative?.....	559
[:SOURce<hw>]:NOISe:LEVel[:ABSolute]?.....	559

[:SOURce<hw>]:NOISe:BWIDth <Bwidth>

This command sets the noise level in the system bandwidth for enabled bandwidth limitation. Distinct bandwidth settings between 10 kHz and 10 MHz in 100 kHz steps (range 100 .. 1 MHz), 1 MHz (range 1 MHz .. 5 MHz) and 5 MHz (5 MHz ... 10 MHz) are possible.

Parameters:

```
<Bwidth> float
Range: 100 kHz to 10 MHz
Increment: 100 kHz
*RST: 100 kHz
```

Example:

```
NOIS:BWID:STAT ON
enables bandwidth limitation.
NOIS:BWID 1 MHz
sets a system bandwidth of 1 MHz.
```

Options:

R&S SMA-K24

Manual control:

See "Bandwidth " on page 301

[:SOURce<hw>]:NOISe:BWIDth:STATe <State>

Enables /disables bandwidth limitation of noise.

Parameters:

```
<State> 0 | 1 | OFF | ON
*RST: OFF
```

Example:

```
NOIS:BWID:STAT ON
enables bandwidth limitation.
```

Options:

R&S SMA-K24

Manual control: See ["Bandwidth Limitation"](#) on page 300

[[:SOURce<hw>]:NOISe:DISTRibution <Distribution>

Selects the noise power density distribution of the noise.

Parameters:

<Distribution> GAUSs | EQUal
*RST: GAUSs

Example: NOIS:DIST GAUS ON
selects Gaussian distribution.

Options: R&S SMA-K24

Manual control: See ["Distribution - Noise"](#) on page 300

[[:SOURce<hw>]:NOISe:LEVel:RELative?

This command queries the level of the noise signal per Hz in the total bandwidth.

Return values:

<Relative> float

Example: NOIS:LEV:REL?
queries the noise level

Usage: Query only

Options: R&S SMA-K24

Manual control: See ["Noise Level - Noise"](#) on page 301

[[:SOURce<hw>]:NOISe:LEVel[:ABSolute]?

This command queries the level of the noise signal in the system bandwidth for enabled bandwidth limitation.

Return values:

<Absolute> float

Example: NOIS:BWID:STAT ON
enables bandwidth limitation.
NOIS:BWID 10 MHz
sets a system bandwidth of 1 MHz.
NOIS:LEV:ABS
queries the noise level in the system bandwidth

Usage: Query only

Options: R&S SMA-K24

Manual control: See ["Noise Level \(System Bandwidth\)"](#) on page 301

7.13.15 SOURce:PGEN Subsystem

This subsystem contains the commands for setting the pulse generator.

[\[:SOURce<hw>\]:PGEN:STATe](#).....560

[:SOURce<hw>]:PGEN:STATe <State>

The command activates/deactivates the output of the video/sync signal at the PULSE VIDEO connector at the rear of the instrument.

The signal output and the pulse generator are automatically switched on with activation of pulse modulation if pulse generator is selected as modulation source. The signal output can be switched off subsequently.

Parameters:

<State> 0 | 1 | OFF | ON
 *RST: OFF

Example:

```
PULM:SOUR INT
selects the internal pulse generator as source for pulse modulation
PULM:STAT ON
activates pulse modulation. The pulse generator and the output of
the signals at the PULSE VIDEO connector are automatically acti-
vated in addition.
PGEN:STAT OFF
deactivates the output of the pulse signal by the pulse generator
at the PULSE VIDEO connector. The pulse modulation of the RF
carrier must be activated with command SOURce:PULM:STATe.
```

Usage: SCPI confirmed

Manual control: See "[Video Sync Signal State - Pulse Generator](#)" on page 302

7.13.16 SOURce:PHASe Subsystem

This subsystem contains the commands for adjusting the phase of the RF output signal relative to a reference signal of the same frequency.

[\[:SOURce<hw>\]:PHASe](#).....560

[\[:SOURce<hw>\]:PHASe:REFerence](#).....561

[:SOURce<hw>]:PHASe <Phase>

The command specifies the phase variation relative to the current phase. The variation can be specified in RADians.

Parameters:

<Phase> float
 Range: -720 DEG to 720 DEG
 Increment: 0.01 DEG
 *RST: 0.0 DEG

- Example:** PHAS 2DEG
changes the phase by 2 degrees relative to the current phase.
PHAS:REF
adopts the set phase as the current phase.
- Manual control:** See ["Delta Phase - RF Signal"](#) on page 119

[:SOURce<hw>]:PHASe:REFerence

The command adopts the phase set with `SOURce:PHASe:ADJust` as the current phase.

- Example:** PHAS 0.1RAD
changes the phase by 0.1 RAD relative to the current phase.
PHAS:REF
adopts the set phase as the current phase.

Usage: Event

Manual control: See ["Reset Delta Phase Display - RF Signal"](#) on page 119

7.13.17 SOURce:PM Subsystem

The PM subsystem contains the commands for checking the phase modulation. The settings for the internal modulation source (LF generator) are made in the [SOURce:LFOuTput](#) subsystem.

For information about the required options, see [chapter 5.4.4, "Phase Modulation \(PhiM\)"](#), on page 223.

[:SOURce<hw>]:PM[:DEViation]	561
[:SOURce<hw>]:PM:EXTernal:COUPling	562
[:SOURce<hw>]:PM:EXTernal:DEViation	562
[:SOURce<hw>]:PM:EXTernal:DIGital:BFORmat	563
[:SOURce<hw>]:PM:INTernal<ch>:DEViation	563
[:SOURce<hw>]:PM:INTernal:SOURce	563
[:SOURce<hw>]:PM:MODE	564
[:SOURce<hw>]:PM:SENSitivity?	564
[:SOURce<hw>]:PM:SOURce	565
[:SOURce<hw>]:PM:STATe	565

[:SOURce<hw>]:PM[:DEViation] <Deviation>

The command sets the modulation deviation of the phase modulation in RAD. The maximal deviation depends on the RF frequency set and the selected modulation mode (see data sheet).

The deviation of the internal source must not exceed the deviation of the external source in case of modulation source "Int+Ext" (`PM:SOURce INT,EXT`).

Parameters:

<Deviation> float
 Range: 0 to 20
 Increment: See data sheet
 *RST: 1
 Default unit: RAD

Example:

PM 5
 sets the PM modulation deviation to 5 RAD

Usage:

SCPI confirmed

Options:

Option R&S SMA-B20 or R&S SMA-B22

Manual control:

See "[PhiM Deviation](#)" on page 225

[[:SOURce<hw>]:PM:EXTernal:COUPling <Coupling>

The command selects the coupling mode for the external modulation input in the case of phase modulation.

Parameters:

<Coupling> AC | DC
AC
 The DC voltage component is disconnected from the modulation signal.
DC
 The modulation signal is not changed.
 *RST: AC

Example:

PM:EXT:COUP AC
 selects the coupling mode AC for external phase modulation.

Usage:

SCPI confirmed

Options:

Option R&S SMA-B20 or R&S SMA-B22

Manual control:

See "[Mod External Coupling](#)" on page 227

[[:SOURce<hw>]:PM:EXTernal:DEVIation <Deviation>

The command sets the modulation deviation in case of external phase modulation in RAD. The maximal deviation depends on the RF frequency set and the selected modulation mode (see data sheet).

Parameters:

<Deviation> float
 Range: 0 to 20
 Increment: See data sheet
 Default unit: RAD

Example: `PM 5`
sets the PM modulation deviation for external phase modulation of 5 RAD.

Usage: SCPI confirmed

Options: Option R&S SMA-B20 or R&S SMA-B22

[:SOURce<hw>]:PM:EXTernal:DIGital:BFORmat <Bformat>

The command selects the binary format for external digital phase modulation.

Parameters:

<Bformat> BOFFset | DCODE

Example: `PM:EXT:DIG:BFOR BOFF`
selects binary format binary offset.

Usage: SCPI confirmed

Options: Option R&S SMA-B20 or R&S SMA-B22

[:SOURce<hw>]:PM:INTernal<ch>:DEViation <Deviation>

The command selects the deviation for the two phase modulation signals. The sum of the two values must not exceed the overall modulation deviation set with command `SOURce:PM:DEViation`.

Parameters:

<Deviation> float
Range: 0 to 20
*RST: 0.5 RAD

Example: `PM:INT1:DEV 20KHZ`
selects a deviation of 10 RAD for LF generator 1.

Options: Option R&S SMA-B20 or R&S SMA-B22; Option R&S SMA-K24

Manual control: See "[Deviation 1/Deviation 2](#)" on page 226

[:SOURce<hw>]:PM:INTernal:SOURce <Source>

Selects which internal modulation source is used. The available selection depends on the options fitted.

Parameters:

<Source> LF1 | LF2 | LF12 | NOISe | LF1Noise | LF2Noise

Example: `PM:INT:SOUR LF2N`
selects LF generator 2 and noise as internal modulation sources

Usage: SCPI confirmed

Options: Option R&S SMA-B20 or R&S SMA-B22; Option R&S SMA-K24 for selections other than LF1

Manual control: See "[Internal Source](#)" on page 226

[[:SOURce<hw>]:PM:MODE <Mode>

The command selects the mode for the phase modulation.

Parameters:

<Mode>

HBANdwidth | HDEVIation | LNOise

HBANdwidth

The maximum range for modulation bandwidth is available. However, phase noise is increased for low frequencies. The range for PhiM deviation is limited. This mode is recommended for high modulation frequencies.

HDEVIation

The maximum range for PhiM deviation is available. Phase noise is improved for low frequencies. The range for modulation frequency is limited (see data sheet). This mode is recommended for low modulation frequencies and/or high PhiM deviation.

LNOise

Phase modulation with phase noise and spurious characteristics close to CW mode. The range for modulation bandwidth and PM deviation is limited (see data sheet)

*RST: HBANdwidth

Example:

PM:MODE LNO

selects Low Noise mode for external phase modulation.

Usage:

SCPI confirmed

Options:

Option R&S SMA-B20 or R&S SMA-B22

Manual control:

See "[PhiM Mode](#)" on page 225

[[:SOURce<hw>]:PM:SENSitivity?

The command queries the input sensitivity of the EXT MOD input in RAD/V. The command is only effective if the external modulation source is selected (SOUR:PM:SOUR EXT). The returned value depends on the modulation deviation setting (SOUR:PM:DEVIation). This value is assigned to the voltage value for full modulation of the input.

Return values:

<Sensitivity>

float

Example:

PM:DEV 1

sets a modulation deviation of 1RAD.

PM:SENS?

queries the input sensitivity at the EXT MOD input.

Response: 1

since the voltage value for full modulation is 1V, the resulting sensitivity is precisely 1RAD/V.

Usage:	Query only SCPI confirmed
Options:	Option R&S SMA-B20 or R&S SMA-B22
Manual control:	See " PhiM Sensitivity " on page 227

[:SOURce<hw>]:PM:SOURce <Source>

The command selects the modulation source for phase modulation.

Parameters:

<Source> INTernal | EXTernal | INT,EXT | EDIGital

INTernal

INT is the LF generator. The frequency of the internal modulation signal can be set in the `SOURce:LFOutput` subsystem.

EXTernal

The external analog signal is input at the FM/PM EXT connector.

INT,EXT

Internal and external modulation source can be selected at the same time.

EDIGital

The external digital signal is input at the AUX I/O connector.

*RST: INTernal

Example:

`PM:SOUR INT`

selects the internal modulation source.

`PM:INT:SOUR LF2`

selects the LF generator 2 as internal modulation source.

Usage:	SCPI confirmed
Options:	Option R&S SMA-B20 or R&S SMA-B22
Manual control:	See " PhiM Source " on page 225

[:SOURce<hw>]:PM:STATe <State>

The command activates/deactivates phase modulation. Activation of phase modulation deactivates frequency modulation.

Parameters:

<State> 0 | 1 | OFF | ON

*RST: OFF

Example:

`PM:STAT ON`

activates PM modulation.

Usage:	SCPI confirmed
Options:	Option R&S SMA-B20 or R&S SMA-B22
Manual control:	See " State " on page 225

7.13.18 SOURce:POWer Subsystem

This subsystem contains the commands for setting the output level, level control and level correction of the RF signal.

Other units can also be used instead of dBm:

- by entering the unit directly after the numerical value (example :POW 0.5V)
- by changing the DEFault unit in the UNIT system (see the command :UNIT:POWer).

[:SOURce<hw>]:POWer:ALC:OMODE.....	566
[:SOURce<hw>]:POWer:ALC:SONCe.....	567
[:SOURce<hw>]:POWer:ALC[:STATe].....	567
[:SOURce<hw>]:POWer:ATTenuation:RFOff:MODE.....	567
[:SOURce<hw>]:POWer[:LEVel][:IMMediate][:AMPLitude].....	568
[:SOURce<hw>]:POWer[:LEVel][:IMMediate]:OFFSet.....	569
[:SOURce<hw>]:POWer[:LEVel][:IMMediate]:RCL.....	569
[:SOURce<hw>]:POWer:LIMit[:AMPLitude].....	570
[:SOURce<hw>]:POWer:MANual.....	570
[:SOURce<hw>]:POWer:MODE.....	571
[:SOURce<hw>]:POWer:POWer.....	572
[:SOURce<hw>]:POWer:SPC:CRANge.....	573
[:SOURce<hw>]:POWer:SPC:DELay.....	573
[:SOURce<hw>]:POWer:SPC:PEAK.....	573
[:SOURce<hw>]:POWer:SPC:SElect.....	574
[:SOURce<hw>]:POWer:SPC:STATe.....	574
[:SOURce<hw>]:POWer:SPC:TARGet.....	574
[:SOURce<hw>]:POWer:STARt.....	574
[:SOURce<hw>]:POWer:STEP[:INCRement].....	575
[:SOURce<hw>]:POWer:STEP:MODE.....	575
[:SOURce<hw>]:POWer:STOP.....	576

[:SOURce<hw>]:POWer:ALC:OMODE <OffMode>

The command sets the level control mode which becomes active when automatic level control is deactivated (ALC Off).

Parameters:

<OffMode> SHOLd
SHOLd
 Level control is activated briefly if the level or frequency changes ("ALC Off Sample & Hold").
 *RST: SHOLd

Example:

```
POW:ALC OFF
deactivates automatic level control for RF output A.
POW:ALC:OMOD SHOL
level control is briefly activated if the frequency or level changes.
```

[:SOURce<hw>]:POWER:ALC:SONCe

The command briefly activates level control for correction purposes.

Example: POW:ALC OFF
deactivates automatic level control for RF output A.
 POW:ALC:SONC
 level control is performed once only.

Usage: Event

Manual control: See "[Search Once - ALC](#)" on page 134

[:SOURce<hw>]:POWER:ALC[:STATe] <State>

The command activates/deactivates automatic level control.

Parameters:

<State> ON | OFF | AUTO

ON

Internal level control is permanently activated.

OFF

Internal level control is deactivated; Sample & Hold mode is activated.

AUTO

Internal level control is activated/deactivated automatically depending on the operating state.

*RST: AUTO

Example: POW:ALC ON
activates automatic level control for RF output A.

Manual control: See "[State - ALC](#)" on page 134

[:SOURce<hw>]:POWER:ATTenuation:RFOff:MODE <Mode>

Selects the attenuator mode, when the RF signal is switched off.

The setting of the RF OFF mode is not affected by an instrument preset (PRESET key), *RST and the "Save/Recall" function. This parameter is influenced only by the [Factory Preset](#).

Parameters:

<Mode>

UNCHanged | FATTenuation

UNCHanged

Freezes the setting of the attenuator when RF is switched off. The attenuator is only activated when RF is switched on.

This setting recommended if a constant VSWR (**V**oltage **S**tanding **W**ave **R**atio) is required.

Furthermore, it provides fast and wear-free operation of the relay-switched high power bypass.

Furthermore, on instruments equipped with a high power option, it provides fast and wear-free operation of the relay-switched high power bypass.

FATTenuation

Sets attenuation to maximum when the RF signal is switched off.

This setting is recommended for applications that require a high level of noise suppression.

*RST: FATTenuation

Example:

```
SOUR:POW:ATT:RFOF:MODE FATT
```

sets the RF OFF attenuator to maximum.

Manual control:

See "RF OFF Mode" on page 130

[:SOURce<hw>]:POWer[:LEVel][:IMMediate][:AMPLitude] <Amplitude>

The command sets the RF output level in CW mode. In addition to numerical values, it is also possible to specify UP and DOWN. The level is then increased or decreased by the value specified under [SOURce<hw>]:POWer:STEP.

As with the **Level** value entered in the header, the OFFSet value is also taken into consideration with this command.

The specified value range is therefore only effective if :SOURce:POWer:OFFSet is set to 0. The value range for other OFFSet values can be calculated using the following formula:

Minimum level + OFFSet ... Maximum level + OFFSet

The keywords of this command are largely optional. Therefore, both the long and short form of the command are shown in the example.

Parameters:

<Amplitude>

Minimum level ... Maximum level

The value range for the level setting varies according to the instrument model.

The values are given in the data sheet.

Increment: 0.01 dB

*RST: -30 dBm

Default unit: dBm

Example: SOUR:POW:LEV:IMM:AMPL 15
 or
 :POW 15
 sets the RF level at output A to 15 dBm.

Usage: SCPI confirmed

Manual control: See "RF Level" on page 128

[:SOURce<hw>]:POWer[:LEVel][:IMMediate]:OFFSet <Offset>

Note: The level offset is also effective for level sweeps!

The command specifies the constant level offset of a downstream attenuator/amplifier. If a level offset is entered, the level entered with :POWer no longer corresponds to the RF output level.

The following correlation applies:

:POWer = RF output level + POWer:OFFSet.

Entering a level offset does not change the RF output level, but rather the query value of :POWer.

For more information, see "RF level vs. RF output level" on page 127.

Only dB is permitted as the unit here. The linear units (V, W, etc.) are not permitted.

The keywords of this command are largely optional. Therefore, both the long and short form of the command are shown in the example.

Parameters:

<Offset> float
 Range: -100 dB to 100 dB
 Increment: 0.01 dB
 *RST: 0 dB
 Default unit: dB

Example: SOURce:POWer:LEVel:IMMediate:OFFSet -10
 or
 POW:OFFS 10
 sets the RF level offset to 10 dB

Usage: SCPI confirmed

Manual control: See "Offset (Level)" on page 129

[:SOURce<hw>]:POWer[:LEVel][:IMMediate]:RCL <Rcl>

The command determines whether the current level is retained or whether the stored level setting is adopted when an instrument configuration is loaded.

*RST does not affect this setting.

Parameters:**<Rcl>** INCLude | EXCLude**INCLude**

The stored level is also loaded when a stored instrument configuration is loaded.

EXCLude

The RF level is not loaded when a stored instrument configuration is loaded. The current level is retained.

*RST: no default

Example:

```
POW:RCL INCL
```

the stored level is set if the Recall command is called.

Usage:

SCPI confirmed

Manual control:

See "[Exclude Level](#)" on page 111

[:SOURce<hw>]:POWER:LIMit[:AMPLitude] <Amplitude>

The command limits the maximum RF output level in CW and SWEEP mode. It does not influence the "Level" display or the response to the POW? query command.

The value is not affected by an instrument preset (PRESET key), *RST and the Save/Recall function. This parameter is influenced only by the factory preset (SYST:FPR) and its factory value is equal to the upper limit.

Parameters:**<Amplitude>** float**Minimum level ... Maximum level**

The value range for the level setting varies according to the instrument model.

The values are given in the data sheet.

Increment: 0.01 dB

*RST: 30 dBm

Default unit: dBm

Example:

```
SOURce:POWER:LIMit:AMPLitude 10
```

or

```
:POW:LIM 10
```

limits the RF level to maximum +10 dBm.

Usage:

SCPI confirmed

Manual control:

See "[Limit - RF Level](#)" on page 129

[:SOURce<hw>]:POWER:MANual <Manual>

In Sweep mode (:SOUR:POW:MODE SWE) the command sets the level for the next sweep step in the Step sweep mode (:SOUR:SWE:POW:MODE MAN). Here only level values between the settings [:SOUR]:POW:STAR and [:SOUR]:POW:STOP are permitted. Each sweep step is triggered by a separate :SOUR:POW:MAN command.

As with the "Level" value entered in the "RF Level" menu, the `OFFSet` value is also taken into consideration with this command.

The specified value range is therefore only effective if `:SOURce:POWer:OFFSet` is set to 0. The value range for other `OFFSet` values can be calculated using the following formula:

Minimum level + `OFFSet` ... Maximum level + `OFFSet`

Parameters:

<Manual>

float

Minimum level ... Maximum level

The value range for the level setting varies according to the instrument model

The values are given in the data sheet.

Increment: 0.01 dBm

*RST: -30 dBm

Default unit: dBm

Example:

`POW:SWE:MODE MAN`

sets the Step sweep mode for RF output A.

`POW:MAN -5 dBm`

sets an RF level of -5 dBm for the next setting in the Step sweep mode for RF output A.

`POW:MODE SWE`

sets the Level Sweep mode for RF output A.

`POW:MAN -5.5 dBm`

triggers the next sweep step with a level of -5.5 dBm.

Usage:

SCPI confirmed

Manual control:

See "[Current Level - Level Sweep](#)" on page 201

[:SOURce<hw>]:POWer:MODE <Mode>

The command sets the instrument operating mode and therefore also the commands used to set the output level.

Parameters:

<Mode>

CW | FIXed | SWEep

CW|FIXed

The instrument operates at a constant level. CW and FIXed are synonyms. The output level is set with :SOURce:POWer.

SWEep

The instrument operates in SWEep mode.

The level is set using the commands SOURce:POWer:START; STOP; MANual.

LIST

The instrument processes a list of frequency and level settings. The List mode settings are made in the [SOURce:LIST Subsystem](#) subsystem.

The setting SOURce:POWer:MODE LIST also sets the command SOURce:FREQuency:MODE automatically to LIST.

*RST: CW

Example:

POW:MODE SWEep

sets the SWEep mode. The settings under SOURce:POW:START; STOP; MANual become effective.

Usage:

SCPI confirmed

Manual control:

See "[State - Level Sweep](#)" on page 197

[:SOURce<hw>]:POWer:POWer <Power>

Sets the RF level of the RF output connector.

The level entered with this command corresponds to the level at the RF output, i.e. any offset entry is not taken into consideration.

Note: The SCPI command [:SOURce<hw>]:POWer[:LEVel] [:IMMediate] [:AMPLitude] sets the level of the "Level" display, i.e. the level containing offset.

Parameters:

<Power>

Minimum level ... Maximum level

The value range for the level setting varies according to the instrument model.

The values are given in the data sheet.

Increment: 0.01 dB

*RST: -30 dBm

Default unit: dBm

Example:

SOUR:POW:POW 15

sets the RF level at output to 15 dBm.

Manual control:

See "[Amplitude](#)" on page 129

[[:SOURce<hw>]:POWER:SPC:CRANge <PowCntrlCRange>

Defines the capture range of the power control system.

Within the range:

Target Level +/- Catch Range

the power control locks and tries to achieve the target level. Readings outside the range are not considered.

Parameters:

<PowCntrlCRange> float
Range: 0 to 50
Increment: 0.01
*RST: 30
Default unit: dB

Example: POW:SPC:CRAN 15
sets the capture range to +/- 15 dB.

Manual control: See "[Catch Range +/-](#)" on page 137

[[:SOURce<hw>]:POWER:SPC:DELay <PowCntrlDelay>

Defines a waiting period between the level adjustment of the generator and the next measurement of the power sensor.

Parameters:

<PowCntrlDelay> integer
Range: 0 to 1000
Increment: 1
*RST: 0

Example: :POW:SPC:DEL 2 ms
the sensor starts the next reading 2 ms after the level adjustment.

Manual control: See "[Delay Time](#)" on page 137

[[:SOURce<hw>]:POWER:SPC:PEAK <PowCntrlPeak>

Activates power control by means of the peak power values, provided the power sensor supports this function.

Parameters:

<PowCntrlPeak> 0 | 1 | OFF | ON
*RST: 0

Example: POW:SPC:PEAK ON
uses the measured peak power for power control.

Manual control: See "[Use Peak Power](#)" on page 137

[[:SOURce<hw>]:POWER:SPC:SElect <PowCntrlSelect>

Defines the currently selected sensor to be used for power control.

Parameters:

<PowCntrlSelect> SENS1 | SENS2 | SENS3 | SENS4
*RST: SENS1

Example:

POW:SPC:SEL SENS2
selects the sensor connected to a second USB interface for power control.

Manual control: See "[Sensor](#)" on page 135

[[:SOURce<hw>]:POWER:SPC:STATe <PowCntrlState>

Activates power control using the selected sensor. The control loop periodically adjusts the generator output. After switching off, the running loop is completed.

Parameters:

<PowCntrlState> 0 | 1 | OFF | ON
*RST: 0

Example:

POW:SPC:STAT ON
activates power control.

Manual control: See "[State](#)" on page 136

[[:SOURce<hw>]:POWER:SPC:TARGet <PowCntrlTarget>

Sets the nominal level expected at the input of the sensor. To define the unit of the power value, use command [SENSe<ch>:UNIT\[:POWER\]](#) on page 438.

Parameters:

<PowCntrlTarget> float
Range: -50 to 30
Increment: 0.01
*RST: -10

Example:

SENS:UNIT dBm
selects unit dBm for setting the target level value.
POW:SPC:TARG -10
sets -10 dBm target level.

Manual control: See "[Target Level](#)" on page 137

[[:SOURce<hw>]:POWER:STARt <Start>

The command sets the RF start level in Sweep mode.

As with the "Level" value entered in the "RF Level" menu, the `OFFSet` value is also taken into consideration with this command.

The specified value range is therefore only effective if `:SOURce:POWer:OFFSet` is set to 0. The value range for other `OFFSet` values can be calculated using the following formula:

Minimum level + `OFFSet` ... Maximum level + `OFFSet`

Parameters:

<Start> float

Minimum level ... Maximum level

The value range for the level setting varies according to the instrument model. The values are given in the data sheet.

Increment: 0.01 dB

*RST: -30 dBm

Default unit: dBm

Example:

`POW:STAR -20 dBm`

sets the start level for the level sweep to -15 dBm for RF output A.

Usage:

SCPI confirmed

Manual control:

See "[Start Level - Level Sweep](#)" on page 200

`[:SOURce<hw>]:POWer:STEP[:INCRement] <Increment>`

The command sets the step width for the level setting if `UP` and `DOWN` are used as the level values and variation mode `:SOUR:POW:STEP:MODE USER` is selected. The command is linked to setting "Variation Step" for manual control, i.e. the command also sets the step width of the rotary knob for "Variation Active On".

Parameters:

<Increment> float

Range: 0 dB to 100 dB

Increment: 0.01 dB

*RST: 1 dB

Default unit: dB

Example:

`SOURce:POWer:STEP:INCRement 2`

or

`POW:STEP 2`

sets the step width for entering the RF level to 2 dB.

Manual control:

See "[Variation Step](#)" on page 131

`[:SOURce<hw>]:POWer:STEP:MODE <Mode>`

This command activates (`USER`) or deactivates (`DECimal`) the user-defined step width used when varying the level value with the level values `UP/DOWN`. The command is linked to setting "Variation Active" for manual control, i.e. the command also activates/deactivates the user-defined step width used when varying the level value with the rotary knob.

Parameters:

<Mode> DECimal | USER
 *RST: DECimal

Example:

POW:STEP 2
 sets the step width for the level setting to 2 dB.
 POW:STEP:MODE USER
 activates this step width for level variation with the rotary knob (manual control) and with level values UP/DOWN (remote control).

Manual control: See "[Variation Active](#)" on page 131

[:SOURce<hw>]:POWer:STOP <Stop>

The command sets the stop level in Sweep mode.

As with the **Level** value entered in the **RF Level** menu, the **OFFSet** value is also taken into consideration with this command.

The specified value range is therefore only effective if :SOURce:POWer:OFFSet is set to 0. The value range for other OFFset values can be calculated using the following formula:

Minimum level + OFFSet ... Maximum level + OFFSet

Parameters:

<Stop> float
Minimum level ... Maximum level
 The value range for the level setting varies according to the instrument model.
 The values are given in the data sheet.
 Increment: 0.01 dB
 *RST: -10 dBm
 Default unit: dBm

Example:

POW:STOP 3
 sets the stop level for the level sweep to 3 dBm for RF output A.

Usage: SCPI confirmed

Manual control: See "[Stop Level - Level Sweep](#)" on page 201

7.13.19 SOURce:PULM Subsystem

This subsystem contains the commands for setting the pulse modulation.

The LF generator is used as the internal modulation source. The pulse frequency of the internal rectangular signal is therefore set in the SOURce:LFOuTput subsystem.

The external signal is input at the PULSE EXT connector. The connector can be used as trigger input for internal pulse modulation. The polarity and input impedance of the con-

connector can be selected. The pulse modulation signal is output at the PULSE VIDEO connector.

<code>[SOURce<hw>]:PULM:DELay</code>	577
<code>[SOURce<hw>]:PULM:DOUBle:DELay</code>	578
<code>[SOURce<hw>]:PULM:DOUBle:STATe</code>	578
<code>[SOURce<hw>]:PULM:DOUBle:WIDTh</code>	578
<code>[SOURce<hw>]:PULM:MODE</code>	579
<code>[SOURce<hw>]:PULM:OUTPut:SYNc[:STATe]</code>	579
<code>[SOURce<hw>]:PULM:PERiod</code>	579
<code>[SOURce<hw>]:PULM:POLarity</code>	580
<code>[SOURce<hw>]:PULM:SOURce</code>	580
<code>[SOURce<hw>]:PULM:STATe</code>	581
<code>[SOURce<hw>]:PULM:TRAIIn:CATalog?</code>	581
<code>[SOURce<hw>]:PULM:TRAIIn:DELete</code>	582
<code>[SOURce<hw>]:PULM:TRAIIn:OFFTime</code>	582
<code>[SOURce<hw>]:PULM:TRAIIn:OFFTime:POINts?</code>	583
<code>[SOURce<hw>]:PULM:TRAIIn:ONTime</code>	583
<code>[SOURce<hw>]:PULM:TRAIIn:ONTime:POINts?</code>	584
<code>[SOURce<hw>]:PULM:TRAIIn:REPetition</code>	584
<code>[SOURce<hw>]:PULM:TRAIIn:REPetition:POINts?</code>	585
<code>[SOURce<hw>]:PULM:TRAIIn:SELect</code>	585
<code>[SOURce<hw>]:PULM:TRIGger:EXTernal:GATE:POLarity</code>	586
<code>[SOURce<hw>]:PULM:TRIGger:EXTernal:IMPedance</code>	586
<code>[SOURce<hw>]:PULM:TRIGger:EXTernal:SLOPe</code>	586
<code>[SOURce<hw>]:PULM:TRIGger:MODE</code>	587
<code>[SOURce<hw>]:PULM:TRAIIn:DEXChange:AFILe:CATalog?</code>	587
<code>[SOURce<hw>]:PULM:TRAIIn:DEXChange:AFILe:EXTension</code>	588
<code>[SOURce<hw>]:PULM:TRAIIn:DEXChange:AFILe:SELect</code>	588
<code>[SOURce<hw>]:PULM:TRAIIn:DEXChange:AFILe:SEParator:COLumn</code>	589
<code>[SOURce<hw>]:PULM:TRAIIn:DEXChange:AFILe:SEParator:DECimal</code>	589
<code>[SOURce<hw>]:PULM:TRAIIn:DEXChange:EXECute</code>	590
<code>[SOURce<hw>]:PULM:TRAIIn:DEXChange:MODE</code>	590
<code>[SOURce<hw>]:PULM:TRAIIn:DEXChange:SELect</code>	591
<code>[SOURce<hw>]:PULM:WIDTh</code>	591

`[SOURce<hw>]:PULM:DELay` <Delay>

The command sets the pulse delay. The pulse delay determines the time that elapses after a trigger event before pulse modulation starts. The pulse delay is not effective for double pulse generation.

Parameters:

<Delay> float
 Range: 10 ns to 100 s
 Increment: 5 ns
 *RST: 10 ns
 Default unit: ns

Example:

`PULM:DEL 13 us`
 13 us elapse after a trigger before the first pulse is generated.

Options: R&S SMA-K23 (Pulse Generator)

Manual control: See "[Pulse Delay - Pulse Generator](#)" on page 303

[[:SOURce<hw>]:PULM:DOUBLE:DELay <Delay>

The command sets the delay from the start of the first pulse to the start of the second pulse.

Parameters:

<Delay> float
 Range: 10 ns to 100 s
 Increment: 5 ns
 *RST: 3 us
 Default unit: ns

Example:

PULM:DOUB:DEL 22 us
 22 us elapse between the beginning of the first pulse and the beginning of the second pulse in double-pulse mode.

Options: R&S SMA-K23 (Pulse Generator)

Manual control: See "[Double Pulse Delay - Pulse Generator](#)" on page 303

[[:SOURce<hw>]:PULM:DOUBLE:STATe <State>

The command enables/disables double pulse generation. The two pulses are generated in one pulse period.

Parameters:

<State> 0 | 1 | OFF | ON
 *RST: OFF

Example:

PULM:DOUB:STAT ON
 double-pulse mode is enabled.

Options: R&S SMA-K23 (Pulse Generator)

[[:SOURce<hw>]:PULM:DOUBLE:WIDTh <Width>

The command sets the width of the second pulse in case of double pulse generation.

Parameters:

<Width> float
 Range: 5 ns to 100 s
 Increment: 5 ns
 *RST: 3 us
 Default unit: us

Example:

PULM:DOUB:WIDT 33 us
 sets a width of 33 us for the second pulse.

Options: R&S SMA-K23 (Pulse Generator)

Manual control: See "[Double Pulse Width - Pulse Generator](#)" on page 303

[:SOURce<hw>]:PULM:MODE <Mode>

Sets the mode of the pulse generator.

Parameters:

<Mode>

SINGle | DOUBle | PTRain

SINGle

Enables single pulse generation.

DOUBle

Enables double pulse generation. The two pulses are generated in one pulse period.

PTRain

A user-defined pulse train is generated. The pulse train is defined by value pairs of on and off times that can be entered in a pulse train list.

*RST: SINGle

Example:

PULM:MODE DOUB

enables double pulse generation.

Manual control: See "[Pulse Mode - Pulse Generator](#)" on page 302

[:SOURce<hw>]:PULM:OUTPut:SYNC[:STATe] <Sync>

Configures the signal at the SIGNAL VALID connector.

Parameters:

<Sync>

OFF | ON | 1 | 0

ON

Generates a single pulse at the beginning of a pulse sequence, e.g. to synchronize pulse modulation.

OFF

Returns the validity of the RF signal at the output:

1 (high), while the signal settles.

0 (low), when it is stable (valid).

*RST: OFF

Example:

PULM:OUTP:SYNC ON

uses the signal for synchronizing the pulse modulation.

[:SOURce<hw>]:PULM:PERiod <Period>

The command sets the period of the generated pulse. The period determines the repetition frequency of the internal signal.

Parameters:

<Period> float
 Range: 5 us | 20 ns to 100 s
 Increment: 1us | 5 ns
 *RST: 10 us
 Default unit: us

Example:

PULM:PER 220 us
 the pulse period is 220 us.

Options:

The enhanced features require option R&S SMA-K23 (Pulse Generator)

Manual control:

See "[Pulse Period - Pulse Generator](#)" on page 302

[:SOURce<hw>]:PULM:POLarity <Polarity>

The command sets the polarity between modulating and modulated signal. This command is only effective for an external modulation signal.

Parameters:

<Polarity> NORMal | INVerted
NORMal
 The RF signal is suppressed during the pulse pause.
INVerted
 The RF signal is suppressed during the pulse.
 *RST: NORMal

Example:

PULM:SOUR EXT
 selects the external modulation source.

Example:

PULM:POL INV
 selects inverted polarity.

Manual control:

See "[Polarity](#)" on page 231

[:SOURce<hw>]:PULM:SOURce <Source>

The command selects the source for pulse modulation.

Parameters:

<Source>

INTernal | EXTernal

INTernal

Without option R&S SMA-K23:

The internally generated rectangular signal is used for the pulse modulation. The frequency of the internal signal can be set in the `SOURce:LFOutput` subsystem.

With option R&S SMA-K23:

If option R&S SMA-K23 is installed, the characteristics of the generated pulse can be set in a wide range, and double pulse generation is possible.

EXTernal

The signal applied externally via the EXT MOD connector is used for the pulse modulation.

*RST: INTernal

Example:

PULM:SOUR INT

selects the internal modulation source.

PULM:STAT ON

activates the pulse modulation.

Usage:

SCPI confirmed

Manual control:

See "Source" on page 230

[:SOURce<hw>]:PULM:STATe <State>

The command activates/deactivates the pulse modulation.

Parameters:

<State>

0 | 1 | OFF | ON

*RST: OFF

Example:

PULM:STAT ON

activates pulse modulation with the modulation source selected under `SOURce:PULM:SOURce`.

Usage:

SCPI confirmed

Manual control:

See "State" on page 230

[:SOURce<hw>]:PULM:TRAIin:CATalog?

The command requests a list of available pulse train files. The individual pulse train files are separated by commas.

The files are stored with the fixed file extensions `*.pulstrn` in a directory of the user's choice. The directory applicable to the commands is defined with the command

`MMEMoRY:CDIR`.

Return values:

<Catalog>

string

Example: `MMEM:CDIR 'var/lists/pulsetrain'`
 selects the directory for the pulse train files.
`PULM:TRA:CAT?`
 queries the available files.
 Response: 'P_CONS', 'P_INCR', 'P_DECR'
 the lists P_CONS, P_INCR and P_DECR are available.

Usage: Query only

Options: R&S SMA-K27 (Pulse Train)

Manual control: See "[Pulse Train Data – Pulse Generator](#)" on page 308

[[:SOURce<hw>]:PULM:TRAI:DELete <Delete>

The command deletes the specified pulse train file.

The files are stored with the fixed file extensions `*.pulstrn` in a directory of the user's choice. The directory applicable to the command is defined with the command `MMEMoRY:CDIR`. To access the files in this directory, only the file name has to be given without the path and the file extension.

Setting parameters:

<Delete> <list file name>

Example: `MMEM:CDIR 'var/lists/pulsetrain'`
 selects the directory for the pulse train files.
`PULM:TRA:DEL 'P_FIVE'`
 deletes the list P_FIVE

Usage: Setting only

Options: R&S SMA-K27 (Pulse Train)

Manual control: See "[Pulse Train Data – Pulse Generator](#)" on page 308

[[:SOURce<hw>]:PULM:TRAI:OFFTime <Offtime>

The command fills the Offtime part of the selected file with data.

*RST does not affect data lists.

Parameters:

<Offtime> Offtime#1{, Offtime#2, ...} | binary block data

The data can be given either as a list of numbers (list can be of any length and list entries must be separated by commas) or as binary block data.

When block data is transferred, 8 (4) bytes are always interpreted as a floating-point number with double accuracy (see the command `FORMat:DATA`).

The maximum length is 1023 values.

Range: 5ns to 5ms

- Example:** MMEM:CDIR 'var/lists/pulsetrain'
selects the directory for the pulse train files.
PULM:TRA:SEL 'P_INCR'
selects P_INCR for editing. P_INCR is created if it does not yet exist.
PULM:TRA:OFFT 10ns,15ns,40ns,...
specifies the offtime values in P_INCR. If the list already contains data, it is overwritten.
- Options:** R&S SMA-K27 (Pulse Train)
- Manual control:** See ["Edit Pulse Train Data"](#) on page 308

[:SOURce<hw>]:PULM:TRAI:OFFTime:POINts?

The command queries the length (in points) of the offtime component of the selected list.

Return values:

<Points> float

- Example:** MMEM:CDIR 'var/lists/pulsetrain'
selects the directory for the pulse train files.
PULM:TRA:SEL 'P_INCR'
selects P_INCR for editing. P_INCR is created if it does not yet exist.
PULM:TRA:OFFT:POIN?
queries the number of frequency values in P_INCR
Response: 7
P_INCR has 7 offtime entries.

Usage: Query only

Options: R&S SMA-K27 (Pulse Train)

[:SOURce<hw>]:PULM:TRAI:ONTime <Ontime>

The command fills the Ontime part of the selected file with data.

Parameters:

- <Ontime> Onime#1{, Onime#2, ...} | binary block data
The data can be given either as a list of numbers (list can be of any length and list entries must be separated by commas) or as binary block data.
When block data is transferred, 8 (4) bytes are always interpreted as a floating-point number with double accuracy (see the command `FORMat:DATA`).
The maximum length is 1023 values.
Range: 5ns to 5ms

- Example:** `MMEM:CDIR 'var/lists/pulsetrain'`
selects the directory for the pulse train files.
`PULM:TRA:SEL 'P_INCR'`
selects P_INCR for editing. P_INCR is created if it does not yet exist.
`PULM:TRA:ONT 10ns,15ns,40ns,...`
specifies the ontime values in P_INCR. If the list already contains data, it is overwritten.
- Options:** R&S SMA-K27 (Pulse Train)
- Manual control:** See ["Edit Pulse Train Data"](#) on page 308

[:SOURce<hw>]:PULM:TRAI:ONTIME:POINTs?

The command queries the length (in points) of the ontime component of the selected list.

Return values:

<Points> float

- Example:** `MMEM:CDIR 'var/lists/pulsetrain'`
selects the directory for the pulse train files.
`PULM:TRA:SEL 'P_INCR'`
selects P_INCR for editing. P_INCR is created if it does not yet exist.
`PULM:TRA:ONT:POIN?`
queries the number of frequency values in P_INCR
Response: 7
P_INCR has 7 ontime entries.

Usage: Query only

Options: R&S SMA-K27 (Pulse Train)

[:SOURce<hw>]:PULM:TRAI:REPETITION <Repetition>

The command sets the number of repetitions for each ontime/offtime value pair. The maximum number of repetitions for all value pairs is 1023 values.

*RST does not affect data lists.

Parameters:

<Repetition> Repetition#1{, Repetition#2, ...}
Range: 1 to max

- Example:** `MMEM:CDIR 'var/lists/pulsetrain'`
selects the directory for the pulse train files.
- `PULM:TRA:SEL 'P_INCR'`
selects P_INCR for editing. P_INCR is created if it does not yet exist.
- `PULM:TRA:ONT 10ns,15ns,40ns,...`
specifies the ontime values in P_INCR. If the list already contains data, it is overwritten.
- `PULM:TRA:OFFT 10ns,15ns,40ns,...`
specifies the offtime values in P_INCR. If the list already contains data, it is overwritten.
- `PULM:TRA:REP 10,15,40,...`
specifies the number of repetitions for each value pair.
- Options:** R&S SMA-K27 (Pulse Train)
- Manual control:** See ["Edit Pulse Train Data"](#) on page 308

[:SOURce<hw>]:PULM:TRAI:REP:POINts?

The command queries the length (in points) of the repetition component of the selected list.

Return values:

<Points> float

- Example:** `MMEM:CDIR 'var/lists/pulsetrain'`
selects the directory for the pulse train files.
- `PULM:TRA:SEL 'P_INCR'`
selects P_INCR for editing. P_INCR is created if it does not yet exist.
- `PULM:TRA:REP:POIN?`
queries the number of repetition values in P_INCR
- Response: 7
P_INCR has 7 repetition entries.

Usage: Query only

Options: R&S SMA-K27 (Pulse Train)

[:SOURce<hw>]:PULM:TRAI:SElect <Select>

The command selects the specified pulse train file. If a new file is to be created, the name can be entered here. The file is created if it does not yet exist. The file selected here is available for the further processing steps (editing) and is used in the instrument when the pulse train mode is activated.

The files are stored with the fixed file extensions *.pulstrn in a directory of the user's choice. The directory applicable to the command is defined with the command `MMEMory:CDIR`.

*RST does not affect data lists.

Parameters:**<Select>** string**Example:**

```
MMEM:CDIR 'var/lists/pulsetrain'
```

 selects the directory for the pulse train files.

```
PULM:TRA:SEL 'P_INCR'
```

selects P_INCR for editing. P_INCR is created if it does not yet exist.

Options:

R&S SMA-K27 (Pulse Train)

Manual control:See ["Pulse Train Data – Pulse Generator"](#) on page 308
[[:SOURce<hw>]:PULM:TRIGger:EXTernal:GATE:POLarity <Polarity>

Selects the polarity of the Gate signal.

The signal is supplied via the PULSE EXT connector.

Parameters:
<Polarity> NORMAL | INVERTed
 *RST: NORMAL
Example:

```
PULM:TRIG:EXT:GATE:POL NORM
```

The pulse signal is generated while the gate signal is high.

Options:

R&S SMA-K23 (Pulse Generator)

Manual control:See ["Gate Input Polarity - Pulse Generator"](#) on page 307
[[:SOURce<hw>]:PULM:TRIGger:EXTernal:IMPedance <Impedance>

The command selects the impedance for external pulse trigger. The trigger is fed via the PULSE EXT input.

Parameters:
<Impedance> G50 | G10K
 *RST: G10K
Example:

```
SOUR:PULM:TRIG:EXT:IMP G50
```

selects 50 Ohm as the trigger impedance for the external pulse trigger.

Usage:

SCPI confirmed

Manual control:See ["Pulse External Input Impedance"](#) on page 307
[[:SOURce<hw>]:PULM:TRIGger:EXTernal:SLOPe <Slope>

The command sets the polarity of the active slope of an applied trigger at the PULSE EXT connector.

Parameters:

<Slope> POS | NEG
 *RST: POSitive

Example:

PULM:TRIG:EXT:SLOP NEG

The pulse generator is triggered on the negative slope of the external trigger signal.

Options:

R&S SMA-K23 (Pulse Generator)

Manual control:

See ["External Trigger Input Slope - Pulse Generator"](#) on page 306

[:SOURce<hw>]:PULM:TRIGger:MODE <Mode>

The command selects the trigger mode for pulse modulation.

Parameters:

<Mode> AUTO | EXTeRnal | EGATe

AUTO

The pulse modulation is generated continuously.

EXTeRnal

The pulse modulation is triggered by an external trigger event. The trigger signal is supplied via the PULSE EXT connector.

EGATe

The pulse modulation is gated by an external gate signal. The signal is supplied via the PULSE EXT connector.

*RST: AUTO

Example:

PULM:TRIG:MODE EXT

selects triggering by an external trigger event.

Usage:

SCPI confirmed

Options:

Option R&S SMA-K23 (Pulse Generator); (AUTO by default without this option)

Manual control:

See ["Trigger Mode - Pulse Generator"](#) on page 303

[:SOURce<hw>]:PULM:TRAIIn:DEXChange:AFILe:CATalog?

The command requests a list of available ASCII files for export/import of pulse train data. The individual files are separated by commas.

The ASCII files are stored with the fixed file extensions *.txt or *.csv in a directory of the user's choice. The directory applicable to the commands is defined with the command `MMEMoRy:CDIR`.

Return values:

<Catalog> string

Example: MMEM:CDIR `var/lists/pulsetrain/import`
 selects the directory for the ASCII files with ontime/offtime/repetition values.
 PULM:TRA:DEXC:AFIL:EXT TXT
 selects that ASCII files with extension *.txt are listed.
 PULM:TRA:DEXC:AFIL:CAT?
 queries the available files with extension *.txt.
 Response: 'train1','train2'
 the ASCII files train1.txt and train2.txt are available.

Usage: Query only

Options: R&S SMA-K27 (Pulse Train)

Manual control: See ["Select ASCII Source / Destination - Import/Export Pulse Train Files"](#) on page 310

[:SOURce<hw>]:PULM:TRAI:DEXChange:AFIL:EXTension <Extension>

The command selects the file extension of the ASCII file to be imported or exported. Selection TXT (text file) or CSV (Excel file) is available.

Parameters:

<Extension> TXT | CSV

*RST: TXT

Example: MMEM:CDIR `var/lists/pulsetrain/import`
 selects the directory for the ASCII files with ontime/offtime/repetition values.
 PULM:TRA:DEXC:AFIL:EXT TXT
 selects that ASCII files with extension *.txt are listed.
 PULM:TRA:DEXC:AFIL:CAT?
 queries the available files with extension *.txt.
 Response: 'train1','train2'
 the ASCII files train1.txt and train2.txt are available.

Options: R&S SMA-K27 (Pulse Train)

Manual control: See ["Extension – ASCII File Settings"](#) on page 310

[:SOURce<hw>]:PULM:TRAI:DEXChange:AFIL:SElect <Filename>

The command selects the ASCII file to be imported or exported.

The ASCII files are stored with the fixed file extensions *.txt or *.csv in a directory of the user's choice. The directory applicable to the commands is defined with the command MMEMory:CDIR.

Parameters:

<Filename> string

- Example:** `MMEM:CDIR 'var/lists/pulsetrain/import'`
selects the directory for the ASCII files with ontime/offtime/repetition values.
- `PULM:TRA:DEXC:MODE IMP`
selects that ASCII files with ontime/offtime/repetition values are imported and transferred into pulse train lists.
- `PULM:TRA:DEXC:AFIL:SEL 'train.csv'`
selects that ASCII file `train.csv` is imported.
- `PULM:TRA:DEXC:SEL 'train_imp'`
selects that the ASCII file `train.csv` is imported into pulse train list `train_imp`.
- Options:** R&S SMA-K27 (Pulse Train)
- Manual control:** See ["Select ASCII Source / Destination - Import/Export Pulse Train Files"](#) on page 310

[:SOURce<hw>]:PULM:TRAI:n:DEXChange:AFILe:SEParator:COLumn <Column>

Parameters:

<Column> TABulator | SEMicolon | COMMa | SPACe
*RST: SEMicolon

- Example:** `PULM:TRA:DEXC:MODE EXP`
selects that the pulse train list is exported into an ASCII file.
- `MMEM:CDIR 'var/lists/pulsetrain/import'`
selects the directory for the ASCII files with ontime/offtime/repetition values.
- `PULM:TRA:DEXC:AFIL:SEL 'train.csv'`
selects ASCII file `train.csv` as destination for the pulse train list data.
- `PULM:TRA:DEXC:AFIL:SEP:COL TAB`
the ontime/offtime/repetition values are separated by a tabulator.
- `PULM:TRA:DEXC:AFIL:SEP:DEC DOT`
selects the decimal separator dot.
- `PULM:TRA:DEXC:SEL 'train_imp'`
selects that the pulse train list `train_imp` is imported into ASCII file `train.csv`.
- Options:** R&S SMA-K27 (Pulse Train)
- Manual control:** See ["Column Separator- ASCII File Settings"](#) on page 310

[:SOURce<hw>]:PULM:TRAI:n:DEXChange:AFILe:SEParator:DECimal <Decimal>

The command selects the decimal separator used in the ASCII data between '.' (decimal point) and ',' (comma) with floating-point numerals.

Parameters:

<Decimal> DOT | COMMa
*RST: DOT

- Example:** PULM:TRA:DEXC:MODE EXP
selects that the pulse train list is exported into an ASCII file.
MMEM:CDIR 'var/lists/pulsetrain/import'
selects the directory for the ASCII files with fontime/offtime/repetition values.
PULM:TRA:DEXC:AFIL:SEL 'train.csv'
selects ASCII file train.csv as destination for the pulse train list data.
PULM:TRA:DEXC:AFIL:SEP:COL TAB
the ontime/offtime/repetition values are separated by a tabulator.
PULM:TRA:DEXC:AFIL:SEP:DEC DOT
selects the decimal separator dot.
PULM:TRA:DEXC:SEL 'train_imp'
selects that the pulse train list train_imp is imported into ASCII file train.csv.
- Options:** R&S SMA-K27 (Pulse Train)
- Manual control:** See "[Decimal Point - ASCII File Settings](#)" on page 310

[:SOURce<hw>]:PULM:TRAI:n:DEXChange:EXECute

The command starts the export or import of the selected file. When import is selected, the ASCII file is imported as pulse train list. When export is selected, the pulse train list is exported into the selected ASCII file.

- Example:** PULM:TRA:DEXC:MODE IMP
selects that ASCII files with ontime/offtime/repetition values are imported and transferred into pulse train lists.
MMEM:CDIR 'var/lists/pulsetrain/import'
selects the directory for the ASCII files withontime/offtime/repetition values.
PULM:TRA:DEXC:AFIL:SEL 'train.csv'
selects that ASCII file train.csv is imported.
PULM:TRA:DEXC:SEL 'train_imp'
selects that the ASCII file train.csv is imported into pulse train list train_imp.
PULM:TRA:DEXC:EXEC
starts the import of the ASCII file data into the pulse train file.
- Usage:** Event
- Options:** R&S SMA-K27 (Pulse Train)
- Manual control:** See "[Import / Export - Import/Export Pulse Train Files](#)" on page 310

[:SOURce<hw>]:PULM:TRAI:n:DEXChange:MODE <Mode>

The command selects if pulse train lists should be imported or exported. Depending on the selection, the file select command define either the source or the destination for pulse train lists and ASCII files.

Parameters:

<Mode> IMPort | EXPort
 *RST: IMPort

Example:

```
PULM:TRA:DEXC:MODE IMP
selects that ASCII files with ontime/offtime/repetition values are
imported and transferred into pulse train lists.
MME:CDIR 'var/lists/pulsetrain/import'
selects the directory for the ASCII files with ontime/offtime/repeti-
tion values.
PULM:TRA:DEXC:AFIL:SEL 'train.csv'
selects that ASCII file train.csv is imported.
PULM:TRA:DEXC:SEL 'train_imp'
selects that the ASCII file train.csv is imported into pulse train
list train_imp.
```

Options: R&S SMA-K27 (Pulse Train)

Manual control: See "[Mode – Import/Export Pulse Train Files](#)" on page 310

[:SOURce<hw>]:PULM:TRAI:n:DEXChange:SElect <Filename>

The command selects the pulse train list to be imported or exported.

The pulse train files are stored with the fixed file extensions *.pulstrn in a directory of the user's choice. The directory applicable to the commands is defined with the command MME:CDIR.

Parameters:

<Filename> string

Example:

```
PULM:TRA:DEXC:MODE IMP
selects that ASCII files with ontime/offtime/repetition values are
imported and transferred into pulse train lists.
MME:CDIR 'var/lists/pulsetrain/import'
selects the directory for the ASCII files with ontime/offtime/repeti-
tion values.
PULM:TRA:DEXC:AFIL:SEL 'train.csv'
selects that ASCII file train.csv is imported.
PULM:TRA:DEXC:SEL 'train_imp'
selects that the ASCII file train.csv is imported into pulse train
list train_imp.
```

Options: R&S SMA-K27 (Pulse Train)

Manual control: See "[Select Destination / Source - Import/Export Pulse Train Files](#)" on page 310

[:SOURce<hw>]:PULM:WIDTh <Width>

The command sets the width of the generated pulse. The width determines the pulse length. The pulse width must be at least 20ns less than the set pulse period.

Parameters:

<Width> float
 Range: 2 us | 5 ns to 100 s
 Increment: 1us | 5 ns
 *RST: 2 us
 Default unit: us

Example:

PULM:WIDT 33 us
 sets a width of 33 us for the pulse.

Options:

The enhanced features require option R&S SMA-K23 (Pulse Generator)

Manual control:

See "Pulse Width - Pulse Generator" on page 303

7.13.20 SOURce:ROSCillator Subsystem

This subsystem contains the commands for setting the external and internal reference frequency.



The commands of this subsystem are not affected by an instrument reset (*RST on page 357).

[:SOURce]:ROSCillator:EXTernal:FREQUency	592
[:SOURce]:ROSCillator:EXTernal:RFOF[:STATe]	592
[:SOURce]:ROSCillator:EXTernal:SBANdwidth	593
[:SOURce]:ROSCillator[:INTernal]:ADJust:VALue	594
[:SOURce]:ROSCillator[:INTernal]:ADJust[:STATe]	594
[:SOURce]:ROSCillator:SOURce	594

[:SOURce]:ROSCillator:EXTernal:FREQUency <Frequency>

Selects / indicates the external reference frequency.

Parameters:

<Frequency> 5MHz | 10MHz | 13MHz
 *RST: 10 MHz

Example:

ROSC:SOUR EXT
 selects the external source. The reference must be input at the REF IN input.
 ROSC:EXT:FREQ 5MHz
 selects 5 MHz external reference frequency.

Manual control:

See "External Reference Frequency" on page 125

[:SOURce]:ROSCillator:EXTernal:RFOF[:STATe] <State>

Activates that RF output is automatically switched off, when in external source mode no reference signal is supplied.

This setting ensures that no improper RF signal due to the missing external reference signal is output and used for measurements.

In addition to the error message "Ext Ref missing", the instrument generates the message "RF output deactivated".

Parameters:

<State> 0 | 1 | OFF | ON
*RST: 0

Example:

ROSC:SOUR EXT
selects the external source. The reference must be input at the REF IN input.

Example:

ROSC:EXT:RFOF:STAT ON
In case of a missing external signal, no RF signal is output.

Manual control:

See ["Deactivate RF Output - Reference Oscillator"](#) on page 125

[:SOURce]:ROSCillator:EXTernal:SBANDwidth <SBandwidth>

The command selects the synchronization bandwidth for an external reference signal.

Parameters:

<SBandwidth> WIDE | NARRow

NARRow

without R&S SMA-B22: Synchronization bandwidth is approx. 20 Hz.

with R&S SMA-B22: Synchronization bandwidth is a few Hz. The internal 10-MHz OCXO is synchronized to the external signal. This setting is recommended if the phase noise of the external signal is worse than the phase noise of the internal OCXO.

WIDE

without R&S SMA-B22: Synchronization bandwidth is approx. 750 Hz.

This mode is the standard mode, it is provided for using good reference sources of high spectral purity.

with R&S SMA-B22: This mode is recommended for good reference sources of high spectral purity. The internal 10-MHz OCXO is bypassed and the external signal synchronizes a 100-MHz reference oscillator directly. Synchronization bandwidth is app. 100 Hz.

Example:

ROSC:SOUR EXT
selects the external source.
ROSC:EXT:FREQ 5 MHz
informs the instrument that the external reference has a frequency of 5 MHz.
ROSC:EXT:SBAN WID
selects wideband setting for synchronization bandwidth.

Manual control:

See ["Synchronization Bandwidth - RF Signal"](#) on page 125

[[:SOURce]:ROSCillator[:INTernal]:ADJust:VALue <Value>

The command specifies the frequency correction value (adjustment value).

Parameters:

<Value> float
 Range: 0 to 4095
 Increment: 1

Example: ROSC:ADJ:VAL 1400
 sets the adjustment value to 1400.

Manual control: See "[Adjustment DAC Value](#)" on page 126

[[:SOURce]:ROSCillator[:INTernal]:ADJust[:STATe] <State>

The command determines whether the calibrated (OFF) or a user-defined (ON) adjustment value is used for fine adjustment of the frequency. With STATe ON, the instrument is no longer in the calibrated state. However, the calibration value is not changed and the instrument resumes the calibrated state after switching the Adjustment State to Off.

Parameters:

<State> 0 | 1 | OFF | ON
 *RST: 0

Example: ROSC:SOUR INT
 selects the internal source.
 ROSC:ADJ ON
 activates use of a user-defined adjustment value.
 ROSC:ADJ:VAL 1400
 sets the adjustment value to 1400.

Manual control: See "[Adjustment Active - Reference Oscillator](#)" on page 126

[[:SOURce]:ROSCillator:SOURce <Source>

Selects the reference frequency source.

Parameters:

<Source> INTernal | EXTernal

INTernal

The internal reference oscillator is used.

EXTernal

An external reference signal is used. It must be input at the REF IN connector at the rear of the instrument.

The instrument is informed of the frequency of the external reference signal by means of the command [[:SOURce]:

ROSCillator:EXTernal:FREQuency.

*RST: INTernal

- Example:** `ROSC:SOUR EXT`
 selects the external source.
 `ROSC:EXT:FREQ 5 MHz`
 informs the instrument that the external reference has a frequency
 of 5 MHz.
- Manual control:** See "Source - Reference Oscillator" on page 125

7.13.21 SOURce:SWEep Subsystem

This subsystem contains the commands for checking the RF sweeps, i.e. the sweeps of the RF generators. Sweeps are always triggered, except for the `MANual` sweep mode. The frequency sweep is activated by the command `SOURce:FREQuency:MODE SWEep`, and the level sweep by the command `SOURce:POWer:MODE SWEep`. All sweeps, including the LF sweep, can be set independently of each other.

This example shows how to set up a frequency sweep.

1. Set the sweep range.
`[SOURce:]FREQuency:CENTer 200 MHz`
`[SOURce:]FREQuency:SPAN 300 MHz`
2. Select linear or logarithmic spacing.
`[SOURce:]SWEep[:FREQuency]:SPACing LIN`
3. Set the step width and dwell time.
`[SOURce:]SWEep[:FREQuency]:STEP:LINear 20 MHz`
`[SOURce:]SWEep[:FREQuency]:DWELl 12 ms`
4. Select the trigger mode.
`TRIGger:]FSweep:SOURce SINGLE`
5. Select the sweep mode and activate the sweep.
`[SOURce:]SWEep[:FREQuency]:MODE AUTO`
`[SOURce:]FREQuency:MODE SWEep`
6. Trigger the sweep.
`[SOURce:]SWEep[:FREQuency]:EXECute`



It is recommended to switch off the "GUI Update" for optimum sweep performance especially with short dwell times (`SYSTem:DISPlay:UPDate OFF`).

<code>[SOURce<hw>]:SWEep[:FREQuency]:DWELl</code>	596
<code>[SOURce<hw>]:SWEep[:FREQuency]:EXECute</code>	596
<code>[SOURce<hw>]:SWEep[:FREQuency]:MODE</code>	597
<code>[SOURce<hw>]:SWEep[:FREQuency]:POINTs</code>	597
<code>[SOURce<hw>]:SWEep[:FREQuency]:SHAPE</code>	598
<code>[SOURce<hw>]:SWEep[:FREQuency]:SPACing</code>	598
<code>[SOURce<hw>]:SWEep[:FREQuency]:STEP:LINear</code>	599
<code>[SOURce<hw>]:SWEep[:FREQuency]:STEP:LOGarithmic</code>	600

<code>[:SOURce<hw>]:SWEep:POWer:AMODE</code>	600
<code>[:SOURce<hw>]:SWEep:POWer:DWELI</code>	601
<code>[:SOURce<hw>]:SWEep:POWer:EXECute</code>	601
<code>[:SOURce<hw>]:SWEep:POWer:MODE</code>	601
<code>[:SOURce<hw>]:SWEep:POWer:POINts</code>	602
<code>[:SOURce<hw>]:SWEep:POWer:SHAPE</code>	602
<code>[:SOURce<hw>]:SWEep:POWer:SPACing:MODE?</code>	603
<code>[:SOURce<hw>]:SWEep:POWer:STEP[:LOGarithmic]</code>	603
<code>[:SOURce<hw>]:SWEep:RESet[:ALL]</code>	604

`[:SOURce<hw>]:SWEep[:FREQuency]:DWELI <Dwell>`

The command sets the time taken for each frequency step of the sweep.

The keyword `[:FREQuency]` can be omitted (see example). The command is then SCPI-compliant.

Tip: It is recommended to switch off the "GUI Update" for optimum sweep performance especially with short dwell times (`SYSTem:DISPlay:UPDate OFF`).

Parameters:

<code><Dwell></code>	float
	Range: 3 ms to 100 s
	Increment: 100 us
	*RST: 10 ms
	Default unit: ms
<code><Dwell></code>	float
	Range: 2 ms to 100 s
	Increment: 100 us
	*RST: 15 ms
	Default unit: ms

Example: `SWE:DWEL 12 ms`
sets a dwell time of 12 ms for a frequency sweep at the RF output.

Manual control: See "[Dwell Time - Frequency Sweep](#)" on page 196

`[:SOURce<hw>]:SWEep[:FREQuency]:EXECute`

The command triggers a sweep.

The command is only valid for sweep mode Single (`SOURce:SWEep:FREQuency:MODE SINGLE`). The command corresponds to the manual-control command "Execute Single Sweep".

Example: `SWE:FREQ:MODE SING`
sets the single cycle mode of the frequency sweep
`SWE:FREQ:EXEC`
triggers a frequency sweep at the RF output.

Usage: Event

Manual control: See "[Execute Single Sweep - Frequency Sweep](#)" on page 193

[:SOURce<hw>]:SWEep[:FREQuency]:MODE <Mode>

Sets the sweep mode.

The keyword [:FREQuency] can be omitted (see example). The command is then SCPI-compliant.

Parameters:

<Mode>

AUTO | MANual | STEP

AUTO

Each trigger triggers exactly one complete sweep.

MANual

The trigger system is not active. Each frequency step of the sweep is triggered individually, either by varying the "Current Frequency" value using the rotary knob under manual control or by means of a `FREQ:MAN` command under remote control. With manual control, the frequency increases or decreases (depending on the direction of the rotary encoder) by the value specified under `FREQ:STEP:INCRement`. With remote control, the frequency is set directly with the command `:FREQ:MAN`.

STEP

Each trigger triggers one sweep step only (Mode Single Step). The frequency increases by the value entered under `SOUR:SWE:FREQ:STEP:LIN` (linear spacing) or `...:STEP:LOG` (logarithmic spacing).

*RST: AUTO

Example:

`SWE:MODE AUTO`

selects **Mode Auto** for a frequency sweep at the RF output.

Manual control:

See "[Mode - Frequency Sweep](#)" on page 191

[:SOURce<hw>]:SWEep[:FREQuency]:POINTs <Points>

The command sets the number of steps in an RF sweep.

The command is linked to the command `:SWEep[:FREQuency]:STEP` as follows:

- for linear sweeps
 $POINTs = (SPAN / STEP:LIN) + 1$
- logarithmic sweeps and `START < STOP`:
 $POINTs = ((\log STOP - \log START) / \log STEP:LOG) + 1$

If `POINTs` changes, the value of `STEP` is adjusted. The `START` and `STOP` value is retained.

Two separate `POINTs` values are used for linear or logarithmic sweep spacing (`:SWEep[:FREQuency]:SPACing LIN | LOG`). The command is always effective for the currently set sweep spacing.

Parameters:

<Points>

float

Example:

```
FREQ:STAR
sets the start frequency to 100 MHz.
FREQ:STOP
sets the stop frequency to 500 MHz.
SWE:SPAC LIN
sets linear sweep spacing.
SWE:POIN 401
sets 401 sweep steps for linear sweep spacing. The sweep step
width (STEP) is automatically set to 1 MHz.
```

[:SOURce<hw>]:SWEep[:FREQUENCY]:SHAPE <Shape>

The command sets the cycle mode for a sweep sequence (shape).

Parameters:

<Shape> SAWTooth | TRiangle

SAWTooth

One sweep runs from start to stop frequency. Each subsequent sweep starts at the start frequency, i.e. the shape of the sweep sequence resembles a sawtooth.

TRiangle

One sweep runs from start to stop frequency and back, i.e. the shape of the sweep resembles a triangle. Each subsequent sweep starts at the start frequency.

*RST: SAWTooth

Example:

```
SOUR:SWE:SHAP TRI
selects the sweep cycle with alternating ascending and descend-
ing sweep directions.
```

Manual control: See ["Shape - RF Frequency Sweep"](#) on page 194

[:SOURce<hw>]:SWEep[:FREQUENCY]:SPACing <Spacing>

The command selects the sweep spacing.

The keyword [:FREQUENCY] can be omitted (see example). The command is then SCPI-compliant.

Parameters:

<Spacing>

LINear | LOGarithmic

LINear

With the linear sweep, the step width is a fixed frequency value which is added to the current frequency. The step width for linear sweep is entered in Hz (see [:SOURce<hw>]:SWEep[:FREQuency]:STEP[:LINear] on page 599).

LOGarithmic

With the logarithmic sweep, the step width is a constant fraction of the current frequency. This fraction is added to the current frequency. The logarithmic step width is entered in % (see [:SOURce<hw>]:SWEep[:FREQuency]:STEP:LOGarithmic on page 600).

*RST: LIN

Example:

SWE:SPAC LIN

selects linear sweep spacing for a frequency sweep at the RF output.

Manual control:

See "Spacing - Frequency Sweep" on page 194

[:SOURce<hw>]:SWEep[:FREQuency]:STEP[:LINear] <Linear>

The command sets the step width for linear sweeps.

This command is linked to the command :SWEep[:FREQuency]:POINTs as follows:

$$\text{POINTs} = (\text{SPAN} / \text{STEP:LIN}) + 1$$

If STEP:LIN changes, the value of POINTs is adjusted. The START and STOP value is retained.

The keywords [:FREQuency] and [:LINear] can be omitted (see example). The command is then SCPI-compliant.

Parameters:

<Linear>

float

Range: 0.001 Hz to (STOP - START)

Increment: 0.001 Hz

*RST: 1 MHz

Default unit: MHz

Example:

FREQ:STAR 1GHz

sets the start frequency to 1 GHz.

FREQ:STOP 5GHz

sets the stop frequency to 5 GHz.

SWE:SPAC LIN

sets linear sweep spacing.

SWE:STEP 2 MHz

sets the step width for linear sweep spacing to 2 MHz (RF sweep) at the RF output. The number of sweep steps for linear sweep spacing (POINTs) is automatically set to 2001.

Manual control: See ["Step Lin/Log - Frequency Sweep"](#) on page 195

[:SOURce<hw>]:SWEep[:FREQuency]:STEP:LOGarithmic <Logarithmic>

The command specifies the step width factor for logarithmic sweeps. The next frequency value of a sweep is calculated (for `START < STOP`) using the following formula:

New frequency = Old frequency + `STEP:LOG` x Old frequency

`STEP:LOG` therefore gives the fraction of the old frequency. The frequency is increased by this fraction for the next sweep step. Usually `STEP:LOG` is given in percent, whereby the suffix `PCT` must always be used.

The command is linked to the command `:SWEep[:FREQuency]:POINTs` for `START < STOP` as follows:

$$\text{POINTs} = ((\log \text{STOP} - \log \text{START}) / \log \text{STEP:LOG}) + 1$$

If `STEP:LOG` changes, the value of `POINTs` is adjusted. The `START` and `STOP` value is retained.

Parameters:

<Logarithmic> float
 Range: 0.01 to 9999
 Increment: 0.01 PCT
 *RST: 1 PCT

Example:

```
FREQ:STAR 1GHz
sets the start frequency to 1 GHz.
FREQ:STOP 5GHz
sets the stop frequency to 5 GHz.
SWE:SPAC LOG
sets logarithmic sweep spacing.
SWE:STEP:LOG 10PCT
sets the step width for logarithmic sweep spacing to 10% of the
previous frequency in each instance (for a frequency sweep).
```

Manual control: See ["Step Lin/Log - Frequency Sweep"](#) on page 195

[:SOURce<hw>]:SWEep:POWer:AMODe <Amode>

The command selects the ranges of level settings for the level sweep. The sweep is either performed in the low level or in the high level ranges.

Parameters:

<Amode> NORMal | HPOWer

NORMal

The level settings are made in the range of the electronically switching attenuator. The high level ranges are not available.

HPOWer

The level settings are made in the high level range.

*RST: NORMal

Example: `SWE:POW:AMOD HPOW`
selects the high level ranges for level sweep.

Manual control: See ["Attenuator Mode - Level Sweep with High Power Option"](#) on page 202

[[:SOURce<hw>]:SWEep:POWer:DWELI <Dwell>

The command sets the time taken for each level step of the sweep.

Tip: It is recommended to switch off the "GUI Update" for optimum sweep performance especially with short dwell times (`SYSTem:DISPlay:UPDate OFF`).

Parameters:

<Dwell> float
Range: 1.0E-3 to 100
Increment: 100.0E-6
*RST: 15.0E-3
Default unit: s

Example: `SWE:POW:DWEL 12 ms`
sets a dwell time of 12 ms for a level sweep at the RF output.

Manual control: See ["Dwell Time - Level Sweep"](#) on page 201

[[:SOURce<hw>]:SWEep:POWer:EXECute

The command triggers a sweep.

The command is only valid for sweep mode Single (`SOURce:SWEep:POWer:MODE SINGLE`). The command corresponds to the manual-control command "Execute Single Sweep".

Example: `SOURce:SWEep:POWer:MODE SINGLE`
sets the single cycle mode of the level sweep.
`SWE:POW:EXEC`
triggers a level sweep at the RF output.

Usage: Event

Manual control: See ["Execute Single Sweep - Level Sweep"](#) on page 200

[[:SOURce<hw>]:SWEep:POWer:MODE <Mode>

The command sets the cycle mode of the level sweep.

Parameters:

<Mode>

AUTO | MANual | STEP

AUTO

Each trigger triggers exactly one complete sweep.

MANual

The trigger system is not active. Each level step of the sweep is triggered individually, either by varying the "Current Level" value using the rotary knob under manual control or by means of a POW:MAN command under remote control.

With manual control, the level increases or decreases (depending on the direction of the rotary encoder) by the value specified under SOUR:SWE:POW:STEP. With remote control, the level increases by the value specified under SWEep:POW:STEP which each sent :POW:MAN command, irrespective the value entered there.

STEP

Each trigger triggers one sweep step only. The level increases by the value entered under :SWEep:POW:STEP.

*RST: AUTO

Example:

SWE:POW:MODE AUTO

selects Mode Auto for a level sweep at RF output.

Manual control:See "[Mode - Level Sweep](#)" on page 197**[:SOURce<hw>]:SWEep:POW:POINts <Points>**

The command sets the number of steps in a level sweep. The command is linked to the command :SWEep:POW:STEP as follows:

$$\text{POINTs} = ((\text{STOP} - \text{START}) / \text{STEP:LOG}) + 1$$

If POINTs changes, the value of STEP is adjusted. The START and STOP value is retained.

Parameters:

<Points>

float

*RST: 20dB

Example:

POW:STAR - 30 dBm

sets the start frequency to -30 dBm.

POW:STOP - 10 dBm

sets the stop frequency to -10 dBm.

SWE:POW:POIN 20

sets 20 sweep steps. The sweep step width (STEP) is automatically set to 1 dB.

[:SOURce<hw>]:SWEep:POW:SHAPE <Shape>

The command sets the cycle mode for a sweep sequence (shape).

Parameters:

<Shape> SAWTooth | TRiangle

SAWTooth

One sweep runs from the start level to the stop level. The subsequent sweep starts at the start level again, i.e. the shape of sweep sequence resembles a sawtooth.

TRiangle

One sweep runs from start to stop level and back, i.e. the shape of the sweep resembles a triangle. Each subsequent sweep starts at the start level again.

*RST: SAWTooth

Example:

SOUR:SWE:POW:SHAP TRI

selects the sweep cycle with alternating ascending and descending sweep directions.

Manual control:See "[Shape - RF Level Sweep](#)" on page 201**[:SOURce<hw>]:SWEep:POWer:SPACing:MODE?**

The command queries the sweep spacing. The sweep spacing for level sweeps is always linear.

Example:

SWE:POW:SPAC:MODE?

queries the sweep spacing for a level sweep at RF output.

Result: LIN

linear spacing

Usage:

Query only

[:SOURce<hw>]:SWEep:POWer:STEP[:LOGarithmic] <Logarithmic>

The command sets the step width factor for logarithmic sweeps. The next level value of a sweep is calculated (for `START < STOP`) using the following formula:

$$\text{New level} = \text{Old level} + \text{STEP:LOG} \times \text{Old level}$$

`STEP:LOG` therefore gives the fraction of the old level. The level is increased by this fraction for the next sweep step. Usually `STEP:LOG` is given in decibels, whereby the suffix dB must always be used.

The command is linked to the command `:SWEep:POWer:POINts` for `START < STOP` as follows:

$$\text{POINts} = ((\text{STOP} - \text{START}) / \text{STEP:LOG}) + 1$$

If `STEP:LOG` changes, the value of `POINts` is adjusted. The `START` and `STOP` value is retained.

Parameters:

<Logarithmic> float
 Range: 0.01 to 139 dB
 Increment: 0.01 dB
 *RST: 1

Example:

SWE:POW:STEP 10dB
 sets the step width for logarithmic sweep spacing to 10 dB of the previous level in each instance (for a level sweep).

Manual control:

See ["Step - Level Sweep"](#) on page 201

[[:SOURce<hw>]:SWEep:RESet[:ALL]]

The command resets all active sweeps to the starting point.

Example:

SWE:RES
 resets all active sweeps to the starting point.

Manual control:

See ["Reset Sweep - Frequency Sweep"](#) on page 194

7.13.22 SOURce:VOR Subsystem

The VOR subsystem contains the commands for checking the VOR modulation. The AM-specific characteristics of the internal modulation source are defined with commands SOURce:VOR: . . . Characteristics which are valid for all modulations and the LF Output are configured in the SOURce:LFOutput subsystem. The external signal is input at the AM EXT connector.

[[:SOURce]:VOR:COMid:CODE.....	605
[[:SOURce]:VOR:COMid:DASH.....	605
[[:SOURce]:VOR:COMid:DEPTh.....	606
[[:SOURce]:VOR:COMid:DOT.....	606
[[:SOURce]:VOR:COMid:FREQuency.....	606
[[:SOURce]:VOR:COMid:LETTer.....	607
[[:SOURce]:VOR:COMid:PERiod.....	607
[[:SOURce]:VOR:COMid:SYMBol.....	608
[[:SOURce]:VOR:COMid:TSCHEMA.....	608
[[:SOURce]:VOR:COMid[:STATe].....	609
[[:SOURce]:VOR:FREQuency:STEP.....	609
[[:SOURce]:VOR:ICAO:CHANnel.....	609
[[:SOURce]:VOR:MODE.....	610
[[:SOURce]:VOR:PRESet.....	611
[[:SOURce]:VOR:REFerence[:DEViation].....	611
[[:SOURce]:VOR:SOURce.....	612
[[:SOURce]:VOR:STATe.....	612
[[:SOURce]:VOR:SUBCarrier:DEPTh.....	613
[[:SOURce]:VOR:SUBCarrier[:FREQuency].....	613
[[:SOURce]:VOR:VAR:FREQuency.....	613

[:SOURce]:VOR:VAR[:DEPTH]	614
[:SOURce]:VOR[:BANGLE]	614
[:SOURce]:VOR[:BANGLE]:DIRection	614

[:SOURce]:VOR:COMid:CODE <Code>

Enters the coding of the COM/ID signal by the international short name of the airport (e.g. MUC for the Munich airport). (COM/ID signal). The COM/ID tone is sent according to the selected code (see [table 5-8](#)). If no coding is entered, the COM/ID tone is sent uncoded (key down).

The length of the morse code can be varied. For selection standard time scheme (VOR:COM:TSCH STD), the selected dot length determines the setting of all other length parameters of the morse code (dash length, symbol space and letter space) . For selection user time scheme (VOR:COM:TSCH USER), all length parameters of the code can be set independently.

Parameters:

<Code> string

Example: VOR:COM:CODE 'MUC '
select COM/ID code for Munich airport.

Usage: SCPI confirmed

Options: Option R&S SMA-K25

Manual control: See "[COM/ID Code - VOR Modulation](#)" on page 262

[:SOURce]:VOR:COMid:DASH <Dash>

Enters the length of a morse dash by means of seconds. This command is available for user time schema only.

Parameters:

<Dash> float
Range: 50 ms to 1s
Increment: 0.1 ms
*RST: 300 ms
Default unit: ms

Example: VOR:COM:CODE 'MUC '
selects code for Munich airport
VOR:COM:TSCH USER
selects user time schema
VOR:COM:DOT 200ms
sets a dot length of 200 ms.
VOR:COM:DASH 400ms
sets a dash length of 400 ms.
VOR:COM:LETT 50ms
sets a letter space of 50 ms.
VOR:COM:SYMB 10ms
sets a symbol space of 10 ms.

- Options:** Option R&S SMA-K25
- Manual control:** See "[COM/ID Dash Length - VOR Modulation](#)" on page 264

[[:SOURce]:VOR:COMid:DEPTH <Depth>

The command enters the AM modulation depth of the additional communication/identification signal.

Parameters:

<Depth> float
 Range: 0 to 100
 Increment: 0.1
 *RST: 5
 Default unit: PCT

Example: `VOR:COM:FREQ 1020`
 sets the frequency of the communication/identification signal to the standard value of 1020Hz

Usage: SCPI confirmed

Options: Option R&S SMA-K25

Manual control: See "[COM/ID Depth - VOR Modulation](#)" on page 263

[[:SOURce]:VOR:COMid:DOT <Dot>

Enters the length of a morse dot by means of seconds. The length of the dash (3xdot), symbol space (=dot) and letter space (=3xdot) is also determined by this entry.

Parameters:

<Dot> float
 Range: 50 ms to 1 s
 Increment: 0.1 ms
 *RST: 100 ms
 Default unit: ms

Example: `VOR:COM:CODE 'MUC'`
 selects code for Munich airport
`VOR:COM:DOT 200ms`
 sets a dot length of 200 ms.

Options: Option R&S SMA-K25

Manual control: See "[COM/ID Dot Length - VOR Modulation](#)" on page 264

[[:SOURce]:VOR:COMid:FREQuency <Frequency>

The command sets the frequency of the communication/identification signal.

Parameters:

<Frequency> float
 Range: 0.1 to 20000
 Increment: 0.1
 *RST: 1020
 Default unit: Hz

Example:

VOR:COM:FREQ 1020
 sets the frequency of the communication/identification signal to the standard value of 1020Hz.

Usage: SCPI confirmed

Options: Option R&S SMA-K25

Manual control: See "[COM/ID Frequency - VOR Modulation](#)" on page 263

[:SOURce]:VOR:COMid:LETTer <Letter>

Enters the length of a letter space by means of seconds. This command is available user time schema only.

Parameters:

<Letter> float
 Range: 50 ms to 1 s
 Increment: 0.1 ms
 *RST: 300 ms
 Default unit: ms

Example:

VOR:COM:CODE 'MUC'
 selects code for Munich airport
 VOR:COM:TSCH USER
 selects user time schema
 VOR:COM:DOT 200ms
 sets a dot length of 200 ms.
 VOR:COM:DASH 400ms
 sets a dash length of 400 ms.
 VOR:COM:LETT 50ms
 sets a letter space of 50 ms.
 VOR:COM:SYMB 10ms
 sets a symbol space of 10 ms.

Options: Option R&S SMA-K25

Manual control: See "[COM/ID Letter Space - VOR Modulation](#)" on page 264

[:SOURce]:VOR:COMid:PERiod <Period>

Enters the period of the COM/ID signal in seconds.

Parameters:

<Period> float
 Range: 0 ms to 120 s
 Increment: 1 ms
 *RST: 9 s

Example:

VOR:COM:PER 33s
 sets a period of 33 s for the COM/ID signal.

Options:

Option R&S SMA-K25

Manual control:

See "[COM/ID Period - VOR Modulation](#)" on page 263

[[:SOURce]:VOR:COMid:SYMBOL <Symbol>

Enters the length of the symbol space by means of seconds. This command is available for user time schema only.

Parameters:

<Symbol> float
 Range: 50 ms to 1 s
 Increment: 0.1 ms
 *RST: 100
 Default unit: ms

Example:

VOR:COM:CODE 'MUC'
 selects code for Munich airport
 VOR:COM:TSCH USER
 selects user time schema
 VOR:COM:DOT 200ms
 sets a dot length of 200 ms.
 VOR:COM:DASH 400ms
 sets a dash length of 400 ms.
 VOR:COM:LETT 50ms
 sets a letter space of 50 ms.
 VOR:COM:SYMB 10ms
 sets a symbol space of 10 ms.

Options:

Option R&S SMA-K25

Manual control:

See "[COM/ID Symbol Space - VOR Modulation](#)" on page 264

[[:SOURce]:VOR:COMid:TSCHema <Tschema>

Selects if the set dot length determines the dash length (= three times the dot length) (setting STD) or if all length parameters can be set independently (setting USER). (COM/ID signal).

Parameters:

<Tschema> STD | USER
 *RST: STD

- Example:** VOR:COM:CODE 'MUC'
 selects code for Munich airport
 VOR:COM:TSCH STD
 selects standard time schema
 VOR:COM:DOT 200ms
 sets a dot length of 200 ms. The dash length and letter space is 3
 x dot length, the symbol space equals the dot length.
- Options:** Option R&S SMA-K25
- Manual control:** See "[COM/ID Time Schema - VOR Modulation](#)" on page 263

[[:SOURce]:VOR:COMid[:STATe] <State>

The command switches on or off the additional communication/identification signal.

Parameters:

<State> 0 | 1 | OFF | ON
 *RST: OFF

Example: MBE:COM ON
 activates the COM/ID signal.

Usage: SCPI confirmed

Options: Option R&S SMA-K25

Manual control: See "[COM/ID State - VOR Modulation](#)" on page 262

[[:SOURce]:VOR:FREQuency:STEP <Step>

Selects the variation of the carrier frequency via the rotary knob.

Parameters:

<Step> DECimal | ICAO
 DECimal
 Decimal variation according to the current cursor position.
 ICAO
 Variation in predefined steps according to the standardized VOR
 transmitting frequencies, see [table 5-9](#).
 *RST: DECimal

Example: VOR:FREQ:STEP DEC
 Varies the frequency in decimal steps.

Manual control: See "[Carrier Frequency Step - VOR Modulation](#)" on page 264

[[:SOURce]:VOR:ICAO:CHANnel <Channel>

The command selects the ICAO channel i.e., the VOR transmitting frequency. The RF-frequency is set to the value selected here.

Parameters:

<Channel> X17 | Y17 | X19 | Y19 | X21 | Y21 | X23 | Y23 | X25 | Y25 | X27 |
 Y27 | X29 | Y29 | X31 | Y31 | X33 | Y33 | X35 | Y35 | X37 | Y37 |
 X39 | Y39 | X41 | Y41 | X43 | Y43 | X45 | Y45 | X47 | Y47 | X49 |
 Y49 | X51 | Y51 | X53 | Y53 | X55 | Y55 | X57 | Y57 | X58 | Y58 |
 X59 | Y59 | X70 | Y70 | X71 | Y71 | X72 | Y72 | X73 | Y73 | X74 |
 Y74 | X75 | Y75 | X76 | Y76 | X77 | Y77 | X78 | Y78 | X79 | Y79 |
 X80 | Y80 | X81 | Y81 | X82 | Y82 | X83 | Y83 | X84 | Y84 | X85 |
 Y85 | X86 | Y86 | X87 | Y87 | X88 | Y88 | X89 | Y89 | X90 | Y90 |
 X91 | Y91 | X92 | Y92 | X93 | Y93 | X94 | Y94 | X95 | Y95 | X96 |
 Y96 | X97 | Y97 | X98 | Y98 | X99 | Y99 | X100 | Y100 | X101 |
 Y101 | X102 | Y102 | X103 | Y103 | X104 | Y104 | X105 | Y105 |
 X106 | Y106 | X107 | Y107 | X108 | Y108 | X109 | Y109 | X110 |
 Y110 | X111 | Y111 | X112 | Y112 | X113 | Y113 | X114 | Y114 |
 X115 | Y115 | X116 | Y116 | X117 | Y117 | X118 | Y118 | X119 |
 Y119 | X120 | Y120 | X121 | Y121 | X122 | Y122 | X123 | Y123 |
 X124 | Y124 | X125 | Y125 | X126 | Y126

*RST: X17

Example:

VOR:ICAO:CHAN X19
 selects ICAO frequency channel 19X. This channel sets the RF
 frequency to 108.2 MHz.

Options:

Option R&S SMA-K25

Manual control:

See "[ICAO Channel - VOR Modulation](#)" on page 264

[:SOURce]:VOR:MODE <Mode>

Selects the operating mode for the VOR modulation signal.

Parameters:

<Mode>

NORM | VAR | SUBCarrier | FMSubcarrier

NORM

VOR modulation is active.

VAR

Amplitude modulation of the output signal with the variable signal component (30Hz signal content) of the VOR signal. The modulation depth of the 30 Hz signal corresponds to the value set with command `SOURce:VOR:VAR:DEPTH`.

SUBCarrier

Amplitude modulation of the output signal with the unmodulated FM carrier (9960Hz) of the VOR signal. The modulation depth corresponds to the value set with command `SOURce:VOR:SUBCarrier:DEPTH`.

FMSubcarrier

Amplitude modulation of the output signal with the frequency-modulated FM carrier (9960Hz) of the VOR signal. The frequency deviation corresponds to the value set with command `SOURce:VOR:REFEreNce:DEVIation`, the modulation depth corresponds to the value set with command `SOURce:VOR:SUBCarrier:DEPTH`.

*RST: NORM

Example:

VOR:MODE VAR

Activates amplitude modulation of the output signal with the upper lobe (90Hz) signal component of the VOR signal.

Usage:

SCPI confirmed

Options:

Option R&S SMA-K25

Manual control:See "[Mode - VOR Modulation](#)" on page 259**[[:SOURce]:VOR:PRESet**

The commands activate the VOR default settings.

Example:

VOR:PRESet

activates the VOR default settings for all `SOURce:VOR:... commands`.

Usage:

SCPI confirmed

Options:

Option R&S SMA-K25

Manual control:See "[Set to Default - VOR Modulation](#)" on page 261**[[:SOURce]:VOR:REFEreNce[:DEVIation] <Deviation>**

The command sets the frequency deviation of the reference signal on the FM carrier.

Parameters:

<Deviation> float
 Range: 0 to 960
 Increment: 1
 *RST: 480
 Default unit: Hz

Example:

VOR:REF 480
 sets the frequency deviation of the reference signal on the FM carrier to 480 Hz.

Usage: SCPI confirmed

Options: Option R&S SMA-K25

Manual control: See "[REF Deviation - VOR Modulation](#)" on page 261

[[:SOURce]:VOR:SOURce <Source>

The command selects the modulation source for VOR modulation. `INT` is the internal modulation source. The external signal is input at the AM EXT connector. The external signal is added to the internal signal. Switching off the internal source is not possible.

Parameters:

<Source> INT | INT,EXT | EXT
 *RST: INTERNAL

Example:

VOR:SOUR INT
 selects the internal modulation source.

Usage: SCPI confirmed

Options: Option R&S SMA-K25

Manual control: See "[EXT AM - VOR Modulation](#)" on page 265

[[:SOURce]:VOR:STATe <State>

The commands activate/deactivate VOR modulation.

Parameters:

<State> 0 | 1 | OFF | ON
 *RST: OFF

Example:

MBE:COM ON
 activates the COM/ID signal.

Usage: SCPI confirmed

Options: Option R&S SMA-K25

Manual control: See "[State - VOR Modulation](#)" on page 259

[[:SOURce]:VOR:SUBCarrier:DEPTH <Depth>

Enters the AM modulation depth of the FM carrier.

Parameters:

<Depth> float
 Range: 0 to 100
 Increment: 0.1
 *RST: 30

Example: VOR:SUBC:DEPT 30PCT
 enters a modulation depth of 30 percent for the subcarrier.

Usage: SCPI confirmed

Options: Option R&S SMA-K25

Manual control: See "[Subcarrier Depth - VOR Modulation](#)" on page 261

[[:SOURce]:VOR:SUBCarrier[:FREQUENCY] <Frequency>

Enters the frequency of the FM carrier.

Parameters:

<Frequency> float
 Range: 5000 to 15000
 Increment: 10
 *RST: 9960
 Default unit: Hz

Example: VOR:SUBC 9960
 enters the standard frequency of 9960 Hz for the FM sub carrier.

Options: Option R&S SMA-K25

Manual control: See "[Subcarrier Frequency - VOR Modulation](#)" on page 261

[[:SOURce]:VOR:VAR:FREQUENCY <Frequency>

Enters the frequency of the variable and the reference signal. . As the two signals must have the same frequency, the setting is valid for both signals.

Parameters:

<Frequency> float
 Range: 20 to 60
 Increment: 0.1
 *RST: 30

Example: VOR:VAR:FREQ 30
 'enters a frequency of 30 Hz for the variable and reference signal.

Usage: SCPI confirmed

Options: Option R&S SMA-K25

Manual control: See "[VAR/REF Frequency - VOR Modulation](#)" on page 260

[[:SOURce]:VOR:VAR[:DEPTH] <Depth>

Enters the AM modulation depth of the 30Hz variable signal.

Parameters:

<Depth> float
 Range: 0 to 100
 Increment: 0.1
 *RST: 30
 Default unit: PCT

Example: VOR:VAR 30PCT
 enters a modulation depth of 30 percent for the variable signal.

Usage: SCPI confirmed

Options: Option R&S SMA-K25

Manual control: See "[VAR Depth - VOR Modulation](#)" on page 260

[[:SOURce]:VOR[:BANGLE] <Bangle>

The command sets the Bearing ANGLE between the VAR signal and the reference signal. The orientation of the angle depends on the setting under

SOURce:VOR:BANGLE:DIRection.

Parameters:

<Bangle> float
 Range: 0 to 360
 Increment: 0.01 deg
 *RST: 0 deg
 Default unit: deg

Example: VOR 20DEG
 sets a phase angle of 20 degrees between the variable signal and the reference signal

Options: Option R&S SMA-K25

Manual control: See "[Bearing Angle - VOR Modulation](#)" on page 260

[[:SOURce]:VOR[:BANGLE]:DIRection <Direction>

Enters the reference position of the phase information.

Parameters:

<Direction>

FROM | TO

FROM

The bearing angle is measured between the geographic north and the connection line from beacon to airplane.

TO

The bearing angle is measured between the geographic north and the connection line from airplane to beacon.

*RST: FROM

Example:

VOR:DIR FROM

selects the beacon as a reference position. The angle corresponds to the angle between the geographic north and the connection line from beacon to airplane.

Options:

Option R&S SMA-K25

Manual control:See "[Direction - VOR Modulation](#)" on page 260

7.14 STATus Subsystem

This system contains the commands for the status reporting system. *RST on page 357 has no effect on the status registers.

Queries return the current value of the respective register, which permits a check of the device status. A decimal value between 0 and 32767 ($=2^{15}-1$) is returned.

The configuration commands set the respective register thus determining which status changes of the R&S SMA causes the status registers to be changed. A decimal value between 0 and 32767 ($=2^{15}-1$) is set.

STATus:OPERation:CONDition?	615
STATus:OPERation:ENABLE	616
STATus:OPERation[:EVENTj]?	616
STATus:OPERation:NTRansition	616
STATus:OPERation:PTRansition	617
STATus:PRESet	617
STATus:QUESTionable:CONDition?	617
STATus:QUESTionable:ENABLE	618
STATus:QUESTionable[:EVENTj]?	618
STATus:QUESTionable:NTRansition	618
STATus:QUESTionable:PTRansition	618
STATus:QUEuef:NEXTj?	619

STATus:OPERation:CONDition? <Condition >

The command queries the content of the CONDition part of the STATus:OPERation register. This part contains information on the action currently being performed in the instrument. The content is not deleted after being read out since it indicates the current hardware status.

Parameters:**<Condition >** string**Example:**

```
STAT:OPER:COND
```

queries the Status:Operation:Condition register.

Usage:

Query only
SCPI confirmed

STATus:OPERation:ENABle <Enable>

The command sets the bits of the ENABle part of the STATus:OPERation register. This setting determines which events of the Status-Event part are forwarded to the sum bit in the status byte. These events can be used for a service request.

Parameters:**<Enable>** string**Example:**

```
STAT:OPER:ENAB 32767
```

all events are forwarded to the sum bit of the status byte.

Usage:

SCPI confirmed

STATus:OPERation[:EVENT]? <EVENT>

The command queries the content of the EVENT part of the STATus:OPERation register. This part contains information on the actions performed in the instrument since the last readout. The content of the EVENT part is deleted after being read out.

Parameters:**<EVENT>** string**Example:**

```
STAT:OPER:EVEN
```

queries the STATus:OPERation:EVENT register.

Usage:

Query only
SCPI confirmed

STATus:OPERation:NTRansition <Ntransition>

The command sets the bits of the NTRansition part of the STATus:OPERation register. If a bit is set, a transition from 1 to 0 in the condition part causes an entry to be made in the EVENT part of the register. The disappearance of an event in the hardware is thus registered, e.g. the end of an adjustment.

Parameters:**<Ntransition>** string**Example:**

```
STAT:OPER:NTR 0
```

a transition from 1 to 0 in the condition part of the Status:Operation register does not cause an entry to be made in the EVENT part.

Usage:

SCPI confirmed

STATus:OPERation:PTRansition <Ptransition>

The command sets the bits of the PTRansition part of the STATus:OPERation register. If a bit is set, a transition from 0 to 1 in the condition part causes an entry to be made in the EVENT part of the register. A new event in the hardware is thus registered, e.g. the start of an adjustment.

Parameters:

<Ptransition> string

Example:

STAT:OPER:PTR 32767

all transitions from 0 to 1 in the condition part of the Status:Operation register cause an entry to be made in the EVENT part.

Usage: SCPI confirmed

STATus:PRESet <Preset>

The command resets the status registers. All PTRansition parts are set to FFFFh (32767), i.e. all transitions from 0 to 1 are detected. All NTRansition parts are set to 0, i.e. a transition from 1 to 0 in a CONDition bit is not detected. The ENABLE parts of STATus:OPERation and STATus:QUEStionable are set to 0, i.e. all events in these registers are not passed on.

Parameters:

<Preset> string

Example:

STAT:PRES

resets the status registers.

Usage: Event
SCPI confirmed

STATus:QUEStionable:CONDition? <Condition >

The command queries the content of the CONDition part of the STATus:QUEStionable register. This part contains information on the action currently being performed in the instrument. The content is not deleted after being read out since it indicates the current hardware status.

Parameters:

<Condition > string

Example:

STAT:OPER:COND

queries the Status:Questionable:Condition register.

Usage: Query only
SCPI confirmed

STATus:QUESTIONable:ENABLE <Enable>

The command sets the bits of the ENABLE part of the STATus:QUESTIONable register. This setting determines which events of the Status-Event part are enabled for the sum bit in the status byte. These events can be used for a service request.

Parameters:

<Enable> string

Example:

STAT:OPER:ENAB 1

problems when performing an adjustment cause an entry to be made in the sum bit.

Usage:

SCPI confirmed

STATus:QUESTIONable[:EVENT]? <EVENT>

The command queries the content of the EVENT part of the STATus:QUESTIONable register. This part contains information on the actions performed in the instrument since the last readout. The content of the EVENT part is deleted after being read out.

Parameters:

<EVENT> string

Example:

STAT:QUES:EVENT?

queries the Status:Questionable:Event register.

Usage:

Query only
SCPI confirmed

STATus:QUESTIONable:NTRansition <Ntransition>

The command sets the bits of the NTRansition part of the STATus:QUESTIONable register. If a bit is set, a transition from 1 to 0 in the condition part causes an entry to be made in the EVENT part of the register.

Parameters:

<Ntransition> string

Example:

STAT:OPER:NTR 0

A transition from 1 to 0 in the condition part of the Status:Questionable register does not cause an entry to be made in the EVENT part.

Usage:

SCPI confirmed

STATus:QUESTIONable:PTRansition <Ptransition>

The command sets the bits of the PTRansition part of the STATus:QUESTIONable register. If a bit is set, a transition from 1 to 0 in the condition part causes an entry to be made in the EVENT part of the register.

Parameters:

<Ptransition> string

Example:

STAT:OPER:PTR 32767

All transitions from 0 to 1 in the condition part of the Status:Questionable register cause an entry to be made in the EVENT part.

Usage:

SCPI confirmed

STATus:QUEue[:NEXT]?

The command queries the oldest entry in the error queue and then deletes it. Positive error numbers denote device-specific errors, and negative error numbers denote error messages defined by SCPI. If the error queue is empty, 0 ("No error") is returned. The command is identical to `SYSTEM:ERRor?`

Return values:

<NEXT> string

Example:

STAT:QUE

queries the oldest entry in the error queue.

Response: 0, 'no error'

No errors have occurred since the error queue was last read out.

Usage:

Query only
SCPI confirmed

Manual control: See "[History](#)" on page 60

7.15 SYSTEM Subsystem

The `SYSTEM` subsystem contains a series of commands for general functions which do not directly affect signal generation.

<code>:SYSTEM:BEEPer:STATe</code>	620
<code>:SYSTEM:COMMunicate:GPIB:LTERminator</code>	620
<code>:SYSTEM:COMMunicate:GPIB[:SELF]:ADDRess</code>	621
<code>:SYSTEM:COMMunicate:HISLip:RESourCe</code>	621
<code>:SYSTEM:COMMunicate:NETWork[:COMMOn]:DOMain</code>	621
<code>:SYSTEM:COMMunicate:NETWork[:COMMOn]:HOSTName</code>	622
<code>:SYSTEM:COMMunicate:NETWork[:COMMOn]:WORKgrouP</code>	622
<code>:SYSTEM:COMMunicate:NETWork:IPADdress:MODE</code>	622
<code>:SYSTEM:COMMunicate:NETWork:IPADdress</code>	623
<code>:SYSTEM:COMMunicate:NETWork:IPADdress:GATeway</code>	623
<code>:SYSTEM:COMMunicate:NETWork:IPADdress:SUBNet:MASK</code>	623
<code>:SYSTEM:COMMunicate:NETWork:RESourCe</code>	624
<code>:SYSTEM:COMMunicate:USB:RESourCe?</code>	624
<code>:SYSTEM:COMMunicate:GPIB:RESourCe?</code>	624
<code>:SYSTEM:COMMunicate:SERial:RESourCe?</code>	624
<code>:SYSTEM:COMMunicate:SERial:BAUD</code>	625
<code>:SYSTEM:COMMunicate:SERial:PARity</code>	625

:SYSTem:COMMunicate:SERial:SBITs.....	625
:SYSTem:COMMunicate:SOCKet:RESource?.....	625
:SYSTem:DATE.....	626
:SYSTem:DISPlay:UPDate.....	626
:SYSTem:DLOCK.....	626
SYSTem:ERRor:ALL?.....	627
SYSTem:ERRor:CODE:ALL?.....	627
SYSTem:ERRor:CODE[:NEXT]?.....	627
SYSTem:ERRor:COUNT?.....	628
SYSTem:ERRor[:NEXT]?.....	628
:SYSTem:IDENtification.....	629
:SYSTem:IRESpone.....	629
:SYSTem:KLOCK.....	629
:SYSTem:LANGuage.....	630
:SYSTem:ORESpone.....	630
:SYSTem:PROTect<ch>[:STATe].....	630
SYSTem:SERror?.....	631
:SYSTem:STARtup:COMPLete?.....	631
:SYSTem:TIME.....	632
SYSTem:VERsion?.....	632

:SYSTem:BEEPer:STATe <State>

This command switches the key beep on or off.

Parameters:

<State> 0 | 1 | OFF | ON
 *RST: OFF

Example:

SYST:BEEP:STAT OFF
 No acoustic signal is output when a key on the front panel is pressed.

Usage: SCPI confirmed

:SYSTem:COMMunicate:GPIB:LTERminator <Lterminator>

The command sets the terminator recognition for remote control via GPIB bus.

Parameters:

<Lterminator> STANdard | EOI

EOI

The terminator must be sent together with the line message EOI (End of Line). This setting is recommended for binary block transmissions where a character could coincidentally have the value LF (Line Feed) but is not intended as the terminator. This setting must be selected for block data with undefined length.

STANdard

An LF (Line Feed) is recognized as the terminator regardless of whether it is sent with or without EOI.

*RST: STANdard

Example:

```
SYST:COMM:GPIB:LTER EOI
```

only a character which is sent simultaneously with the line message EOI is accepted as the terminator.

:SYSTem:COMMunicate:GPIB[:SELF]:ADDRess <Address>

Sets the GPIB address.

Parameters:

<Address> integer
 Range: 1 to 30
 *RST: 28

Example:

```
SYST:COMM:GPIB:ADDR 14
```

sets GPIB address.

Manual control: See "[GPIB channel address](#)" on page 96

:SYSTem:COMMunicate:HISLip:RESource

Queries the VISA resource string . This string is used for remote control of the instrument with HiSLIP protocol.

Parameters:

<Resource> string

Example:

```
SYST:COMM:HISL:RES
```

queries the VISA resource string.

```
Response: TCPIP::192.1.2.3::hislip0::INSTR
```

Manual control: See "[Visa Resource Strings](#)" on page 97

:SYSTem:COMMunicate:NETWork[:COMMON]:DOMain <Domain>

The command enters the domain of the network.

Parameters:

<Domain> string

Example: `SYST:COMM:NETW:COMM:DOM ABC.DE`
enters the domain of the network.

:SYSTem:COMMunicate:NETWork[:COMMON]:HOSTname <Hostname>

The command enters the individual computer name of the R&S Signal Generator. The entry is only activated after sending command `SYST:COMM:NETW:COMM:SET`.

Note: The hostname can only be changed after deactivating protection level 1 (command `SYSTem:PROTeCt<n>:STATe OFF, password`)

Parameters:

<Hostname> string

Example: `SYST:COMM:NETW:HOST 'SIGGEN'`
enters the individual computer name of the R&S Signal Generator.

Example: `SYST:COMM:NETW:COMM:SET ON`
activates the change of the hostname.

Manual control: See "[Hostname](#)" on page 92

:SYSTem:COMMunicate:NETWork[:COMMON]:WORKgroup <Workgroup>

The command enters the individual workgroup name of the instrument.

Parameters:

<Workgroup> string

Example: `SYST:COMM:NETW:COMM:WORK 'TEST_09'`
enters the workgroup name 'TEST_09'.

Manual control: See "[Workgroup](#)" on page 92

:SYSTem:COMMunicate:NETWork:IPADdress:MODE <Mode>

The command selects if the IP address is assigned automatically or manually. The entry is only activated after sending command `SYST:COMM:NETW:IPAD:SET`.

Parameters:

<Mode> AUTO | STATic

AUTO

The IP address is assigned automatically. The network used must support automatic assignment of address (DHCP) in order to use this function.

STATic

The IP address is assigned manually.

*RST: AUTO

Example: `SYST:COMM:NETW:IPAD:MODE AUTO`
the IP address is assigned automatically (DHCP).
`SYST:COMM:NETW:IPAD:SET ON`
activates DHCP.

Manual control: See ["Address Mode"](#) on page 92

:SYSTem:COMMunicate:NETWork:IPADdress <Ipaddress>

The command enters the IP address. The entry is only activated after sending command `SYST:COMM:NETW:IPAD:SET`.

Parameters:

<Ipaddress> string
Range: 0.0.0.0. to ff.ff.ff.ff

Example: `SYST:COMM:NETW:IPAD 7.8.9.10`
enters the IP address of the instrument.

Example: `SYST:COMM:NETW:IPAD:SET`
activates all changes of the IP address settings.

Manual control: See ["IP Address"](#) on page 93

:SYSTem:COMMunicate:NETWork[:IPADdress]:GATeway <Gateway>

The command enters the IP address of the default gateway. The entry is only activated after sending command `SYST:COMM:NETW:IPAD:SET`.

Parameters:

<Gateway> string
Range: 0.0.0.0 to ff.ff.ff.ff

Example: `SYST:COMM:NETW:GAT 1.2.3.4`
enters the IP address of the default gateway.
`SYST:COMM:NETW:IPAD:SET`
activates all changes of the IP address settings.

Manual control: See ["Default Gateway"](#) on page 93

:SYSTem:COMMunicate:NETWork[:IPADdress]:SUBNet:MASK <Mask>

The command enters the Subnet mask. The entry is only activated after sending command `SYST:COMM:NETW:IPAD:SET`.

Parameters:

<Mask> string

Example: `SYST:COMM:NETW:SUBN:MASK 255.255.0.0`
enters the Subnet mask.
`SYST:COMM:NETW:IPAD:SET`
activates all changes of the IP address settings.

Manual control: See ["Subnet Mask"](#) on page 93

:SYSTem:COMMunicate:NETWork:RESource <Resource>

The command queries the VISA resource string. This string is used for remote control of the instrument with VXI-11 protocol.

Parameters:

<Resource> string

Example:

SYST:COMM:NETW:RES
queries the VISA resource string.
Response: TCPIP::192.1.2.3::INSTR

Manual control: See "[Visa Resource Strings](#)" on page 97

:SYSTem:COMMunicate:USB:RESource?

The command queries the visa resource string for remote control via the USB interface.

Return values:

<Resource> string

Example:

SYST:COMM:USB:RES?
queries the VISA resource string for remote control via the USB interface.
Response: USB::72::000000::INSTR

Usage: Query only

Manual control: See "[Visa Resource Strings](#)" on page 97

:SYSTem:COMMunicate:GPIB:RESource?

The command queries the visa resource string for remote control via the GPIB interface. This string is used for remote control of the instrument.

To change the GPIB address, use the command SYST:COMM:GPIB:ADDR.

Return values:

<Resource> string

Example:

SYST:COMM:GPIB:RES
queries the VISA resource string.
Response: GPIB::28::INSTR

Usage: Query only

Manual control: See "[Visa Resource Strings](#)" on page 97

:SYSTem:COMMunicate:SERial:RESource?

The command queries the visa resource string for the serial remote control interface. This string is used for remote control of the instrument.

Return values:

<Resource> string

Example: `SYST:COMM:SER:RES`
 queries the VISA resource string.
 Response: `ASRL1::INSTR`

Usage: Query only

Manual control: See "[Visa Resource Strings](#)" on page 97

:SYSTEM:COMMunicate:SERial:BAUD <Baud>

The command enters the baudrate for the serial remote control interface.

Parameters:

<Baud> 2400 | 4800 | 9600 | 19200 | 38400 | 57600 | 115200
 *RST: 115200

Example: `SYST:COMM:SER:BAUD 115200`
 enters the baudrate 115200.

Manual control: See "[RS232 using USB adapter](#)" on page 96

:SYSTEM:COMMunicate:SERial:PARity <Parity>

The command enters the parity for the serial remote control interface.

Parameters:

<Parity> NONE | ODD | EVEN
 *RST: NONE

Example: `SYST:COMM:SER:PAR NONE`
 selects parity NONE.

Manual control: See "[RS232 using USB adapter](#)" on page 96

:SYSTEM:COMMunicate:SERial:SBITS <Sbits>

The command enters the number of stop bits for the serial remote control interface.

Parameters:

<Sbits> 1 | 2
 *RST: 1

Example: `SYST:COMM:SER:SBIT 2`
 selects 2 stop bits.

Manual control: See "[RS232 using USB adapter](#)" on page 96

:SYSTEM:COMMunicate:SOCKet:RESource?

The command queries the visa resource string for remote control via the Socket interface.

Return values:

<Resource> string

Example: `SYST:COMM:SOCK:RES?`
Usage: Query only
Manual control: See "[Visa Resource Strings](#)" on page 97

:SYSTEM:DATE <Date>

The command queries / sets the date for the instrument-internal calendar.

This parameter is protected, in order to prevent accidental changes. It can be accessed with protection level 1, see `:SYSTEM:PROTECT<ch>[:STATE]` on page 630.

Parameters:

<Date> `<year>,<month>,<day>`

Example: `SYST:DATE?`
 Response: 2011,05,01 - it is the 1st of May in 2011.

Manual control: See "[Date](#)" on page 91

:SYSTEM:DISPlay:UPDate <Update>

The command switches the update of the display on/off. A switchover from remote control to manual control always sets the status of the update of the display to ON.

Parameters:

<Update> `0 | 1 | OFF | ON`
 *RST: `ON`

Example: `SYST:DISP:UPD OFF`
 switches update of displayed parameter values off.

Manual control: See "[On/Off GUI Update](#)" on page 88

:SYSTEM:DLOCK <Dlock>

This command (**D**isplay **L**Ock) disables the manual operation via the display, or enables it again (OFF).

The command disables also the front panel keyboard of the instrument including the LOCAL key.

Parameters:

<Dlock> `0 | 1 | OFF | ON`
 *RST: `0`

Example: `SYST:DLOC ON`
 activates the display lock. The instrument cannot be operated via the display until it has been enabled with `SYST:DLOC OFF`.

Manual control: See "[Display](#)" on page 101

SYSTem:ERRor:ALL?

The command queries all entries in the error queue and then deletes them.

Parameters:

<All> string

0

"No error", i.e the error queue is empty.

positive value

Positive error numbers denote device-specific errors.

negative value

Negative error numbers denote error messages defined by SCPI

Example:

SYST:ERR:ALL?

queries all entries in the error queue.

Response: 0, 'no error'

No errors have occurred since the error queue was last read out.

Usage:

Query only

SYSTem:ERRor:CODE:ALL?

The command queries all entries in the error queue and then deletes them. Only the error numbers are returned and not the entire error text.

Return values:

<All> string

0

"No error", i.e. the error queue is empty

positive value

Positive error numbers denote device-specific errors

negative value

Negative error numbers denote error messages defined by SCPI.

Example:

SYST:ERR:CODE:ALL

queries all entries in the error queue.

Response: 0

no errors have occurred since the error queue was last read out.

Usage:

Query only

SYSTem:ERRor:CODE[:NEXT]?

The command queries the oldest entry in the error queue and then deletes it. Only the error number is returned and not the entire error text.

Return values:

<Next>

string

0

"No error", i.e. the error queue is empty

positive value

Positive error numbers denote device-specific errors

negative value

Negative error numbers denote error messages defined by SCPI.

Example:`SYST:ERR:CODE`

queries the oldest entry in the error queue.

Response: 0

No errors have occurred since the error queue was last read out.

Usage:

Query only

SYSTem:ERRor:COUNT?

The command queries the number of entries in the error queue. If the error queue is empty, '0' is returned.

Return values:

<Count>

string

Example:`SYST:ERR:COUN`

queries the number of entries in the error queue.

Response: 1

One error has occurred since the error queue was last read out.

Usage:

Query only

SYSTem:ERRor[:NEXT]?

The command queries the oldest entry in the error queue and then deletes it.

The command is identical to the command `STATus:QUEue:NEXT`.

Return values:

<Next>

string

0

"No error", i.e. the error queue is empty

positive value

Positive error numbers denote device-specific errors

negative value

Negative error numbers denote error messages defined by SCPI.

Example:`SYST:ERR?`

queries the oldest entry in the error queue.

Response: 0, 'no error'

No errors have occurred since the error queue was last read out.

Usage:

Query only

Manual control: See ["History"](#) on page 60

:SYSTem:IDENtification <Identification>

Enables/disables selection of user defined "IDN String" and "OPT String" for the selected instrument (:SYST:LANG).

Note: While working in a emulation mode, the R&S SMA specific command set is disabled, i.e. the SCPI command `SYST:IDEN` will be discarded.

Parameters:

<Identification> AUTO | USER
 *RST: AUTO

Example:

```
SYST:IDEN USER
selects the user defined identification string.
SYST:IRES "Test Device"
defines the identification string 'test device'
*IDN?
Response: 'test device'
SYST:LANG 'HP8662'
selects command set of the HP generator. The R&S SMA's command set is disabled.
To return to the SCPI command set of the R&S SMA, use the HP command EX.
```

Manual control: See ["Identification Mode"](#) on page 95

:SYSTem:IRESpone <lresponse>

The command defines the identification string for selection user defined (SYST:IDEN USER).

Note: While working in a emulation mode, the instrument's specific command set is disabled, i.e. the SCPI command `SYST:IRES` will be discarded.

Parameters:

<lresponse> string

Example:

```
SYST:IDEN USER
selects an user-defined identification
SYST:IRES "Test Device"
defines the identification string 'test device'
*IDN?
Response: 'test device'
```

:SYSTem:KLOCK <Klock>

This command (**K**eyboard **L**OCK) disables the front panel keyboard of the instrument including the LOCAL key, or enables it again (OFF).

Parameters:

<Klock> 0 | 1 | OFF | ON
 *RST: OFF

Example:

SYST:KLOC ON
 activates the keyboard lock. The keyboard cannot be operated again until it has been enabled with SYST:KLOC OFF.

Manual control: See "[Keyboard](#)" on page 101

:SYSTem:LANGuage <Language>

The command selects the command set of a different generator. The GPIB command set of the R&S SMA no longer works.

After switching to a different command set, the return to the SCPI command set of the R&S SMA can only be performed by using the appropriate command of the selected command set. For example, the HP command EX returns to the instrument-specific GPIB command set (selection 'HPxxxx').

Note: The R&S SMA can be remote controlled via the several command sets of different generators. Please check for the corresponding Application Note at the download area of the product site on the Internet.

Setting parameters:

<Language> "SCPI" | "HP8662" | "HP864X" | "AF2040" | "RC3102"

Example:

SYST:LANG "HP8662"
 activates the HP 8662A command set

Usage: Setting only

Manual control: See "[Language](#)" on page 95

:SYSTem:ORESpone <Oresponse>

The command defines the OPT string for selection user defined (SYST:IDEN USER).

Note: While working in a emulation mode, the instrument's specific command set is disabled, i.e. the SCPI command SYST:ORES will be discarded.

Parameters:

<Oresponse> string

Example:

SYST:IDEN USER
 selects an user-defined identification
 SYST:ORES "Test Option"
 defines the OPT string 'test option'
 *OPT?
 Response: 'test option'

:SYSTem:PROTect<ch>[:STATe] <State>,<password>

The command activates and deactivates the specified protection level.

Suffix:	
<ch>	Indicates the protection level. There are several protection levels which disable specific service functions (authorized personnel of R&S Service Departments only).
Parameters:	
<State>	0 1 OFF ON
<password>	The respective functions are disabled when the protection level is activated. No password is required for activation. A password must be entered to deactivate the protection level. The password for the first level is 123456. This protection level can be used to lock-out internal adjustments.
Example:	<pre>SYST:PROT1 ON</pre> <p>activates protection level 1. Internal adjustments are only possible after deactivating the lock-out.</p> <pre>SYST:PROT1 OFF, 123456</pre> <p>deactivates protection level 1. Internal adjustments are enabled again.</p>
Usage:	SCPI confirmed
Manual control:	See " Protection Level/Password " on page 98

SYSTem:SERRor?

This command returns a list of all errors existing at the time when the query is started. This list corresponds to the display on the info page under manual control.

Return values:	
<Serror>	string
Example:	<pre>SYST:SERR</pre> <p>queries all errors existing in the error queue.</p>
Example:	<pre>Response: -221, 'Settings conflict', 153, 'Input voltage out of range'</pre> <p>The two returned errors have occurred since the error queue was last queried.</p>
Usage:	Query only

:SYSTem:STARtup:COMPLete?

The command queries if the startup of the instrument is completed.

Return values:	
<Complete>	0 1 OFF ON
*RST:	0

Example: `SYST:STAR:COMP`
 Response: 1
 The startup of the instrument is completed.

Usage: Query only

:SYSTem:TIME <Time>

The command queries / sets the time for the instrument-internal clock.

The parameter is protected, in order to prevent accidental changes. It can be accessed with protection level 1, see `:SYSTem:PROTECT<ch>[:STATe]` on page 630.

Parameters:

<Time> 0...23,0...59,0...59

Example: `SYST:TIME?`
 Response: 12, 0, 0 it is precisely 12 pm.

Manual control: See "Time" on page 91

SYSTem:VERSion?

The command queries the SCPI version with which the instrument complies.

Return values:

<Version> string

Example: `SYST:VERS`
 queries the SCPI version.
 Response: 1996
 The instrument complies with the version from 1996.

Usage: Query only

7.16 TEST Subsystem

The TEST system contains the commands for performing the routines as well as for direct manipulation of the hardware assemblies (`:TEST:DIReCt`).

The self tests return a "0" if the test is performed successfully, otherwise a value other than "0" is returned. None of the commands of this system have an *RST value.

NOTICE

Improper use may destroy the assembly!

The respective hardware assembly responds directly to the `:TEST:DIReCt` command; any safety mechanisms are bypassed. The command is used for servicing purposes and should not be applied by the user.

<code>:TEST<hw>:ALL:START</code>	633
<code>:TEST<hw>:ALL:RESult?</code>	633
<code>:TEST<hw>:DIRect</code>	633

`:TEST<hw>:ALL:START`

This command performs a selftest on all installed hardware options. The selftest result is queried with the command `:TEST<hw>:ALL:RESult?` on page 633.

Example:	<code>TEST:ALL:STAR</code> Starts the selftest
Usage:	Event
Manual control:	See "Selftest" on page 90

`:TEST<hw>:ALL:RESult?`

Queries the result of the performed selftest (command `:TEST<hw>:ALL:START` on page 633).

Return values:	<code><All></code> 0 1
Example:	<code>TEST:ALL</code> Starts the selftest <code>:TEST:ALL:RES?</code> Response: "0" on success, "1" on fail
Usage:	Query only
Manual control:	See "Selftest" on page 90

`:TEST<hw>:DIRect <HW_assembly>,<subadress>,<hex data string>`
`:TEST<hw>:DIRect? <HW_assembly>,<subadress>`

The respective hardware assembly responds directly to the command; any safety mechanisms are bypassed. This function is only available via remote control.

Example:	<code>TEST:DIR 'SSYN',0,#H12345678</code> <code>TEST:DIR? 'SSYN',0</code> Response: #H12345678
-----------------	--

7.17 TRIGger Subsystem

The TRIGger system contains the commands for selecting the trigger source for the RF and LF sweep. The trigger input connectors are configured in the `SOURCE:INPut` subsystem.

The trigger system of the R&S SMA is a simplified implementation of the SCPI trigger system. The TRIGger system differs from the SCPI system as follows:

- No INITiate command; the instrument behaves as if INITiate:CONTinuous ON were set.
- Under TRIGger several sweep subsystems exist.

Other commands associated with the trigger system of the R&S SMA can be found in the modulation and RF signal subsystems.

TRIGger<hw>

- Suffix TRIGger<1|2> is not permitted
- TRIGger0 activates the LF output.

Table 7-2: Cross-reference between the manual and remote control

R&S name	SCPI name	Command under manual control
AUTO	IMMediate	"Auto" mode
SINGle	BUS	"Single" mode.
EXTernal	EXTernal	"Ext Single" and "Ext Step" mode. Use command LFO:SWEep:MODE to select between the two sweep modes.
EAUTo	-	"Ext Start/Stop" mode.

TRIGger0[:SWEep]:SOURce.....	634
:TRIGger<hw>:LFFSweep:SOURce.....	634
:TRIGger<hw>:FSWweep[:IMMediate].....	635
:TRIGger<hw>:FSWweep:SOURce.....	635
:TRIGger<hw>:PSWweep[:IMMediate].....	636
:TRIGger<hw>:PSWweep:SOURce.....	637
:TRIGger<hw>[:SWEep][:IMMediate].....	637
:TRIGger<hw>[:SWEep]:SOURce.....	638

TRIGger0[:SWEep]:SOURce <Source>

:TRIGger<hw>:LFFSweep:SOURce <Source>

The command sets the trigger source for the LF sweep. The trigger is triggered by the command :SOURce:LFOuTput:SWEep[:FREQuency]EXECute.

The names of the parameters correspond directly to the various settings under manual control. SCPI uses other names for the parameters; these names are also accepted by the instrument. The SCPI names should be used if compatibility is an important consideration.

An overview of the various names is given in the [table 7-2](#).

Parameters:

<Source>

AUTO | IMMEDIATE | SINGLE | BUS | EXTERNAL | EAUTO

AUTO|IMMEDIATE

The trigger is free-running, i.e. the trigger condition is fulfilled continuously. As soon as one sweep is finished, the next sweep is started.

SINGLE|BUS

One complete sweep cycle is triggered by the GPIB commands `[:SOURCE] :LFOutput :SWEep [:FREQuency] :EXECute` or `*TRG`.

The mode has to be set to AUTO (`[:SOURCE] :LFOutput :SWEep [:FREQuency] :MODE`).

EXTERNAL

The sweep is triggered externally via the INST TRIG connector.

EAUTO

The sweep is triggered externally via the INST TRIG connector. As soon as one sweep is finished, the next sweep is started. A second trigger event stops the sweep at the current frequency, a third trigger event starts the trigger at the start frequency, and so on.

*RST: SINGLE

Example:

```
TRIG:LFFS:SOUR EXT
```

selects triggering with an external trigger.

:TRIGger<hw>:FSWeep[:IMMEDIATE]

The command immediately starts an RF frequency sweep cycle.

The command is only effective for sweep mode "Single" (`SOUR :SWE :FREQ :MODE AUTO` in combination with `TRIG :FSW :SOUR SING`).

The command corresponds to the manual control "Execute Single Sweep".

Example:

```
SWE:FREQ:MODE AUTO
```

sets the triggered sweep mode, i.e. a trigger is required to start the sweep.

```
TRIG:FSW:SOUR SING
```

sets the "Single" trigger mode, i.e. a trigger starts a single sweep.

```
TRIG:FSW
```

starts a single RF frequency sweep.

Usage:

Event

:TRIGger<hw>:FSWeep:SOURce <Source>

The command sets the trigger source for the RF frequency sweep.

The names of the parameters correspond directly to the various settings under manual control. SCPI uses other names for the parameters; these names are also accepted by the instrument. The SCPI names should be used if compatibility is an important consideration.

An overview of the various names is given in [table 7-2](#).

Parameters:

<Source>

AUTO | IMMEDIATE | SINGLE | BUS | EXTERNAL | EAUTO

AUTO|IMMEDIATE

The trigger is free-running, i.e. the trigger condition is fulfilled continuously. As soon as one sweep is finished, the next sweep is started.

SINGLE|BUS

One complete sweep cycle is triggered by the GPIB commands `[:SOURce<hw>] :SWEep [:FREQuency] :EXECute, : TRIGger<hw> :FSweep [:IMMEDIATE]` or `*TRG`. The mode has to be set to AUTO (`:SOURce :SWEep :FREQuency :MODE AUTO`).

EXTERNAL

The sweep is triggered externally via the INST TRIG connector.

EAUTO

The sweep is triggered externally via the INST TRIG connector. As soon as one sweep is finished, the next sweep is started. A second trigger event stops the sweep at the current frequency, a third trigger event starts the trigger at the start frequency, and so on.

*RST: SINGLE

Example:

TRIG:FSW:SOUR EXT

selects triggering with an external trigger.

Manual control:

See "[Mode - Frequency Sweep](#)" on page 191

:TRIGger<hw>:PSweep[:IMMEDIATE]

The command immediately starts an RF level sweep.

The command is only effective for sweep mode "Single" (`SOURce :SWEep :POWer :MODE AUTO` in combination with `TRIG :PSW :SOUR SING`).

The command corresponds to the manual control "Execute Single Sweep".

Example:

SWE:POW:MODE AUTO

selects the triggered sweep mode, i.e. a trigger is required to start the sweep.

TRIG:PSW:SOUR AUTO

sets the Single trigger mode, i.e. a trigger starts a single sweep.

TRIG:PSW

starts a single RF level sweep.

Usage:

Event

:TRIGger<hw>:PSWEEP:SOURce <Source>

The command sets the trigger source for the RF level sweep.

The names of the parameters correspond directly to the various settings under manual control. SCPI uses other names for the parameters; these names are also accepted by the instrument. The SCPI names should be used if compatibility is an important consideration.

An overview of the various names is given in [table 7-2](#).

Parameters:

<Source>

AUTO | IMMEDIATE | SINGLE | BUS | EXTERNAL | EAUTO

AUTO|IMMEDIATE

The trigger is free-running, i.e. the trigger condition is fulfilled continuously. As soon as one sweep is finished, the next sweep is started.

SINGLE|BUS

One complete sweep cycle is triggered by the GPIB commands `[:SOURce<hw>] :SWEep:POWer:EXECute, :TRIGger<hw>:PSWEEP [:IMMEDIATE]` or `*TRG`. The mode has to be set to AUTO (`:SOURce:SWEep:LEVel:MODE AUTO`).

EXTERNAL

The sweep is triggered externally via the INST TRIG connector.

EAUTO

The sweep is triggered externally via the INST TRIG connector. As soon as one sweep is finished, the next sweep is started. A second trigger event stops the sweep at the current frequency, a third trigger event starts the trigger at the start frequency, and so on.

*RST: SINGLE

Example:

TRIG:PSW:SOUR EXT

selects triggering with an external trigger.

Manual control:

See "[Mode - Level Sweep](#)" on page 197

:TRIGger<hw>[:SWEep][:IMMEDIATE]

The command starts all sweeps which are activated for the respective path. The command starts all sweeps which are activated.

The sweep to be executed depends on the respective MODE setting (`:SOUR:SWEep:POW|FREQ:MODE` and `:SOUR:LFO:SWEep[:FREQ]:MODE`).

The command corresponds to the manual-control command "Execute Trigger".

Example:

TRIG

starts all active sweeps.

Usage:

Event

:TRIGger<hw>[:SWEep]:SOURce <Source>

The command sets the trigger source for all sweeps.

The names of the parameters correspond directly to the various settings under manual control. SCPI uses other names for the parameters; these names are also accepted by the instrument. The SCPI names should be used if compatibility is an important consideration.

An overview of the various names is given in the [table 7-2](#).

Parameters:

<Source>

AUTO | IMMEDIATE | SINGLE | BUS | EXTERNAL | EAUTO

AUTO|IMMEDIATE

The trigger is free-running, i.e. the trigger condition is fulfilled continuously. As soon as one sweep is finished, the next sweep is started.

SINGLE|BUS

One complete sweep cycle is triggered by the GPIB commands :SOURce:SWEep:POWer|FREQuency:EXEC, TRIGger:PSWEEP|FSWEEP:IMMEDIATE or *TRG.

If :SOURce:SWEep:POWer:MODE is set to STEP, one step is executed.

The mode has to be set to AUTO.

EXTERNAL

The sweep is triggered externally via the INST TRIG connector.

EAUTO

The sweep is triggered externally via the INST TRIG connector. As soon as one sweep is finished, the next sweep is started. A second trigger event stops the sweep at the current frequency, a third trigger event starts the trigger at the start frequency, and so on.

*RST: SINGLE

Example:

TRIG0:SOUR EXT

selects triggering with an external trigger. The trigger is input via the INST TRIG connector.

Usage:

Setting only

Manual control:

See "[Mode - LF Sweep](#)" on page 292

7.18 UNIT Subsystem

The UNIT subsystem contains the commands specifying which units are valid if no unit is indicated in a command. These settings are valid for the entire instrument.

Remote control emulation of the HP 8662A signal generator for the R&S SMA

:UNIT:ANGLE <Angle>

The command defines the default unit for the phase modulation angle. It is not valid for other commands which determine angle values, e.g. RF phase. It does not influence the manual control parameter unit and the display.

Parameters:

<Angle> DEGree | DEGRee | RADian
*RST: RADian

Example:

UNIT:ANGL DEG
sets default unit DEG for all commands which determine angle values.

:UNIT:POWer <Power>

The command defines the default unit for power. It is valid for all commands which determine power values. It does not influence the manual control parameter unit and the display.

Parameters:

<Power> V | DBUV | DBM
*RST: DBM

Example:

UNIT:POW V
sets default unit V for all commands which determine power values.

7.19 Remote control emulation of the HP 8662A signal generator for the R&S SMA



The R&S SMA can be remote controlled via the several command sets of different generators. Please check for the corresponding Application Note at the download area of the product site on the Internet.

The R&S SMA can be remote-controlled using the instrument-specific GPIB command set as well as an emulated command set of the HP 8662A generator.

With manual operation, the command set is selected with the parameter "Setup > Remote Channel Settings > Language"(see "[Language](#)" on page 95).

When using the emulated command set of the HP 8662A generator, the instruments identifies itself either as R&S SMA or as HP86xx generator when queried with common command *IDN?. The selection can only be performed with manual operation he Setup menu "Remote Channel Settings"; under "'*IDN? Identification".

Remote control emulation of the HP 8662A signal generator for the R&S SMA

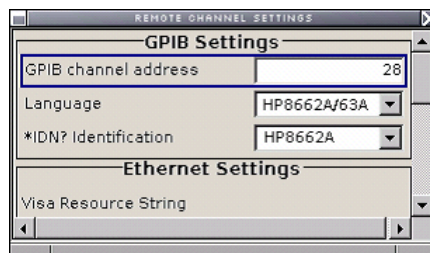

With remote operation, the HP 8662A command set is selected using the GPIB command `SYSTem:LANGUage "HP8662"`. The GPIB command set of the R&S SMA no longer works. The HP command EX returns to the instrument-specific GPIB command set.

The selected command set is saved when the instrument is switched off, which means that when the instrument is switched on again, it starts up with the same setting with which it was switched off. The emulation parameters are not persistent and are lost when the instrument is switched off.

7.19.1 HP 8662A commands

The emulation software simulates the HP 8662A data model in the execution unit and transforms the HP 8662A parameters into R&S SMA parameters.

This mapping occurs in only one direction: Setting commands that arrive via the remote-control interface modify the HP 8662A parameters. These parameters are converted into R&S SMA parameters and written to the database. Modifying the R&S SMA parameters in any other manner, e.g. via manual operation, causes no changes to the HP 8662A parameters of the emulation software. While this is insignificant in pure remote-control operation, it can lead to inconsistencies when you use both manual and remote control.

Limitations and special characteristics of the emulation are explained in the Comment column of the following table.

Command	Function	*	Comment
@1	Write require service mask		The status system of the HP 8662A is not compatible with the status system implemented in the R&S SMA in accordance with IEEE 488.2.
@2	Deferred execution mode	X	Command is ignored.
@3	Immediate execution mode	X	Command is ignored.
AM	AM depth	X	
AO	AM State OFF	X	Alias = A0
AP	Amplitude	X	Alias = BLSQ, SP88, BLAP88

Remote control emulation of the HP 8662A signal generator for the R&S SMA

Command	Function	*	Comment
AS	Autosequence	X	<p>The command sequentially and cyclically activates the instrument settings saved in registers.</p> <p>Limitations:</p> <p>Since the end of a sweep is not detected in the R&S SMA, a saved instrument setting with a sweep cannot be emulated.</p> <p>The timing of this function is not defined ("as fast as it can"). Therefore, the time performance of the emulation software can be expected to be very different from that of an HP 8662A.</p>
BLR1	Knob hold		Keyboard/rotary knob commands are not implemented. The emulation is not intended to simulate manual operation.
BLR2	Knob increment		See BLR1
BLX6	All markers off		The R&S SMA has no sweep marker.
BS	Backspace		See BLR1
CT	Configure trigger	X	
DN	Step down	X	[AM AP FA FB FM FR FS N3 X1 X2 X3 X4 X5] DN
EX	Switch back to native remote-control mode	X	

Remote control emulation of the HP 8662A signal generator for the R&S SMA

Command	Function	*	Comment
FA	Start frequency	X	Different behavior: In the HP 8662A, the FA, FB, FS and FR sweep frequencies are maintained as separate and unlinked parameters. In the R&S SMA, the start and end frequencies, center frequency and span are linked. In the HP 8662A, however, the FR command sets both the frequency in the CW mode as well as the center frequency in the Sweep mode. The current and internal SweepConfiguration state determines which of the competing and possibly inconsistent parameter sets (FA, FB) or (FR, FS) is set on the R&S SMA. When setting the FA or FB values via remote control, SweepConfiguration changes to the StartStop state and the set (FA, FB) is used. When setting the FS value via remote control, SweepConfiguration changes to the Span state and the set (FR, FS) is used. Span is the initial state of SweepConfiguration.
FB	Stop frequency	X	See FA
FM	FM State ON, FM depth	X	
FR	Frequency or center frequency	X	See FA
FS	Frequency span	X	
IS	Increment setting	X	[AM AP FA FB FM FR FS N3 X1 X2 X3 X4 X5] IS

Remote control emulation of the HP 8662A signal generator for the R&S SMA

Command	Function	*	Comment
L1	Learn front panel	X	The HP 8662A has two Learn modes: The Fast Learn mode, transmitting 11 bytes per setting, and the Front Panel Learn mode, transmitting 128 bytes. The documentation of the HP 8662A does not provide a complete description of the content of the instrument settings contained in the binary block. As a result, binary blocks that have been generated or modified by a controller or by emulation software cannot be played back to an HP 8662A. However, this does not affect the data exchange between a controller and emulation software on an R&S SMA. Queries must be terminated with a question mark ("?").
L2	Fast learn mode	X	See L1
M0	Modulation off	X	Alias = MO
M1	Internal 400 Hz (mod)	X	
M2	Internal 1 kHz (mod)	X	
M3	External AC (mod)	X	
M4	External DC (mod)	X	
MS	Read status key message	X	Queries must be terminated with a question mark ("?").
N1	100 steps (lin sweep)	X	
	100 steps (lin sweep)	X	
N3	Set step size (lin sweep)	X	
N4	Log 10% steps (log sweep)	X	
N5	Log 1% steps (log sweep)	X	
R1 / R2 / R3 / R4 / R5	Resolution x10,(/10), knob off, knob hold, knob increment		See BLR1
RC	Recall instrument settings from register	X	
RD	Knob, CCW (down)		See BLR1

Remote control emulation of the HP 8662A signal generator for the R&S SMA

Command	Function	*	Comment
RM	Read require service mask		Query commands must be terminated with a question mark ("?").
RU	Knob CW (up)		See BLR1
SP00		X	Alias BLAP00
SP10		X	Alias BLAP10
SP11		X	Alias BLAP11
SP12		X	Alias BLAP12
SP30	Amplitude reference off		Alias = BLAP30 Affects only manual operation (knob), see BLR1.
SP31	Amplitude reference on		Alias = BLAP31 Affects only manual operation (knob), see BLR1.
SP40	External AM off	X	Alias = BLAP40
SP41	Int FM + ext AM (ac)	X	Alias = BLAP41
SP42	Int FM + ext AM (dc)	X	Alias = BLAP42
SP50..52	AUX FM		Alias = BLAP50 to 52 Not supported, since the R&S SMA does not have a second modulation input.
SP60..62	PSK toggle		Alias = BLAP60 to 62 Affects only manual operation with up/down keys, see BLR1.
SP80	SP10 to 62 off	X	Alias = BLAP80
SP81	Switch unit of level display		Alias = BLAP81 No corresponding R&S SMA parameter available.
SP85	Amplitude correction off	X	Alias = BLAP85
SP86	Amplitude correction on	X	Alias = BLAP86
SP87	HP-IB operator request response	NN	Alias = BLAP87
SQ	Sequence	X	
SS	Set sequence	X	Alias = BLST
ST	Store current instrument settings in register	X	
T1 to T3	Sweep dwell time 0.5 ms to 2 ms		R&S SMA dwell time value range ≥ 10 ms.

Remote control emulation of the HP 8662A signal generator for the R&S SMA

Command	Function	*	Comment
T4 / T5	10/100 ms/sweep	X	
TR	Trigger	X	
UP	Step up	X	[AM AP FA FB FM FR FS N3 X1 X2 X3 X4 X5] UP
W1	Sweep off	X	
W2	Auto sweep	X	
W3	Manual sweep	X	
W4	Single sweep	X	
X1 to X7	Sweep marker		The R&S SMA has no sweep marker.
Y0	Remote stepped sweep (RSS) clear	X	Alias = YO
Y1 / Y2	RSS with display	X	
Y3	RSS without display	X	

*X = implemented

7.19.2 Value ranges and error messages

The permissible value ranges for the setting parameters of the HP 8662A and R&S SMA are very different. No effort was made to simulate the HP 8662A limitations in the emulation software. For this reason, setting values permitted in emulation software cannot be transferred to an HP 8662A.

Most error messages and codes output by the R&S SMA are generated by deeper software layers and are not compatible with the highly instrument-specific HP 8662A error codes. A very simple mechanism for mapping the R&S SMA error codes to the HP 8662A error codes is used. It maps all R&S SMA errors to error code 43 (Wrong entry protocol. Entry ignored.) of the HP 8662A.

However, the errors detected by the execution unit of the emulator are immediately converted to suitable HP 8662A error codes where possible.

8 Maintenance

The instrument does not need periodic maintenance. Only the cleaning of the instrument is essential. The outside of the instrument is suitably cleaned using a soft, line-free dust cloth. Make sure that the air vents are not obstructed.

⚠ WARNING**Shock hazard**

Before cleaning the instrument, make sure that the instrument is switched off and disconnected from all power supplies.

NOTICE**Instrument damage caused by cleaning agents**

Cleaning agents contain substances that may damage the instrument, e.g. cleaning agents that contain a solvent may damage the front panel labeling or plastic parts.

Never use cleaning agents such as solvents (thinners, acetone, etc), acids, bases, or other substances.

The outside of the instrument can be cleaned sufficiently using a soft, lint-free dust cloth.

Follow the instructions in the service manual and the safety instructions when exchanging modules or ordering spares. The order no. for spare parts is included in the service manual. The service manual includes further information particularly on troubleshooting, repair, exchange of modules and alignment.

The address of our support center and a list of all Rohde & Schwarz service centers can be found at the beginning of this manual.

8.1 Storing and Packing

The storage temperature range of the instrument is given in the data sheet. If the instrument is to be stored for a longer period of time, it must be protected against dust.

Repack the instrument as it was originally packed when transporting or shipping. The two protective foam plastic parts prevent the control elements and connectors from being damaged. The antistatic packing foil avoids any undesired electrostatic charging to occur.

If you do not use the original packaging, use a sturdy cardboard box of suitable size and provide for sufficient padding to prevent the instrument from slipping inside the package. Wrap antistatic packing foil around the instrument to protect it from electrostatic charging.

9 Error Messages

This chapter describes the error messages of the R&S SMA. The error messages are output in the "Info" line on the screen and entered in the error/event queue of the status reporting system.

A great variety of different messages such as status messages, error messages, warnings or information are displayed in the header field of the screen. Some error messages require that the error must be eliminated before correct instrument operation can be ensured. The info window with a list of current messages and a detailed description of each message can be opened with the INFO key.

In the remote control mode, error messages are entered in the error/event queue of the status reporting system and can be queried with the command `SYSTem:ERRor?`. If the error queue is empty, 0 ("No error") is returned.

9.1 Status Information

The status messages are displayed in the header section of the screen. The status information gives the user an overview of the main operating states and settings of the instrument. The states are indicated for information only and do not necessitate any action by the user. Status information is displayed between the frequency and level fields, at the left of the info line or in the info line itself.

9.1.1 Status information displayed between the frequency and level fields

This chapter gives an overview of the status messages displayed between the frequency and level fields.

RF OFF

The RF output is switched off

MOD OFF

All modulations are switched off

FREQ OFFSET

A frequency offset is set.

The frequency entered and displayed in the "Frequency" field takes any set frequency offset into consideration, e.g. an offset set for a downstream instrument. This means that with a frequency offset the frequency displayed in the header does not correspond to the frequency at the RF output, but rather to the frequency at the output of the downstream instrument.

This allows the target frequency at the output of a downstream instrument to be entered in the frequency field. The signal generator changes the RF output frequency according to the entered offset.

However, the frequency entered and displayed in the "Frequency/Phase" dialog of the "RF" function block always corresponds to the RF output frequency. Any frequency offset is not taken into consideration.

The correlation is as follows:

Freq in header = RF output frequency (= Freq in dialog) + Freq offset (= Offset in dialog)

OVERLOAD

The power of the external signal applied to the RF output is too high. The overload protection is tripped and the connection between the RF output and attenuator is interrupted. The overload protection is reset by pressing the RF ON/OFF key. The RF input is activated when the overload protection is reset.

LEVEL OFFSET

A level offset is set.

The level entered and displayed in the "Level" field takes the offset of any downstream attenuators/amplifiers into consideration by way of calculation. This means that with a level offset the level displayed in the header does not correspond to the level at the RF output, but rather to the level at the output of the downstream instrument.

This allows the target level at the output of downstream instruments to be entered. The signal generator changes the RF output level according to the set offset.

However, the level entered and displayed in the "Level" dialog of the "RF" function block always corresponds to the RF output level. Any level offset is not taken into consideration.

The correlation is as follows:

Level in header = RF output level (= Level in dialog) + Level offset

EXT REF

An external reference is used.

The external signal with selectable frequency and defined level must be input at the REF IN connector. It is output at the REF OUT connector.

BUSY

A setting or calculation is executed.

9.1.2 Status information displayed to the left of the Info line

This chapter gives an overview of the status messages displayed to the left of the Info line.

REMOTE

The instrument is remote controlled.

The keys on the front panel are usable, but all parameters are in read only mode.

The LOCAL key switches the instrument from remote control to manual operation. The current command must be fully processed before the mode is switched, otherwise the instrument switches immediately back to remote control.

REM-LLO

The instrument is remote (**REM**ote) controlled. The LOCAL key is disabled by remote control with the command **LLO** (**LocalLockOut**).

The keys on the front panel are usable, but all parameters are in read only mode.

The instrument can be switched from remote control to manual operation by means of remote control only (e.g. with the Visual Basic command `CALL IBLOC (generator%)` or by `&NREN`).

LOC-LLO

For operating directly the instrument is placed from remote control to manual operation (Local State). The LOCAL key was disabled by remote control with the command **LLO** (**LocalLockOut**).

With the next activating of the remote control mode, the instrument cannot be switched to manual operation by the operator. The status information changes to "REM-LLO".

The instrument can be switched to manual operation by means of remote control only (e.g. with the Visual Basic command `CALL IBLOC (generator%)`).

9.1.3 Status information displayed in the Info line

This chapter gives an overview of the status messages displayed in the Info line.

RFSweep / LevelSweep / LFSweep

The indicated sweep is enabled.

ALC On / Auto / S&H

The status of the automatic level control is indicated:

- ON
automatic level control permanently on
- Auto
automatic level control is automatically adapted to the operating states
- S&H
automatic level control off, recalibration of the level whenever the level or frequency is set (sample and hold mode)

ListMode

List mode is active.

The values of the frequency/level pairs in the selected list are set for the chosen dwell time.

AttFixed

Attenuator fixed mode is active.

The uninterrupted level settings are made in a fixed range without attenuator switching. The variation range is set automatically when this mode is activated. The range is displayed under "Attenuator Fixed Range" in the "Level" dialog.

UCorr

User Correction is active.

The level is corrected by the given values in the selected user correction list. Correction is performed by the user-defined list values being added to the output level for the respective RF frequency. With frequencies which are not contained in the list, the level correction is determined by interpolation of the closest correction values.

OvenCold

The reference oscillator has not yet reached its nominal frequency.

When switching on from the STANDBY mode, the specified frequency accuracy is reached immediately. If the power switch was switched off, the reference oscillator needs some warm-up time to reach its nominal frequency. During this period of time, the output frequency does not yet reach its final value either.

9.2 Error Messages

Messages indicate errors in the instrument. They are displayed in the info line in different colors depending on their importance and display duration. Errors (e.g. no calibration data) are displayed in red, information (e.g. file not found) and warnings in black. Warnings indicate less significant errors (e.g. the instrument operates outside specified data).

9.2.1 Volatile messages

Volatile messages report automatic settings in the instrument (e.g. switching off of incompatible types of modulation) or on illegal entries that are not accepted by the instrument (e.g. range violations). They are displayed in the info line on a yellow background. They are displayed on top of status information or permanent messages.

Volatile messages do not normally demand user actions and disappear automatically after a brief period of time. They are stored in the history, however.

SCPI command: `SYSTem:ERRor:ALL?` or `SYSTem:ERRor[:NEXT]?`

9.2.2 Permanent messages

Permanent messages are displayed if an error occurs that impairs further instrument operation, e.g. a hardware fault. The error signaled by a permanent message must be eliminated before correct instrument operation can be ensured.

The message is displayed until the error is eliminated. It covers the status display in the info line. After error elimination, the message automatically disappears and is also recorded in the history.

SCPI command: `SYSTem:SERRor?`

9.3 SCPI-Error Messages

The SCPI error messages are the same in all SCPI instruments. Detailed information and an overview of all error messages as defined in SCPI standard can be found in the corresponding documentation.

The errors are assigned negative numbers. The error text being entered into the error/event queue or being displayed is printed in bold face on the left together with the error code. Below the error text, there is an explanation as to the respective error.

9.4 Device-Specific Error Messages

The following table contains all error messages specific for the instrument in alphabetical order, as well as an explanation of the error situation. The positive error codes mark the errors specific of the instrument.

The device-specific error messages set bit 3 in the ESR register.



The index provides a list of the error messages sorted according to their error codes.

Error Code	Error	Description	Remedy
50	Extern reference out of range or disconnected	External reference is selected but no external signal is applied or the signal is out of range.	<ul style="list-style-type: none"> Check the selected reference signal source (internal or external) in the "Setup > Reference Oscillator" dialog. Change setting to 'internal' if no appropriate external source is available.
140	This modulation forces other modulations off	A modulation has been switched on which cannot be used at the same time as an already active modulation. The previous modulation has been switched off. Example: Enabling FM modulation switches PM modulation off.	
180	Adjustment failed	Adjustment could not be executed	The adjustment data have to be generated first by an internal or external adjustment or to be loaded into the device (see chapter 5.2.3.1, "Internal Adjustments" , on page 82.
182	Adjustment data missing	Adjustment data are missing.	The adjustment data have to be generated first by an internal or external adjustment or to be loaded into the instrument.

Device-Specific Error Messages

Error Code	Error	Description	Remedy
183	Adjustment data invalid	Adjustment data are invalid and must be restored.	The adjustment data have to be generated again by an internal or external adjustment or to be loaded into the instrument.
200	Cannot access hardware	The data transmission to a module was unsuccessful.	The module is not installed, not properly installed or missing.
201	Hardware revision out of date	A later version of certain parts of the instrument is necessary to execute the function selected.	The driver does not support the installed version of a module.
202	Cannot access the EEPROM	A error occurs when writing or reading a EEPROM.	The EEPROM might be defect and has to be replaced.
203	Invalid EEPROM data	Reading a EEPROM is possible, however the data are inconsistent.	
204	Driver initialization failed	Initialization of a driver fails when booting the instrument firmware.	The driver is not compatible with the hardware or software configuration of the instrument.
241	No current list	There is no list selected. To execute the required operation, a list has to be selected in the related menu.	If no list is available, a new list must be created.
242	Unknown list type specified	The list type selected is not valid for the required operation. For instance, the file extension for waveform list files is *.wv. It is not possible to enter another file extension when selecting a list.	Check the selected list type.
460	Cannot open file	The selected file can not be opened.	Check the path and file name.
461	Cannot write file	The file can not be written.	Check if the file is read-only.
462	Cannot read file	The file can not be read.	Check if the file contents are compatible with the file type.
463	Filename missing	The required operation cannot be executed because the file name is not specified.	A file name has to be entered when creating a new list.
464	Invalid filename extension	The file extension is not valid for the required operation.	Check the file extension. For instance, the file extension for waveform list files is *.wv. It is not possible to enter another file extension when storing a list.
465	File contains invalid data	The selected file contains data that is not valid for the file type. The file extension determines the data that is valid for this file type. If the file extension is changed the lists are no longer recognized and the data are therefore invalid. Example: the extension of a waveform file (= *.wv) was changed to *.txt	Check the file extension.

A Hardware Interfaces

This section covers hardware related topics, like pin assignment of the GPIB bus interface.

The remote control interfaces are described in details in [chapter 6, "Remote Control Basics"](#), on page 314.

All other interfaces are described in [chapter 2.1, "Front Panel Tour"](#), on page 15 and [chapter 2.2, "Rear Panel Tour"](#), on page 21.

For specifications refer to the data sheet.

A.1 GPIB Bus Interface

Pin assignment

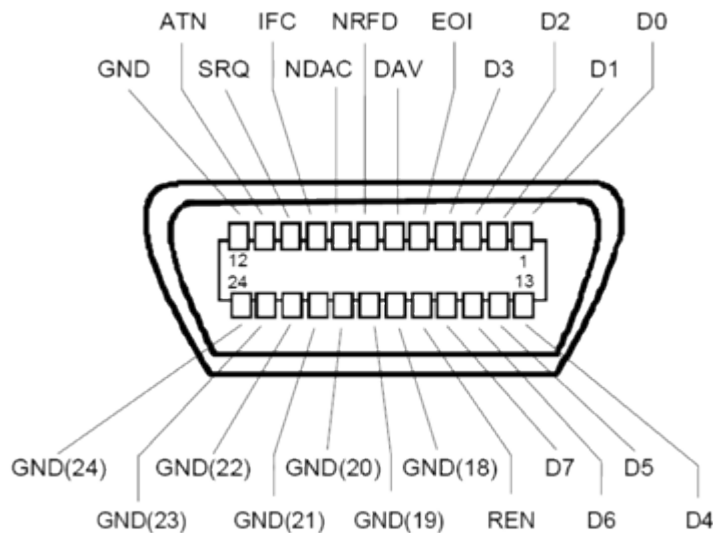

Fig. 1-1: Pin assignment of GPIB bus interface

Bus lines

- Data bus with 8 lines D0 to D7:
The transmission is bit-parallel and byte-serial in the ASCII/ISO code. D0 is the least significant bit, D7 the most significant bit.
- Control bus with five lines:
IFC (Interface Clear): active LOW resets the interfaces of the instruments connected to the default setting.
ATN (Attention): active LOW signals the transmission of interface messages, inactive HIGH signals the transmission of device messages.

SRQ (Service Request): active LOW enables the connected device to send a service request to the controller.

REN (Remote Enable): active LOW permits switchover to remote control.

EOI (End or Identify): has two functions in connection with ATN:

- ATN=HIGH active LOW marks the end of data transmission.
- ATN=LOW active LOW triggers a parallel poll.

- Handshake bus with three lines:

DAV (Data Valid): active LOW signals a valid data byte on the data bus.

NRFD (Not Ready For Data): active LOW signals that one of the connected devices is not ready for data transfer.

NDAC (Not Data Accepted): active LOW signals that the instrument connected is accepting the data on the data bus.

Interface Functions

Instruments which can be controlled via GPIB bus can be equipped with different interface functions. The interface function for the R&S SMA are listed in the following table.

Table 1-1: GPIB bus interface functions

Control character	Interface function
SH1	Handshake source function (source handshake), full capability
AH1	Handshake sink function (acceptor handshake), full capability
L4	Listener function, full capability, de-addressed by MTA.
T6	Talker function, full capability, ability to respond to serial poll, deaddressed by MLA
SR1	Service request function (Service Request), full capability
PP1	Parallel poll function, full capability
RL1	Remote/Local switch over function, full capability
DC1	Reset function (Device Clear), full capability
DT1	Trigger function (Device Trigger), full capability

A.2 AUX I/O Connector

Table 1-2: Pin assignment of the AUX I/O Connector connector

Pin	Signal	Description
1	FHOP_DATA	Data input for Fast Hopping list mode. See chapter 5.3.7.4, "List Mode" , on page 202
2	Ground \perp	Ground
3	FHOP_CLK	Clock input for Fast Hopping list mode. See chapter 5.3.7.4, "List Mode" , on page 202

Pin	Signal	Description
4	FHOP_STRB	Strobe input for Fast Hopping list mode. See chapter 5.3.7.4, "List Mode" , on page 202
5	RF OFF	Input for fast switching of the RF output. Active High (1) switches the RF output off. A subsequent Active Low (0) switches the RF output on again. Switching is performed very fast (10us). However, the attenuation of the switched off output is considerably less than after regular switch-off, because the attenuator is not set to maximum attenuation.
6	INST TRIG	Input for external triggering of the analog modulations, sweeps and List mode. HOP input for controlling the frequency hop mode with external source in List mode.
7	BLANK	Output for blank signal. This signal marks the blank times (invalid level indication). The signal is generated automatically.
8	OPC	Output for Operation Complete line. Active High signals that all remote control commands have been executed. The output is always active.
9 .. 10	Ground \perp	Ground
11 .. 26	FM_DAT	Parallel data input with 16-bit word width for digital FM modulation data. The FM-Data bus is directly connected to the DDS of the synthesiser module. Thus, very fast frequency hop (settling times of 10 us) is possible for frequency bandwidth up to 80 MHz. See chapter 5.4.3, "Frequency Modulation (FM)" , on page 218

List of Commands

*CAL?	354
*CLS	354
*ESE	355
*ESR?	355
*IDN?	355
*IST?	355
*OPC	356
*OPT?	356
*PCB	356
*PRE	356
*PSC	356
*RCL	357
*RST	357
*SAV	357
*SRE	357
*STB?	358
*TRG	358
*TST?	358
*WAI	358
:CALCulate[:POWer]:SWEep:FREQuency:MATH<ch>:STATe	394
:CALCulate[:POWer]:SWEep:FREQuency:MATH<ch>:SUBTract	394
:CALCulate[:POWer]:SWEep:POWer:MATH<ch>:STATe	395
:CALCulate[:POWer]:SWEep:POWer:MATH<ch>:SUBTract	395
:CALCulate[:POWer]:SWEep:TIME:GATE<ch>:FEED	393
:CALCulate[:POWer]:SWEep:TIME:GATE<ch>:STATe	394
:CALCulate[:POWer]:SWEep:TIME:GATE<ch>:AVERAge?	392
:CALCulate[:POWer]:SWEep:TIME:GATE<ch>:MAXimum?	393
:CALCulate[:POWer]:SWEep:TIME:GATE<ch>:START	393
:CALCulate[:POWer]:SWEep:TIME:MATH<ch>:STATe	395
:CALCulate[:POWer]:SWEep:TIME:MATH<ch>:SUBTract	396
:CALibration:ALL[:MEASure]?	361
:CALibration:CSYNthesis[:MEASure]?	361
:CALibration:DME[:MEASure]?	361
:CALibration:LFOutput[:MEASure]	363
:CALibration<hw>:FMOffset[:MEASure]?	362
:CALibration<hw>:FREQuency[:MEASure]?	362
:CALibration<hw>:LEVel:EXTern:DATA	362
:CALibration<hw>:LEVel[:MEASure]?	362
:CSYNthesis:FREQuency	363
:CSYNthesis:FREQuency:STEP	364
:CSYNthesis:FREQuency:STEP:MODE	365
:CSYNthesis:OFFSet	365
:CSYNthesis:OFFSet:STATe	365
:CSYNthesis:STATe	364
:DEvice:PRESet	359

:DIAGnostic:INFO:OTIME?	367
:DIAGnostic:INFO:POCOUNT?	367
:DIAGnostic<hw>:BGInfo:CATalog?	366
:DIAGnostic<hw>:BGInfo?	366
:DISPlay:ANNotation:AMPLitude	368
:DISPlay:ANNotation:FREQuency	368
:DISPlay:ANNotation[:ALL]	368
:DISPlay:DIALog:CLOSE	368
:DISPlay:DIALog:ID	369
:DISPlay:DIALog:OPEN	369
:DISPlay:PSAVe:HOLDoff	369
:DISPlay:PSAVe[:STATe]	370
:DISPlay[:WINDow][:POWer]:SWEep:BACKground:COLor	396
:DISPlay[:WINDow][:POWer]:SWEep:GRID:STATe	396
:FORMat:BORDER	370
:FORMat:SREGister	371
:FORMat[:DATA]	371
:HCOPY:DATA?	372
:HCOPY:DEVIce	372
:HCOPY:DEVIce:LANGuage	373
:HCOPY:FILE[:NAME]	373
:HCOPY:FILE[:NAME]:AUTO:DIRectory	374
:HCOPY:FILE[:NAME]:AUTO:DIRectory:CLEar	374
:HCOPY:FILE[:NAME]:AUTO:FILE?	375
:HCOPY:FILE[:NAME]:AUTO:STATe	378
:HCOPY:FILE[:NAME]:AUTO?	374
:HCOPY:FILE[:NAME]:AUTO[:FILE]:DAY:STATe	375
:HCOPY:FILE[:NAME]:AUTO[:FILE]:DAY?	375
:HCOPY:FILE[:NAME]:AUTO[:FILE]:MONTH:STATe	376
:HCOPY:FILE[:NAME]:AUTO[:FILE]:MONTH?	376
:HCOPY:FILE[:NAME]:AUTO[:FILE]:NUMBER?	376
:HCOPY:FILE[:NAME]:AUTO[:FILE]:PREFix	377
:HCOPY:FILE[:NAME]:AUTO[:FILE]:PREFix:STATe	377
:HCOPY:FILE[:NAME]:AUTO[:FILE]:YEAR:STATe	377
:HCOPY:FILE[:NAME]:AUTO[:FILE]:YEAR?	377
:HCOPY:IMAGe:FORMat	378
:HCOPY:IMAGe:SIZE	378
:HCOPY[:EXECute]	373
:INITiate<ch>[:POWer]:CONTInuous	397
:KBOARD:LANGuage	379
:KBOARD:LAYout?	379
:MMEMory:CATalog:LENGth?	383
:MMEMory:CATalog?	382
:MMEMory:CDIRectory	383
:MMEMory:COPY	384
:MMEMory:DATA	384
:MMEMory:DCATalog:LENGth?	385
:MMEMory:DCATalog?	385

:MMEMory:DELeTe.....	385
:MMEMory:LOAD:STATe.....	386
:MMEMory:MDIRectory.....	386
:MMEMory:MOVE.....	386
:MMEMory:MSIS.....	387
:MMEMory:RDIRectory.....	387
:MMEMory:STORe:STATe.....	387
:OUTPut<hw>:AFIXed:RANGe:LOWer?.....	388
:OUTPut<hw>:AFIXed:RANGe:UPPER?.....	388
:OUTPut<hw>:AMODE.....	389
:OUTPut<hw>:IMPedance?.....	389
:OUTPut<hw>:PROTection:CLear.....	390
:OUTPut<hw>:PROTection:TRIPped?.....	390
:OUTPut<hw>[:STATe].....	390
:OUTPut<hw>[:STATe]:PON.....	390
:READ<ch>[:POWer]?.....	397
:SENSe<ch>[:POWer]:SWEep:FREQuency[:SENSor]:OFFSet.....	408
:SENSe<ch>[:POWer]:SWEep:FREQuency[:SENSor]:OFFSet:STATe.....	408
:SENSe<ch>[:POWer]:SWEep:FREQuency[:SENSor]:SRANge:START.....	409
:SENSe<ch>[:POWer]:SWEep:FREQuency[:SENSor]:SRANge:STOP.....	409
:SENSe<ch>[:POWer]:SWEep:FREQuency[:SENSor]:SRANge[:STATe].....	409
:SENSe<ch>[:POWer]:SWEep:POWer[:SENSor]:OFFSet.....	423
:SENSe<ch>[:POWer]:SWEep:POWer[:SENSor]:OFFSet:STATe.....	424
:SENSe<ch>[:POWer]:SWEep:TIME[:SENSor]:OFFSet.....	424
:SENSe<ch>[:POWer]:SWEep:TIME[:SENSor]:OFFSet:STATe.....	425
:SENSe<ch>[:POWer]:SWEep:TIME[:SENSor]:PULSe:STATe.....	425
:SENSe<ch>[:POWer]:SWEep:TIME[:SENSor]:PULSe:THReshold:POWer:HREFerence.....	426
:SENSe<ch>[:POWer]:SWEep:TIME[:SENSor]:PULSe:THReshold:POWer:LREFerence.....	427
:SENSe<ch>[:POWer]:SWEep:TIME[:SENSor]:PULSe:THReshold:POWer:REFerence.....	426
:SENSe<ch>[:POWer]:SWEep:TIME[:SENSor]:TRIGger:SLOPe.....	434
:SENSe[:POWer]:SWEep:FREQuency:REFerence:DATA:COPIY.....	407
:SENSe[:POWer]:SWEep:FREQuency:REFerence:DATA:POINts?.....	407
:SENSe[:POWer]:SWEep:FREQuency:REFerence:DATA:XVALues.....	407
:SENSe[:POWer]:SWEep:FREQuency:REFerence:DATA:YVALues.....	407
:SENSe[:POWer]:SWEep:FREQuency:RMODE.....	408
:SENSe[:POWer]:SWEep:FREQuency:SPACing[:MODE].....	410
:SENSe[:POWer]:SWEep:FREQuency:START.....	410
:SENSe[:POWer]:SWEep:FREQuency:STEPs.....	410
:SENSe[:POWer]:SWEep:FREQuency:STOP.....	411
:SENSe[:POWer]:SWEep:FREQuency:TIMing[:MODE].....	411
:SENSe[:POWer]:SWEep:FREQuency:YSCale:AUTO.....	411
:SENSe[:POWer]:SWEep:FREQuency:YSCale:AUTO:RESet.....	412
:SENSe[:POWer]:SWEep:FREQuency:YSCale:MAXimum.....	412
:SENSe[:POWer]:SWEep:FREQuency:YSCale:MINimum.....	413
:SENSe[:POWer]:SWEep:INITiate.....	422
:SENSe[:POWer]:SWEep:POWer:REFerence:DATA:COPIY.....	422
:SENSe[:POWer]:SWEep:POWer:REFerence:DATA:POINts?.....	422
:SENSe[:POWer]:SWEep:POWer:REFerence:DATA:XVALues.....	422

:SENSe[:POWer]:SWEep:POWer:REFerence:DATA:YVALues.....	423
:SENSe[:POWer]:SWEep:TIME:AVERAge[:COUNT].....	431
:SENSe[:POWer]:SWEep:TIME:REFerence:DATA:COPI.....	431
:SENSe[:POWer]:SWEep:TIME:REFerence:DATA:POINts?.....	431
:SENSe[:POWer]:SWEep:TIME:REFerence:DATA:XVALues.....	431
:SENSe[:POWer]:SWEep:TIME:REFerence:DATA:YVALues.....	432
:SENSe[:POWer]:SWEep:TIME:TEVents.....	435
:SOURce<hw>:PRESet.....	359
:SYSTem:BEEPer:STATe.....	620
:SYSTem:COMMunicate:GPIB:LTERminator.....	620
:SYSTem:COMMunicate:GPIB:RESourcE?.....	624
:SYSTem:COMMunicate:GPIB[:SELf]:ADDReSS.....	621
:SYSTem:COMMunicate:HISLip:RESourcE.....	621
:SYSTem:COMMunicate:NETWork:IPADdress.....	623
:SYSTem:COMMunicate:NETWork:IPADdress:MODE.....	622
:SYSTem:COMMunicate:NETWork:RESourcE.....	624
:SYSTem:COMMunicate:NETWork[:COMMOn]:DOMain.....	621
:SYSTem:COMMunicate:NETWork[:COMMOn]:HOSTname.....	622
:SYSTem:COMMunicate:NETWork[:COMMOn]:WORKgrouP.....	622
:SYSTem:COMMunicate:NETWork[:IPADdress]:GATeway.....	623
:SYSTem:COMMunicate:NETWork[:IPADdress]:SUBNet:MASK.....	623
:SYSTem:COMMunicate:SERial:BAUD.....	625
:SYSTem:COMMunicate:SERial:PARity.....	625
:SYSTem:COMMunicate:SERial:RESourcE?.....	624
:SYSTem:COMMunicate:SERial:SBITs.....	625
:SYSTem:COMMunicate:SOCKet:RESourcE?.....	625
:SYSTem:COMMunicate:USB:RESourcE?.....	624
:SYSTem:DATE.....	626
:SYSTem:DISPlay:UPDate.....	626
:SYSTem:DLOCK.....	626
:SYSTem:FPReset.....	360
:SYSTem:IDENtification.....	629
:SYSTem:IRESpOse.....	629
:SYSTem:KLOCK.....	629
:SYSTem:LANGuage.....	630
:SYSTem:ORESpOse.....	630
:SYSTem:PROTect<ch>[:STATe].....	630
:SYSTem:STARtup:COMPLete?.....	631
:SYSTem:TIME.....	632
:TEST<hw>:ALL:RESult?.....	633
:TEST<hw>:ALL:STARt.....	633
:TEST<hw>:DIRect.....	633
:TRACe<ch>[:POWer]:SWEep:MEASurement:POWer:AVERAge:DISPlay:ANNotation[:STATe].....	445
:TRACe<ch>[:POWer]:SWEep:MEASurement:POWer:HREFerence:DISPlay:ANNotation[:STATe].....	445
:TRACe<ch>[:POWer]:SWEep:MEASurement:POWer:LREFerence:DISPlay:ANNotation[:STATe].....	445
:TRACe<ch>[:POWer]:SWEep:MEASurement:POWer:MAXimum:DISPlay:ANNotation[:STATe].....	445
:TRACe<ch>[:POWer]:SWEep:MEASurement:POWer:MINimum:DISPlay:ANNotation[:STATe].....	445
:TRACe<ch>[:POWer]:SWEep:MEASurement:POWer:PULSe:BASE:DISPlay:ANNotation[:STATe].....	445

:TRACE<ch>[:POWer]:SWEep:MEASurement:POWer:PULSe:TOP:DISPlay:ANNotation[:STATe].....	445
:TRACE<ch>[:POWer]:SWEep:MEASurement:POWer:REFerence:DISPlay:ANNotation[:STATe].....	445
:TRACE<ch>[:POWer]:SWEep:MEASurement:PULSe:DCYClE:DISPlay:ANNotation[:STATe].....	445
:TRACE<ch>[:POWer]:SWEep:MEASurement:PULSe:DURation:DISPlay:ANNotation[:STATe].....	445
:TRACE<ch>[:POWer]:SWEep:MEASurement:PULSe:PERiod:DISPlay:ANNotation[:STATe].....	445
:TRACE<ch>[:POWer]:SWEep:MEASurement:PULSe:SEPARation:DISPlay:ANNotation[:STATe].....	445
:TRACE<ch>[:POWer]:SWEep:MEASurement:TRANSition:NEGative:DURation:DISPlay: ANNotation[:STATe].....	445
:TRACE<ch>[:POWer]:SWEep:MEASurement:TRANSition:NEGative:OCCurrence:DISPlay: ANNotation[:STATe].....	445
:TRACE<ch>[:POWer]:SWEep:MEASurement:TRANSition:NEGative:OVERshoot:DISPlay: ANNotation[:STATe].....	445
:TRACE<ch>[:POWer]:SWEep:MEASurement:TRANSition:POSitive:DURation:DISPlay: ANNotation[:STATe].....	445
:TRACE<ch>[:POWer]:SWEep:MEASurement:TRANSition:POSitive:OCCurrence:DISPlay: ANNotation[:STATe].....	445
:TRACE<ch>[:POWer]:SWEep:MEASurement:TRANSition:POSitive:OVERshoot:DISPlay: ANNotation[:STATe].....	445
:TRACe<ch>[:POWer]:SWEep:COLor.....	440
:TRACe<ch>[:POWer]:SWEep:COPI.....	440
:TRACe<ch>[:POWer]:SWEep:DATA:POINts?.....	440
:TRACe<ch>[:POWer]:SWEep:DATA:XVALues?.....	441
:TRACe<ch>[:POWer]:SWEep:DATA:YVALues?.....	441
:TRACe<ch>[:POWer]:SWEep:FEED.....	441
:TRACe<ch>[:POWer]:SWEep:MEASurement:POWer:AVERage?.....	443
:TRACe<ch>[:POWer]:SWEep:MEASurement:POWer:HREFerence?.....	443
:TRACe<ch>[:POWer]:SWEep:MEASurement:POWer:LREFerence?.....	443
:TRACe<ch>[:POWer]:SWEep:MEASurement:POWer:MAXimum?.....	443
:TRACe<ch>[:POWer]:SWEep:MEASurement:POWer:MINimum?.....	443
:TRACe<ch>[:POWer]:SWEep:MEASurement:POWer:PULSe:BASE?.....	443
:TRACe<ch>[:POWer]:SWEep:MEASurement:POWer:PULSe:TOP?.....	443
:TRACe<ch>[:POWer]:SWEep:MEASurement:POWer:REFerence?.....	443
:TRACe<ch>[:POWer]:SWEep:MEASurement:PULSe:ALL:DISPlay:ANNotation[:STATe].....	444
:TRACe<ch>[:POWer]:SWEep:MEASurement:PULSe:DCYClE?.....	443
:TRACe<ch>[:POWer]:SWEep:MEASurement:PULSe:DURation?.....	443
:TRACe<ch>[:POWer]:SWEep:MEASurement:PULSe:PERiod?.....	443
:TRACe<ch>[:POWer]:SWEep:MEASurement:PULSe:SEPARation?.....	443
:TRACe<ch>[:POWer]:SWEep:MEASurement:PULSe:STATe?.....	443
:TRACe<ch>[:POWer]:SWEep:MEASurement:TRANSition:NEGative:DURation?.....	443
:TRACe<ch>[:POWer]:SWEep:MEASurement:TRANSition:NEGative:OCCurrence?.....	443
:TRACe<ch>[:POWer]:SWEep:MEASurement:TRANSition:NEGative:OVERshoot?.....	443
:TRACe<ch>[:POWer]:SWEep:MEASurement:TRANSition:POSitive:DURation?.....	443
:TRACe<ch>[:POWer]:SWEep:MEASurement:TRANSition:POSitive:OCCurrence?.....	443
:TRACe<ch>[:POWer]:SWEep:MEASurement:TRANSition:POSitive:OVERshoot?.....	443
:TRACe<ch>[:POWer]:SWEep:PULSe:THReshold:BASE?.....	446
:TRACe<ch>[:POWer]:SWEep:PULSe:THReshold:POWer:HREFerence?.....	446
:TRACe<ch>[:POWer]:SWEep:PULSe:THReshold:POWer:LREFerence?.....	447
:TRACe<ch>[:POWer]:SWEep:PULSe:THReshold:POWer:REFerence?.....	447

:TRACe<ch>[:POWer]:SWEep:STATe.....	447
:TRACe[:POWer]:SWEep:MEASurement:FULLscreen:DISPlay:ANNOtation[:STATe].....	442
:TRACe[:POWer]:SWEep:MEASurement:GATE:DISPlay:ANNOtation[:STATe].....	442
:TRACe[:POWer]:SWEep:MEASurement:MARKer:DISPlay:ANNOtation[:STATe].....	443
:TRACe[:POWer]:SWEep:MEASurement:PULSe:DISPlay:ANNOtation[:STATe].....	444
:TRACe[:POWer]:SWEep:MEASurement:STANdard:DISPlay:ANNOtation[:STATe].....	444
:TRIGger<hw>:FSWeep:SOURce.....	635
:TRIGger<hw>:FSWeep[:IMMediate].....	635
:TRIGger<hw>:LFFSweep:SOURce.....	634
:TRIGger<hw>:PSWeep:SOURce.....	637
:TRIGger<hw>:PSWeep[:IMMediate].....	636
:TRIGger<hw>[:SWEep]:SOURce.....	638
:TRIGger<hw>[:SWEep][:IMMediate].....	637
:UNIT:ANGLE.....	639
:UNIT:POWer.....	639
SENSe<ch>:UNIT[:POWer].....	438
SENSe<ch>[:POWer]:CORRection:SPDeVice:STATe.....	400
SENSe<ch>[:POWer]:DISPlay:PERManent:PRiority.....	401
SENSe<ch>[:POWer]:DISPlay:PERManent:STATe.....	401
SENSe<ch>[:POWer]:FILTer:LENGth:AUTO?.....	401
SENSe<ch>[:POWer]:FILTer:LENGth[:USER].....	402
SENSe<ch>[:POWer]:FILTer:NSRatio.....	402
SENSe<ch>[:POWer]:FILTer:NSRatio:MTIME.....	402
SENSe<ch>[:POWer]:FILTer:SONCe.....	403
SENSe<ch>[:POWer]:FILTer:TYPE.....	403
SENSe<ch>[:POWer]:FREQuency.....	404
SENSe<ch>[:POWer]:OFFSet.....	404
SENSe<ch>[:POWer]:OFFSet:STATe.....	405
SENSe<ch>[:POWer]:SNUMber?.....	405
SENSe<ch>[:POWer]:SOURce.....	405
SENSe<ch>[:POWer]:STATus[:DEVice]?.....	406
SENSe<ch>[:POWer]:SVERsion?.....	406
SENSe<ch>[:POWer]:SWEep:POWer[:SENSor]:SFRequency.....	424
SENSe<ch>[:POWer]:SWEep:POWer[:SENSor]:SFRequency:STATe.....	424
SENSe<ch>[:POWer]:SWEep:TIME[:SENSor]:PULSe:THReshold:BASE.....	425
SENSe<ch>[:POWer]:SWEep:TIME[:SENSor]:SFRequency.....	432
SENSe<ch>[:POWer]:SWEep:TIME[:SENSor]:SFRequency:STATe.....	432
SENSe<ch>[:POWer]:SWEep:TIME[:SENSor]:TRIGger:AUTO.....	432
SENSe<ch>[:POWer]:SWEep:TIME[:SENSor]:TRIGger:DTIME.....	433
SENSe<ch>[:POWer]:SWEep:TIME[:SENSor]:TRIGger:HYSTeresis.....	433
SENSe<ch>[:POWer]:SWEep:TIME[:SENSor]:TRIGger:LEVel.....	433
SENSe<ch>[:POWer]:SWEep:TIME[:SENSor]:TRIGger:SOURce.....	434
SENSe<ch>[:POWer]:TYPE?.....	437
SENSe<ch>[:POWer]:ZERO.....	438
SENSe[:POWer]:SWEep:ABORT.....	406
SENSe[:POWer]:SWEep:HCOPY:DATA?.....	413
SENSe[:POWer]:SWEep:HCOPY:DEVice.....	414
SENSe[:POWer]:SWEep:HCOPY:DEVice:LANGUage.....	415

SENSe[:POWer]:SWEep:HCOPy:DEVIce:LANGUage:CSV:DPOint.....	415
SENSe[:POWer]:SWEep:HCOPy:DEVIce:LANGUage:CSV:HEADer.....	415
SENSe[:POWer]:SWEep:HCOPy:DEVIce:LANGUage:CSV:ORientation.....	416
SENSe[:POWer]:SWEep:HCOPy:DEVIce:LANGUage:CSV[:COLumn]:SEParator.....	416
SENSe[:POWer]:SWEep:HCOPy:DEVIce:SIZE.....	416
SENSe[:POWer]:SWEep:HCOPy:FILE[:NAME].....	417
SENSe[:POWer]:SWEep:HCOPy:FILE[:NAME]:AUTO:DIRectory.....	418
SENSe[:POWer]:SWEep:HCOPy:FILE[:NAME]:AUTO:DIRectory:CLEar.....	418
SENSe[:POWer]:SWEep:HCOPy:FILE[:NAME]:AUTO:FILE?.....	418
SENSe[:POWer]:SWEep:HCOPy:FILE[:NAME]:AUTO:STATe.....	421
SENSe[:POWer]:SWEep:HCOPy:FILE[:NAME]:AUTO[:FILE]:DAY:STATe.....	419
SENSe[:POWer]:SWEep:HCOPy:FILE[:NAME]:AUTO[:FILE]:DAY?.....	419
SENSe[:POWer]:SWEep:HCOPy:FILE[:NAME]:AUTO[:FILE]:MONTH:STATe.....	420
SENSe[:POWer]:SWEep:HCOPy:FILE[:NAME]:AUTO[:FILE]:MONTH?.....	419
SENSe[:POWer]:SWEep:HCOPy:FILE[:NAME]:AUTO[:FILE]:NUMBer?.....	420
SENSe[:POWer]:SWEep:HCOPy:FILE[:NAME]:AUTO[:FILE]:PREFix.....	420
SENSe[:POWer]:SWEep:HCOPy:FILE[:NAME]:AUTO[:FILE]:PREFix:STATe.....	420
SENSe[:POWer]:SWEep:HCOPy:FILE[:NAME]:AUTO[:FILE]:YEAR:STATe.....	421
SENSe[:POWer]:SWEep:HCOPy:FILE[:NAME]:AUTO[:FILE]:YEAR?.....	421
SENSe[:POWer]:SWEep:HCOPy[:EXECute].....	417
SENSe[:POWer]:SWEep:MODE.....	422
SENSe[:POWer]:SWEep:POWer:RMODE.....	423
SENSe[:POWer]:SWEep:POWer:SPACing[:MODE].....	427
SENSe[:POWer]:SWEep:POWer:START.....	427
SENSe[:POWer]:SWEep:POWer:STEPS.....	428
SENSe[:POWer]:SWEep:POWer:STOP.....	428
SENSe[:POWer]:SWEep:POWer:TIMing[:MODE].....	428
SENSe[:POWer]:SWEep:POWer:YSCale:AUTO.....	428
SENSe[:POWer]:SWEep:POWer:YSCale:AUTO:RESet.....	429
SENSe[:POWer]:SWEep:POWer:YSCale:MAXimum.....	429
SENSe[:POWer]:SWEep:POWer:YSCale:MINimum.....	430
SENSe[:POWer]:SWEep:RMODE.....	430
SENSe[:POWer]:SWEep:TIME:RMODE.....	430
SENSe[:POWer]:SWEep:TIME:SPACing[:MODE]?.....	434
SENSe[:POWer]:SWEep:TIME:START.....	434
SENSe[:POWer]:SWEep:TIME:STEPS.....	435
SENSe[:POWer]:SWEep:TIME:STOP.....	435
SENSe[:POWer]:SWEep:TIME:YSCale:AUTO.....	436
SENSe[:POWer]:SWEep:TIME:YSCale:AUTO:RESet.....	436
SENSe[:POWer]:SWEep:TIME:YSCale:MAXimum.....	437
SENSe[:POWer]:SWEep:TIME:YSCale:MINimum.....	437
STATus:OPERation:CONDition?.....	615
STATus:OPERation:ENABLE.....	616
STATus:OPERation:NTRansition.....	616
STATus:OPERation:PTRansition.....	617
STATus:OPERation[:EVENT]?.....	616
STATus:PRESet.....	617
STATus:QUESTionable:CONDition?.....	617

STATus:QUESTionable:ENABLE.....	618
STATus:QUESTionable:NTRansition.....	618
STATus:QUESTionable:PTRansition.....	618
STATus:QUESTionable[:EVENT]?	618
STATus:QUEue[:NEXT]?	619
SYSTem:ERRor:ALL?	627
SYSTem:ERRor:CODE:ALL?	627
SYSTem:ERRor:CODE[:NEXT]?	627
SYSTem:ERRor:COUNT?	628
SYSTem:ERRor[:NEXT]?	628
SYSTem:PRESet.....	359
SYSTem:SERRor?	631
SYSTem:VERSIon?	632
TRIGger0[:SWEep]:SOURce.....	634
[:SOURce<hw>]:AM:EXTernal:COUPling.....	455
[:SOURce<hw>]:AM:INTernal:SOURce.....	455
[:SOURce<hw>]:AM:INTernal<ch>:DEPTh.....	455
[:SOURce<hw>]:AM:SENSitivity?	456
[:SOURce<hw>]:AM:SOURce.....	456
[:SOURce<hw>]:AM:STATe.....	457
[:SOURce<hw>]:AM[:DEPTh].....	454
[:SOURce<hw>]:CHIRp:BANDwidth.....	457
[:SOURce<hw>]:CHIRp:COMPression:RATio?	458
[:SOURce<hw>]:CHIRp:DIRection.....	458
[:SOURce<hw>]:CHIRp:PULSe:PERiod.....	459
[:SOURce<hw>]:CHIRp:PULSe:WIDTh.....	459
[:SOURce<hw>]:CHIRp:STATe.....	459
[:SOURce<hw>]:CHIRp:TRIGger:EXTernal:GATE:POLarity.....	460
[:SOURce<hw>]:CHIRp:TRIGger:EXTernal:IMPedance.....	460
[:SOURce<hw>]:CHIRp:TRIGger:EXTernal:SLOPe.....	460
[:SOURce<hw>]:CHIRp:TRIGger:MODE.....	461
[:SOURce<hw>]:CORRection:CSET:DATA:FREQuency.....	463
[:SOURce<hw>]:CORRection:CSET:DATA:FREQuency:POINts?	463
[:SOURce<hw>]:CORRection:CSET:DATA:POWer.....	463
[:SOURce<hw>]:CORRection:CSET:DATA:POWer:POINts?	464
[:SOURce<hw>]:CORRection:CSET:DATA[:SENSor<ch>][:POWer]:SONCe.....	464
[:SOURce<hw>]:CORRection:CSET[:SELEct].....	469
[:SOURce<hw>]:CORRection:DEXChange:AFILe:CATalog?	465
[:SOURce<hw>]:CORRection:DEXChange:AFILe:EXTension.....	465
[:SOURce<hw>]:CORRection:DEXChange:AFILe:SELEct.....	466
[:SOURce<hw>]:CORRection:DEXChange:AFILe:SEParator:COLumn.....	466
[:SOURce<hw>]:CORRection:DEXChange:AFILe:SEParator:DECimal.....	467
[:SOURce<hw>]:CORRection:DEXChange:EXECute.....	467
[:SOURce<hw>]:CORRection:DEXChange:MODE.....	468
[:SOURce<hw>]:CORRection:DEXChange:SELEct.....	468
[:SOURce<hw>]:CORRection:VALue?.....	470
[:SOURce<hw>]:CORRection[:STATe].....	469
[:SOURce<hw>]:FM:EXTernal:COUPling.....	496

[:SOURce<hw>]:FM:EXTernal:DEViation.....	497
[:SOURce<hw>]:FM:EXTernal:DIGital:BFORmat.....	497
[:SOURce<hw>]:FM:INTernal:SOURce.....	498
[:SOURce<hw>]:FM:INTernal<ch>:DEViation.....	498
[:SOURce<hw>]:FM:MODE.....	498
[:SOURce<hw>]:FM:SENSitivity?.....	499
[:SOURce<hw>]:FM:SOURce.....	499
[:SOURce<hw>]:FM:STATe.....	500
[:SOURce<hw>]:FM[:DEViation].....	496
[:SOURce<hw>]:FREQuency:CENTer.....	501
[:SOURce<hw>]:FREQuency:MANual.....	502
[:SOURce<hw>]:FREQuency:MODE.....	503
[:SOURce<hw>]:FREQuency:MULTiplier.....	504
[:SOURce<hw>]:FREQuency:OFFSet.....	504
[:SOURce<hw>]:FREQuency:PHASe:CONTinuous:HIGH?.....	504
[:SOURce<hw>]:FREQuency:PHASe:CONTinuous:LOW?.....	505
[:SOURce<hw>]:FREQuency:PHASe:CONTinuous:MODE.....	505
[:SOURce<hw>]:FREQuency:PHASe:CONTinuous:STATe.....	506
[:SOURce<hw>]:FREQuency:SPAN.....	506
[:SOURce<hw>]:FREQuency:STARt.....	507
[:SOURce<hw>]:FREQuency:STEP:MODE.....	509
[:SOURce<hw>]:FREQuency:STEP[:INCRement].....	508
[:SOURce<hw>]:FREQuency:STOP.....	508
[:SOURce<hw>]:FREQuency[:CW FIXed].....	501
[:SOURce<hw>]:FREQuency[:CW FIXed]:RCL.....	502
[:SOURce<hw>]:INPut:MODext:IMPedance.....	525
[:SOURce<hw>]:LIST:CATalog?.....	538
[:SOURce<hw>]:LIST:DELete.....	539
[:SOURce<hw>]:LIST:DELete:ALL.....	539
[:SOURce<hw>]:LIST:DEXChange:AFILe:CATalog?.....	540
[:SOURce<hw>]:LIST:DEXChange:AFILe:EXTension.....	540
[:SOURce<hw>]:LIST:DEXChange:AFILe:SELect.....	541
[:SOURce<hw>]:LIST:DEXChange:AFILe:SEParator:COLumn.....	541
[:SOURce<hw>]:LIST:DEXChange:AFILe:SEParator:DECimal.....	542
[:SOURce<hw>]:LIST:DEXChange:EXECute.....	542
[:SOURce<hw>]:LIST:DEXChange:MODE.....	543
[:SOURce<hw>]:LIST:DEXChange:SELect.....	543
[:SOURce<hw>]:LIST:DWELL.....	544
[:SOURce<hw>]:LIST:FREE?.....	544
[:SOURce<hw>]:LIST:FREQuency.....	544
[:SOURce<hw>]:LIST:FREQuency:POINts?.....	545
[:SOURce<hw>]:LIST:INDeX.....	545
[:SOURce<hw>]:LIST:INDeX:STARt.....	546
[:SOURce<hw>]:LIST:INDeX:STOP.....	546
[:SOURce<hw>]:LIST:LEARn.....	547
[:SOURce<hw>]:LIST:MODE.....	547
[:SOURce<hw>]:LIST:POWer.....	548
[:SOURce<hw>]:LIST:POWer:AMODE.....	548

[[:SOURce<hw>]:LIST:POWer:POINts?.....	549
[[:SOURce<hw>]:LIST:RESet.....	549
[[:SOURce<hw>]:LIST:SElect.....	549
[[:SOURce<hw>]:LIST:TRIGger:EXECute.....	549
[[:SOURce<hw>]:LIST:TRIGger:SOURce.....	550
[[:SOURce<hw>]:MODulation[:ALL]:STATe.....	557
[[:SOURce<hw>]:NOISe:BWIDth.....	558
[[:SOURce<hw>]:NOISe:BWIDth:STATe.....	558
[[:SOURce<hw>]:NOISe:DISTRibution.....	559
[[:SOURce<hw>]:NOISe:LEVel:RELative?.....	559
[[:SOURce<hw>]:NOISe:LEVel[:ABSolute]?.....	559
[[:SOURce<hw>]:PGEN:STATe.....	560
[[:SOURce<hw>]:PHASe.....	560
[[:SOURce<hw>]:PHASe:REFerence.....	561
[[:SOURce<hw>]:PM:EXTernal:COUPling.....	562
[[:SOURce<hw>]:PM:EXTernal:DEVIation.....	562
[[:SOURce<hw>]:PM:EXTernal:DIgital:BFORmat.....	563
[[:SOURce<hw>]:PM:INTernal:SOURce.....	563
[[:SOURce<hw>]:PM:INTernal<ch>:DEVIation.....	563
[[:SOURce<hw>]:PM:MODE.....	564
[[:SOURce<hw>]:PM:SENSitivity?.....	564
[[:SOURce<hw>]:PM:SOURce.....	565
[[:SOURce<hw>]:PM:STATe.....	565
[[:SOURce<hw>]:PM[:DEVIation].....	561
[[:SOURce<hw>]:POWer:ALC:OMODE.....	566
[[:SOURce<hw>]:POWer:ALC:SONCe.....	567
[[:SOURce<hw>]:POWer:ALC[:STATe].....	567
[[:SOURce<hw>]:POWer:ATTenuation:RFOff:MODE.....	567
[[:SOURce<hw>]:POWer:LIMit[:AMPLitude].....	570
[[:SOURce<hw>]:POWer:MANual.....	570
[[:SOURce<hw>]:POWer:MODE.....	571
[[:SOURce<hw>]:POWer:POWer.....	572
[[:SOURce<hw>]:POWer:SPC:CRANge.....	573
[[:SOURce<hw>]:POWer:SPC:DELay.....	573
[[:SOURce<hw>]:POWer:SPC:PEAK.....	573
[[:SOURce<hw>]:POWer:SPC:SElect.....	574
[[:SOURce<hw>]:POWer:SPC:STATe.....	574
[[:SOURce<hw>]:POWer:SPC:TARGet.....	574
[[:SOURce<hw>]:POWer:STARt.....	574
[[:SOURce<hw>]:POWer:STEP:MODE.....	575
[[:SOURce<hw>]:POWer:STEP[:INCRement].....	575
[[:SOURce<hw>]:POWer:STOP.....	576
[[:SOURce<hw>]:POWer[:LEVel][:IMMediate]:OFFSet.....	569
[[:SOURce<hw>]:POWer[:LEVel][:IMMediate]:RCL.....	569
[[:SOURce<hw>]:POWer[:LEVel][:IMMediate][:AMPLitude].....	568
[[:SOURce<hw>]:PULM:DELay.....	577
[[:SOURce<hw>]:PULM:DOUBle:DELay.....	578
[[:SOURce<hw>]:PULM:DOUBle:STATe.....	578

[:SOURce<hw>]:PULM:DOUBle:WIDTh.....	578
[:SOURce<hw>]:PULM:MODE.....	579
[:SOURce<hw>]:PULM:OUTPut:SYNC[:STATe].....	579
[:SOURce<hw>]:PULM:PERiod.....	579
[:SOURce<hw>]:PULM:POLarity.....	580
[:SOURce<hw>]:PULM:SOURce.....	580
[:SOURce<hw>]:PULM:STATe.....	581
[:SOURce<hw>]:PULM:TRAIIn:CATalog?.....	581
[:SOURce<hw>]:PULM:TRAIIn:DELete.....	582
[:SOURce<hw>]:PULM:TRAIIn:DEXChange:AFILe:CATalog?.....	587
[:SOURce<hw>]:PULM:TRAIIn:DEXChange:AFILe:EXTension.....	588
[:SOURce<hw>]:PULM:TRAIIn:DEXChange:AFILe:SELect.....	588
[:SOURce<hw>]:PULM:TRAIIn:DEXChange:AFILe:SEParator:COLumn.....	589
[:SOURce<hw>]:PULM:TRAIIn:DEXChange:AFILe:SEParator:DECimal.....	589
[:SOURce<hw>]:PULM:TRAIIn:DEXChange:EXECute.....	590
[:SOURce<hw>]:PULM:TRAIIn:DEXChange:MODE.....	590
[:SOURce<hw>]:PULM:TRAIIn:DEXChange:SELect.....	591
[:SOURce<hw>]:PULM:TRAIIn:OFFTTime.....	582
[:SOURce<hw>]:PULM:TRAIIn:OFFTTime:POINts?.....	583
[:SOURce<hw>]:PULM:TRAIIn:ONTime.....	583
[:SOURce<hw>]:PULM:TRAIIn:ONTime:POINts?.....	584
[:SOURce<hw>]:PULM:TRAIIn:REPetition.....	584
[:SOURce<hw>]:PULM:TRAIIn:REPetition:POINts?.....	585
[:SOURce<hw>]:PULM:TRAIIn:SELect.....	585
[:SOURce<hw>]:PULM:TRIGger:EXTernal:GATE:POLarity.....	586
[:SOURce<hw>]:PULM:TRIGger:EXTernal:IMPedance.....	586
[:SOURce<hw>]:PULM:TRIGger:EXTernal:SLOPe.....	586
[:SOURce<hw>]:PULM:TRIGger:MODE.....	587
[:SOURce<hw>]:PULM:WIDTh.....	591
[:SOURce<hw>]:SWEep:POWer:AMODE.....	600
[:SOURce<hw>]:SWEep:POWer:DWELI.....	601
[:SOURce<hw>]:SWEep:POWer:EXECute.....	601
[:SOURce<hw>]:SWEep:POWer:MODE.....	601
[:SOURce<hw>]:SWEep:POWer:POINts.....	602
[:SOURce<hw>]:SWEep:POWer:SHAPE.....	602
[:SOURce<hw>]:SWEep:POWer:SPACing:MODE?.....	603
[:SOURce<hw>]:SWEep:POWer:STEP[:LOGarithmic].....	603
[:SOURce<hw>]:SWEep:RESEt[:ALL].....	604
[:SOURce<hw>]:SWEep[:FREQuency]:DWELI.....	596
[:SOURce<hw>]:SWEep[:FREQuency]:EXECute.....	596
[:SOURce<hw>]:SWEep[:FREQuency]:MODE.....	597
[:SOURce<hw>]:SWEep[:FREQuency]:POINts.....	597
[:SOURce<hw>]:SWEep[:FREQuency]:SHAPE.....	598
[:SOURce<hw>]:SWEep[:FREQuency]:SPACing.....	598
[:SOURce<hw>]:SWEep[:FREQuency]:STEP:LOGarithmic.....	600
[:SOURce<hw>]:SWEep[:FREQuency]:STEP[:LINear].....	599
[:SOURce]:ADF:COMid:CODE.....	449
[:SOURce]:ADF:COMid:DASH.....	450

[[:SOURce]:ADF:COMid:DEPTh.....	450
[[:SOURce]:ADF:COMid:DOT.....	451
[[:SOURce]:ADF:COMid:FREQuency.....	451
[[:SOURce]:ADF:COMid:LETTer.....	451
[[:SOURce]:ADF:COMid:PERiod.....	452
[[:SOURce]:ADF:COMid:SYMBol.....	452
[[:SOURce]:ADF:COMid:TSCHEMA.....	453
[[:SOURce]:ADF:COMid[:STATe].....	453
[[:SOURce]:ADF:STATe.....	454
[[:SOURce]:CORRection:CSET:CATalog?.....	462
[[:SOURce]:CORRection:CSET:DELeTe.....	464
[[:SOURce]:DME:ANALysis:EFFiciency:OK?.....	472
[[:SOURce]:DME:ANALysis:EFFiciency:STATe.....	472
[[:SOURce]:DME:ANALysis:EFFiciency?.....	471
[[:SOURce]:DME:ANALysis:GATE:COUNT.....	472
[[:SOURce]:DME:ANALysis:GATE:EDELay.....	473
[[:SOURce]:DME:ANALysis:GATE[:LENGth].....	473
[[:SOURce]:DME:ANALysis:NORMAlize?.....	474
[[:SOURce]:DME:ANALysis:POWer:OK?.....	475
[[:SOURce]:DME:ANALysis:POWer:STATe.....	475
[[:SOURce]:DME:ANALysis:POWer?.....	474
[[:SOURce]:DME:ANALysis:PRRate:OK?.....	476
[[:SOURce]:DME:ANALysis:PRRate:STATe.....	476
[[:SOURce]:DME:ANALysis:PRRate?.....	475
[[:SOURce]:DME:ANALysis:STATe.....	477
[[:SOURce]:DME:ANALysis:TIME:OK?.....	478
[[:SOURce]:DME:ANALysis:TIME:STATe.....	478
[[:SOURce]:DME:ANALysis:TIME?.....	477
[[:SOURce]:DME:ANALysis:TRIGger:SEARch?.....	478
[[:SOURce]:DME:CSUffix.....	479
[[:SOURce]:DME:EFFiciency.....	480
[[:SOURce]:DME:FALL.....	481
[[:SOURce]:DME:ICAO:CHANnel.....	479
[[:SOURce]:DME:ID:CODE.....	481
[[:SOURce]:DME:ID:DASH.....	481
[[:SOURce]:DME:ID:DOT.....	482
[[:SOURce]:DME:ID:LETTer.....	483
[[:SOURce]:DME:ID:PERiod.....	483
[[:SOURce]:DME:ID:PRESet.....	484
[[:SOURce]:DME:ID:RATE.....	484
[[:SOURce]:DME:ID:SYMBol.....	485
[[:SOURce]:DME:ID:TSCHEMA.....	485
[[:SOURce]:DME:ID[:STATe].....	484
[[:SOURce]:DME:LOWemission.....	486
[[:SOURce]:DME:MODE.....	486
[[:SOURce]:DME:PPS.....	487
[[:SOURce]:DME:PRESet.....	487
[[:SOURce]:DME:RATE.....	487

[:SOURce]:DME:RDISTance.....	488
[:SOURce]:DME:RISE.....	488
[:SOURce]:DME:SHAPE.....	489
[:SOURce]:DME:SINGLE.....	489
[:SOURce]:DME:SQUitter.....	489
[:SOURce]:DME:STATe.....	490
[:SOURce]:DME:TACan:DEPTh.....	490
[:SOURce]:DME:TACan:INTernal<ch>:DEPTh.....	491
[:SOURce]:DME:TACan:PHASe.....	491
[:SOURce]:DME:TACan:STATe.....	492
[:SOURce]:DME:TACan<ch>:FREQuency.....	491
[:SOURce]:DME:TRIGger.....	492
[:SOURce]:DME:TRIGger:DELay.....	493
[:SOURce]:DME:TRIGger:DELay:NORMalize?.....	494
[:SOURce]:DME:TRIGger:GPOLarity.....	494
[:SOURce]:DME:TRIGger:IMPedance.....	494
[:SOURce]:DME:TRIGger:SLOPe.....	495
[:SOURce]:DME:WIDTh.....	495
[:SOURce]:ILS:GS GSLope:STATe.....	524
[:SOURce]:ILS:LOCalizer:COMid:CODE.....	510
[:SOURce]:ILS:LOCalizer:COMid:DASH.....	511
[:SOURce]:ILS:LOCalizer:COMid:DEPTh.....	511
[:SOURce]:ILS:LOCalizer:COMid:DOT.....	512
[:SOURce]:ILS:LOCalizer:COMid:FREQuency.....	512
[:SOURce]:ILS:LOCalizer:COMid:LETTer.....	512
[:SOURce]:ILS:LOCalizer:COMid:PERiod.....	513
[:SOURce]:ILS:LOCalizer:COMid:SYMBOL.....	514
[:SOURce]:ILS:LOCalizer:COMid:TSCHEMA.....	514
[:SOURce]:ILS:LOCalizer:COMid[:STATe].....	513
[:SOURce]:ILS:LOCalizer:DDM:COUPLing.....	515
[:SOURce]:ILS:LOCalizer:DDM:CURREnt.....	515
[:SOURce]:ILS:LOCalizer:DDM:DIRection.....	516
[:SOURce]:ILS:LOCalizer:DDM:LOGarithmic.....	517
[:SOURce]:ILS:LOCalizer:DDM:PCT.....	517
[:SOURce]:ILS:LOCalizer:DDM:POLarity.....	518
[:SOURce]:ILS:LOCalizer:DDM[:DEPTh].....	515
[:SOURce]:ILS:LOCalizer:FREQuency:STEP.....	518
[:SOURce]:ILS:LOCalizer:ICAO:CHANnel.....	519
[:SOURce]:ILS:LOCalizer:LLOBe[:FREQuency].....	519
[:SOURce]:ILS:LOCalizer:MODE.....	521
[:SOURce]:ILS:LOCalizer:PHASe.....	521
[:SOURce]:ILS:LOCalizer:PRESet.....	522
[:SOURce]:ILS:LOCalizer:RLOBe[:FREQuency].....	522
[:SOURce]:ILS:LOCalizer:SDM.....	523
[:SOURce]:ILS:LOCalizer:SOURce.....	523
[:SOURce]:ILS:LOCalizer:STATe.....	524
[:SOURce]:ILS[:GS GSLope]:DDM:COUPLing.....	515
[:SOURce]:ILS[:GS GSLope]:DDM:CURREnt.....	515

[:SOURce]:ILS[:GS GSLope]:DDM:DIRection.....	516
[:SOURce]:ILS[:GS GSLope]:DDM:LOGarithmic.....	517
[:SOURce]:ILS[:GS GSLope]:DDM:PCT.....	517
[:SOURce]:ILS[:GS GSLope]:DDM:POLarity.....	518
[:SOURce]:ILS[:GS GSLope]:DDM[:DEPT]h.....	515
[:SOURce]:ILS[:GS GSLope]:FREQuency:STEP.....	518
[:SOURce]:ILS[:GS GSLope]:ICAO:CHANnel.....	519
[:SOURce]:ILS[:GS GSLope]:LLOBe[:FREQuency].....	519
[:SOURce]:ILS[:GS GSLope]:MODE.....	520
[:SOURce]:ILS[:GS GSLope]:PHASe.....	521
[:SOURce]:ILS[:GS GSLope]:PRESet.....	522
[:SOURce]:ILS[:GS GSLope]:SDM.....	523
[:SOURce]:ILS[:GS GSLope]:SOURce.....	523
[:SOURce]:ILS[:GS GSLope]:ULOBe[:FREQuency].....	524
[:SOURce]:INPut:TRIGger:SLOPe.....	525
[:SOURce]:LFOutput:FREQuency:MANual.....	527
[:SOURce]:LFOutput:FREQuency:MODE.....	527
[:SOURce]:LFOutput:FREQuency:STARt.....	528
[:SOURce]:LFOutput:FREQuency:STOP.....	529
[:SOURce]:LFOutput:OFFSet.....	529
[:SOURce]:LFOutput:SOURce.....	530
[:SOURce]:LFOutput:SWEep[:FREQuency]:DWELl.....	530
[:SOURce]:LFOutput:SWEep[:FREQuency]:EXECute.....	530
[:SOURce]:LFOutput:SWEep[:FREQuency]:LFSource.....	531
[:SOURce]:LFOutput:SWEep[:FREQuency]:MODE.....	531
[:SOURce]:LFOutput:SWEep[:FREQuency]:POINTs.....	532
[:SOURce]:LFOutput:SWEep[:FREQuency]:SHAPE.....	533
[:SOURce]:LFOutput:SWEep[:FREQuency]:SPACing.....	533
[:SOURce]:LFOutput:SWEep[:FREQuency]:STEP:LOGarithmic.....	534
[:SOURce]:LFOutput:SWEep[:FREQuency]:STEP[:LINear].....	533
[:SOURce]:LFOutput:VOLTagE.....	536
[:SOURce]:LFOutput<ch>:FREQuency.....	526
[:SOURce]:LFOutput<ch>:INTernal:VOLTagE.....	529
[:SOURce]:LFOutput<ch>:SHAPE.....	535
[:SOURce]:LFOutput<ch>:SHAPE:TRAPeZe:FALL.....	535
[:SOURce]:LFOutput<ch>:SHAPE:TRAPeZe:HIGH.....	535
[:SOURce]:LFOutput<ch>:SHAPE:TRAPeZe:LOW.....	536
[:SOURce]:LFOutput<ch>:SHAPE:TRAPeZe:RISE.....	536
[:SOURce]:LFOutput[:STATe].....	530
[:SOURce]:MBEacon:COMid:CODE.....	551
[:SOURce]:MBEacon:COMid:DASH.....	552
[:SOURce]:MBEacon:COMid:DEPT]h.....	552
[:SOURce]:MBEacon:COMid:DOT.....	553
[:SOURce]:MBEacon:COMid:FREQuency.....	553
[:SOURce]:MBEacon:COMid:LETTER.....	553
[:SOURce]:MBEacon:COMid:PERiod.....	554
[:SOURce]:MBEacon:COMid:SYMBOL.....	554
[:SOURce]:MBEacon:COMid:TSCHEMA.....	555

[[:SOURce]:MBEacon:COMid[:STATe].....	555
[[:SOURce]:MBEacon:PRESet.....	556
[[:SOURce]:MBEacon:STATe.....	556
[[:SOURce]:MBEacon[:MARKer]:DEPTH.....	556
[[:SOURce]:MBEacon[:MARKer]:FREQUency.....	557
[[:SOURce]:MBEacon[:MARKer]:PULSed.....	557
[[:SOURce]:ROSCillator:EXTernal:FREQUency.....	592
[[:SOURce]:ROSCillator:EXTernal:RFOFF[:STATe].....	592
[[:SOURce]:ROSCillator:EXTernal:SBANDwidth.....	593
[[:SOURce]:ROSCillator:SOURce.....	594
[[:SOURce]:ROSCillator[:INTernal]:ADJust:VALue.....	594
[[:SOURce]:ROSCillator[:INTernal]:ADJust[:STATe].....	594
[[:SOURce]:VOR:COMid:CODE.....	605
[[:SOURce]:VOR:COMid:DASH.....	605
[[:SOURce]:VOR:COMid:DEPTH.....	606
[[:SOURce]:VOR:COMid:DOT.....	606
[[:SOURce]:VOR:COMid:FREQUency.....	606
[[:SOURce]:VOR:COMid:LETTer.....	607
[[:SOURce]:VOR:COMid:PERiod.....	607
[[:SOURce]:VOR:COMid:SYMBOL.....	608
[[:SOURce]:VOR:COMid:TSCHEMA.....	608
[[:SOURce]:VOR:COMid[:STATe].....	609
[[:SOURce]:VOR:FREQUency:STEP.....	609
[[:SOURce]:VOR:ICAO:CHANnel.....	609
[[:SOURce]:VOR:MODE.....	610
[[:SOURce]:VOR:PRESet.....	611
[[:SOURce]:VOR:REFerence[:DEViation].....	611
[[:SOURce]:VOR:SOURce.....	612
[[:SOURce]:VOR:STATe.....	612
[[:SOURce]:VOR:SUBCarrier:DEPTH.....	613
[[:SOURce]:VOR:SUBCarrier:FREQUency].....	613
[[:SOURce]:VOR:VAR:FREQUency.....	613
[[:SOURce]:VOR:VAR[:DEPTH].....	614
[[:SOURce]:VOR[:BANGLE].....	614
[[:SOURce]:VOR[:BANGLE]:DIRection.....	614

Index

- 50 - Extern reference out of range or disconnected 651
- 140 - This modulation forces other modulations off 651
- 180 - Adjustment failed 651
- 182 - Adjustment data missing 651
- 183 - Adjustment data invalid 652
- 200 - Cannot access hardware 652
- 201 - Hardware revision out of date 652
- 202 - Cannot access the EEPROM 652
- 203 - Invalid EEPROM data 652
- 204 - river initialization failed 652
- 241 - No current list 652
- 242 - Unknown list type specified 652
- 460 - Cannot open file 652
- 461 - Cannot write file 652
- 462 - Cannot read file 652
- 463 - Filename missing 652
- 464 - Invalid filename extension 652
- 465 - File contains invalid data 652
- >L 323
- &LLO 323
- &NREN 323
- *IDN? 629
- *OPC 343
- *OPC? 343
- *RST 352
- *WAI 343
- /var directory 379
- A**
- Abort button 69
- Abort calculation 69
- Accept
 Security Settings 102
- Access denied 62
- AC supply 23
- ADF modulation 287
- Adjust All 83, 361
- Adjust Clock Synthesis 84, 361
- Adjust DME Pulse Slope 84, 246
- Adjust DME Pulse Slope - Pulse Modulation 361
- Adjust FM Offset 362
- Adjust Level 84, 362
- Adjust LF Gen/Mod Gen 84, 363
- Adjustment Active 126, 594
- Adjustment Data 84, 362
- Adjustment Frequency 126, 594
- Adjustment value - Reference frequency 126, 594
- Adjust Synthesis 83, 362
- Adjust Synthesis Extension 83
- Airplane position 260
- ALC (automatic level control) 132, 566
- ALC Auto 649
- ALC On 132, 649
- ALC S&H 649
- ALC Table 649
- All Trigger Events - Power Sensors 435
- AM
 Depth 216, 454
- Depth1/2 455
- External Coupling 218, 455
- Frequency 526
- internal source 216, 455
- Sensitivity 217, 456
- Source 216, 456
- State 216, 457
- Annotate all
 display 368
- Annotate amplitude
 display 368
- Annotate frequency
 display 368
- Annotation Amplitude 101
- Annotation Frequency 101
- Antenna lobe
 frequency - ILS-GS Modulation 269, 519, 524
- frequency - ILS-LOC Modulation 276, 522
- phase - ILS-GS Modulation 270, 521
- phase - ILS-LOC Modulation 276, 521
- Architecture of the instrument 44
- Arrow keys 19
- ASCII file import/export
 List Mode 202
- Assemblies display 84, 366
- ATN 653
- Attention 653
- Attenuator 389
- Attenuator Mode 129, 389
 List Mode 205
- Sweep 202, 600
- Attenuator Mode - List Mode 548
- Attenuator settings
 RF OFF mode 567
- Attenuator Settings
 Fixed Range (PEP) in 130
- mode 129
- RF OFF Mode 130
- AttFixed 649
- Automatic Naming Hardcopy 378
 Power Analysis 186
- Automatic Naming Hardcopy - Power Analysis 421
- Auto Once
 Power Sensors 149
- Auto Once - Power Sensors 403
- Auto Scale
 Power Analysis 165
- Auto Scale - Power Analysis 411, 428, 436
- Auto Set
 Power Sensors 183
- Avahi
 LAN Services 100
- Average
 Power Analysis 163
- Average - Power Analysis 431
- Avionics systems 213
- B**
- Background color
 Power Analysis 166, 396

Bandwidth		
Chirp modulation	234	
Noise	558	
Bandwidth Limitation	300	
Noise	558	
Baudrate	625	
Baudrate - RS232 Interface	96	
Bearing Angle		
VOR modulation	260	
Binary Offset	222, 227	
Bluetooth Pin	102	
Bluetooth Setup	96	
Boolean parameters	339	
BUSY	648	
C		
Calibration		
remote	354	
Case-sensitivity		
SCPI	335	
Catch range		
NRP-Z level control	137	
NRP-Z power control	573	
Center Freq	194, 501	
CF memory slot	23	
Change Password - Setup	99, 100	
Change to ILS-GS	282	
Change to ILS-LOC - ILS-GS Modulation	272	
Channel Mode - DME modulation	240	
Check Front Panel	90	
Chirp Deviation	234, 457	
Chirp modulation	231	
Bandwidth	234	
Compression ratio	235	
Direction	234	
External impedance	236	
Ext trigger input slope	235	
Gated signal	235	
Gate input polarity	235	
Pulse period	235	
Pulse width	235	
State	233	
Trigger mode	235	
Chirp period	235	
Clear status		
remote	354	
Clock synthesis	48	
Clock Synthesis	363	
Clock synthesis inverted output	311	
Clock synthesis output	311	
Colon	340	
Column Separator Import/Export		
List Mode data	541	
Pulse Train data	310	
Column Separator Import/Export - List Mode data	589	
Column Separator Import/Export - User Correction data	142, 466	
COM/ID Dash Length		
ADF Modulation	290	
ILS-LOC modulation	279	
Marker Beacon modulation	286	
VOR modulation	264	
COM/ID Dash Length - ADF Modulation	450	
COM/ID Dash Length - VOR Modulation	605	
COM/ID Depth		
ADF Modulation	290	
ILS-LOC modulation	279	
Marker Beacon modulation	285	
VOR modulation	263	
COM/ID Depth - ADF Modulation	450	
COM/ID Depth - VOR Modulation	606	
COM/ID Dot length		
ADF Modulation	290	
ILS-LOC modulation	279	
Marker Beacon modulation	286	
VOR modulation	264	
COM/ID Dot length - ADF Modulation	451	
COM/ID Dot length - VOR Modulation	606	
COM/ID Frequency		
ADF Modulation	290	
ILS-LOC modulation	278	
Marker Beacon modulation	285	
VOR modulation	263	
COM/ID Frequency - ADF Modulation	451	
COM/ID Frequency - VOR Modulation	606	
COM/ID Letter Length		
ADF Modulation	291	
ILS-LOC modulation	279	
Marker Beacon modulation	286	
VOR modulation	264	
COM/ID Letter Space - ADF Modulation	451	
COM/ID Letter Space - VOR Modulation	607	
COM/ID Period		
ADF Modulation	290	
ILS-LOC Modulation	278, 513	
Marker Beacon Modulation	285, 554	
VOR Modulation	263, 607	
COM/ID signal		
ADF Modulation	288	
ILS-LOC modulation	277	
Marker Beacon modulation	284	
VOR modulation	262	
COM/ID signal - ADF Modulation	453	
COM/ID signal code		
ADF Modulation	289	
Marker Beacon modulation	284	
VOR modulation	262	
COM/ID signal code - ADF Modulation	449	
COM/ID signal code - VOR Modulation	605	
COM/ID signal - Marker Beacon Modulation	454	
COM/ID signal - VOR Modulation	609	
COM/ID Symbol Space		
ADF Modulation	291	
ILS-LOC modulation	279	
Marker Beacon modulation	286	
VOR modulation	264	
COM/ID Symbol Space - ADF Modulation	452	
COM/ID Symbol Space - VOR Modulation	608	
COM/ID Time Schema		
ADF Modulation	290	
ILS-LOC modulation	279	
Marker Beacon modulation	286	
VOR modulation	263	
COM/ID Time Schema - ADF Modulation	453	
COM/ID Time Schema - VOR Modulation	608	
Comma	340	
Commands	315	
Colon	340	
Comma	340	
Command line structure	340	
common	315	

- Double dagger 340
 - GBIP, addressed 321
 - GBIP, universal 320
 - instrument control 315
 - Overlapping 342
 - Question mark 340
 - Quotation mark 340
 - SCPI compliant 315
 - Sequential 342
 - Syntax elements 340
 - White space 340
 - Command sequence
 - recommendation 352
 - remote 358
 - Common commands
 - Syntax 334
 - Composite AM State - DME Modulation 252, 253
 - Compression ratio
 - Chirp Modulation 235
 - Computer name
 - Changing 36
 - Computer name - Setup 92
 - CONDition 346
 - Config
 - Power Analysis 156
 - Confirm Password - Setup 99
 - Connection to an external controller 37
 - Connector
 - AM EXT 20, 24
 - AUX I/O 22
 - CLK SYN 24
 - EXT TUNE 23
 - FM/PM EXT 20, 24
 - GPIB 22
 - IEC/IEEE 22
 - INSTR TRIG 22
 - LAN 23
 - LF 20, 24
 - PULSE EXT 22
 - PULSE SYNC 23
 - PULSE VIDEO 22
 - REF IN 23
 - REF OUT 23
 - RF 21
 - RF OUT 24
 - SENSOR 21, 24
 - USB 21
 - USB type A 22
 - USB type B 22
 - Control bus 653
 - Controller, external 37
 - Copy instrument settings 113, 384
 - Counter 84, 367
 - Count – LF Frequency Sweep 532
 - Coupling mode 222
 - external modulation input 455
 - FM 496
 - FM/PM EXT 562
 - Coupling mode - EXT MOD (AM) 218
 - Course Sector (ILS-LOC) 279
 - Create New Directory 113
 - CSV Decimal Point Hardcopy - Power Analysis 187, 415
 - CSV Header Hardcopy - Power Analysis 187, 415
 - CSV Orientation Hardcopy - Power Analysis 187, 416
 - CSV Separator Hardcopy - Power Analysis 187, 416
 - Current Freq
 - LF Sweep 527
 - Current Freq (LF Sweep) 295
 - Current Freq (RF Sweep) 194, 502
 - Current Index 545
 - List Mode 207
 - Current Level 201, 570
 - Current of the ILS indicating instrument 268, 274
 - Current Sensors 88
 - Cursor keys 19
 - Cut 113
- D**
- Data Valid 653
 - Date - Setup 91
 - DAV 653
 - Day Hardcopy File Name 375
 - Power Analysis 186
 - Day Hardcopy File Name - Power Analysis 419
 - DCL 321
 - DC Offset
 - Clock Synthesis 312
 - DC Offset - Clock Synthesis 365
 - DC Offset - LF Output 300, 529
 - DDM (Difference in Depth of Modulation)
 - ILS-LOC modulation 274
 - DDM (Difference in Depth of Modulation) - ILS-GS Modulation 268
 - DDM (Difference in Depth of Modulation) - ILS-LOC Modulation 515, 517
 - DDM logarithmic value
 - ILS-GS modulation 517
 - ILS-LOC modulation 274, 517
 - DDM percent value
 - ILS-LOC modulation 275
 - DDM percent value - ILS-GS Modulation 268
 - DDM Polarity
 - ILS-LOC modulation 273
 - DDM Polarity - ILS-GS modulation 267, 518
 - DDM Polarity - ILS-LOC modulation 518
 - DDM to SDM Coupling
 - ILS-LOC modulation 275
 - DDM to SDM Coupling - ILS-GS modulation 269
 - Deactivate RF output 125, 592
 - Decimal Point Import/Export
 - List Mode data 542
 - Pulse Train data 310
 - Decimal Point Import/Export - List Mode data 211, 589
 - Decimal Point Import/Export - User Correction data 142, 467
 - DEF 338
 - Default instrument settings 29, 81, 359
 - Default values
 - remote 357
 - Define Reference - Power Analysis 159
 - Delay, external trigger - DME Modulation 246, 493
 - Delay time
 - NRP-Z level control 137
 - NRP-Z power control 573
 - Delete Hardcopy Files 374
 - Power Analysis 186
 - Delete Hardcopy Files - Power Analysis 418
 - Delete instrument settings 113, 385
 - Delta Phase 119, 560

Depth		List Mode	207
Marker Beacon modulation	283	RF Sweep	596
Destination - Hardcopy	104	E	
Destination Import/Export		Edit	
List Mode data	543	Pulse Train	308
Pulse Train data	310	Edit Pulse Train Data	308
User Correction data	142	Edit User Correction Data	139
Destination Import/Export - List Mode data	211	EFC (Electronic Frequency Control)	124
Destination Import/Export - Pulse Train data	591	EFC mode (Electronic Frequency Control)	124
Destination Import/Export - User Correction data	468	EMF - Level display	132
Deviation:REF signal - VOR Modulation	611	Enable	
Deviation internal		LAN interface	100
FM	498	ENABle	346
PhiM	563	Enable/disable beep	620
Deviation REF signal		Enable registers	
VOR modulation	261	remote	356
Device ID	87	Enter License Key	87
Device reset	359	EOI	653
Device-specific commands	315	Equal Distribution	
Device-specific error messages	651	Noise	559
DHCP	35	Error messages	59
Dialog		Adjustment data invalid (183)	652
close	368	Adjustment data missing (182)	651
ID	369	Adjustment failed (180)	651
open	369	Cannot access hardware (200)	652
Digital modulation signal	218	Cannot access the EEPROM (202)	652
FM	499	Cannot open file (460)	652
PhiM	565	Cannot read file (462)	652
Direction		Cannot write file (461)	652
Chirp modulation	234	Driver initialization failed (204)	652
VOR modulation	260	Extern reference out of range or disconnected (50)	651
Directory	111, 383	File contains invalid data (465)	652
Directory Hardcopy	374	Filename missing (463)	652
Power Analysis	186	Hardware revision out of date (201)	652
Directory Hardcopy - Power Analysis	418	Invalid EEPROM data (203)	652
Display	57, 101	Invalid filename extension (464)	652
annotate all	368	No current list (241)	652
annotate amplitude	368	This modulation forces other modulations off (140)	651
annotate frequency	368	Unknown list type specified (242)	652
close dialog	368	Error Messages	650
dialog ID	369	device-specific	651
open dialog	369	SCPI	651
state (screen saver)	370	Error messages - display list	631
wait time (screen saver)	369	Error queue query	619, 627, 628
Display permanent priority - Power Sensors	148	Error queues	
Distal Reference - Pulse Data Analysis	426, 446	recommendations	352
Distribution		ESR	345
Noise	559	Even distribution	300
Distribution Noise	300	EVENT	346
DME Analysis State	253	Event status enable register	
DME default	487	remote	355
DME modulation	236	Event status register	
Documentation Overview	13	remote	355
Double dagger	340	Exclude Frequency	111, 502
Double Pulse	302	Exclude Level	111, 569
Double Pulse Delay	303, 578	Execute Single	
Double Pulse State	578	List Mode	207
Double Pulse width	303, 578	Execute Single - List Mode	549
DOWN	338	Execute Single Sweep	
Drop out Time - Power Sensors	183, 433	Frequency Sweep	193, 596
Dual Code	222, 227	Level Sweep	200, 601
Dwell time		LF Sweep	530
List Mode	544	Execute Single Sweep - LF Sweep	295
Dwell Time	196, 201, 207, 296		
Level Sweep	601		
LF Sweep	530		

- Expected Reply Delay - DME Modulation 473
- Expiration date of option 86
- Export Deactivation Response 88
- Ext. FM Mode 222
- Ext. PhiM Mode 227
- Ext AM
 - ILS-GS Modulation 523
 - ILS-LOC modulation 282
 - ILS-LOC Modulation 523
 - VOR modulation 265
- Ext AM - ILS-GS Modulation 272
- Ext AM - VOR Modulation 612
- Extension Import/Export
 - List Mode data 540, 541
 - Pulse Train data 310
- Extension Import/Export - List Mode data 210, 588
- Extension Import/Export - User Correction data 141, 465, 466
- External digital modulation signal
 - FM 499
 - PhiM 565
- External impedance 525
 - Chirp Modulation 236
- External Impedance - DME Modulation 247
- External Impedance - Pulse Modulation 236, 494
- External Input Impedance 307
 - Pulse Trigger 586
- External modulation signal 215
 - AM 455
 - FM 218, 499
 - PhiM 565
- External modulation signal - PhiM 223
- External Reference Frequency 125, 592
- External tuning - Reference frequency 124
- Ext FM Mode 497
- Ext PhiM Mode 563
- EXT REF 648
- Ext trigger input slope
 - Chirp Modulation 235
- EXT TUNE input 124
- F**
- Factory Preset 103, 360
- FHOP_DATA 654
- File - Hardcopy dialog 104
- File list 111, 382
- File menu 109
- File Name - Hardcopy 104, 105
- File setup - Hardcopy 105
- File type selection 112
- Fill Table
 - List Mode 208
- Fill Table From 212
- Fill Table - List mode 211
- Fill Table Range 143, 212
- Filter
 - Power Sensors 149
- Filter Length
 - Power Sensors 149
- Filter Length - Power Sensors 401, 402, 403
- Fine adjustment - Reference frequency 126, 594
- Firmware version 86
- Floating licences 86
- Fly
 - ILS-GS Modulation 516
 - ILS-LOC modulation 274
 - ILS-LOC Modulation 516
- Fly - ILS-GS Modulation 267
- FM
 - Frequency 221
 - Shape 221
- FM:carrier - VOR Modulation 613
- FM carrier
 - VOR Modulation 261
- FM-DC mode 124
- FM Deviation 220, 221, 496, 497
- FM Deviation 1/2 498
- FM External Coupling 222, 496
- FM internal source 220, 498
- FM Mode 219, 498
- FM Sensibility 499
- FM Sensitivity 221
- FM Source 219, 499
- FM State 219, 500
- FREQ OFFSET 647
- Frequency 128
 - AM 526
 - antenna lobe - ILS-GS Modulation 269, 519, 524
 - antenna lobe - ILS-LOC Modulation 276, 522
 - Clock Synthesis 312
 - COM/ID signal 260
 - COM/ID signal - VOR Modulation 613
 - FM carrier 261
 - FM carrier - VOR Modulation 613
 - LF generator 526
 - List mode 544
 - List Mode 208
 - Marker Beacon modulation 283
 - PM 302, 526
 - Power Sensors 149
 - Pulse Modulation 579
 - REF signal 260
 - REF signal - VOR Modulation 613
 - RF output signal 501
 - RF Sweep 507
 - VAR signal 260
 - VAR signal - VOR Modulation 613
- Frequency - Clock Synthesis 363
- Frequency display 57
- Frequency - LF generator 299
- Frequency - Modulation chirp 235
- Frequency - Multiplier 118
- Frequency Offset 117, 504
 - Multiplier 504
- Frequency Range Mode - RF Signal 122, 505
- Frequency Range - RF Signal 123, 504, 505
- Frequency - RF output signal 116
- Frequency - RF Signal 117
- Frequency - RF Sweep 194
- Front panel key emulation 77
- FTP
 - LAN Services 100
- Fullscreen view
 - Power Analysis 166
- Fullscreen view - Power Analysis) 442
- Fuses 27

G

Gate	
Average Power	170, 392
Peak Power	170, 393
Trace	393
Gated	
pulse trigger input	307
Gated signal	
Chirp Modulation	235
Gated Signal	
Pulse Modulation	303, 587
Gated Signal - DME Modulation	246, 492
Gate input polarity	
Chirp Modulation	235
Gate Input Polarity	307
Pulse Modulation	586
Gate Input Polarity - Chirp Modulation	235
Gate Length - DME Modulation	254, 473
Gate polarity, trigger - DME modulation	247, 494
Gate Start	
Power Analysis	170, 393
Gate State	
Power Analysis	170, 394
Gate Stop	
Power Analysis	170
Gate view	
Power Analysis	166
Gate view - Power Analysis)	442
Gateway - Setup	93, 621, 623
Gaussian distribution	300
Gaussian Distribution	
Noise	559
GET	321
Getting started	44
GPIO	94
Characteristics	320
interface messages	320
Remote control interface	314
GPIO address	321, 621
GPIO bus address	96
GPIO bus control	
remote	356
GPIO - Visa Resource String	97
Grid	
Power Analysis	166, 396
GTL	321

H

Hardcopy Data - Power Analysis	413
Hardcopy - Destination	104, 372
Hardcopy Device - Power Analysis	414
Hardcopy Device Size	378
Power Analysis	186
Hardcopy Device Size - Power Analysis	416
Hardcopy dialog - File	104
Hardcopy File Name	373, 375
Power Analysis	185
Hardcopy File Name - Power Analysis	417, 418
Hardcopy - File setup	105
Hardcopy Format	373, 378
Hardcopy Format - Power Analysis	415
Hardcopy Path	374
Hardware Config	84, 366
Hardware options	85
High Power Option	202, 205

HiSLIP	
Protocol	317
Resource string	316
HiSLIP - Visa Resource String	97, 621
Hostname - Setup	92
HTTP	
LAN Services	100
Hysteresis	
Power Sensors	183
Hysteresis - Power Sensors	433
I	
ICAO Channel	
ILS-LOC modulation	281
ICAO Channel - DME modulation	241
ICAO Channel - ILS-GS Modulation	271
ID Dash Length - DME Modulation	251, 481
ID Dot length - DME Modulation	251, 482
Identification	
remote	355
Identification mode	95, 629
ID Frequency - DME Modulation	250, 484
ID Letter Length - DME Modulation	251
ID Letter Space - DME Modulation	483
IDN String	96
IdPDbsweepResAll	604
ID Period - DME Modulation	250, 483
ID signal	
ILS-LOC modulation	277
ID signal code	
ILS-LOC modulation	277
ID signal code - DME Modulation	249, 481
ID State - DME Modulation	249, 484
ID Symbol Space - DME Modulation	251, 485
ID Time Schema - DME Modulation	250, 485
IFC	321, 653
ILS-Gs default	270
ILS-GS default	522
ILS-GS modulation	266, 272
ILS-GS Source	523
ILS-LOC default	276, 287, 522
ILS Source	282
Impedance	
external input	222, 227
External Inputs	586
Impedance - RF outputs	389
Impedance Trigger/Gate Signal - DME Modulation	
	247
Impedance Trigger/Gate Signal - Pulse Modulation	
	236, 494
Import/Export	
List Mode data	211, 542
Pulse Train data	309, 310
User Correction data	141, 142
Import/Export - List Mode data	210, 590
Import/Export - User Correction data	467
Import License Key	87
Indication	169, 176
Indication - Trace power analysis	158
INF	338
INFO key	59
Input	
ILS-LOC modulation	272
PULSE EXT	231
VOR modulation	258
Input connector	23

- Input - ILS-GS Modulation 266
 - Installed Assembly 85
 - Instrument Config 84, 366
 - Instrument current
 - ILS-LOC modulation 274
 - Instrument current - ILS-GS Modulation 268
 - Instrument messages 315
 - Instrument settings
 - recall 357, 386
 - save 357, 387
 - Instrument settings - recall 110
 - Instrument settings - save 109
 - Instrument Trigger 196, 202, 210, 297
 - Instrument trigger input slope 525
 - Interface
 - functions (GPIB bus) 654
 - Interface Clear 653
 - Interface messages 315, 318
 - Interfaces
 - GPIB 320
 - USB 319
 - Internal deviation 221, 226
 - FM 498
 - PhiM 563
 - Internal source 216, 220, 226
 - Internal Source
 - AM 455
 - FM 498
 - PhiM 563
 - Interrogation signal - DME 238, 486
 - Interrupt 350
 - IP address 316
 - Changing 35
 - IP Address Mode 622
 - IP Address Mode - Setup 92
 - IP Address - Setup 93, 623
 - IST 345
 - IST flag 348
 - remote 355
- K**
- Key
 - Arrow key 20
 - BACKSPACE 18
 - Cursor key 20
 - DIAGRAM 18
 - ENTER 19
 - ESC 18
 - FILE 17, 108
 - FREQ 17
 - HELP 16
 - INFO 16
 - LEVEL 17
 - LOCAL 16
 - MENU 18
 - MOD ON/OFF 17, 213
 - ON/OFF 18
 - PRESET 16, 29, 81
 - REARR 17
 - RF ON/OFF 17
 - SETUP 16, 82
 - TOGGLE 18
 - WINBAR 18
 - Keyboard 101
 - Keyboard Language 379
 - Keyboard Layout 94, 379
 - Key combinations 76
 - Key - HELP 107
 - Key - LOCAL 103
 - Keypad 18
 - Keywords
 - see Mnemonics 334
- L**
- LAN
 - Configuration 34
 - Interface 316
 - IP address 316
 - Remote control interface 314
 - VISA 316
 - VXI protocol 318
 - Language Keyboard 379
 - LAN interface
 - Avahi 100
 - enable 100
 - FTP 100
 - HTTP 100
 - LAN over SCPI 100
 - SMB (Samba) 100
 - SSH 100
 - VNNC 100
 - LAN Interface
 - services 100
 - setup 100
 - Layout Keyboard 94, 379
 - Learn List Mode Data 207, 547
 - Level 128
 - limit 129, 137
 - Power Sensors 147, 148
 - RF output 129, 568
 - Step width 575
 - uninterrupted setting 129
 - Level control 132, 566
 - Level display 57
 - Level display EMF 132
 - Level limit 570
 - RF level 129, 137
 - Level Noise
 - LF Output 559
 - Level Noise - LF Output 301
 - Level offset 129, 569
 - Power Analysis 172, 408, 423, 424
 - Level Offset
 - Power Sensors 149
 - LEVEL OFFSET 648
 - Level offset state
 - Power Analysis 172, 408, 424, 425
 - Level - Step width 131
 - LevelSweep 649
 - Level Sweep 196, 571
 - Level - Uninterrupted setting 389
 - Level user correction 138
 - LF generator 291
 - LF Generator
 - Shape 299
 - LFGen Frequency 299
 - LF gen Frequency 217, 221, 226
 - LF Gen Frequency 526
 - LF Gen Voltage 298, 536
 - LF output 297, 298
 - LF Output State 298, 530
 - LFSweep 649

- LF Sweep 295, 528
 Licence for software option 86
 License Key 87
 Limit
 Level 129, 137, 570
 Linux 32
 Linux controller 39
 ListMode 649
 List mode 202, 571
 manual processing of lists 205
 List Mode Data 208
 List Range In 209, 546
 LLO 321
 Load instrument settings 110, 357, 386
 Local - Remote Channel Control 97
 Local to remote switchover 322, 323
 Lock keyboard 629
 LOC-LLO 649
 Low Spectral Emmission - DME Modulation 245, 486
- M**
- Malfunctions
 reacting 352
 Manual Remote Control 37
 Marker
 Power Analysis 184
 Marker Beacon modulation 282
 Marker Depth
 Marker Beacon modulation 283
 Marker Frequency
 Marker Beacon modulation 283
 Marker indication
 Power Analysis 151
 Marker view
 Power Analysis 166
 Marker view - Power Analysis) 443
 Mathematics - Power Analysis 160
 Max
 Power Analysis 162
 MAX 338
 Maximal deviation 225
 FM 220, 496
 PhiM 561, 562
 Maximal deviation - Chirp modulation 234, 457
 Max - Power Analysis 411, 428, 435
 Max Separate Frequency - Power Analysis 173, 409
 Measured level
 NRP-Z level control 136
 Measurement Count - DME Modulation 254, 472
 Menu structure
 access denied 62
 header 61
 menu area 62
 Mesial Reference - Pulse Data Analysis 426, 447
 Messages
 commands 315
 instrument 315
 instrument responses 316
 interface 315
 Min
 Power Analysis 162
 MIN 338
 Min/max - Power Analysis 412, 413
 Min/max Y scale
 Power Analysis 165
 Min/max Y scale - Power Analysis 429, 430, 437
 Min - Power Analysis 410, 427, 434
 Min Separate Frequency - Power Analysis 173, 409
 Mnemonics 334
 Optional 336
 Mode 225
 Dig Ext FM 222
 Dig Ext PhiM 227
 Ext FM 497
 Ext PhiM 563
 FM 219, 498
 ILS-LOC modulation 275
 IP Address 622
 Level Sweep 197, 571, 601
 LF Gen 292, 527
 LF Sweep 292, 527, 531
 List Mode 205, 547
 PhiM 564
 RF Frequency 503
 RF frequency Sweep 191
 RF Sweep 503, 597
 VOR modulation 259
 Mode - DME modulation 238, 479, 486
 Mode - ILS-GS Modulation 269, 520
 Mode - ILS-LOC Modulation 521
 Mode Import/Export
 List Mode data 543
 Pulse Train data 310
 Mode Import/Export - List Mode data 210, 590
 Mode Import/Export - User Correction data 141, 468
 Mode IP Address - Setup 92
 Mode - VOR Modulation 610
 Mod Gen block 47
 MOD OFF 647
 MOD ON/OFF Key 213
 Modulation
 ADF 287
 AM 215
 Chirp Modulation 231
 FM 218
 ILS-LOC modulation 272
 Marker Beacon modulation 282
 PhiM 223
 PM 229
 Pulse modulation 229
 VOR modulation 258
 Modulation chirp - repetition frequency 235
 Modulation depth
 FM carrier - VOR Modulation 613
 PhiM 225
 VOR modulation 261
 Modulation Depth 217
 Modulation depth - AM 216, 454, 455
 Modulation deviation 226
 FM 220, 221, 496, 497
 PhiM 561, 562
 Modulation deviation - Chirp 234, 457
 Modulation - DME modulation 236
 Modulation - ILS-GS 266
 Month Hardcopy File Name 376
 Month Hardcopy File Name - Power Analysis 419, 420
 Multiplier
 Frequency Offset 504
 Multiplier - Frequency 118
 Multi transmitter measurements 132

N

NAN	338
Navigation keys	19
NDAC	653
Network Settings	91
Network Status	92
New Password - Setup	99
NINF	338
Noise	
Bandwidth	558
Bandwidth Limitation	300
Distribution	300
Noise Distribution	559
Noise Level	559
Noise Level (System Bandwidth)	559
Noise Level (System Bandwidth) - Noise	301
Noise Level - Noise	301
Noise signal	558
No-load voltage (EMF)	132
Normalize Setup- DME Modulation	256, 474
Normalize Trigger - DME Modulation	494
Normalize Trigger- DME Modulation	247
NRFD	653
NRP-Z Info	88
NRP-Z level control	134
catch range	137
delay time	137
measured level	136
sensor	135
state	136
target level	137
use peak power	137
NRP-Z power control	
catch range	573
delay time	573
RF level limit	129, 137
sensor	574
state	574
target level	574
use peak power	573
use SParameter	137, 151
NRP-Z power viewer	
use SParameter	137, 151
NTRansition	346
Number Hardcopy File Name	376
Number Hardcopy File Name - Power Analysis	420
Number of licences	86
Numeric values	
Special	338

O

Offset	
Frequency	504
Level	569
Offset binary	222, 227
Offset - Clock Synthesis	365
Offset - Frequency	117
Offset - Level	129
Offtime	
Pulse Train	308, 582
Old password - Setup	99
Online help	
Working with	71
Ontime	
Pulse Train	308, 583

Operating concept	44
Operating system	32
Operation complete	
remote	356
Operation hours	85, 367
Option	
Hardware	85
High Power	202, 205
R&S SMA-B81	24
Software	85
Option: expiration date	86
Option identification	
remote	356
Options - Hardcopy	104
OPT String	96
Output	
CLK SYN	311
Output buffer	345
Output connector	20, 21, 22, 23
Output - LF	297
Output voltage 1/2- LF Output	299, 529
Output Voltage - LF output	298
OvenCold	650
Overlapping	
preventing	343
Overlapping commands	342
Overload	131
OVERLOAD	648

P

Packing	646
Parallel poll register enable	
remote	356
Parameters	
Block data	340
Boolean	339
SCPI	337
Special numeric values	338
String	340
Text	339
Units	338
Parity	625
Parity - RS232 Interface	96
Part numbers	84
Paste	113
Path reset	359
PCI bus	85
Peak Level - DME Modulation	254, 474
Peak Level State - DME Modulation	254, 475
Peak Level Validity - DME Modulation	475
Phase	
antenna lobe - ILS-GS Modulation	270, 521
antenna lobe - ILS-LOC Modulation	276, 521
RF output signal	560
Phase continuous Active	122
Phase continuous Active - RF Signal	506
Phase - RF output signal	119
PhiM	
Frequency	226
Shape	226
PhiM Depth	225
PhiM Deviation	226, 562
PhiM External Coupling	227, 562
PhiM Internal Deviation 1/2	563
PhiM internal source	226, 563
PhiM Mode	225

- PhiM Sensitivity 227
 - PhiM Source 225, 565
 - PhiM State 225, 565
 - PM Deviation 561
 - PM Frequency 526
 - PM Sensitivity 564
 - PniM Mode 564
 - Point-to-point connection 34
 - Polarity
 - Pulse Modulation 231, 580
 - Power
 - List Mode 208
 - Power-On Count 84, 85
 - Power-On Counter 367
 - Power-On State 132, 390
 - Power sensors
 - NRP-Z level control 134
 - zero 136, 148
 - PPC 321
 - PPE 345
 - PPE register 348
 - PPU 321
 - Prefix Hardcopy File Name 377
 - Prefix Hardcopy File Name - Power Analysis 420
 - Preset 29
 - Preset instrument settings 29
 - Preset - instrument settings 81, 359
 - Protection 97
 - Protocol
 - VXI 318
 - Proximal Reference - Pulse Data Analysis 427, 447
 - PTRansion 346
 - Pulse Analysis State - Pulse Data Analysis 425
 - Pulse data indication
 - Power Analysis 151
 - Pulse Data Indication
 - Average Power 445
 - Distal Power 445
 - Duty Cycle 445
 - Fall Time 445
 - Mesial Power 445
 - Minimal Power 445
 - Overshoot Falling Edge 445
 - Overshoot Rising Edge 445
 - Peak Power 445
 - Proximal Power 445
 - Pulse Base Level 445
 - Pulse Off Time 445
 - Pulse Period 445
 - Pulse Start Time 445
 - Pulse Stop Time 445
 - Pulse Top Level 445
 - Pulse Width 445
 - Rise Time 445
 - Pulse Data View
 - Power Analysis 166
 - Pulse Data View - Power Analysis 444
 - Pulse Delay 303, 577
 - Pulsed Marker
 - Marker Beacon modulation 283
 - Pulse External Impedance 307
 - Pulse Fall - Modulation DME 245, 481
 - Pulse generator
 - Signal valid as pulse sync 579
 - Pulse Generator
 - Pulse Train 307
 - Pulse generator state 302, 560
 - Pulse Mode 302, 579
 - Pulse modulation 229
 - repetition frequency 302, 526, 579
 - Signal valid as pulse sync 579
 - Pulse period 302, 579
 - Chirp modulation 235
 - Pulse Repetition Frequency - DME Modulation 256, 475
 - Pulse Repetition Frequency State - DME Modulation 255, 476
 - Pulse Repetition Frequency Validity - DME Modulation 476
 - Pulse Repetition Rate - DME modulation 244, 487
 - Pulse Rise - Modulation DME 244, 488
 - Pulse shape 244, 489
 - Pulse Spacing - DME modulation 245, 487
 - Pulse Squitter - DME modulation 489
 - Pulse Squitter - DME modulation 243
 - Pulse Train 302
 - Pulse Generator 307
 - Pulse Train Data 308
 - Pulse trigger input slope 235, 306, 586
 - Pulse width 303, 591
 - Chirp modulation 235
 - Pulse width - DME modulation 245, 495
- ## Q
- Queries 315, 341
 - Status 351
 - Question mark 340, 341
 - Quotation mark 340
- ## R
- Rackmounting 27
 - Range Distance - DME Modulation 243, 488
 - Recall instrument settings 110, 111, 357, 386
 - Recall intermediate 357
 - Recall Intermediate 112
 - Recent data sets 111
 - Recommendations
 - remote control programming 352
 - Reference frequency
 - external 125
 - Reference frequency adjustment mode 126, 594
 - Reference frequency - external 592
 - Reference oscillator 124
 - REF OUT output 124
 - Registers 345
 - REM-LLO 649
 - REMOTE 648
 - Remote access 37
 - Remote control
 - Basics 314
 - GPIB address 321
 - Interfaces 314
 - Protocols 314
 - Remote Control
 - GPIB 323
 - Remote control switchover 322
 - REN 653
 - Rename 113, 386
 - Repetition
 - Pulse Train 308
 - Repetition rate - DME modulation 244, 487
 - Reply Delay - DME Modulation 255, 477

- Reply Delay Status- DME Modulation 255, 478
 - Reply Delay Validity- DME Modulation 478
 - Reply Efficiency - DME Modulation 244, 255, 471, 480
 - Reply Efficiency State- DME Modulation 255, 472
 - Reply Efficiency Validity - DME Modulation 472
 - Reply signal - DME 238, 486
 - Reset
 - List Mode 207
 - Reset Auto Scale
 - Power Analysis 151, 166
 - Reset Auto Scale - Power Analysis 412, 429, 436
 - Reset Delta Phase Display 119, 560
 - Reset device parameters 359
 - Reset instrument settings 29, 81, 359
 - Reset path 359
 - Reset values
 - remote 357
 - Restart Network - Setup 93
 - Reverse power protection 131
 - Revisions 84
 - RF block 48
 - RF frequency 117, 501
 - RF Level
 - limit 129, 137
 - RF level limit
 - NRP-Z power control 129, 137
 - RF OFF 647
 - RF OFF mode
 - attenuator settings 567
 - RF ON/OFF key 114, 390
 - RF output
 - Power-on state 132
 - RF output level 129, 568
 - RF output - Power-on state 390
 - RF output signal
 - Phase adjustment 560
 - RF output signal - Phase adjustment 119
 - RF Signal - Frequency 117
 - RFSweep 649
 - Rotary knob 20
 - RS232 interface 96
 - RS232 Interface
 - Baudrate 625
 - Parity 625
 - Stop bits 625
 - Run Update 88
- S**
- Sample&Hold mode 132
 - Sample-and-Hold mode 566
 - Save
 - Power Analysis 185, 186
 - Save immediate 109
 - Save instrument settings 109, 357, 387
 - Save intermediate 357
 - Save Options Hardcopy
 - Power Analysis 186
 - Save to Ref - Power Analysis 159
 - SCPI
 - LAN Services 100
 - Parameters 337
 - Syntax 334
 - Version 314
 - SCPI compliant commands 315
 - SCPI - error messages 651
 - Screen Saver 93
 - SDC 321
 - Search Once - ALC 134, 567
 - Search Trigger Level - DME Modulation 247
 - Security Password - Setup 102
 - Security settings
 - LAN services 100
 - Security Settings
 - Accept 102
 - Annotation Amplitude 101
 - Annotation Frequency 101
 - Change Password 99, 100
 - Confirm Password 99
 - Display 101
 - Keyboard 101
 - New Password 99
 - Old Password 99
 - Security Password 102
 - USB storage 101
 - User Name 98
 - Select ASCII Destination
 - Pulse Train data 310
 - User Correction data 142
 - Select ASCII Destination - List Mode data 211
 - Select ASCII Source
 - Pulse Train data 310
 - User Correction data 142
 - Select List 208, 549
 - Select NRP File 88
 - Select Operation - File menu 109
 - Select Pulse Train Data 308
 - Select pulse train file 585
 - Selftest
 - remote 358
 - Sensor
 - NRP-Z level control 135
 - NRP-Z power control 574
 - Sensor - Power Sensors 146
 - Sequential commands 342
 - Serial bus 85
 - Serial interface 96
 - Serial numbers 84
 - Serial - Visa Resource String 97
 - Service request (SRQ) 348, 350
 - Service request enable
 - remote 357
 - Service request enable register (SRE) 348
 - Setting commands 315
 - Setting not possible 62
 - Setting parameters 63
 - Set to default 96
 - Set To default - DME Modulation 245
 - Set To default ID - DME Modulation 251, 484
 - Setup
 - LAN services 100
 - Setup key 82
 - Shape
 - LF Sweep 533
 - RF Level Sweep 201, 602
 - RF Sweep 598
 - Shape - LF Frequency Sweep 295
 - Shape - LF generator 299
 - Shape - RF Sweep 194
 - Show level permanent - Power Sensors 148, 401
 - Signal valid as pulse sync
 - pulse generator 579
 - pulse modulation 579

Single Pulse	302	Startup complete	631
Single Pulse - DME modulation	245, 489	State	
Slope		ADF Modulation	288
Instrument trigger input	525	ALC	134, 567
pulse trigger input	306, 586	Chirp modulation	233
Slope, trigger - DME modulation	247, 495	Clock Synthesis	312
Slope - pulse trigger input	235	DC Offset	312
SMB (Samba)		ILS-GS Modulation	524
LAN Services	100	ILS-LOC modulation	273
Software options	85	ILS-LOC Modulation	524
Source		List Mode	205, 503
AM	456	Marker Beacon modulation	283
FM	219, 499	NRP-Z level control	136
ILS-GS Modulation	523	NRP-Z power control	574
ILS-LOC Modulation	523	PhiM	225
Level Sweep Trigger	197, 637	Power Sensors	147
LF Sweep Trigger	292, 634	Pulse Generator	302, 560
List Mode	205	Pulse Modulation	230, 581
List Mode Trigger	550	Pvideo-Sync Signal	302
PhiM	225, 565	screen saver	370
Power Sensors	149	Video-Sync Signal	560
Pulse Modulation	230, 580	VOR modulation	259
Reference Oscillator	594	State - Chirp modulation	233
RF frequency Sweep Trigger	191	State - Clock Synthesis	364
RF Sweep Trigger	635	State - DME modulation	238
Source - AM	216	State - DME Modulation	490
Source Import/Export		State - ILS-GS Modulation	267
List Mode data	543	State - User Correction	139
Pulse Train data	310	State - VOR Modulation	612
User Correction data	142	Status	
Source Import/Export- Pulse Train data	591	Queries	351
Source Import/Export- User Correction data	468	Status byte	
Source LF Output	298	remote	354, 358
Source - Power Sensors	405	Status Information	88
Source - Reference Oscillator	125	status messages	
Source - VOR Modulation	612	ALC On	649
Spacing		AttFixed	649
Level Sweep	201, 603	Auto	649
LF Sweep	533	BUSY	648
Power Analysis	163	EXT REF	648
RF Sweep	598	FREQ OFFSET	647
Spacing - LF Sweep	295	LEVEL OFFSET	648
Spacing - Power Analysis	410, 427, 434	LevelSweep	649
Spacing - RF Sweep	194	LFSweep	649
Span (RF sweep)	194, 506	ListMode	649
SPD	321	LOC-LLO	649
SPE	321	MOD OFF	647
Special characters		OvenCold	650
SCPI	337	OVERLOAD	648
Squitter - DME modulation	489	REM-LLO	649
Squitter - DME modulation	243	REMOTE	648
SRE	345	RF OFF	647
SRE (service request enable register)	348	RFSweep	649
SRQ	653	S&H	649
SRQ (service request)	348, 350	Table	649
SSH		UCorr	649
LAN Services	100	Status registers	345
Standard View - Power Analysis	444	CONDition	346
Standby mode	16	ENABLE	346
Start		EVENT	346
Power Analysis	157	model	346
Power Sensors	397	NTRansition	346
Start/Stop Gui Update	88, 626	parts	346
Start Freq	194, 507	PTRansition	346
LF Sweep	528	Status reporting system	345
Start Freq - LF Sweep	295	Application	349
Start Level	200, 574	common commands	354

STB	345
Step	
Level Sweep	201, 603
Power Analysis	163
Step Lin	
LF Sweep	533
RF Sweep	599
Step Lin - LF Sweep	296
Step Lin - RF Sweep	195
Step Log	
LF Sweep	534
RF Sweep	600
Step Log - LF Sweep	296
Step Log - RF Sweep	195
Step - Power Analysis	410, 428, 435
Step width	
carrier frequency	264
carrier frequency - ILS-GS Modulation	270, 271, 518
carrier frequency - ILS-LOC Modulation	279, 280
carrier frequency - marker Beacon Modulation	286
Clock Synthesis	313
Frequency	508
Level Sweep	201, 603
RF Sweep	599
Step width - Clock Synthesis	364
Step width - Frequency	118
Step width - RF Sweep	195
Stop bits	625
Stop bits - RS232 Interface	96
Stop Freq	
LF Sweep	529
RF Sweep	508
Stop Freq - LF Sweep	295
Stop Freq - RF Sweep	194
Stop Level	201, 576
Storing	646
Subcarrier	
VOR modulation	261
Subcarrier - VOR Modulation	613
Subnet Mask - Setup	93, 623
Suffixes	336
Sum modulation depth	
ILS-GS Modulation	523
ILS-LOC modulation	274
ILS-LOC Modulation	523
Sum modulation depth - ILS-GS Modulation	267
Sweep	
Center frequency	501
LF start frequency	528
LF stop frequency	529
RF frequency Sweep	191
RF Sweep	503, 571, 597
Start Level	200, 574
Stop Level	201, 576
Trigger	193, 200, 637
Sweep - Center frequency	194
Sweep - LF start frequency	295
Sweep - LF stop frequency	295
Sweep shape	
LF Sweep	533
RF Level Sweep	201, 602
RF Sweep	598
Sweep shape - LF Frequency Sweep	295
Sweep shape - RF Sweep	194
Sweep spacing	
Level Sweep	201, 603
RF Sweep	598
Sweep spacing - RF Sweep	194
Sweep - Trigger	295
Synchronization bandwidth – Reference oscillator	125
Synchronization bandwidth	
Reference oscillator	593
Syntax elements	
SCPI	340
System	
identification	95
System directory	379
System Settings - Setup	93
T	
Target level	
NRP-Z level control	137
NRP-Z power control	574
Terminator recognition	620
Time - Setup	91
Timing	
Power Analysis	163
Timing - Power Analysis	411, 428
Toggle Summary Screen	94
Trace Color - Power Analysis	161, 440
Trace - Gate	169
Trace Value	
Average Power	443
Distal Power	443
Duty Cycle	443
Fall Time	443
Mesial Power	443
Minimal Power	443
Overshoot Falling Edge	443
Overshoot Rising Edge	443
Peak Power	443
Proximal Power	443
Pulse Base Level	443
Pulse Off Time	443
Pulse Period	443
Pulse Start Time	443
Pulse Stop Time	443
Pulse Top Level	443
Pulse Width	443
Rise Time	443
Trapeze Fall - LF Output	300, 535
Trapeze High - LF Output	300, 535
Trapeze Low - LF Output	300, 536
Trapeze Rise - LF Output	299, 536
Trigger	
Power Sensors	182
Trigger event	
remote	358
Triggering sweep manually	200, 596, 601
Trigger Input Slope	196, 202, 210, 297
Trigger Level	
Power Sensors	182
Trigger Level - DME Modulation	248
Trigger Level - Power Sensors	433
Trigger mode	
Chirp Modulation	235
Trigger Mode	
Power Sensors	182
Pulse Modulation	303, 587

- Trigger Mode - DME Modulation 246, 492
 - Trigger - Power Sensors 434
 - Trigger Source
 - Level Sweep 197, 637
 - LF Sweep 292, 634
 - List Mode 205, 550
 - RF frequency Sweep 191
 - RF Sweep 635
 - Two's Complement 222, 227
 - Type
 - Power Sensors 147
 - Type - Power Sensors 437, 438
- U**
- UCorr 649
 - Ultr@VNC 39
 - Uninterrupted level setting 129, 389
 - Unit
 - Power Sensors 148
 - Units 338
 - Input 18
 - UNIX controller 39
 - UP 338
 - Update sensor 88
 - Update - Setup System 89
 - USB
 - Interfaces 319
 - USB Storage - Setup 101
 - Use as X Scale - Power Analysis 173
 - Use peak power
 - NRP-Z level control 137
 - NRP-Z power control 573
 - User Correction 138
 - User Correction Data 139, 463
 - User Name - Setup 98
 - Use Separate Frequency - Power Analysis 172, 409, 424, 432
 - Use SParameter
 - NRP-Z power control 137, 151
 - NRP-Z power viewer 137, 151
 - Use SParameters
 - Power Analysis 171
 - Use SParameters - Power Sensors 400
- V**
- Value - User Correction 139
 - VAR/Ref Frequency
 - VOR modulation 260
 - VAR/Ref Frequency - VOR Modulation 613
 - VAR Depth - VOR Modulation 614
 - Variation Active 118
 - Clock Synthesis 313
 - Variation Active - Clock Synthesis 365
 - Variation Step 118, 131, 508, 509, 575
 - Clock Synthesis 313
 - Variation Step - Clock Synthesis 364
 - Video-Sync Signal state 302, 560
 - VISA 314, 316
 - Libraries 315
 - Resource string 315, 316
 - Visa Resource String 97
 - Ethernet 621, 624
 - GPIB 624
 - Serial 624
 - Socket 625
 - USB 624
 - Visible
 - Power Analysis 184
 - VNC
 - LAN Services 100
 - VNC connection 39
 - Voltage / Power related - Pulse Data Analysis 425, 446
 - Voltage - LF output 536
 - VOR modulation 258
 - VOR Source 612
 - VXI11 - Visa Resource String 97
 - VXI protocol 318
- W**
- Wait
 - remote 358
 - Wait time
 - screen saver 369
 - Wait Time 94
 - Warnings 59, 650
 - White space 340
 - Workgroup - Setup 622
- Y**
- y-axis
 - Power Analysis 165
 - Y-axis - Power Analysis 412, 413, 429, 430, 437
 - Year Hardcopy File Name 377
 - Year Hardcopy File Name - Power Analysis 421
- Z**
- Zero
 - power sensors 136, 148
 - Zero - Power Sensors 171, 248, 438
 - Zoom
 - Pulse Train 308
 - Zoom Position
 - Pulse Train 308