

To buy, sell, rent or trade-in this product please click on the link below:
<https://www.avionteq.com/Viavi-ALT-9000-Altimeter-Test-Set>



ALT-9000

Radio Altimeter Test Set

Operation Manual



ALT-9000

**Radio Altimeter
Test Set**

Operation Manual

PUBLISHED BY
VIAVI Solutions, Inc.

Original Issue	FEB 2022
Re-issued (001)	APR 2022

Notifications

Notice

Every effort was made to ensure that the information in this manual was accurate at the time of release. However, information is subject to change without notice, and VIAVI reserves the right to provide an addendum to this manual with information not available at the time that this manual was created.

Copyright/Trademarks

© Copyright 2022 VIAVI Solutions, Inc. All rights reserved. No part of this guide may be reproduced or transmitted, electronically or otherwise, without written permission of the publisher. VIAVI Solutions and the VIAVI logo are trademarks of VIAVI Solutions Inc. (“VIAVI”).

All other trademarks and registered trademarks are the property of their respective owners.

Patent Information

Patented as described at: <https://www.viavisolutions.com/en-us/corporate/legal/patents>.

Copyright Release

Reproduction and distribution of this guide is authorized for US Government purposes only.

Terms and conditions

Specifications, terms, and conditions are subject to change without notice. The provision of hardware, services, and/or software are subject to VIAVI’s standard terms and conditions, available at: <https://www.viavisolutions.com/en-us/corporate/legal/terms-conditions>.

Warranty Information

Warranty information for this product is available on the VIAVI website at: <https://www.viavisolutions.com/en-us/support/warranty-quality-compliance-policies>.

Regulatory Compliance

Declaration of Conformity

VIAVI recommends keeping a copy of the Declaration of Conformity Certificate (shipped with the unit) with the test set at all times.

EMC Directive Compliance

This product was tested and conforms to the EMC Directive, 2014/30/EU for electromagnetic compatibility.

DFARS Statement

If software is for use in the performance of a U.S. Government prime contract or subcontract, software is delivered and licensed as “Commercial Computer Software” as defined in DFAR 252.227-7014 (Feb 2014), or as a “Commercial Item” as defined in FAR 2.101(a) or as “Restricted Computer Software” as defined in FAR 52.227-19 (Dec 2007) or any equivalent agency regulation or contract clause. Use, duplication or disclosure of Software is subject to VIAVI Solutions' standard commercial license terms, and non-DOD Departments and Agencies of the U.S. Government will receive no greater than Restricted Rights as defined in FAR 52.227-19(c)(1-2) (Dec 2007). U.S. Government users will receive no greater than Limited Rights as defined in FAR 52.227-14 (June 1987) or DFAR 252.227-7015 (b)(2) (November 1995), as applicable in any technical data.

Open Source Disclaimer - IMPORTANT READ CAREFULLY

The ALT-9000 Radio Altimeter Test Set includes third party software licensed under the terms of separate open source software licenses. By using this software you agree to comply with the terms and conditions of the applicable open source software licenses. Software originated by VIAVI is not subject to third party licenses. Terms of the VIAVI Software License different from applicable third party licenses are offered by VIAVI alone.

Federal Communications Commission (FCC) Notice

This device complies with part 15 of the FCC Rules. Operation is subject to the following two conditions: (1) This device may not cause harmful interference, and (2) this device must accept any interference received, including interference that may cause undesired operation.

This equipment was tested and found to comply with the limits for a Class A digital device, pursuant to Part 15 of the FCC Rules. These limits are designed to provide reasonable protection against harmful interference when the equipment is operated in a commercial environment. This equipment generates, uses, and can radiate radio frequency energy and, if not installed and used in accordance with the instruction manual, may cause harmful interference to radio communications. Operation of this equipment in a residential area is likely to cause harmful interference, in which case you will be required to correct the interference at your own expense.

The authority to operate this equipment is conditioned by the requirements that no modifications be made to the equipment unless the changes or modifications are expressly approved by VIAVI.

Industry Canada Requirements

This device complies with Industry Canada's license-exempt RSSs. Operation is subject to the following two conditions: 1) This device may not cause interference; and, 2) This device must accept any interference, including interference that may cause undesired operation of the device.

Le présent appareil est conforme aux CNR d'Industrie Canada applicables aux appareils radio exempts de licence. L'exploitation est autorisée aux deux conditions suivantes: 1) l'appareil ne doit pas produire de brouillage; et, 2) l'utilisateur de l'appareil doit accepter tout brouillage radioélectrique subi, même si le brouillage est susceptible d'en compromettre le fonctionnement.

EU WEEE and Battery Directives

This product, and the batteries used to power the product, should not be disposed of as unsorted municipal waste and should be collected separately and disposed of according to your national regulations.

VIAVI has established a take-back processes in compliance with the EU Waste Electrical and Electronic Equipment (WEEE) Directive, 2012/19/EU, and the EU Battery Directive, 2006/66/EC.

Instructions for returning waste equipment and batteries to VIAVI can be found in the WEEE section of [VIAVI's Standards and Policies web page](#).

If you have questions concerning disposal of your equipment or batteries, contact the VIAVI WEEE Program Management team at WEEE.EMEA@VIAVISolutions.com.

EU REACH

Article 33 of EU REACH regulation (EC) No 1907/2006 requires article suppliers to provide information if a listed Substances of Very High Concern (SVHC) is present in an article above a certain threshold.

For information on the presence of REACH SVHCs in VIAVI products, see the Hazardous Substance Control section of [VIAVI's Standards and Policies web page](#).

EU CE Marking Directives (LV, EMC, RoHS, RE)

This product conforms with all applicable CE marking directives. Please see EU Declaration of Conformity for details.

California Proposition 65

California Proposition 65, officially known as the Safe Drinking Water and Toxic Enforcement Act of 1986, was enacted in November 1986 with the aim of protecting individuals in the state of California and the state's drinking water and environment from excessive exposure to chemicals known to the state to cause cancer, birth defects or other reproductive harm.

For the VIAVI position statement on the use of Proposition 65 chemicals in VIAVI products, see the Hazardous Substance Control section of [VIAVI's Standards and Policies web page](#).

Korea Certification

<p>A급 기기 (업무용 방송통신기자재) Class A Equipment (Industrial Broadcasting & Communications Equipment).</p>	<p>이 기기는 업무용(A급) 전자파적합기기로서 판매자 또는 사용자는 이 점을 주의하시기 바라며, 가정외의 지역에서 사용하는 것을 목적으로 합니다. This equipment is Industrial (Class A) electromagnetic wave suitability equipment and seller or user should take notice of it, and this equipment is to be used in the places except for home.</p>
--	--

Ordering information

This manual is a product of the VIAVI Technical Publications Department, issued for use with the ALT-9000 Radio Altimeter Test Set. The PDF format of this manual is available on the VIAVI product website.

Go to: <https://www.viavisolutions.com/en-us/resources/literature-library>

- Type ALT-9000 to find the manuals associated with the ALT-9000 Radio Altimeter Test Set.

Contact Information

Contact the Technical Assistance Center (TAC) for technical support or with any questions regarding this or other VIAVI products.

- Phone: 1-844-GO-VIAVI
- Email: Techsupport.Avcomm@viavisolutions.com

For the latest TAC information, go to:

<https://www.viavisolutions.com/en-us/support/technical-product-support/technical-assistance>

Precautions

SAFETY FIRST - TO ALL OPERATIONS PERSONNEL

GENERAL CONDITIONS OF USE

This product is designed and tested to comply with the requirements of IEC/EN61010-1 'Safety requirements for electrical equipment for measurement, control and laboratory use' for Class I portable equipment and is for use in a pollution degree 2 environment. The equipment is designed to operate from installation supply Category II.

Equipment should be protected from liquids such as spills, leaks, etc. and precipitation such as rain, snow, etc. When moving the equipment from a cold to hot environment, allow the temperature of the equipment to stabilize before the equipment is connected to the supply to avoid condensation forming.

The equipment must only be operated within the environmental conditions specified in the performance data.

CASE, COVER OR PANEL REMOVAL

Opening the Case Assembly exposes the operator to electrical hazards that may result in electrical shock or equipment damage. Do not operate this Test Set with the Case Assembly open.

SAFETY IDENTIFICATION IN TECHNICAL MANUAL

This manual uses the following terms to draw attention to possible safety hazards that may exist when operating or servicing this equipment:

WARNING: Identifies conditions or activities that, if ignored, can result in personal injury or death.

Caution: Identifies conditions or activities that, if ignored, can result in equipment or property damage, e.g., Fire.

SAFETY SYMBOLS IN MANUALS AND ON UNITS



WARNING:

Indicates a Toxic hazard. Item should only be handled by Qualified Service Personnel. Dispose of item in accordance with local regulations.



WARNING:

Indicates a Fire hazard.



Caution: ESD

Indicates item is static sensitive.

SAFETY FIRST - TO ALL OPERATIONS PERSONNEL (cont)



Caution:

Refer to accompanying documents. (This symbol refers to specific CAUTIONS represented on the unit and clarified in the text.)



Caution: AC TERMINAL:

Terminal that may supply or be supplied with AC or alternating voltage.

EQUIPMENT GROUNDING PROTECTION

Improper grounding of equipment can result in electrical shock.

USE OF PROBES

Refer to Performance Specifications for the maximum voltage, current and power ratings of any connector on the Test Set before connecting a probe from a terminal device. Be sure the terminal device performs within these specifications before using the probe for measurement, to prevent electrical shock or damage to the equipment.

POWER CORDS

Power cords must not be frayed or broken, nor expose bare wiring when operating this equipment.

USE RECOMMENDED FUSES ONLY

Use only fuses specifically recommended for the equipment at the specified current and voltage ratings. Refer to Performance Specifications for fuse requirements and specifications.

INTERNAL BATTERY

This unit contains a Lithium Ion Battery, and can be replaced by an operator.

EMI (ELECTROMAGNETIC INTERFERENCE)



Caution:

Signal Generators can be a source of Electromagnetic Interference (EMI) to communication receivers. Some transmitted signals can cause disruption and interference to communication service out to a distance of several miles. User of this equipment should scrutinize any operation that results in radiation of a signal (directly or indirectly) and should take necessary precautions to avoid potential communication interference problems.

SAFETY FIRST - TO ALL OPERATIONS PERSONNEL (cont)

TOXIC HAZARDS

**WARNING: Lithium**

A Lithium battery is used in this equipment.

- Lithium is a toxic substance so the battery should in no circumstances be crushed, incinerated or disposed of in normal waste.
- Do not short circuit or force discharge since this might cause the battery to vent, overheat or explode.

FIRE HAZARD

**WARNING:**

Make sure that only fuses of the correct rating and type are used for replacement. If an integrally fused plug is used on the supply lead, ensure that the fuse rating is commensurate with the current requirements of this equipment.

INPUT OVERLOAD

**Caution:**

- UUT:RX port maximum reverse power 100 mW.
- UUT:TX port maximum power 300 W peak, 5 W average.

ERGONOMICS

**WARNING: Heavy Object**

When the transit case is fully-loaded, the ALT-9000 Test Set Kit is a heavy object. Two-person lift required.

SAFETY FIRST - TO ALL OPERATIONS PERSONNEL (cont)

STATIC SENSITIVE COMPONENTS



Caution: ESD

This equipment contains components sensitive to damage by Electrostatic Discharge (ESD). All personnel performing maintenance or calibration procedures should have knowledge of accepted ESD practices and/or be ESD certified.



Service Upon Receipt of Material

Unpacking test set

Customized foam packing material inside the transit case provides maximum protection for the Test Set.

Use the following steps to unpack the Test Set Kit:

STEP	PROCEDURE
1.	Cut sealing tape on top of the shipping container. Open shipping container.
2.	Remove transit case from shipping container.
3.	Place transit case on a flat, clean, and dry surface.
4.	Locate the packing slip on the exterior of the shipping container (used when Checking Unpacked Equipment).
5.	Open the transit case (see Fig. 1).
6.	Remove items from the transit case (see Fig. 2).

Checking Unpacked Equipment

Identify and inspect equipment for possible damage incurred during shipment. If Test Set has been damaged, report the damage to VIAVI Customer Service.



Fig. 1 Fully-Packed Transit Case



Fig. 2 Unpacked Items¹

The packing slip identifies the details of the purchased configuration and purchased options. Report all discrepancies to VIAVI.

Review packing slip to verify shipment is complete. Refer to [Fig. 2](#), [Fig. 4](#), and [Table 1](#) for help with item identification.

Verify the test set configuration and serialized components; see [Fig. 3](#).

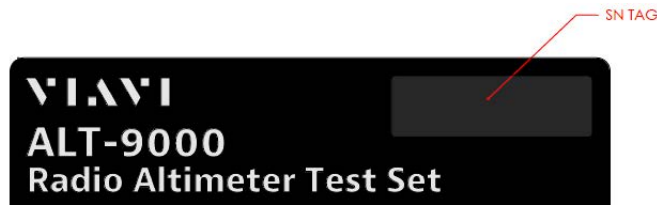

Fig. 3 Placard on Transit Case (serialized)

1. Optional Battery Pack shown in photo. The instrument is shipped with a Battery Pack installed in the unit. The 'tackle box' and 12-inch cable(s) are not shown in this photo.

RELATED INFORMATION

Viavi maintains a webpage where additional product information is available to customers:

- <https://www.viavisolutions.com/ALT-9000>

Use this manual in conjunction with the following information:

- **Getting Started Guide:** provides the basics of setup and use.
- **Maintenance Manual:** provides guidance for approved maintenance and troubleshooting procedures.
- **Remote Command Interface Guide:** provides details on remote commands and syntax.
- **Product Brochure:** provides ordering information for parts and accessories.
- **Data Sheet:** provides technical specifications.

TEST SET KIT CONFIGURATIONS

There are two configurations; ALT-9000 (P/N 22145341) and ALT-9000B (P/N 22162529). Refer to [Fig. 4](#) and [Table 1](#) for configuration details.

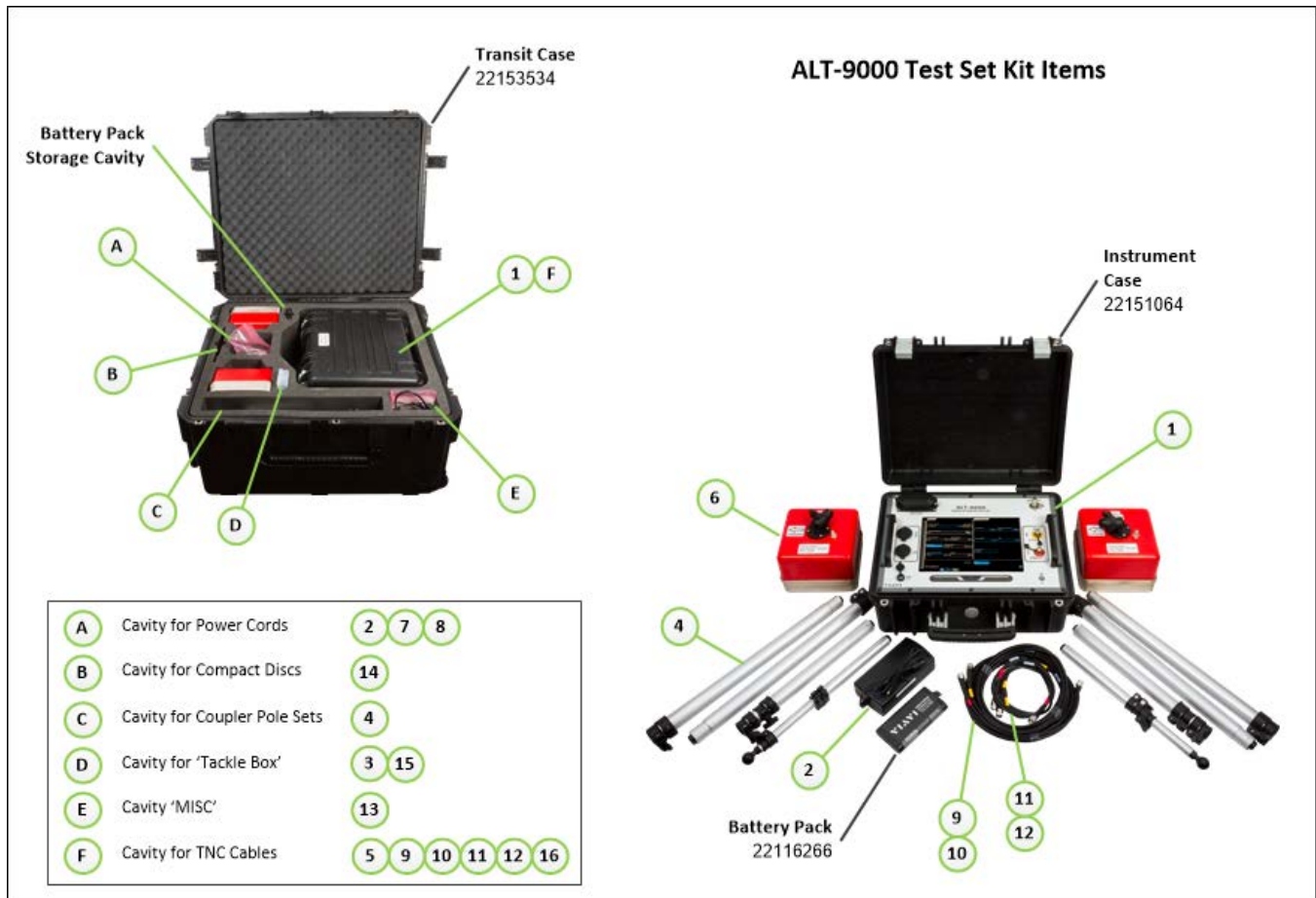

Fig. 4 Kit Items

Kit Components

Table 1 Kit Components

#	ITEM		P/N	ALT-9000 (22145341)	ALT-9000B (22162529)
1	ALT-9000 Test Set (battery included)		22151020	1	1
2	Power Supply		67374	1	1
3	Adapter, TNC-TNC		38353	2	2
4	Antenna Coupler Pole Set		139152	2	2
5	Cable, TNC-TNC, 12" (Loop Back)		62401	1	1
6	Antenna Couplers		139139	2	2
7	Power Cord, US		62302	1	1
8	Power Cord, European		64020	1	1
9	Coax, TNC-TNC, yellow 4'		22153321	1	1

Service Upon Receipt

#	ITEM		P/N	ALT-9000 (22145341)	ALT-9000B (22162529)
10	Coax, TNC-TNC, red 4'		22153326	1	1
11	Coax, TNC-TNC, yellow 20'		22153329	1	1
12	Coax, TNC-TNC, red 20'		22153332	1	1
13	Getting Started Guide (paper)		22149658	1	1
14	Operator Documentation (CD) <ul style="list-style-type: none"> • Operation Manual • Getting Started Guide • RCI Guide 		22149666	1	1
15	Attenuator, fixed 20 dB		112036	2	2
16	Cable Assy; TNC RA; Keyed; 12 inch		22162292		1
	Antenna Coupler Labels		111838 (consumable)	1	1
	Transit Case		22153534	1	1

Standard Accessories

ITEM		PART NUMBER	QTY
'Tackle Box' Case	Fig. 5	FBPP-GC-6	1



Fig. 5 'Tackle Box' Case
(shown with items 3 and 15)

Optional Accessories

ITEM		PART NUMBER	QTY
Battery Pack		22116266	1
Maintainer Documentation (CD) <ul style="list-style-type: none"> Maintenance Manual 		22145346	1

Table of Contents

Chapter 1 - Description	1 - 1
Introduction ALT-9000	1 - 1
Scope	1 - 1
Nomenclature Cross-Reference List	1 - 1
Equipment Capabilities and Features	1 - 1
Capabilities	1 - 2
Features	1 - 2
Utilities	1 - 2
Chapter 2 - Test Set Operation	2 - 1
Introduction	2 - 1
Power Requirements	2 - 1
Installation	2 - 2
Controls and Connectors	2 - 4
Front Panel Controls	2 - 3
Front Panel Connectors	2 - 5
Operating Procedures	2 - 6
Power ON	2 - 6
Power OFF	2 - 6
User Interface Components	2 - 6
Launch Bar and Function Keys	2 - 6
Function Window Icons	2 - 9
Defining Parameters	2 - 9
Chapter 3 - Test Set Functions	3 - 1
Introduction	3 - 1
Test Set Functions	3 - 1
Simulation	3 - 1
Profile Setup	3 - 6
Test Setup	3 - 13
Self Test	3 - 21

Chapter 4 - Testing 4 - 1

Introduction 4 - 1
Connection 4 - 3
Setup 4 - 9
Tests 4 - 12
Identifying Installed Software Version 4 - 20

Chapter 5 - Maintenance 5 - 1

General 5 - 1
 Tool Requirements 5 - 1
Inspections 5 - 2
Cleaning 5 - 2
Component Maintenance 5 - 3
 Battery Replacement 5 - 3
Software Maintenance 5 - 7
 ALT-9000 Software Update 5 - 7

Chapter 6 - Product Specifications 6 - 1

Appendix A - Abbreviations A - 1

Appendix B - Terminology B - 1

List of Figures

TITLE	PAGE
Fig. 1 Fully-Packed Transit Case	ix
Fig. 2 Unpacked Items	x
Fig. 3 Placard on Transit Case	x
Fig. 4 Kit Items	xi
Fig. 5 'Tackle Box' Case	xiv
Fig. 1-1 VIAVI ALT-9000	1 - 1
Fig. 2-1 AC Adapter	2 - 1
Fig. 2-2 Front Panel Control/Indicator Bar	2 - 3
Fig. 2-3 Front Panel Controls and Connectors	2 - 5
Fig. 2-4 Launch Bar and Function Keys	2 - 6
Fig. 2-5 Launch Bar Appears In Front of Function Window	2 - 7
Fig. 2-6 Simulation Function Window	2 - 8
Fig. 2-7 Numeric Keypad	2 - 9
Fig. 2-8 Data Slew Bar	2 - 10
Fig. 2-9 Rotary Knob	2 - 10
Fig. 2-10 AlphaNumeric Keyboard Control	2 - 11
Fig. 2-11 Drop-down Menu (Selectable Units)	2 - 11
Fig. 2-12 Locked Field	2 - 12
Fig. 3-1 Simulation Function Window (Simulation: Manual)	3 - 1
Fig. 3-2 Simulation Function Window (Simulation: Profile)	3 - 2
Fig. 3-3 Radio Altimeter Test Function Window Pulse	3 - 5
Fig. 3-4 Profile Setup Function Window	3 - 6
Fig. 3-5 Edit Leg # Window	3 - 9
Fig. 3-6 Manage Profiles Window (Store Profile)	3 - 10
Fig. 3-7 Manage Profiles Window (Store Name Entry)	3 - 10
Fig. 3-8 Manage Profiles Window (Delete Profile)	3 - 11
Fig. 3-9 Load Profile Window	3 - 12
Fig. 3-10 General Tab Screen	3 - 13
Fig. 3-11 Loss Tab Screen	3 - 15
Fig. 3-12 Storage Tab Window	3 - 16
Fig. 3-13 Manage Settings Window (Store Settings)	3 - 17
Fig. 3-14 Manage Settings Window (Store Name Entry)	3 - 17
Fig. 3-15 Manage Settings Window (Delete Settings)	3 - 18

TITLE	PAGE
Fig. 3-16 Load Settings Window (Recall Settings)	3 - 18
Fig. 3-17 Storage Tab Window (Factory Reset)	3 - 19
Fig. 3-18 Display Tab Window	3 - 20
Fig. 3-19 Self Test Screen	3 - 21
Fig. 3-20 Self Test Running	3 - 21
Fig. 3-21 Self Test Passed	3 - 22
Fig. 3-22 Status Bar	3 - 22
Fig. 3-23 Alert Message Log	3 - 23
Fig. 4-1 ALT-9000 Antenna Coupler	4 - 1
Fig. 4-2 Pole #1	4 - 1
Fig. 4-3 Extension Pole #2	4 - 1
Fig. 4-4 Extension Pole #3	4 - 1
Fig. 4-5 Extension Pole #4	4 - 2
Fig. 4-6 Low Loss RF Coax Cable, 20 ft.	4 - 2
Fig. 4-7 Low Loss Coax Cable, 4 ft	4 - 2
Fig. 4-8 Jumper RF Coax Cable	4 - 2
Fig. 4-9 Attenuator, fixed 20 dB	4 - 2
Fig. 4-10 Direct Connection	4 - 3
Fig. 4-11 ALT-9000 RF Connections	4 - 4
Fig. 4-12 ALT-9000 RF Connections (Feeders)	4 - 6
Fig. 4-13 ALT-9000 Coupler Connection	4 - 7
Fig. 4-14 ALT-9000 Antenna Coupler Installed	4 - 8
Fig. 4-15 Delay Calibration Screen	4 - 9
Fig. 4-16 Altitude Pause Key	4 - 11
Fig. 4-17 Paused Altitude Rate / Manual Altitude Slew	4 - 12
Fig. 4-18 Multi-leg Profile Example	4 - 15
Fig. 4-19 UUT Parameters	4 - 17
Fig. 4-20 Options Function Window	4 - 19
Fig. 5-1 Locator View, Coin Battery	5 - 3
Fig. 5-2 Locator View, Primary Battery	5 - 3
Fig. 5-3 Primary Battery Port	5 - 4
Fig. 5-4 Battery Housing Screw	5 - 5
Fig. 5-5 Battery Backup Access	5 - 5
Fig. 5-6 USB Ports	5 - 7
Fig. 5-7 System Config - Status	5 - 8
Fig. 5-8 System Config - Hardware	5 - 10
Fig. 5-9 System Config – UI Options	5 - 11
Fig. 5-10 System Config – Network	5 - 12

TITLE	PAGE
Fig. 5-11 System Config – Date/Time	5 - 13
Fig. 5-12 Maintenance Function Window	5 - 13
Fig. 5-13 Transmit Function	5 - 14
Fig. 5-14 Receive Diagnostics	5 - 15
Fig. 5-15 Tx Attens	5 - 16
Fig. 5-16 Loopback	5 - 17
Fig. 5-17 Pass Thru	5 - 18
Fig. 5-18 System Info	5 - 19

THIS PAGE INTENTIONALLY LEFT BLANK.

List of Tables

TITLE	PAGE
Table 1 Kit Components	xiv
Table 2 Standard Accessories	xvi
Table 3 Optional Accessories	xvi
Table 2-1 Function Window Icons	2 - 9
Table 2-2 Numeric Keypad Icons	2 - 10
Table 5-1 Procedure Level	5 - 1
Table 5-2 Remove/Install Tool Requirements	5 - 1
Table A-1 Abbreviations	A - 1
Table B-1 Terminology	B - 1

THIS PAGE INTENTIONALLY LEFT BLANK.

Description

1

1.1 INTRODUCTION ALT-9000



Fig. 1-1 VIAVI ALT-9000

1.1.1 Scope

Type of Manual: Operation Manual

Equipment Name and Model Number: ALT-9000 Radio Altimeter Flight-line Test Set.

Equipment Uses: Testing FMCW, CDF FMCW, and Pulse Radio Altimeters.

1.1.2 Nomenclature Cross-Reference List

Common Name: ALT-9000

Official Nomenclature: Radio Altimeter Flight-line Test Set.

1.2 EQUIPMENT CAPABILITIES AND FEATURES

ALT-9000

The ALT-9000 is a single channel tester, designed for testing FMCW and Pulse Radio Altimeters in the flight-line environment. The ALT-9000 quickly connects to the Radio Altimeter via two antenna couplers.

The test set can also simulate altitude and altitude rate to verify decision heights and altitude trips for auto-land systems and altitude data feed to EGPWS.

The user interface is windows based and provides various pages for control of the test set and display of parametric measurements including TX power, TX Frequency (center), Sweep Rate, TX pulse width and TX PRF (pulse systems).

Ratiometric Test

RF Level may be set manually for specific receiver sensitivity measurement or Auto RF Level mode sets an RF Level based on TX Power - Height Path Loss - Scattering Loss. This ensures that the test environment replicates the actual airborne conditions, verifying T/R loop gain and allowing antenna bonding issues (TX-RX cross leakage) to be identified. An additional RF Level offset figure may be set to ensure an altitude sweep passes with a predetermined gain margin.

Transit Case

The ALT-9000 is shipped inside of a rugged transit case which also provides storage for the accessories; AC-DC Power Supply/Charger, External Battery Charger, Antenna Couplers, Coupler Poles, RF Coax Cables, Power Cords, Operation Manual CD and Getting Started Manual.

1.2.1 Capabilities

The ALT-9000 provides users with the following standard capabilities:

- Test FMCW Radio Altimeters, including CDF Types
- Test Pulse Radio Altimeters
- Direct connect to UUT T/R or to installed system via Antenna Couplers

1.2.2 Features

- Ratio-metric RF loop test allows TX, RX, Antenna or Feeder faults (to be identified).
- Programmable multi-leg Climb/Descend profiles
- Large touch screen 12 in display, with simple user interface
- Remote Control Interface LAN
- Lightweight and compact, 31 lbs. (14 kg)
- Battery 4 hours plus duration
- Changeable battery
- Radio Altimeter Test Functional Window

1.2.3 Utilities

- Software Upgrade
- Operational Status
- Setup

Test Set Operation

2

2.1 INTRODUCTION

This chapter refers to local operation of an ALT-9000 configured with factory default settings, unless otherwise specified. New Test Sets are configured to start in the factory default setting. Review Installation and Power Requirements before using the Test Set.

2.2 POWER REQUIREMENTS

2.2.1 Power

The ALT-9000 is powered by a removable Lithium Ion Battery. The battery charging circuit enables the operator to recharge the battery anytime the unit is connected to the AC Adapter. The ALT-9000 can operate continuously utilizing the AC Adapter (Fig. 2-1). The internal battery is equipped to power the ALT-9000 for four continuous hours of use.

AC Power Requirements

The AC Adapter, supplied with the ALT-9000, operates over a voltage range of 100 to 250 VAC at 47 to 63 Hz. The battery charger operates whenever DC power (11 to 32 Vdc) is applied to the Test Set with the supplied AC Adapter or a suitable DC power source.

**Note:**

If the supply voltage is <11 V, the unit will switch automatically to internal battery. If the voltage is >32 V, a 5 Amp resettable thermal fuse on the DC input port will open, protecting the test set. Reset fuse by disconnecting and reconnecting the power cord to the unit.

When charging, the battery reaches 100% charge in approximately four hours. The battery could remain in trickle mode for several hours if the battery is completely discharged. The Battery Charging temperature range is 0° to 45° C, controlled by an internal battery charger.



Fig. 2-1 AC Adapter

2.2.2 Battery Recharging Using External Power Supply

Perform the following steps to recharge the battery using an external power supply:

STEP	PROCEDURE
1.	Connect AC Line Cable to AC POWER Connector on the AC Adapter and an appropriate AC power source.
2.	Connect the AC Adapter DC output to the DC POWER Connector on the ALT-9000.
3.	Verify the BATT LED is flashing green.
4.	Allow four hours for battery charge or until the BATT LED is steady green. Refer to 2.4.1 for additional battery indicators.

2.3 INSTALLATION

2.3.1 No Installation Required

The ALT-9000 does not require installation to be used. It is designed for use in its transit case, opened so that the front panel is accessible to the operator.

2.3.2 Ventilation Requirements

The ALT-9000 is convection cooled by the enclosure case. Avoid standing the Test Set on or close to other equipment that is hot.

2.3.3 Bench Installation

The Test Set can be placed on flat benchtop in an electronics testing / lab environment.



Caution:

To avoid damage to touch screen, do not stack other equipment on top of the test set.

2.4 CONTROLS AND CONNECTORS

2.4.1 Front Panel Controls

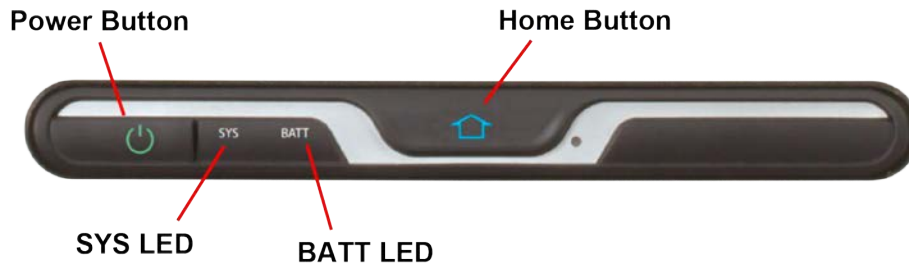

Fig. 2-2 Front Panel Control/Indicator Bar

Control	Description
Power	The Power Button is used to power the Test Set on and off.
SYS LED	This LED indicates status for the system: <ul style="list-style-type: none"> Powered On (steady green) Indicates the unit is in an operational status. Failure (steady red) Some form of failure has occurred which precludes using the display to indicate the problem (e.g. main processor failure, power supply fault, etc.). Boot (flashing blue) Unit is booting and is not yet able to indicate status on the display (during initial OS and application load). Off/Standby (steady orange) Unit is off, but power is supplied to the power supply from the AC power supply. Off without External Supply (off) Unit is off, no external power supplied.
Home	Pressing and holding the Home Button for 5 sec sets the backlight to maximum brightness.

Control	Description
BATT LED	<p>This LED indicates status for the battery:</p> <p>Battery Voltage Low (steady red) The unit turns off within one minute without charger.</p> <p>Battery Pre-Charge (flashing yellow) Trickle charge during extremely low voltage on the battery.</p> <p>Battery Charging (flashing green) Charge in progress.</p> <p>Battery Fully Charged (steady green) AC Adapter is holding battery at full charge.</p> <p>Battery Temperature Extreme (steady blue) Temperature <0° C or >45° C can't charge battery.</p> <p>Battery Error (steady red) Problem with the battery or charging system.</p> <p>Battery Missing (Off) AC applied without battery in place.</p> <p>Normal Operation (Off) Operating on battery with AC Adapter not connected.</p> <p>Test Set Off (Off) Test Set is turned off with AC Adapter not connected.</p> <p>Battery Suspended Charge (flashing red) AC applied with battery charging suspended.</p>

2.4.2 Front Panel Connectors

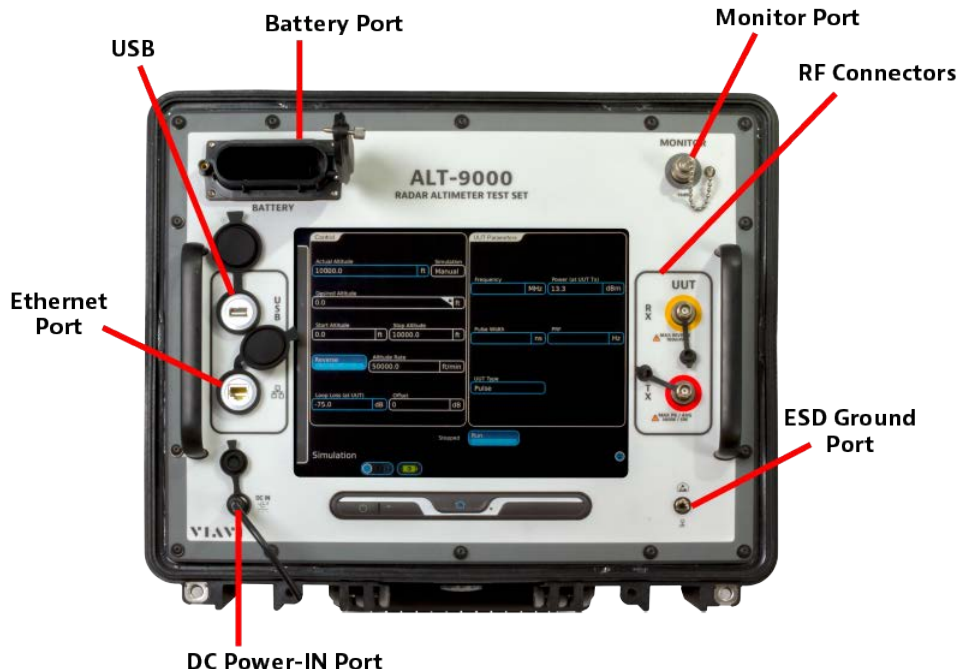

Fig. 2-3 Front Panel Connectors

Table 2-1

Connector	Description
Battery Port	Provides access to and connectivity for the Battery Pack.
USB	USB 2.0 connection that allows connection of USB devices (e.g. a USB memory stick or Network connectors). Recommended USB memory device is VIAVI PN 67327.
Monitor Port	The monitor port allows the operator to take a sample (spectrum measurements or pulse shape readings) of the transmitted waveform from the UUT while the device is being tested. The output of the monitor port is -33 dBc from the UUT output power. This is uncommon for normal use but may be beneficial for UUT development or troubleshooting.
RF Connectors	UUT:RX -- TNC Connector -- 100 mW MAX REVERSE -- RF output for direct connection or antenna coupler. Connects to UUT:RX. UUT:TX -- TNC Connector -- 300 W PK 5 W AVG -- RF input for direct connection or antenna coupler.
Ethernet Port	Standard Base T RJ45 connection. 10/100 Mbps. This connection can be used for software upgrades and for remote operation.
DC Power-IN Port	11 to 32 Vdc external power and battery charge.
ESD Ground Port	Provides connectivity to ALT-9000 chassis ground for grounding to aircraft/earth ground.

2.5 OPERATING PROCEDURES

Power ON Test Set

After completing Initial Installation, perform the following steps to Turn On the Test Set:

STEP	PROCEDURE
1.	Press Power button on Front Panel for a minimum of 1 second to power on Test Set. The Power Up screen is displayed when the unit is first powered on. The Power Up window displays a load progress bar at the bottom of the screen.

Power OFF Test Set

Perform the following steps to power off the Test Set:

STEP	PROCEDURE
1.	Press Power button on Front Panel for a minimum of 0.25 seconds. A prompt is displayed, asking if the user would like to power down the unit.

2.6 USER INTERFACE COMPONENTS

The Test Set User Interface (UI) is a touch screen control panel that provides a flexible working environment for users. The UI utilizes maximized Function Windows i.e. one function window occupies the whole screen area. The UI is navigated locally i.e. using the Front Panel Touch Screen.

2.6.1 Launch Bar and Function Keys

The Launch Bar (Fig. 2-4) is a vertical gray bar located at the left side of the Test Set UI.

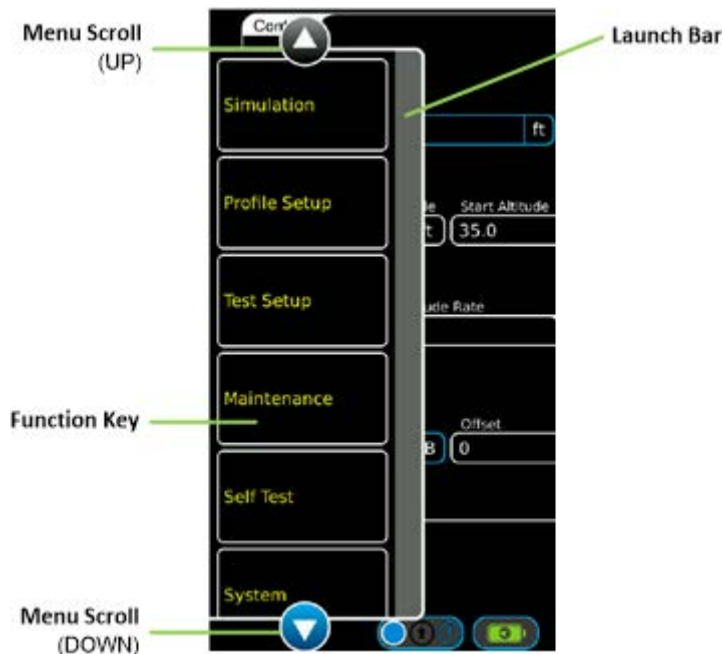

Fig. 2-4 Launch Bar and Function Keys

Touching the Launch Bar opens and closes a vertical scrolling menu, providing access to the Function Keys (Fig. 2-4). The menu must be open to access the Function keys.

Each Function Key opens a unique function window:

- Simulation see Section 3.2
- Profile Setup see Section 3.3
- Test Setup see Section 3.4
- Maintenance see Section 5.5.2
- Self Test see Section 3.5
- System see Section 5.5.1

When opened, the Launch Bar menu appears in front of any function windows currently occupying that area of the display (Fig. 2-5). Touch the Launch Bar to close the menu and view the entire Function Window.

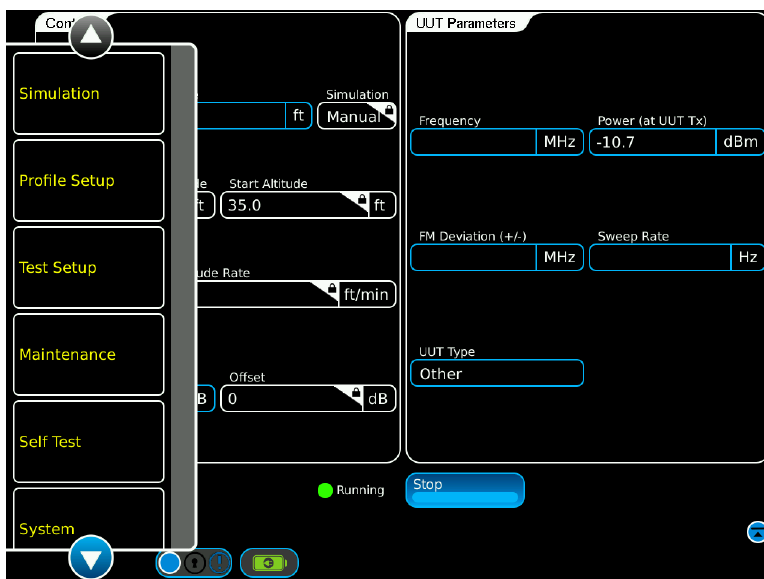

Fig. 2-5 Launch Bar Appears In Front of Function Window

2.6.2 Simulation Function Windows

Simulation Function Windows provide visual access to the Test Set’s control parameters and displayed data.

Function	How to
<p>Opening/Closing Function Windows</p>	<p>Simulation Function Windows are opened by selecting the Function Icon from the Launch Bar. Function Windows are closed by selecting the blue circle icon at the bottom right of the window, or by selecting a new function window.</p> <p>Only one function window may be open at a time.</p>

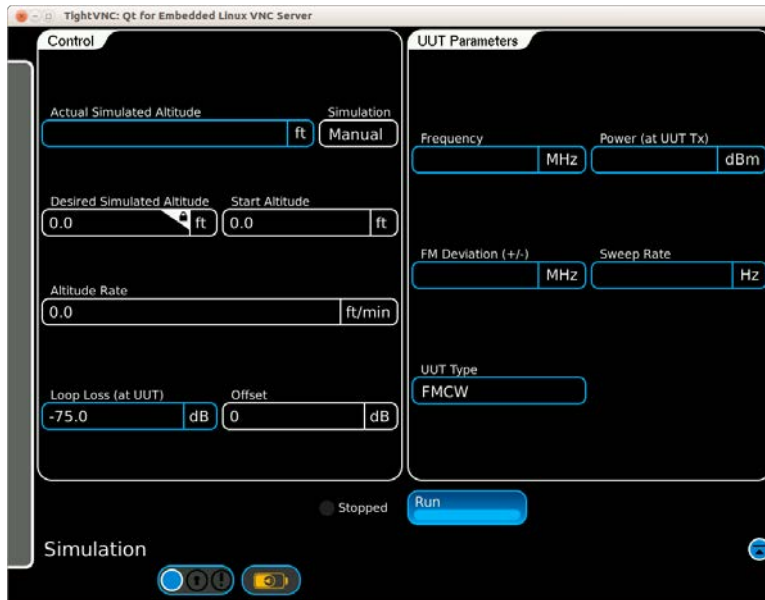

Fig. 2-6 Simulation Function Window

2.6.3 Function Window Icons

Function Windows use the following icons to indicate various functions or states:

ICON	DESCRIPTION
	Closes the Function Window while leaving the function in the Active State.
	Maximizes Function Window or opens Status Bar.
	Minimizes Function Window or closes Status Bar.
	Displays Detecting and a yellow circle when detecting the type of radio altimeter under test.
	Displays Running and a green circle when the simulation is running.
	Displays Stopped and a gray circle when the simulation is stopped.
	Displays the remaining battery capacity in %.

Table 2-2 Function Window Icons

2.7 DEFINING PARAMETERS

2.7.1 Entering Numeric Values

Numeric values are used to define a variety of test parameters such as frequency and level. When a numeric data field is selected for editing, a group of data entry pop-up windows is launched which provides three methods for defining the value; Numeric Keypad, Data Slew Bar or Rotary Knob.

2.7.2 Numeric Keypad and Slider Bar

The Numeric Keypad allows the user to enter a specific numeric value. A value is entered by pressing the numbers on the keypad. The value is enabled by pressing the unit of measurement on the Numeric Keypad window.



Fig. 2-7 Numeric Keypad





Icon	Description
	Pressing Cancel voids any un-entered changes and closes the group of data entry pop-up windows.
	Pressing Clear ignores the current entry, allowing a new value to be entered.
	Pressing Backspace deletes the last digit in the numeric value.
	Pressing Next Value Selection replaces the Numeric Keypad with the Rotary Knob. Press the Next Value Selection again and the Rotary Knob is replaced with the Slew Data Bar. Press again and the Numeric Keypad appears.

Table 2-3 Numeric Keypad Icons

2.7.3 Data Slew Bar

For some data-entry fields, a data slew bar is available. When displayed, the operator can use the Data Slew Bar to incrementally adjust data values by sliding the bar.



Note:

To use the 'up' and 'down' buttons on the Slew Bar, buttons must be pressed and held for a few seconds.

Selecting x10 increases the step increment by a factor of 10. Selecting /10 decreases the step increment by a factor of 10. Selecting Enter closes the Data Slew Bar.



Fig. 2-8 Data Slew Bar

2.7.4 Rotary Knob

The Rotary Knob is used to slew values up or down. Selecting x10 increases the step increment by a factor of 10. Selecting /10 decreases the step increment by a factor of 10. Selecting Enter closes the Rotary Knob,

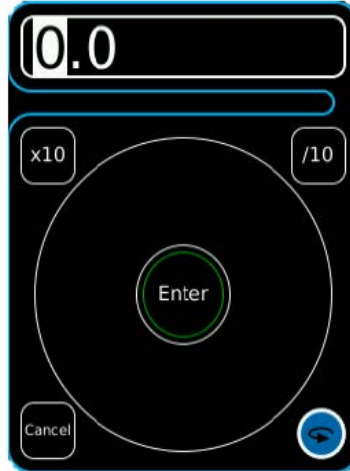

Fig. 2-9 Rotary Knob

2.7.5 AlphaNumeric Keyboard Control

Allows the user to enter Alphabetical and Numeric characters.

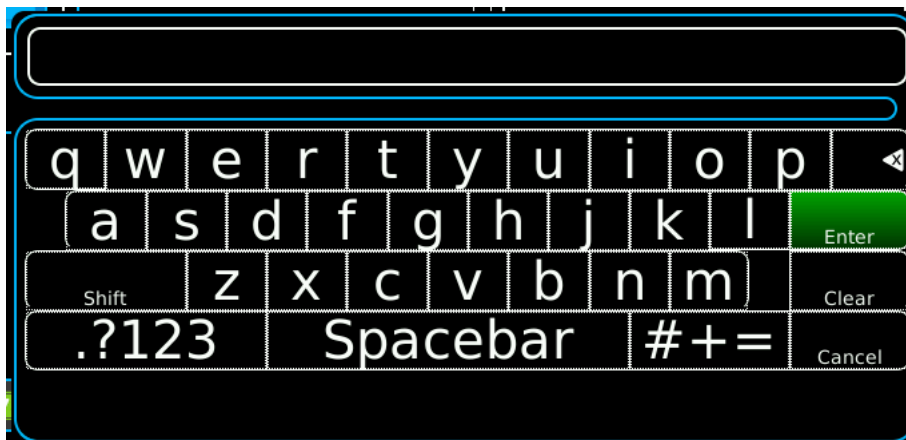

Fig. 2-10 Keyboard Control

2.7.6 Drop-down Menus

Drop-down Menus are used to list pre-defined variables. Selecting a Drop-down Menu opens the list of variables available for that field. The variable currently selected is displayed on the menu as a white label on a blue background (Fig. 2-11). Drop-down Menus can be dragged up and down on the display in order to view long lists.

2.7.7 Selectable Units

Some fields may have selectable units. For those fields identified, select the units field and a drop-down menu is displayed.



Fig. 2-11 Drop-down Menu (Selectable Units)

2.7.8 Locked Fields

A small padlock symbol may be displayed against certain fields indicating that the field is locked and may not be edited or accessed (Fig. 2-12).

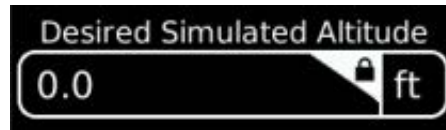

Fig. 2-12 Locked Field

NOTE: The Desired Simulated Altitude field is locked because it can only be modified when a manual simulation is running, then paused.

Test Set Functions

3

3.1 INTRODUCTION

This chapter provides an operational description of standard simulator functions.

3.2 SIMULATION

The Simulation Function Window is the main test screen and is used to control the altitude rate, simulation type, start /stop altitudes, and RF return level. UUT Type is auto-select only. UUT:TX Frequency and Power are displayed. Sweep Rate and FM Deviation are displayed for FMCW types, with PRF and Pulse width displayed for pulse types.

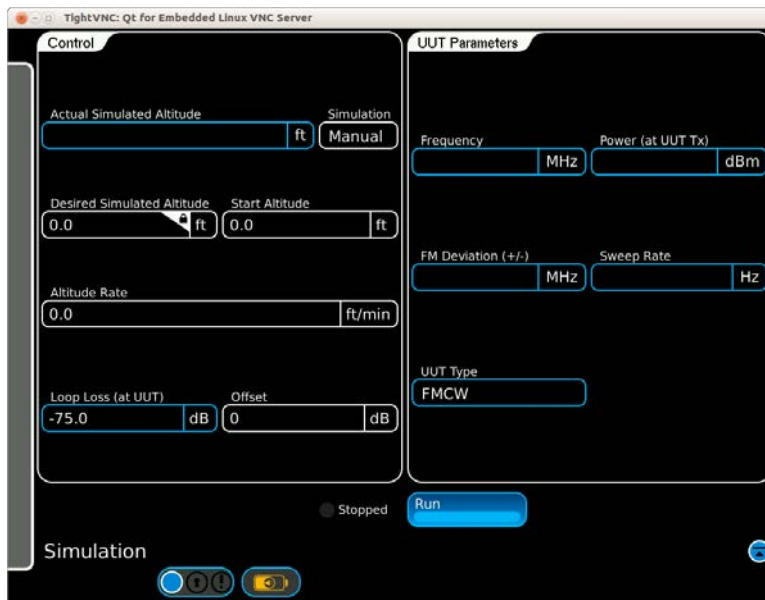

Fig. 3-1 Simulation Function Window (Simulation: Manual)

3.2.1 Auto RF Level Test

TX power can vary considerably between different designs. Sufficient loop gain exists in the system to provide altitude tracking over the operational range of the radio altimeter, typically -20 to between 5,000 and 8,000 ft.

FMCW Radio Altimeter specifications generally do not provide receiver sensitivity figures. Many radio altimeter designs adjust receiver sensitivity in proportion to height i.e. decreasing sensitivity at the lower altitudes to avoid noise and multipath tracking problems. Although the ALT-9000 can measure receiver sensitivity and TX power, this is useful only where the installed system specification is known, including the antenna feeder losses.

The ALT-9000 Auto RF Level mode adopts a loop gain or Ratio-Metric approach to test overall system functionality by setting a RF return level that is proportional to the receiver TX power, taking into account the path loss and scattering loss that would normally occur if the 4.3 GHz signal were reflecting off the ground.

By introducing an offset to this RF return level (reducing the return signal by a user set figure in dBs), an altitude sweep that tracks and does not flag throughout its complete range is a positive end to end test and confirmation that the Radio Altimeter will function in the real world environment with a safety margin included.

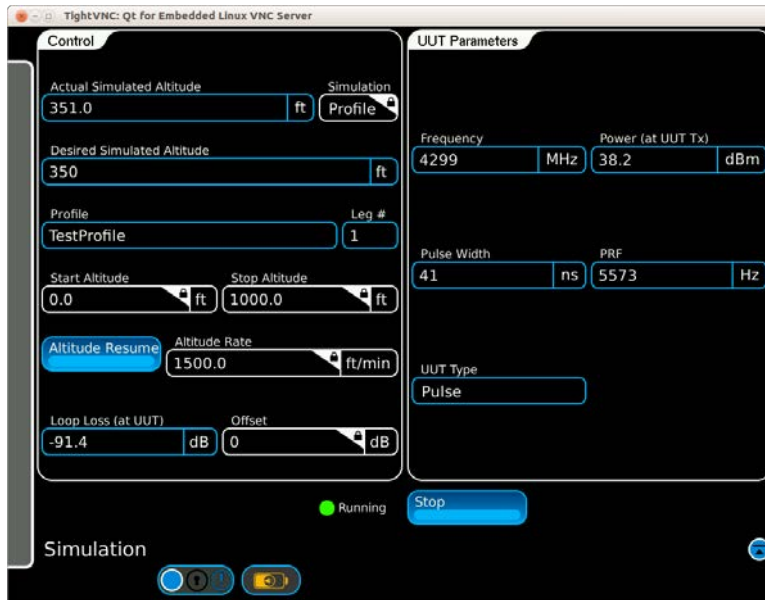

Fig. 3-2 Simulation Function Window (Simulation: Profile)

Display Component	Description
Sweep Rate	Displays TX FM Sweep Rate. Resolution 1 Hz.
FM Deviation	Displays TX FM deviation in MHz. Resolution 1 MHz.
Power	Displays measured TX Power in watts, milliwatts or dBm. Resolution 1 mW.
Frequency	Displays measured TX Center Frequency in MHz. Resolution 1 MHz.
Actual Simulated Altitude (ASA)	Displays the current altitude simulated by the test set for manual or profile operation. During an altitude simulation, the ASA is the altitude used to determine the accuracy of the altitude displayed by the Radio Altimeter System.

Control Component	Description
UUT Type	Displays the current UUT type (autodetected). Type is Pulse, FMCW, CDF FMCW, or Other.
Profile	Displays current profile name being executed. NOTE: Not displayed when Simulation Field is set to manual.
Leg	Displays the current leg # of the current selected profile. NOTE: Not displayed when Simulation Field is set to manual.
Simulation	Drop down menu provides control of simulation type. Selections are Manual and Profile: <ul style="list-style-type: none"> • MANUAL allows user to enter a Static Altitude, or enter a Start Altitude, Stop Altitude and Altitude Rate in order to execute a linear ramp up or down. • PROFILE runs can be entered and then used or stored for later use. Stored profiles are accessed from the profile page.
Desired Simulated Altitude (DSA)	Numeric Pad. During an altitude simulation, this field will be the same as the Start Altitude until the Altitude Pause button is pressed, and a new DSA is entered. The DSA is the altitude that the user would like to achieve. NOTE: Due to the available path lengths in the ALT-9000, the exact DSA may not be achievable, so the closest achievable altitude will be used and displayed as the ASA. This field is only active during Altitude Pause.
Start Altitude	In Simulation:MANUAL MODE, Start Altitude is entered by the user to determine the desired altitude at the start of a manual altitude simulation. The Start Altitude will be used as the DSA until the Altitude Pause button is pressed, and the user enters a different altitude as the DSA. When the Altitude Resume button is pressed, the DSA will return to the Start Altitude. In Simulation:PROFILE MODE, Start Altitude becomes an advisory field for the current profile leg running. <ul style="list-style-type: none"> • Numeric pad. Range: 0 to 10,000 ft in 5 ft increments. • With optional 15,000 ft coil, range is extended to 16,000 or 25,000 ft. • Altitude can be entered in feet or meters. Non 5 foot entries will be rounded to the nearest 5 foot altitude.
Stop Altitude	In Simulation:MANUAL mode, stop altitude may be entered in feet by the user. In Simulation:PROFILE mode, stop altitude becomes an advisory field for the current profile leg running. <ul style="list-style-type: none"> • Numeric pad. Range: 0 to 10,000 ft in 5 ft increments. • With optional 15,000 ft coil, range is extended to 16,000 or 25,000 ft. • Altitude can be entered in feet or meters. Non 5 foot entries will be rounded to the nearest 5 foot altitude.

Control Component	Description
Altitude Rate	<p>Numeric pad. In Simulation:MANUAL mode allows altitude rate to be set in ft/min or ft/s. Range 1 to 120,000 ft/min or 1 to 2,000 ft/s. In Simulation:PROFILE mode becomes an advisory field for current profile leg running.</p> <p>NOTE: Altitude rate may be paused (Altitude Pause Key). In Manual Mode, altitude rate may be reversed (Reverse Key). In Manual Mode, manual slew keys are displayed and allow the user to manually slew the altitude up or down for testing trips, sticking indicator pointers, etc.</p> <p>NOTE: If the number is zero, then the altitude will not transition from the start altitude to the stop altitude and is interpreted as an altitude pause at that altitude for the length of time defined in the profile. If the Altitude Rate is non-zero, then the altitude will change at the rate set. (Number of feet or meters per minute)</p>
Loop Loss	<p>Numeric pad. If Setup functional window Level Mode field is set to AUTO, then this field is advisory. Loop Loss is set proportional to incoming power minus path loss of simulated altitude, minus scattering loss (this has hard limits for high power pulse operation). If Set functional window Level Mode field is set to MANUAL, then user may set Loop Loss within operational range of test set with a resolution 1dBm.</p>
Loop Loss Offset	<p>Numeric pad. This field allows the user to enter a Loop Level offset level in dB. This offset gets added in the Auto Level mode, which establishes a specific loop gain margin for altitude linear ramp tests.</p> <p>NOTE: Radio Altimeter receivers typically change their receiver bandwidth and gain in proportion to height.</p>

Altitude and altitude rate can be entered in units of feet or meters. The test set works exclusively in feet so any value entered in meters will be converted to feet and then converted back to meters. As a result, values entered in meters may change after entry. For instance, upon entering an altitude of 200m, it will be displayed as 199.6m which corresponds to 655 ft.

3.2.2 Pulse Radio Altimeters

The following UUT parameters are displayed when testing pulse radio altimeters:

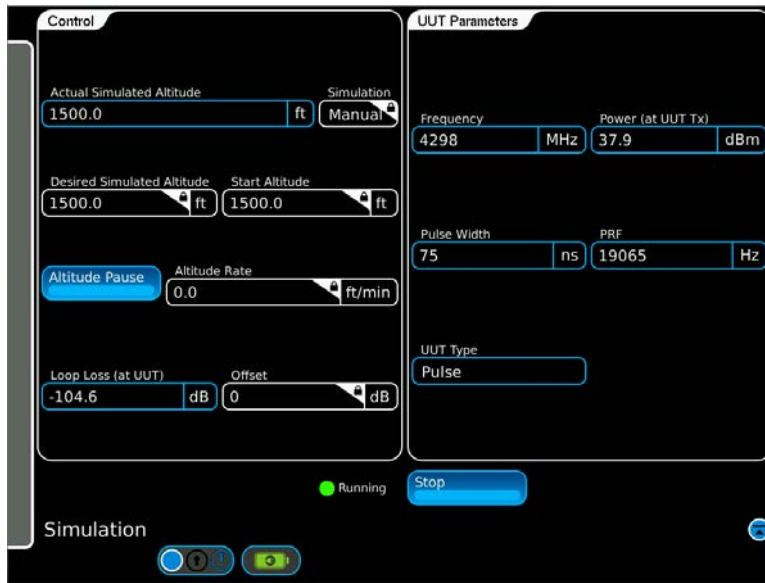

Fig. 3-3 Radio Altimeter Test Function Window Pulse

Display Component	Description
PRF	Displays TX PRF in Hz. Resolution 1 Hz. Value is blank while running a ramp simulation.
Pulse Width	Displays TX pulse width in ns. Value is blank while running a ramp simulation.
Power	Displays measured TX Power in watts, milliwatts or dBm. Resolution: 1 mW.
Frequency	Displays measured TX Center Frequency in MHz. Resolution 1 MHz. Value is blank while running a ramp simulation.



Note:

When simulating altitude ramps, UUT parameters will be blanked. Values will display when the ramp step pauses.

3.3 PROFILE SETUP

The Profile Setup Function Window allows the user to create, save, recall or delete user named profiles. Profiles are used to control dynamic altitude simulations. Each profile is comprised of individual legs which are executed in numeric sequence. Start, stop altitudes and rates are definable for each leg. A profile can then be executed to simulate a complete landing approach including flare out, take-off and departure. Each Profile may consist of up to 20 legs.



Note:

When simulating altitude ramps or profiles legs with altitude rates on pulse altimeters the UUT parameters will be blanked. Anytime the simulated altitude rate returns to zero the UUT parameters will be displayed.

The profile legs are plotted on a chart showing altitude versus time. When the selected profile is running, an aircraft symbol indicates the progress of the simulation on the chart.

The measurement unit for the profile can be changed between feet and meters by clicking on the Profile Display Units field (Test Setup, Display Tab) and using the pop-up menu to change the unit of measurement.

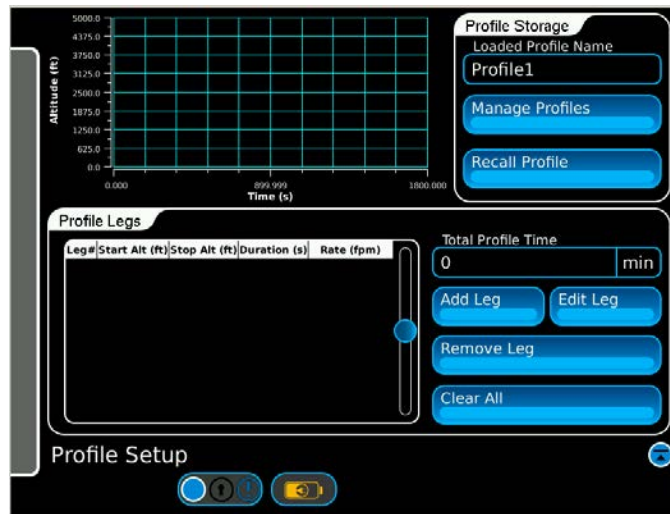

Fig. 3-4 Profile Setup Function Window

Control Component	Description
Add Leg	Displays Add Leg # window.
Edit Leg	Displays Edit Leg # window.
Remove Leg	Deletes the selected leg in the current profile table.
Clear All	Deletes all legs in the current profile table.
Manage Profiles	Displays the Manage Profiles Function Window.
Recall Profile	Displays the Load Profile Function Window.

Functions

Display Component	Description
Loaded Profile Name	Displays current profile name.
Total Profile Time	Displays the total duration of the current profile in minutes.
Leg #	Displays leg number.
Start Alt	Displays Start Altitude. <ul style="list-style-type: none">• Range: 0 to 10,000 ft in 5 ft increments.• With optional 15,000 ft coil, range is extended to 16,000 or 25,000 ft.• Altitude can be entered in feet or meters. Non 5 foot entries will be rounded to the nearest 5 foot altitude.
Stop Alt	Displays Stop Altitude. <ul style="list-style-type: none">• Range: 0 to 10,000 ft in 5 ft increments.• With optional 15,000 ft coil, range is extended to 16,000 or 25,000 ft.• Altitude can be entered in feet or meters. Non 5 foot entries will be rounded to the nearest 5 foot altitude.
Duration (s)	Displays duration of leg in seconds (auto calculated if Altitude Rate is set).
Rate (ft/min)	Displays Altitude Rate in ft/min. Range 1 to 120,000 ft/min.

3.3.1 Add Leg # Window

The Add Leg # Window is used to enter data for new legs in a profile. To create a new leg, select the “Add Leg” line in the profile table to open the Add Leg # window.

3.3.2 Edit Leg # Window

To edit an existing leg, select the desired line in the profile table and select the Edit Leg key to display the Edit Leg # window (Fig. 3-5).



Note:

- When adding a new leg, the Start Altitude field will automatically display an entry equal to the Stop Altitude defined in the previous leg. This may be overwritten to create a step altitude if required. The Altitude Rate may be set for each leg, which will result in an auto calculation for Leg Duration being displayed.
- If level flight is required for a specific leg, set the Start and Stop altitudes to be equal. The Altitude Rate field will be replaced by the Leg Duration field. Enter the required duration of level flight in the Leg Duration field in seconds.

Control Component	Description
Start Altitude	Numeric pad. Enter Start Altitude. <ul style="list-style-type: none"> • Range: 0 to 10,000 ft in 5 ft increments. • With optional 15,000 ft coil, range is extended to 16,000 ft or 25,000 ft. • Altitude can be entered in feet or meters. Non 5 foot entries will be rounded to the nearest 5 foot altitude.
Stop Altitude	Numeric pad. Enter Stop Altitude. <ul style="list-style-type: none"> • Range: 0 to 10,000 ft in 5 ft increments. • With optional 15,000 ft coil, range is extended to 16,000 ft or 25,000 ft. • Altitude can be entered in feet or meters. Non 5 foot entries will be rounded to the nearest 5 foot altitude.
Leg Duration	Numeric pad. Enter duration of leg in seconds or minutes. NOTE: Auto calculated if Altitude Rate is set.
Altitude Rate ft/min	Numeric pad. Enter Altitude Rate in ft/min. NOTE: Replaced by Leg Duration, if level flight is selected i.e. Start Altitude = Stop Altitude.
Enter	Select Enter to confirm leg and close window.

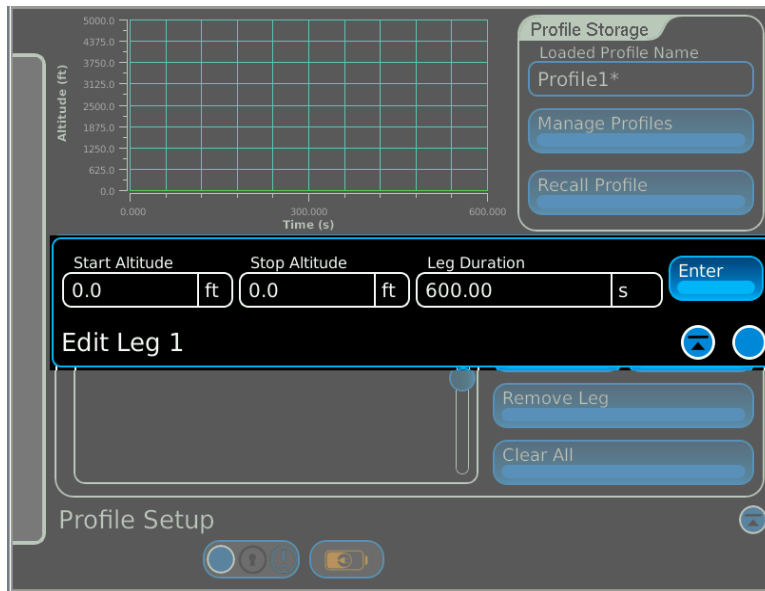

Fig. 3-5 Edit Leg # Window

3.3.3 Manage Profiles

The Manage Profiles control provides named storage and recall for profiles. Each profile consists of up to 20 legs (Fig. 3-6). Profiles are stored in sequence of entry.

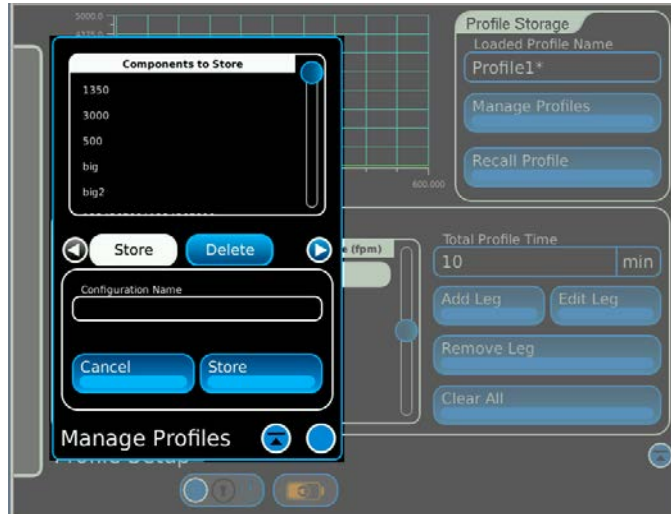

Fig. 3-6 Manage Profiles Window (Store Profile)

The Configuration Name field provides up to 20 characters for the input of a filename. The on-screen keyboard will be removed when the Enter or Cancel keys are hit. Selecting Store key stores the named profile.

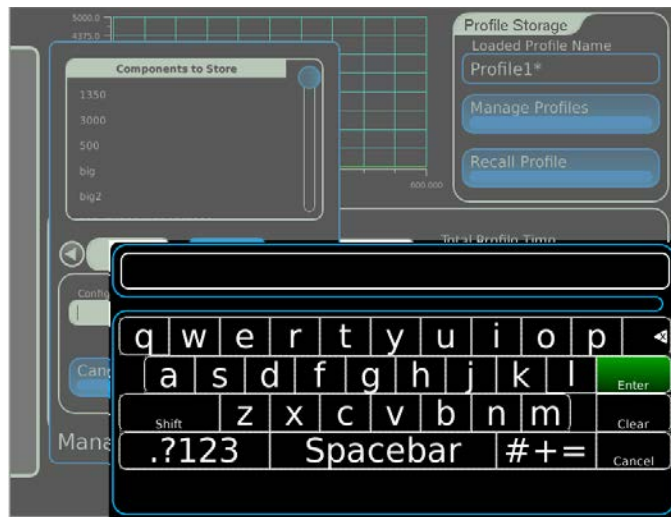

Fig. 3-7 Manage Profiles Window (Store Name Entry)

Press Delete tab to access delete functions in Manage Profiles window.

Select the stored file to be deleted from the Profile Name list.

Press the Delete Store key to delete stored file.

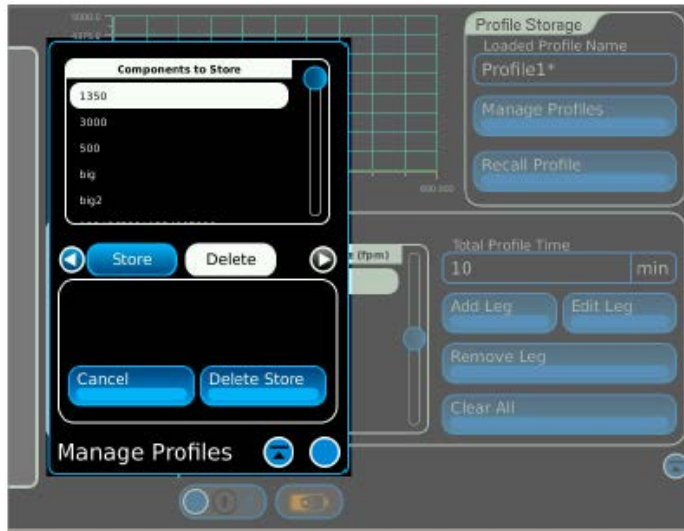

Fig. 3-8 Manage Profiles Window (Delete Profile)

Display Component	Description
Configuration Name	Displays selected profile name. This field is only displayed when the Store button is selected. Allows operator to enter a name for new file to be stored.
Profile Name	Displays list of stored profiles.

Control Component	Description
Delete	Enables files to be deleted. When selected, the Store button toggles to Delete Store.
Store	Enables file to be stored. Stores named profile.
Delete Store	Deletes selected stored file. The Delete Store button toggles to Store when store is selected and toggles back to "Delete Store" when Delete is selected.
Cancel	Cancels storage operation and closes window.
Configuration Name	AlphaNumeric. This field provides up to 20 characters for the input of a filename.

3.3.4 Load Profile Function Window

Selecting the Recall Profile Key displays the Load Profile Function Window. The Load Profile Function Window is used to select and load a stored profile into test set memory for execution (Fig. 3-9).

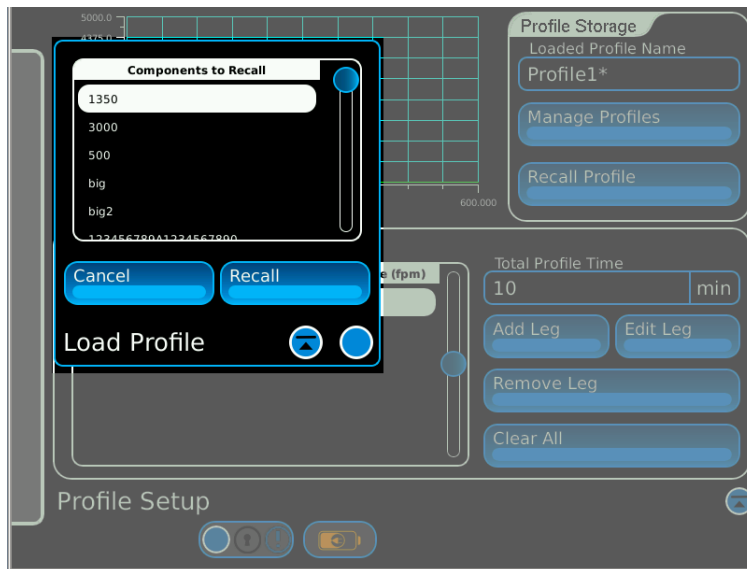

Fig. 3-9 Load Profile Window

Display Component	Description
Profile Name	Displays profile name.

Control Component	Description
Recall	Loads selected profile.
Cancel	Closes the Load Profile Function Window.

3.4 TEST SETUP

The Test Setup Function Window is used to configure the Test Set operational parameters. Fig. 3-10 shows the General Tab Screen. Fig. 3-11 shows the Loss Tab Screen. Fig. 3-12 show the Storage Tab Screen. Fig. 3-18 shows the Display Tab Screen.



Fig. 3-10 General Tab Screen

General Tab Control Component	Description
<p>Level Mode</p>	<ul style="list-style-type: none"> • Auto - RF Level is set proportional to incoming power minus path loss of simulated altitude, minus scattering loss. • Manual - User may set RF level within operational range of test set.
<p>Connection Type</p>	<ul style="list-style-type: none"> • Coupler - For connection via antenna couplers. • Direct - For connection directly to UUT.
<p>Type</p>	<ul style="list-style-type: none"> • FMCW - For conventional FMCW altimeter. • CDF FMCW - For selection of Constant Difference Frequency type altimeter. • Pulse - For Pulse altimeter. • Gated FMCW - For gated FMCW altimeters, e.g., GRA-55 • Other - When the altimeter type being tested can not be determined, when the altimeter exhibits traits from more than one category or is of a completely different method of operation. e.g. CARA.

Functions

General Tab Control Component	Description
Delay Calibration	Displays a Delay Calibration screen with instructions. Connect ends of test cables together using supplied TNC adapter and press this key to automatically calibrate the test set and cable delay. Range: 100 ft length and 10 dB loss per cable. Allows cable with different velocity factors to be used.
Altitude Offset	Range -25 to 100 ft, in 0.5 ft increments. NOTE: If aircraft antenna height from ground at touch down is known, it may be entered in the altitude offset field. NOTE: Path loss compensation is applied proportional to altitude offset in ft when Connection Type = Coupler.

3.4.1 Loss Tab

Loss Tab allows changes to Cable, Coupler Loss and External Attenuation settings. Settings are changed by clicking on the setting entry field.



Fig. 3-11 Loss Tab Screen

Loss Tab Control Component	Description
UUT:TX Cable Loss	Specifies UUT:TX Cable Loss in dB. Range 0 to 9.9 dB.
UUT:RX Cable Loss	Specifies UUT:RX Cable Loss in dB. Range 0 to 9.9 dB.
UUT:TX Coupler Loss	Specifies UUT:TX Antenna Coupler Loss in dB. Range 0 to 19.9 dB.
UUT:RX Coupler Loss	Specifies UUT:RX Antenna Coupler Loss in dB. Range 0 to 19.9 dB.
UUT:TX Ext Attenuation	Specifies UUT:TX External Attenuation in dB. Range 0 to 20.0 dB.
UUT:RX Ext Attenuation	Specifies UUT:RX External Attenuation in dB. Range 0 to 50.0 dB.

3.4.2 Storage Tab

Storage Tab provides named settings file store and recall for all test set settings. Only one settings file may be loaded in memory for use. The number of named settings files that may be stored is only limited by available memory. An alert message will indicate when the memory limit is reached.



Fig. 3-12 Storage Tab Window

Storage Tab Control Component	Description
Loaded Settings Name	Displays name of last settings loaded into test set operational memory.
Manage Settings	Displays Manage Settings Function Window. <ul style="list-style-type: none"> • Settings may be stored. • Saved settings may be deleted.
Recall Settings	Displays Load Settings Function Window. Used to recall and load a saved settings file.
Factory Reset	Resets all settings to factory default.

Selecting the Manage Settings key displays the Manage Settings Function Window (Fig. 3-13). Settings files are stored in sequence of entry.



Fig. 3-13 Manage Settings Window (Store Settings)

Click on the Configuration Name field to access the on-screen keyboard. A 20 character store name may be entered. Selecting Store key stores the named settings.

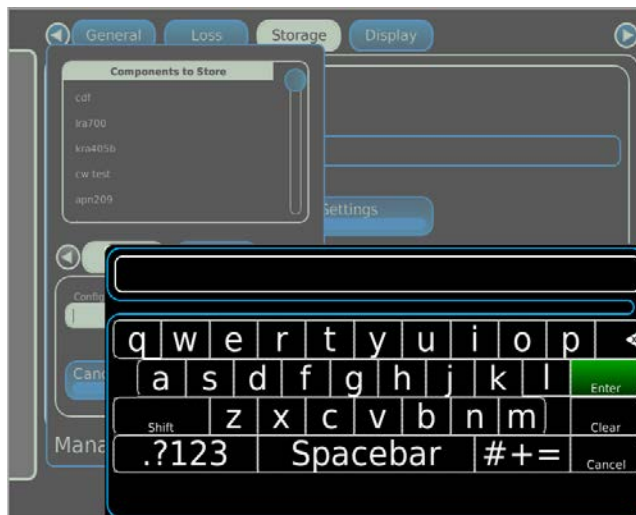

Fig. 3-14 Manage Settings Window (Store Name Entry)

Delete Settings

STEP	PROCEDURE
1.	Press Delete tab to access delete functions in Manage Settings Window.
2.	Select the stored file to be deleted from the Stored Settings Name list.
3.	Press the Delete Store key to delete stored file.



Fig. 3-15 Manage Settings Window (Delete Settings)

Recall Settings

STEP	PROCEDURE
1.	Select the Recall Settings key displays the stored settings. Settings files are stored in sequence of entry.
2.	Select a setting and press Recall.

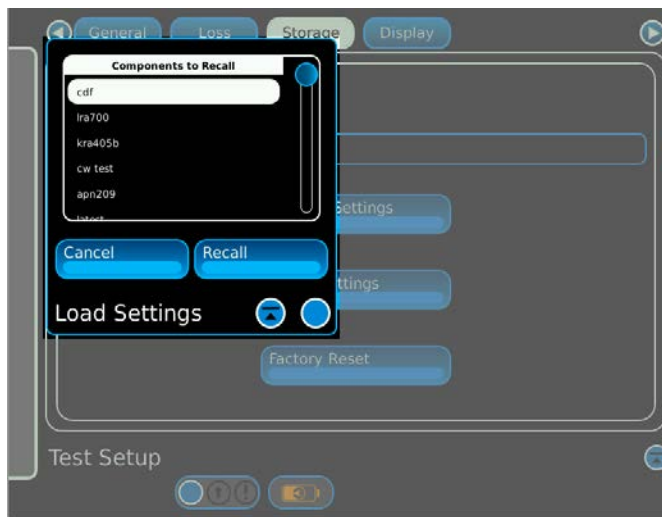

Fig. 3-16 Load Settings Window (Recall Settings)

Reset Settings

Selecting the Factory Reset key will reset the test settings to default.

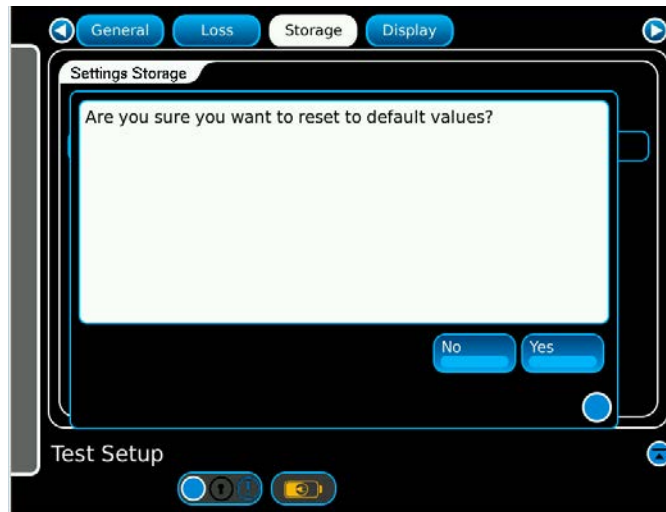

Fig. 3-17 Storage Tab Window (Factory Reset)

3.4.3 Display Tab

Display Tab allows changes to the frequency display mode, profile units and the power levels. These settings are not affected when loading stored settings. These settings are retained even when the test set is powered off. These settings are reset on a factory reset.

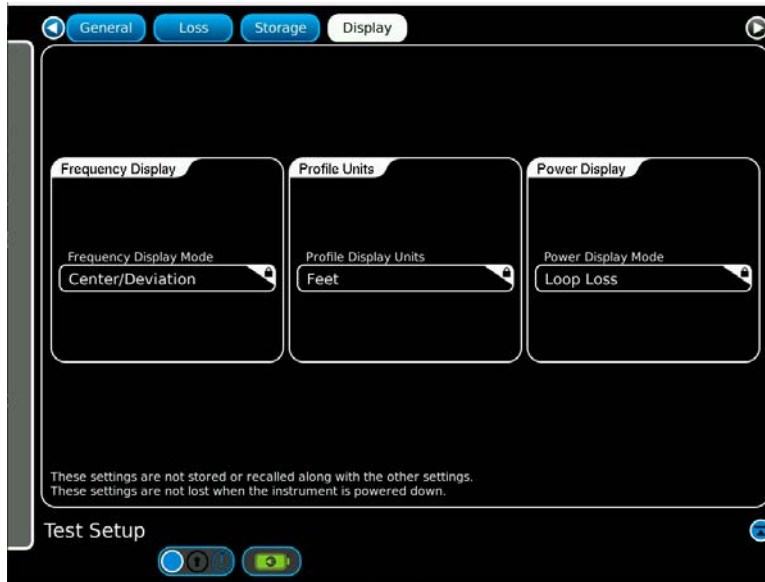

Fig. 3-18 Display Tab Window

Display Tab Control Component	Description
Frequency Display	Click in the Frequency Display Mode field to change the display modes on the Simulation Screen. Center/Deviation or Start/Stop may be selected.
Profile Units	Click in the Profile Display Units field to change the unit of measurements on the plot on the Profile Setup Screen. Feet and Meters may be selected.
Power Display	This field is set for Loop Loss. Locked.

3.5 SELF TEST

The Self Test Function Window confirms the Test Set is operating correctly.



Fig. 3-19 Self Test Screen

The one foot loopback cable must be attached between the test set’s UUT:TX and UUT:RX RF Connectors before running the Self Test.

The Self Test Function Window displays the Self Test data when the test is running.

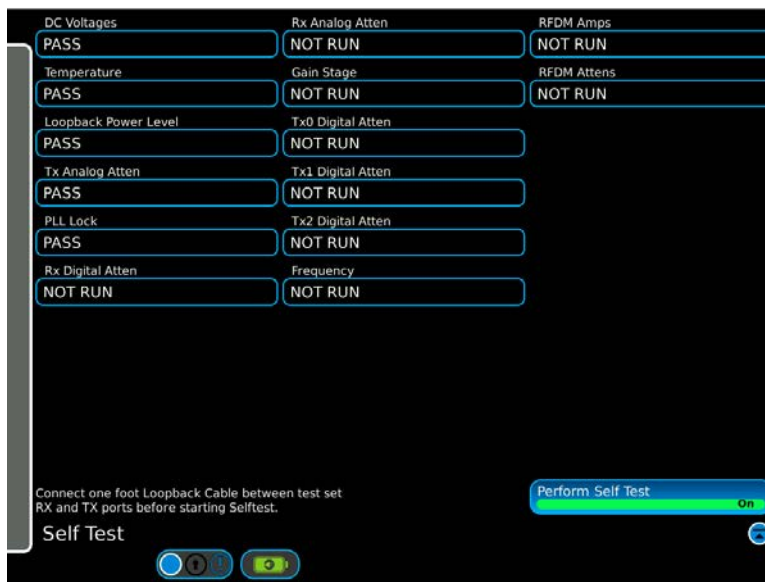

Fig. 3-20 Self Test Running

The Self Test Function Window displays the Self Test results when the Self Test has been completed.

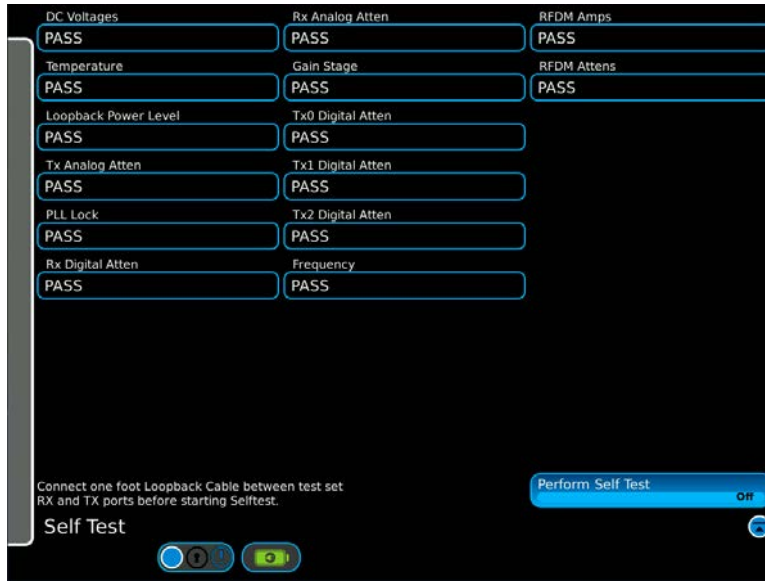

Fig. 3-21 Self Test Passed

3.5.1 Status Bar Alert Messages

The Status Bar is displayed at the bottom of each of the main function windows. The status bar displays and logs any system debug, status, warning, or error messages. These messages are generated by modules within the ALT-9000.



Fig. 3-22 Status Bar

3.5.1.A Alert Messages

The grey status bar may be pressed to display the Alert Message Log. The last 1,000 messages are displayed.

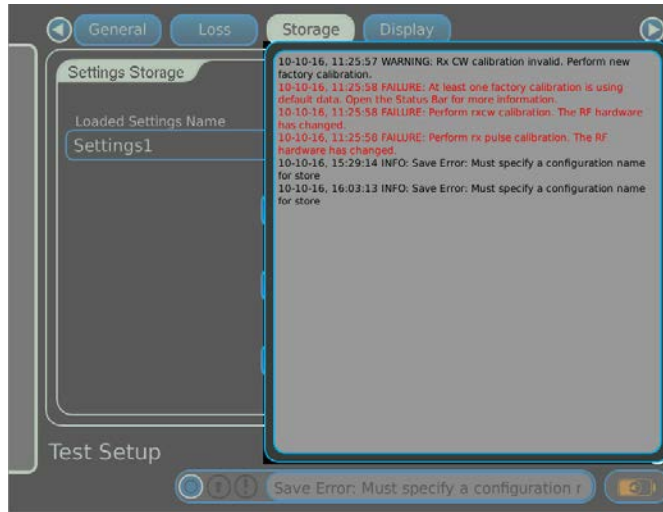

Fig. 3-23 Alert Message Log

Alert Messages displayed at power-up:

- TCXO calibration invalid. Perform new factory calibration.
- RX CW calibration invalid. Perform new factory calibration.
- RX pulse calibration invalid. Perform new factory calibration.
- Transmit calibration invalid. Perform new factory calibration.
- Loopback calibration invalid. Perform new factory calibration.
- User delay calibration invalid. Perform calibration before running tests.
- At least one factory calibration is using default data. Open the Status Bar for more information.

Alert messages displayed during factory calibrations:

- Loopback calibration failure: Power too low. Is the loopback cable connected?
- Loopback calibration failure: Unable to optimize signal level during analog attenuator offset calibration.
- Loopback calibration failure: Failed to detect pulses at receiver.
- Loopback calibration failure: Unable to measure consistent pulse width during pulse width during vref5 calibration.

Alert Messages displayed on completion of user calibration:

- Delay calibration failure: Failed to determine cable delay for pulse mode.
- Delay calibration failure: Failed to determine cable delay for FM CW mode.
- Delay calibration failure: No signal detected at RF In.
- Delay calibration failure: Too much loss. Remove any external attenuators. If there are no external attenuators attached, then use lower loss cables.
- Delay calibration completed successfully.

Alert Messages displayed when a test is started:

- UUT center frequency out of range. Test stopping.
- UUT transmit frequency too high. UUT measurements continue but no RF is output.
- Unable to detect reasonable UUT signal. Testing stopped.
- Signal at RF In appears to be CW.
- Power too low at RF In. Testing stopped.
- Pulse Power too low at RF In. Testing stopped.
- Invalid Pulse UUT Detected. Testing stopped.
- Power level varying, cannot determine level. Testing stopped.
- A level flight path has been entered with an Altitude Rate. Change the Altitude Rate to 0 for level flight. Testing stopped.
- User set Sweeping subtype does not match detected Search/Track subtype. Testing will continue but results are unpredictable.
- RF firmware requires an update to support Gated FMCW radio altimeters. Testing stopped.

Alert Messages displayed during store/recall:

- Manage Profile window open : please close window and try again.
- Load Profile window open : please close window and try again.
- Manage Settings window open : please close window and try again.
- Load Settings window open : please close window and try again.

Testing

4

4.1 INTRODUCTION

This chapter provides details of standard tests for Radio Altimeter receivers.

Antenna Coupler

Two couplers are supplied. One to be labeled TX by the customer using the supplied decal; install over the TX antenna, and another to be labeled RX by the customer using the supplied decal, which is installed over the RX antenna. The active element in these couplers are encased in radar-absorbent foam. A 1-inch deep RF edge-mounted gasket provides an RF non-scratching seal to the fuselage.



Fig. 4-1 ALT-9000 Antenna Coupler

Adjustable Gas-Loaded Shock Unit

The 10.5 inch to 16 inch Gas-Loaded Shock Unit is adjustable and applies a pre-loaded upward pressure to hold the antenna couplers in place and allows for aircraft fuselage movement.



Fig. 4-2 Pole #1

Sectional Extension Poles

Sectional Extension Poles allow height extension up to a maximum of 91 inches (ground to coupler gasket). A 9 inch pole, a 15-24 inch adjustable pole and two 24 inch poles are included.



Fig. 4-3 Extension Pole #2



Fig. 4-4 Extension Pole #3

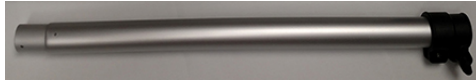

Fig. 4-5 Extension Pole #4

Low Loss RF Coax Cable, 20 ft

The 20 ft Coax Cable connects the Test Set to the UUT or Antenna Coupler, depending on the test mode.



Fig. 4-6 Low Loss RF Coax Cable, 20 ft

Low Loss Coax Cable, 4 ft

The 4 ft Coax Cables are used to reach a lower simulated altitude which is not obtainable using the 20 ft coax cables.



Fig. 4-7 Low Loss Coax Cable, 4 ft

Jumper RF Coax Cable, 1 ft

The 1 ft Jumper RF Coax Cable is used during Self Test and factory calibration.



Fig. 4-8 Jumper RF Coax Cable

Attenuators

20dB RF Attenuators are installed on the UUT:RX connector when a lower loop loss level is desired.



Fig. 4-9 Attenuator, fixed 20 dB

4.2 CONNECTION

4.2.1 Direct Connection

Perform the following steps to direct connect to the altimeter:



Note:

If testing Low Power Pulse-type Radio, see [Section: 4.2.4](#).

STEP	PROCEDURE
1.	Place the ALT-9000 within cable length of the aircraft Radio Altimeter.
2.	Connect the Low Loss RF Coax Cables to the ALT-9000 UUT:TX/UUT:RX TNC connectors.
3.	Perform Setup procedure (4.3).
4.	Remove the Radio Altimeter TX and RX cables from the altimeter.



Caution:

DO NOT CONNECT ALT-9000 UUT:RX PORT TO RADIO ALTIMETER TX PORT. DAMAGE WILL RESULT TO THE ALT-9000 UUT:RX PORT. MAXIMUM REVERSE POWER: 100mW.

5. Refer to [Fig. 4-10](#). Connect the UUT:TX RF coax cable to the altimeter.

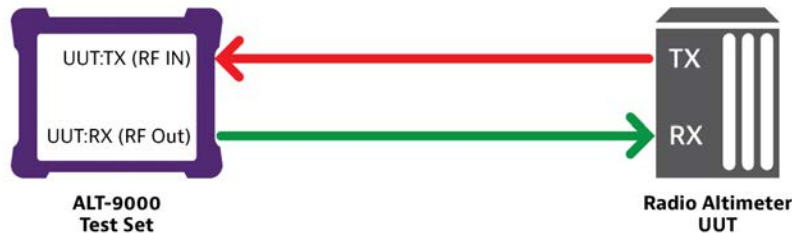

Fig. 4-10 Direct Connection

STEP	PROCEDURE
6.	If there is doubt about which Radio Altimeter Port is the TX Port, select Launch Bar tab to display launch bar. Select Simulation function key to display Simulation Window. Press Run to start test and confirm that a TX Power reading is displayed.



Note:

The ALT-9000 will not function correctly if cable connections are reversed.

4.2.2 Antenna Coupler Installation and Connection

Perform the following steps to install the Antenna Coupler:



Note:

If testing Low Power Pulse-type Radio, see [Section: 4.2.4](#).

STEP	PROCEDURE
------	-----------

1. Place the ALT-9000 within cable length of the aircraft under test radio altimeter antennas.
2. Connect the 20 ft Low Loss RF Coax Cables to the ALT-9000 UUT:TX/UUT:RX TNC connectors.
3. Perform Setup procedure (4.3).
4. Select the correct sectional pole lengths that allow support of the Antenna Couplers over the aircraft radio altimeter antennas. Assemble pole sections.
5. Mount the Antenna Couplers to the end of each completed sectional pole.



Note:

Note: The coupler has a decal with an arrow on it. When properly installed, the arrow on the coupler should be pointing FORWARD (toward the nose of the A/C).

6. Press down on each pole assembly until the Gas Shock compresses and lock the retaining clamp. The amount of compression should allow the pole to be raised into place with a 2-3: gap between the antenna coupler and the Radio Altimeter Antenna.
7. Refer to [Fig. 4-11](#). Connect the Antenna Coupler's TNC connectors to the RF Coax Cables as indicated.

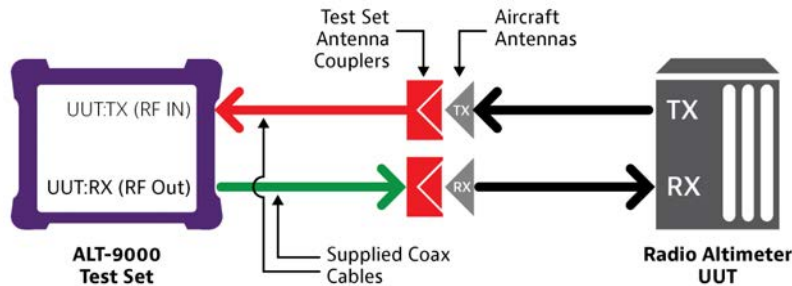

Fig. 4-11 ALT-9000 RF Connections

STEP	PROCEDURE
------	-----------

8. Raise the TX pole assembly and place the (UUT:TX) Antenna Coupler directly under the TX Radio Altimeter Antenna. When the pole is vertical, release the Gas Shock retaining clamp to apply the preloaded upward pressure on the Antenna Coupler.



Note:

Do not re-tighten the retaining clamp on the gas shock.

STEP

PROCEDURE

9. If there is doubt about which Radio Altimeter Antenna is the TX antenna, select Launch Bar tab to display launch bar. Select Simulation function key to display Simulation Window. Press Run to start test and confirm that a TX Power reading is displayed. If a TX power reading is displayed then the UUT TX antenna coupler is placed over the TX antenna.



Note:

In multiple system installations, the TX/RX antennas for a specific system are aligned in a forward-aft direction. The ALT-9000 will not function correctly if the antenna couplers are placed over the wrong aircraft antennas.

10. Raise the RX pole assembly and place the (UUT:RX) Antenna Coupler over the RX Radio Altimeter Antenna. When the pole is vertical, release the Gas Shock retaining clamp to apply the preloaded upward pressure on the Antenna Coupler.



Caution:

DO NOT CONNECT ALT-9000 UUT:RX PORT TO RADIO ALTIMETER TX PORT. DAMAGE WILL RESULT TO THE ALT-9000 UUT:RX PORT. MAXIMUM REVERSE POWER: 100mW.

4.2.3 Feeder Connection

Perform the following steps to install the Antenna Feeders:

STEP	PROCEDURE
1.	Place the ALT-9000 within cable length of the aircraft under test Radio Altimeter Antennas.
2.	Connect the Low Loss RF Coax Cables to the ALT-9000 UUT:TX/UUT:RX TNC connectors.
3.	Perform setup procedure (4.3).
4.	Remove the Radio Altimeter TX and RX antennas.
5.	Refer to Fig. 4-12. Connect the UUT:TX RF coax cable to the TX Feeder.

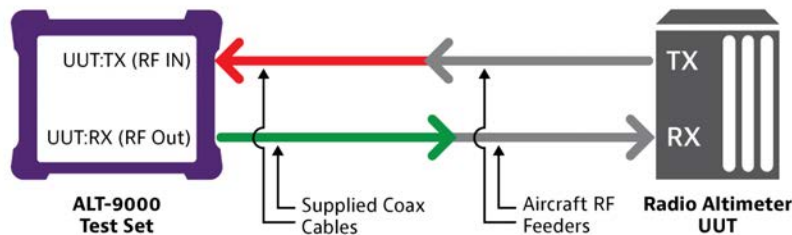

Fig. 4-12 ALT-9000 RF Connections (Feeders)

- If there is doubt about which Radio Altimeter Feeder cable is the TX Feeder, select Launch Bar tab to display launch bar. Select Simulation function key to display Simulation Window. Press Run to start test and confirm that a TX Power reading is displayed.
- Connect the UUT:RX RF coax cable to the RX Feeder.



Caution:

DO NOT CONNECT ALT-9000 UUT:RX PORT TO RADIO ALTIMETER TX PORT. DAMAGE WILL RESULT TO THE ALT-9000 UUT:RX PORT. MAXIMUM REVERSE POWER: 100mW.

4.2.4 Coupler Connection with External Attenuators

This coupler setup is for testing altimeters where the use of an external attenuator is required.

STEP	PROCEDURE
1.	Place the ALT-9000 within cable length of the aircraft under test Radio Altimeter Antennas.
2.	Connect the 20ft Low Loss RF Coax Cables to the ALT-9000 UUT:TX/UUT:RX TNC connectors.
3.	Perform Setup procedure; refer to Section: 4.3 .
4.	Insert the a 20dB attenuators between the UUT:RX port and the UUT:RX Coax cable.
5.	Input the ext attenuator loss value.
6.	Select the correct sectional pole lengths that allow support of the Antenna Couplers over the aircraft radio altimeter antennas. Assemble pole sections.
7.	Mount the Antenna Couplers to the end of each completed sectional pole.



Note:

Note: The coupler has a decal with an arrow on it. When properly installed, the arrow on the coupler should be pointing FORWARD (toward the nose of the A/C).

- Press down on each pole assembly until the Gas Shock compresses and locks the retaining clamp. The amount of compression should allow the pole to be raised into place.
- Refer to [Fig. 4-13](#). Connect the Antenna Coupler's TNC connectors to the RF Coax Cables as indicated.

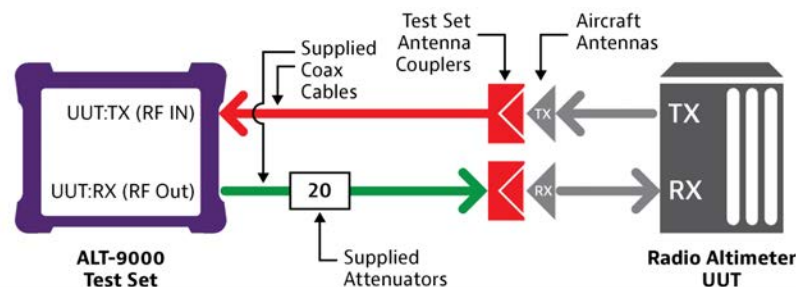

Fig. 4-13 ALT-9000 Coupler Connection

- Raise the TX pole assembly and place the (UUT:TX) Antenna Coupler over the TX Radio Altimeter Antenna. When the pole is vertical, release the Gas Shock retaining clamp to apply the preloaded upward pressure on the Antenna Coupler.

STEP

PROCEDURE

11. If there is doubt about which Radio Altimeter Antenna is the TX antenna, select Launch Bar tab to display launch bar. Select Simulation function key to display Simulation Window. Press Run to start test and confirm that a TX Power reading is displayed.



Note:

The ALT-9000 will not function correctly if the antenna couplers are placed over the wrong aircraft antennas.

12. Raise the RX pole assembly and place the (UUT:RX) Antenna Coupler over the RX Radio Altimeter Antenna. When the pole is vertical, release the Gas Shock retaining clamp to apply the preloaded upward pressure on the Antenna Coupler.



Fig. 4-14 ALT-9000 Antenna Coupler Installed

4.3 SETUP

Perform the following steps for setup:

STEP	PROCEDURE
1.	Press Power button for a minimum of 1 second to power up test set.
2.	Select Test Setup function key to display Test Setup Window.
3.	Confirm the following settings and change as necessary. <ul style="list-style-type: none"> • Attenuation Loss Values, as applicable. <p>RF Port</p> <ul style="list-style-type: none"> • Connection Type = Coupler (if using antenna couplers) or Direct (connection is directly to LRU, or at the feeder connection). • UUT:TX Coupler Loss = Figure in dB marked on TX Antenna Coupler (for Coupler mode only). • UUT:RX Coupler Loss = Figure in dB marked on RX Antenna Coupler (for Coupler mode only). <p>RF Settings</p> <ul style="list-style-type: none"> • Level Mode = Auto • UUT:TX Cable Loss = Figure in dB marked on TX cable. • UUT:RX Cable Loss = Figure in dB marked on RX cable.



Caution:

UUT:TX PORT MAXIMUM POWER: 300 W, 5 W AVERAGE.

4. Select **Delay Calibration** to display the Delay Calibration screen (Fig. 4-15). This screen starts the calibration procedure for Test Set/RF coaxial cable delay.

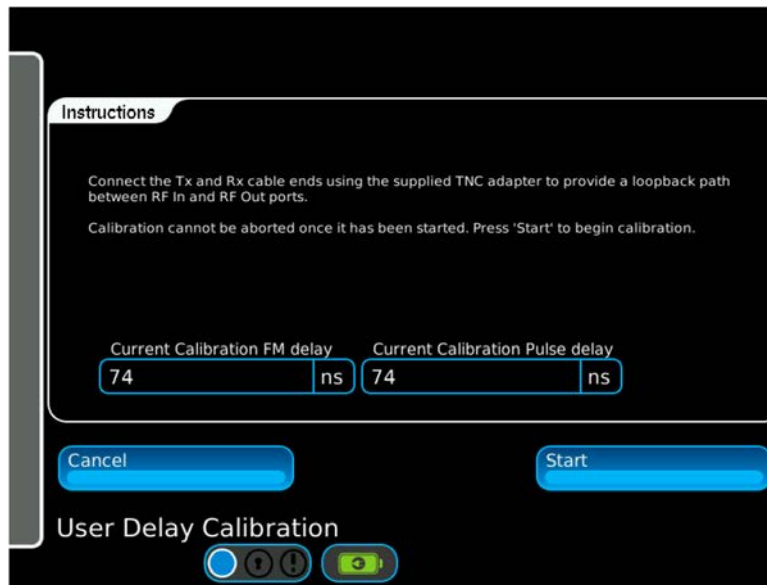



Fig. 4-15 Delay Calibration Screen

STEP	PROCEDURE
5.	Connect the ends of the TX and RX cables together using the supplied TNC Connector.
6.	Select Start to start delay calibration. The calibration process is automatic. When delay calibration is complete the Test Setup screen is displayed.
	Note: Delay calibration may not be aborted once started.
7.	Disconnect the TNC Connector from the TX and RX cables.

4.4 TESTS

4.4.1 Linear Altitude Ramp Test

The Linear Altitude Ramp Test will perform a linear up and down altitude ramp, verifying adequate UUT loop gain. This is the lowest level of flight-line testing recommended to confirm reported problems, or to verify system operation after LRU replacement.

Perform the following steps to execute the Linear Altitude Ramp Test:

STEP	PROCEDURE
------	-----------

1. Confirm the following settings and change as necessary:

Control

- Start Altitude = 0 ft
- Stop Altitude = 2,500 ft
- Altitude Rate = 500 ft/min (5 min duration)



Note:

Decision Height (DH) trips should be verified on a descending ramp, with a descent rate of 100 ft/min or less, to allow verification of DH indicator and any audible warning.

2. Select **Run** key to start simulation. Altitude Pause is displayed.

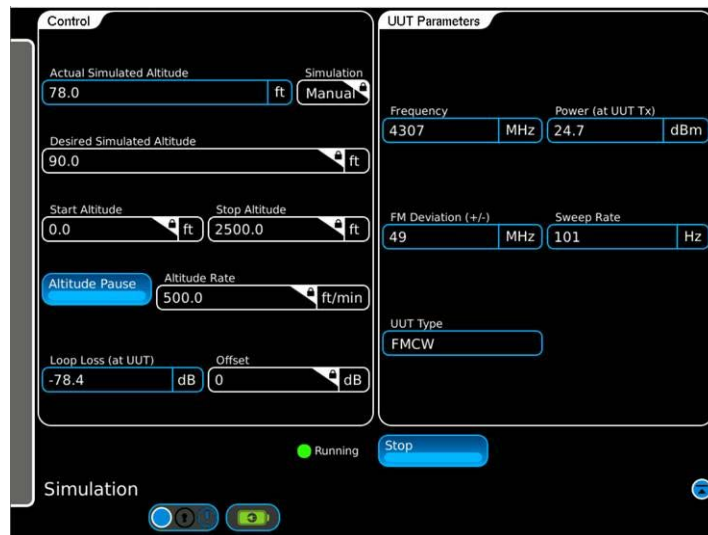

Fig. 4-16 Altitude Pause Key

STEP

PROCEDURE

3. Confirm Aircraft altitude indicator tracks altitude smoothly from 0 to 2,500 ft and there is no indicator flag in view.



Note:

Sudden indicator display of a ground height (-10 ft) is indicative of an aircraft antenna ground plane bonding problem or RF feeder cable termination problem, resulting in leakage between TX and RX antennas. This will usually manifest at higher altitude when the reflected TX power seen by the receiver falls below the level of leakage.

Control

- Actual Simulated Altitude = displays current test set simulated altitude

4. To pause simulation at any point select **Altitude Pause** key.

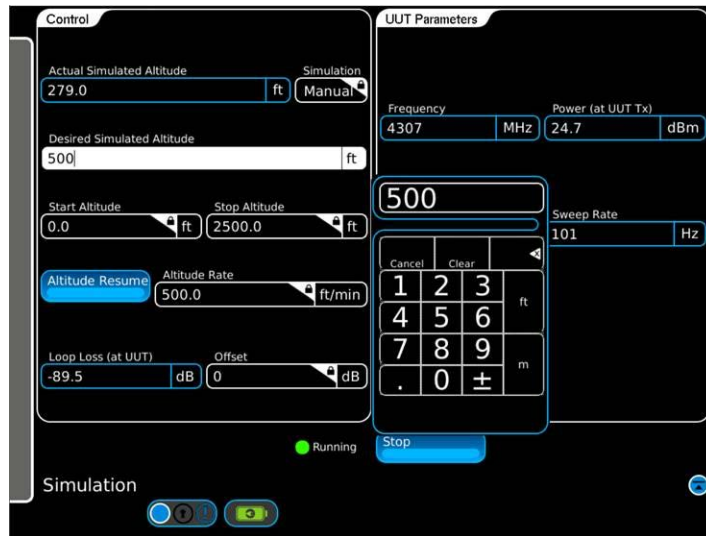

Fig. 4-17 Paused Altitude Rate

5. Select **Altitude Resume** key to resume simulation from Actual Simulated Altitude.



Note:

- EFIS displays typically apply variable altitude resolution (i.e., 0 to 100 ft = 2 ft resolution, 100 to 500 ft = 10 ft resolution, > 500 ft = 20 ft resolution).
- Some instrument systems will not display altitude ramps starting at altitude descending to zero feet. Use the profile feature to create a suitable test ramp for these systems. Example: 0 to 2,500 ft at 500 ft/min followed by 2,500 to 0 ft at 100 ft/min. The slower descent rate allows the DH trip to be verified.

4.4.2 Profile Creation

The Profile Altitude Test will execute a sequence of linear altitude ramp legs. Together the legs form a profile, which can simulate a complete approach/landing or departure simulation. Profiles are used to test radio altimeters coupled with auto-land systems.

Perform the following steps to setup an example four leg descent profile:

STEP	PROCEDURE
1.	Press Power button for a minimum of 1 second to power up test set.
2.	Select Launch Bar tab to display launch bar. Select Profile Setup function key to display Profile Setup Window.
3.	Select Add key to display Add Leg window.
4.	Leg # 1:
a.	Select Start Altitude to display numeric pad and enter Start Altitude = 1510 ft, select Enter to confirm parameter.
b.	Select Stop Altitude to display numeric pad and enter Stop Altitude = 1500 ft, select Enter to confirm parameter.
c.	Select Altitude Rate to display numeric pad and enter Altitude Rate= 60 fpm,select Enter to confirm parameter.
d.	Select Enter to confirm leg. Leg #1 will now be displayed in the Simulation Legs table.
5.	Select Add Leg key to display Add Leg window
6.	Leg # 2:
a.	Select Start Altitude to display numeric pad and enter Start Altitude = 1500 ft, select Enter to confirm parameter.
b.	Select Stop Altitude to display numeric pad and enter Stop Altitude = 1,000 ft, select Enter to confirm parameter.
c.	Select Altitude Rate to display numeric pad and enter Altitude Rate= 1500 fpm, select Enter to confirm parameter.
d.	Select Enter to confirm leg. Leg #2 will now be displayed in the Simulation Legs table.
5.	Select Add Leg key to display Add Leg window.

STEP

PROCEDURE

6. Leg # 3:

- a. Select **Start Altitude** to display numeric pad and enter Start Altitude = 1,000 ft, select **Enter** to confirm parameter.
- b. Select **Stop Altitude** to display numeric pad and enter Stop Altitude = 10 ft, select **Enter** to confirm parameter.
- c. Select **Altitude Rate** to display numeric pad and enter Altitude Rate= 2970 fpm, select **Enter** to confirm parameter.
- d. Select **Enter** to confirm leg. Leg #3 will now be displayed in the Simulation Legs table.

5. Select **Add** key to display Add Leg window.

6. Leg # 4:

- a. Select **Start Altitude** to display numeric pad and enter Start Altitude = 10 ft, select **Enter** to confirm parameter.
- b. Select **Stop Altitude** to display numeric pad and enter Stop Altitude = -5 ft, select **Enter** to confirm parameter. **NOTE:** In a de-rotated configuration, radio altimeter will display a negative altitude.

**Note:**

In a de-rotated configuration, radio altimeter will display a negative altitude.

- c. Select **Altitude Rate** to display numeric pad and enter Altitude Rate = 90 fpm, select **Enter** to confirm parameter.
- d. Select **Enter** to confirm leg. Leg #4 will now be displayed in the Simulation Legs table.

5. To store the profile, select **Store Current Profile** key to open alpha numeric pad and enter profile name (e.g., "Approach") . Name may be up to 20 characters long. Select **Enter** when complete. The new profile name will now appear in profile list in Manage Profiles and also displayed in the Profile Name field.

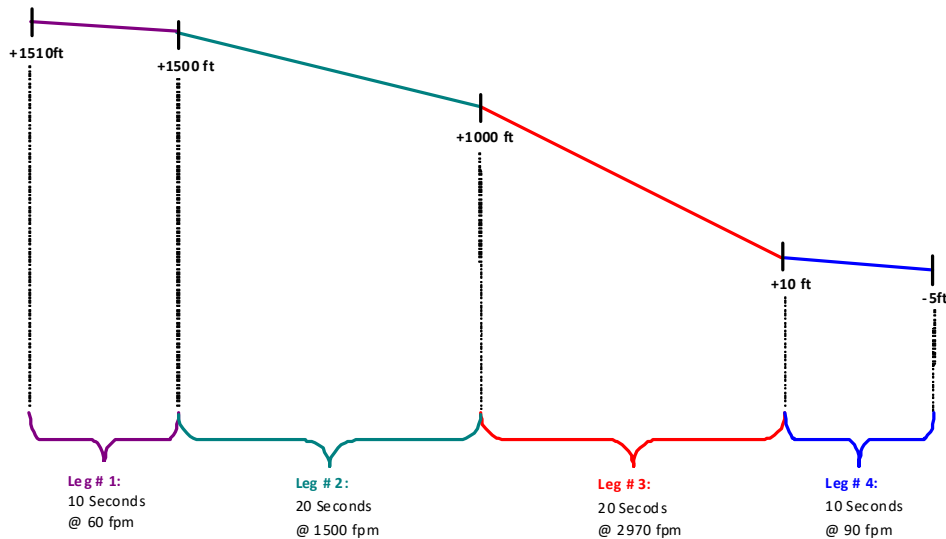

Fig. 4-18 Multi-leg Profile Example

4.4.3 Profile Altitude Test

Perform the following steps to setup a Profile Altitude Test:

STEP	PROCEDURE
1.	Perform the Setup procedure (4.3).
2.	Select Launch Bar tab to display launch bar. Select Profile Setup function key to display Profile Setup window.
3.	Select Recall Profile key to display Load Profile window. Select desired profile listed in profile table and select Recall . Recalled profile will now be resident in memory and ready for execution.
4.	Select Launch Bar tab to display launch bar. Select Simulation function key to display Radio Altimeter Function Test Window.
5.	Confirm the following setting and change as necessary: <ul style="list-style-type: none"> • Control Simulation = Profile
6.	Select Run key to start simulation.
7.	The Start Altitude, Stop Altitude and Altitude Rate will be displayed for the current leg. Current Simulated Altitude is also displayed.
8.	To view the overall progress of the profile execution, the Profile Setup function window displays a graphical plot of the simulated altitude versus time.

4.4.4 UUT Parametric Tests

Although the Auto RF Level mode ensures that loop gain is verified and system integrity is verified, there are times when it is desirable to review the parametric performance of an LRU, particularly when intermittent problems have been reported.

**Note:**

Manufacturers specifications should always be referred to.

LRU Review Guidelines

Frequency: Varies between LRRRA models. Typically centered at 4.3 GHz \pm 70 MHz.

FM Deviation: Varies between LRRRA models. FMCW types typically 100 to 140 MHz.

Sweep Rate: Varies between LRRRA models. FMCW types typically 50 to 160 Hz.

**Note:**

In a dual or triple LRRRA installation, each LRU may have a different sweep rate set, to avoid cross channel interference.

Power: Varies between LRRRA models. FMCW types typically 150 mW to 1 W.

**Note:**

- Manufacturers power specifications are stated at the LRU, so expect lower power levels to be measured at the Aircraft Antenna.
- Typical Aircraft Antenna gains are 10 dBi (radiated). Because the ALT-9000 antenna couplers couple in the near field of the antenna, this gain will not be realized.

In cases where a Linear Altitude Ramp Test has been performed, with RF Level set to Auto and a tracking failure occurs (i.e., indicator flag in view) a power measurement can be made to determine if the problem is in the TX path and where in the TX path.

Possible TX Path Problems

- LRU TX Power low
- RF Feeder cable
 - a. Excessive loss or bad VSWR due to coax cable water ingress.
 - b. Bad connector Termination
- TX Antenna Bad
 - a. Mechanical damage
 - b. Lightning strike
 - c. Corrosion due to water ingress

If a power test at the aircraft antenna is satisfactory, the RX path should be investigated.

Possible RX Path Problems

- LRU RX sensitivity low
- RF Feeder cable Bad
 - a. Excessive loss or bad VSWR due to coax cable water ingress.
 - b. Bad connector Termination
- RX Antenna Bad
 - a. Mechanical damage
 - b. Lightning strike
 - c. Corrosion due to water ingress

Removal of both TX and RX aircraft antennas and connection of the ALT-9000 via feeder, will determine if the antennas were faulty or if the problem still persists.

If the aircraft antennas are removed, the RF feeder cables should be checked for connector termination soundness and any signs of water ingress, which typically discolors the feeder cable sheath. Antennas should be inspected for corrosion that may effect ground plane bonding.

Parametric Test Procedure

STEP	PROCEDURE
1.	Perform setup procedure (4.3). Confirm the following Control settings and change as necessary: <ul style="list-style-type: none"> • Start Altitude = 1000 ft • Altitude Rate = 0 ft/min (2.5 mins duration) Note: Entering a rate of 'zero' disables the Stop Altitude field.
2.	Select Run key to start simulation.
3.	The UUT Parameters section displays the measurements (Fig. 4-19).

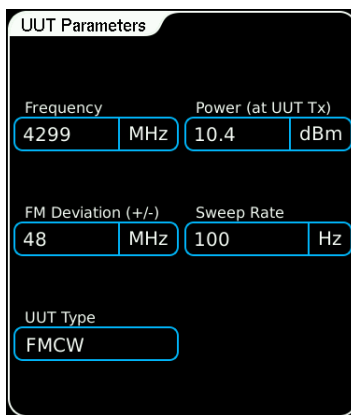



Fig. 4-19 UUT Parameters
(part of the Simulation Function Window)

Receiver Sensitivity Test Procedure

STEP	PROCEDURE
1.	Perform setup procedure (4.3).
2.	Select Launch Bar tab to display launch bar. Select Test Setup function key to display Test Setup Window. <ul style="list-style-type: none">• RF Settings Level Mode = Manual
3.	Select Launch Bar tab to display launch bar. Simulation function key to display Radio Altimeter Function Test Window.
4.	Confirm the following setting and change as necessary: <ul style="list-style-type: none">• Start Altitude = 2,500 ft• Altitude Rate = 0 ft/min
5.	Select Run key to start simulation.
	 Note: LRRR LRUs typically reduce their receiver sensitivity as altitude decreases to avoid false locks. Testing at typically 2,500 ft altitude should ensure that maximum receiver sensitivity is measured.
6.	Adjust Loop Loss until the RadAlt loses lock: <ul style="list-style-type: none">a. Adjust the loop loss level.b. Increase until the RadAlt just regains lock.

4.5 IDENTIFYING INSTALLED SOFTWARE VERSION

Perform the following steps to identify the software version installed in the ALT-9000.

STEP	PROCEDURE
1.	Press the Power button to turn the test set on.
2.	Allow the test set to complete the boot process, approximately 3 to 5 mins.
3.	Open the Launch Bar, if necessary, by touching the light gray bar located on the left side of the user interface and scroll down to the System function key if it is not displayed.
4.	Touch the System function key to open the System pull down menu and select System Update.
5.	In the Version window the unit serial number and currently installed software version number is displayed.

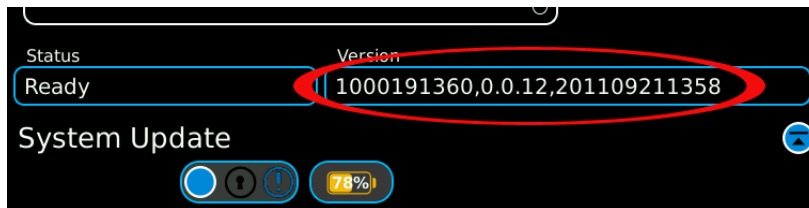

In this example, the serial number is 1000191360, the software version is 0.0.12 and the software was released on 2011/09/21 at 1358.

4.5.1 Options Function Window

The ALT-9000 software requires an options file for operation. This file is loaded at the factory and can be seen under the Options page. Selecting Options from the System sub-menu will display the Options Function Window.

The Options Function Window provides control for installing or removing options and displays currently installed options.



Fig. 4-20 Options Function Window

Control Component	Description
Copy from USB	Initiates Copy of Option License files from a USB memory device installed in USB Port.
Copy from Server	Initiates Copy of Option License files from a server. <ul style="list-style-type: none"> • NOTE: Factory use only.
Install License	Installs Option License files that have been copied to the internal memory.
Remove License	Removes Option License files. <ul style="list-style-type: none"> • NOTE: This will permanently remove installed options.

Display Component	Description
Status	Displays status messages to inform the user of progress or errors.
Serial Number	Displays the serial number of the ALT-9000.
Unique ID	Displays the Unique ID of the ALT-9000.
Option	Displays installed options.
User	Displays User log-in ID. <ul style="list-style-type: none"> • NOTE: Default is ALL if no user login required.
Installed	Displays date option was installed.
Expires	Displays date option expires. <ul style="list-style-type: none"> • NOTE: If no expiration date displays -1.
Server IP	Numeric Pad: Enter the Server IP address.

Maintenance

5

5.1 GENERAL

This chapter contains Operator-level maintenance procedures.

Table 5-1 Procedure Level

COMPONENT	LEVEL
Visual Inspection	Operator
External Cleaning	Operator
Primary Battery (BT2)	Operator
Backup Battery (BT1)	Operator

5.1.1 Tools Requirements

Some maintenance procedures may require tools.

Table 5-2 Remove/Install Tool Requirements

TOOL	SIZE
Electronics Screwdriver	Hex-tip 2 mm, 2.5 mm, 3 mm
Electronics Screwdriver	Cross-recessed 6" & 10"
Standard #2 Screwdriver	Straight Blade

5.2 INSPECTIONS

5.2.1 Visual Inspections

Visual inspections should be performed periodically depending on operating environment, maintenance and use.

5.3 CLEANING

5.3.1 External Cleaning

STEP	PROCEDURE
1.	Clean front panel buttons and display face with soft lint-free cloth. If dirt is difficult to remove, dampen cloth with water and a mild liquid detergent.
2.	Remove grease, fungus and ground-in dirt from surfaces with soft lint-free cloth dampened (not soaked) with isopropyl alcohol.
3.	Remove dust and dirt from connectors with soft-bristled brush.
4.	Cover connectors, not in use, with suitable dust cover to prevent tarnishing of connector contacts.
5.	Clean cables with soft lint-free cloth.
6.	Paint exposed metal surface to avoid corrosion.

5.4 COMPONENT MAINTENANCE

5.4.1 Battery Replacement

The ALT-9000 has 2 batteries: BT1 and BT2.

- BT1 is the Backup Battery. The Backup Battery is a small, 'coin' battery.
- BT2 is the Primary Battery. The Primary Battery (BT2) is a rechargeable Lithium Ion Battery (LIB) Pack.

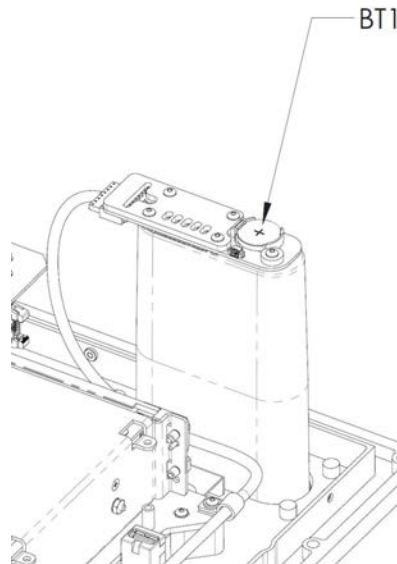

Fig. 5-1 Locator View, Coin Battery

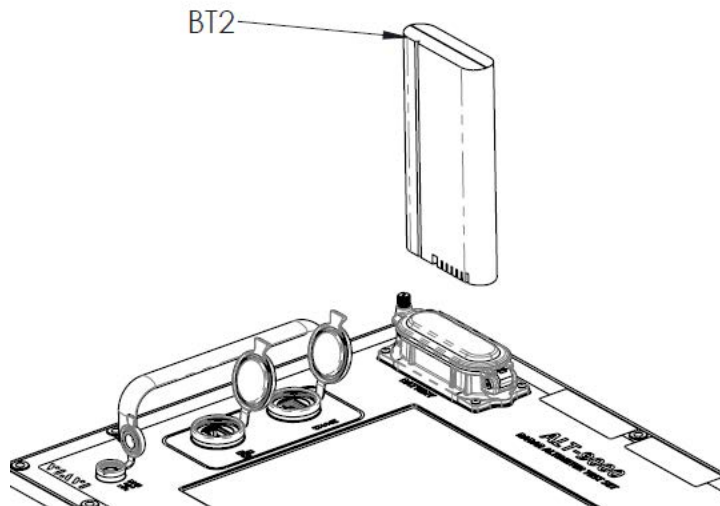

Fig. 5-2 Locator View, Primary Battery

Remove Primary Battery

- Condition: Test Set is OFF
- Condition: Test Set is ESD GROUNDED on Benchtop

STEP	PROCEDURE
------	-----------

Note:

The Battery Port cover screw is a captured screw.

1. Using a #2 straight-bladed screwdriver, 'remove' the Battery Port cover screw from the battery housing.
2. Flip the Battery Port cover OPEN, providing access to the battery pack.

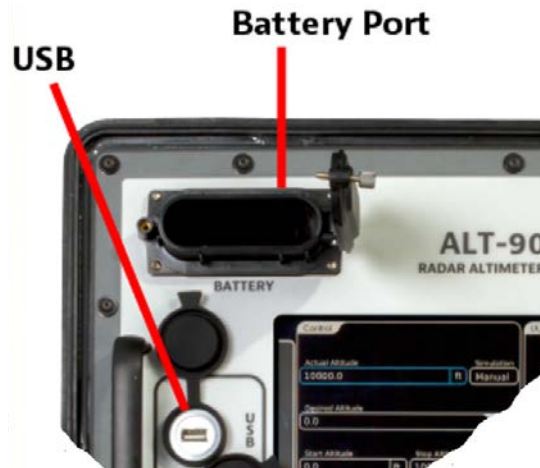

Fig. 5-3 Primary Battery Port (cover shown OPEN)

3. Extract the battery pack (BT2) from the battery housing.
4. Flip the Battery Port cover CLOSED to keep the battery well (inside the battery housing) free of foreign objects & debris (FOD).

Install Primary Battery

- Condition: Test Set is OFF
- Condition: Test Set is ESD GROUNDED on Benchtop
- Condition: Battery Port Cover is OPEN.

STEP	PROCEDURE
------	-----------

1. Inspect the battery well (inside the battery housing); ensure Battery Port is free of FOD.
2. Ensure proper orientation of the battery pack to the battery housing and insert the battery pack into the battery housing.
3. Flip the Battery Port cap to the CLOSED position.
4. Using a #2 straight-bladed screwdriver, 'secure' the Battery Port cover to the battery housing; tighten the screw.

Replace Backup Battery

- Condition: Test Set is OFF
- Condition: Test Set is ESD GROUNDED on Benchtop
- Condition: Primary Battery is REMOVED

STEP	PROCEDURE
------	-----------

- | | |
|----|---|
| 1. | Remove the Primary Battery. |
| 2. | Access the Backup Battery (BT1) as follows: <ol style="list-style-type: none"> Using a hex-tipped screwdriver, remove 4 battery housing screws from the front panel. See Fig. 5-4. |

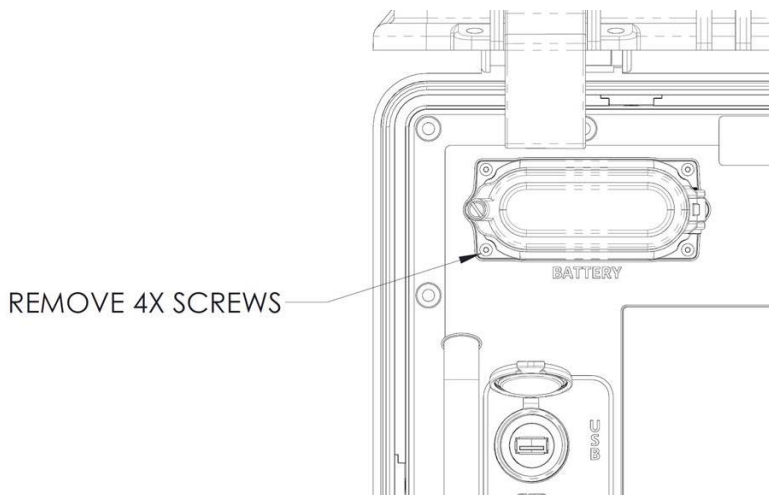

Fig. 5-4 Battery Housing Screws



Caution:

There are two cables attached to the battery housing. Do not tug the cables.

- Extract the battery housing from the front panel.
- Position the battery housing on the Front Panel as shown in [Fig. 5-5](#).

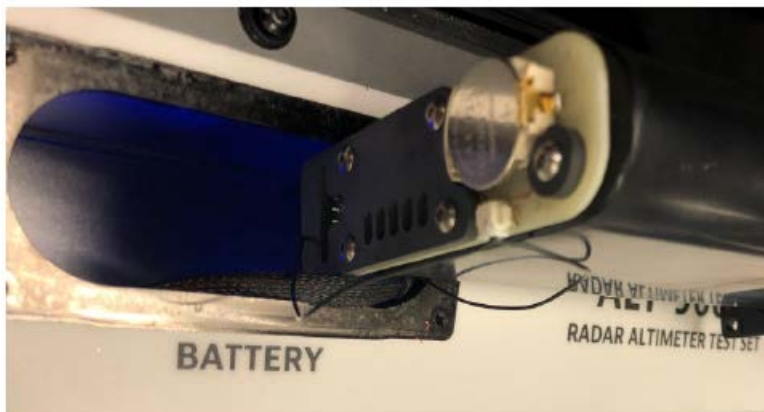

Fig. 5-5 Backup Battery Access

3. Remove the old backup battery.



WARNING:

DISPOSE OF OLD BATTERY ACCORDING TO LOCAL STANDARD SAFETY PROCEDURES.

4. Orient and Install the new battery.
5. Orient the battery housing. Taking care to repack the cables into the cavity, slide the battery housing into the front panel.
6. Using a hex-tipped screwdriver, install the battery housing on the front panel with 4 screws.

5.5 SOFTWARE MAINTENANCE

ALT-9000 Software Update

- Condition: Test Set is OFF.

STEP	PROCEDURE
1.	Prepare the USB memory device*: <ol style="list-style-type: none">Using a PC, obtain the latest software update zip file from VIAVI.Insert USB device into the PC and copy the zip file to the root directory of the USB memory device.Unzip the file onto the root directory of the USB device.Check files on the USB. Note: Uncompressed .rpm files (hidden) need to be in Instrument/Common.Safely remove the USB device from the PC.
2.	Insert the USB device in USB Port and Power ON the ALT-9000.

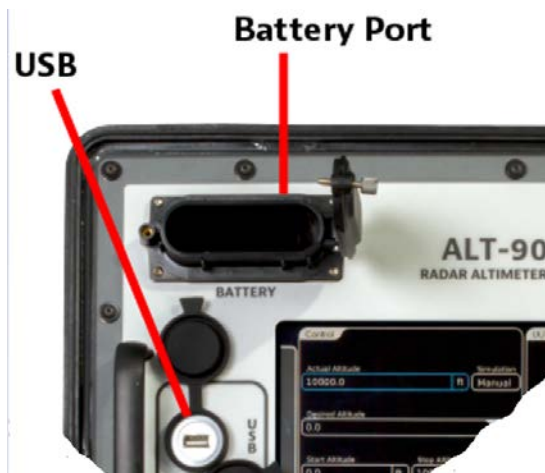

Fig. 5-6 USB Port

3. When prompted, remove the USB device from the instrument.
4. Reboot the instrument:
 - a. Invoke Shut DOWN (Press and hold the Power Button for 5 seconds).
 - Instrument performs shutdown.
 - b. Press the Power Button to invoke Power UP.
 - Instrument loads .rpm files / Instrument is Updated.

* Recommended USB memory Device: VIAVI PN 67327.

** If you experience a USB Error when trying to copy from USB, the USB device being used may not be compatible with the ALT-9000.

5.5.1 System Config Function Window

The System Config Function window is accessible via the Launch Bar System function key, as a sub selection. System Config displays five selectable tabs across the top of the screen. Status, Hardware, UI Options, Network and Date/Time.

5.5.1.A Status

The Status tab displays memory status, operating time, hardware module temperatures and provide internal SD card formatting control.

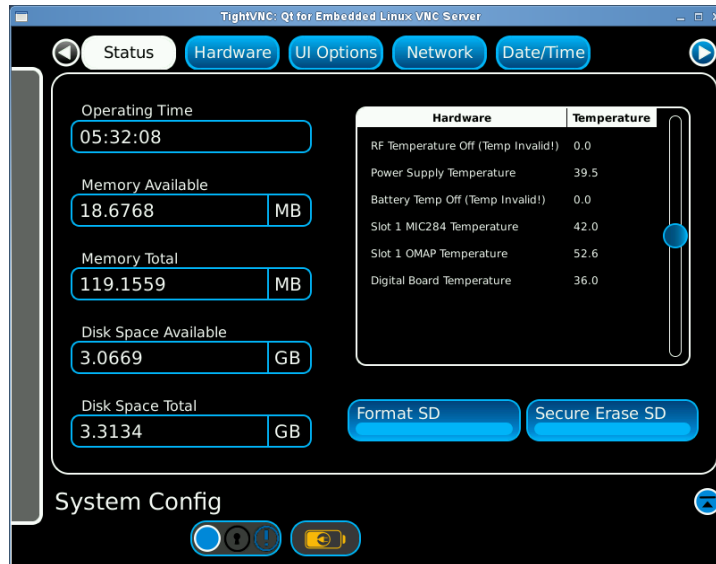

Fig. 5-7 System Config - Status

Display Component	Description
Operating Time	Displays the total operating time in hrs:mins:secs since power up.
Memory Available	Displays memory available to software resources in MB.
Memory Total	Displays total test set memory in MB.
Disk Space Available	Displays remaining disk space available in GB for settings and profile storage.
Disk Space Total	Displays total test set disk space in GB.
RF Temperature	Displays the current RF card temperature in degrees Celsius. RF Temperature only displays if RF is generated.
Power Supply Temperature	Displays the current power supply module temperature in degrees Celsius.
Battery Temperature	Displays the current battery pack temperature in degrees Celsius.

Display Component	Description
Slot 1 MIC284 Temperature	Displays the current PXI slot 1 controller MIC284 temperature in degrees Celsius.
Slot 1 OMAP Temperature	Displays the current PXI slot 1 controller OMAP processor temperature in degrees Celsius.
Digital Board Temperature	Displays the current PXI digital board temperature in degrees Celsius.

Control Component	Description
Format SD	<p>Formats the internal SD memory card overwriting all stored settings and profile data.</p> <ul style="list-style-type: none"> • NOTE: The user will be prompted YES or NO prior to execution of formatting. • Caution: Formatting will result in complete irretrievable loss of settings and profile data.
Secure Erase SD	Completely erases the contacts of the SD card. This can take a couple of hours to complete. Settings and Profiles will no longer be accessible.

5.5.1.B Hardware

The Hardware tab displays hardware module/board identification, version and software revision numbers for configuration control purposes.



Fig. 5-8 System Config - Hardware

Display Component	Description
RF Card ID	Displays RF card identification number.
RF Card Revision	Displays RF card revision number.
RF Firmware Version	Displays RF card firmware revision number.
Digital Board Card ID	Displays digital board card ID number.
Digital Board Card Revision	Displays digital board card revision number.
Digital Board Firmware Revision	Displays digital board firmware revision number.
Slot 1 Actel PCI FPGA Version	Displays slot1 Actel PCI FPGA version number and date.
Slot 1 Control Board Revision	Displays slot 1 control board revision number.
Slot 1 Actel JTAG GPLD Version	Displays slot1 Actel JTAG GPLD version number and date.
Power Supply Version	Displays power supply version number.

5.5.1.C UI Options

The UI Options tab controls the screen back light level and touch screen calibration utility.



Fig. 5-9 System Config – UI Options

Control Component	Description
Backlight	Move the slider to the right to increase backlight level. Move the slider to the left to reduce backlight level.

5.5.1.D Network

The Network tab controls the test set Ethernet adapter local area connection settings. The Ethernet bus is used for remote control of the test set.



Fig. 5-10 System Config – Network

Control Component	Description
IP Address	Numeric pad: IP address example entry in the format 10.200.162.76.
Subnet Mask	Numeric pad: Subnet mask example entry in the format 255.255.255.0.
Gateway	Numeric pad: Gateway example entry in the format 10.200.1.90. <ul style="list-style-type: none"> NOTE: This field is only selectable with Network Mode = DHCP
DNS Server	Connection specific Domain Name Server suffix. <ul style="list-style-type: none"> NOTE: Reserved for future use.
Network Mode	Drop down menu: Selections Network Off – Disables Ethernet adapter. Static IP - Uses entered static IP address. DHCP – Uses dynamically allocated address from DHCP server.

5.5.1.E Date/Time

The Date/Time tab controls the test set date /time clock parameters.



Fig. 5-11 System Config – Date/Time

Control Component	Description
Time	Numeric pad: Time entry in the 12 or 24 Hour format HH:MM:SS
Date	Numeric pad: Date entry in the format MM:DD:YYYY

5.5.2 Maintenance Function Window

The Maintenance Function Window is accessible via the Launch Bar. The Maintenance Function Window provides access to Diagnostics, Calibration and System Info procedures and information.

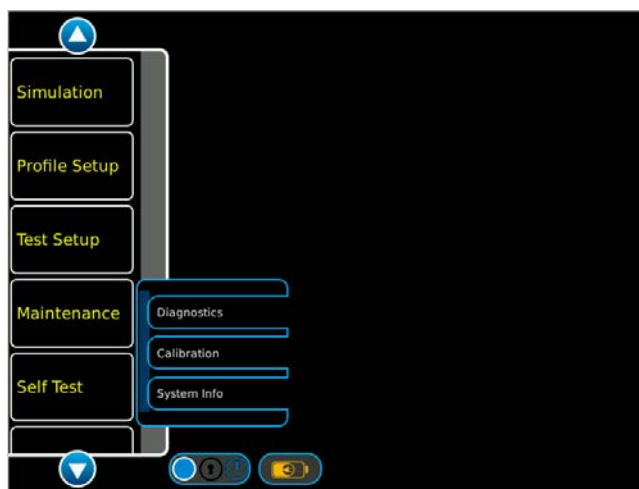

Fig. 5-12 Maintenance Function Window

5.5.3 Diagnostics Function

The Diagnostics function provides control for generating and receiving test signals, with specific power and frequency parameters.

5.5.3.A Transmit Function

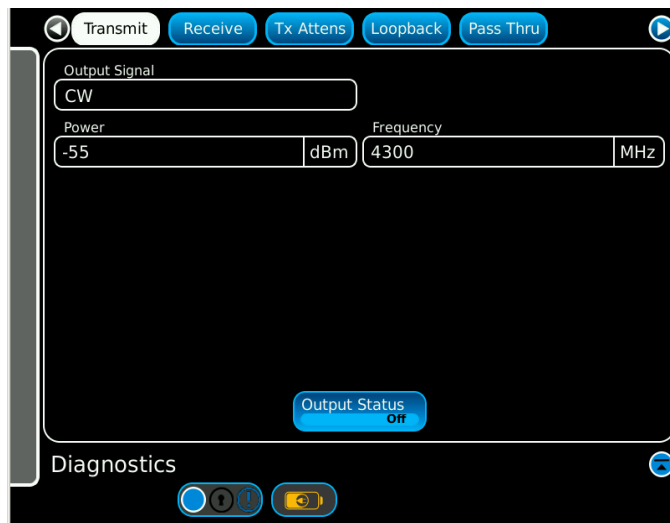

Fig. 5-13 Transmit Function

Control Component	Description
Output Signal	Drop down menu: Selections CW, FMCW or Pulse.
Power	Numeric pad: Power in dBm. Range -76 dBm to +17 dBm in 1 dB increments.
Frequency	Numeric pad: Frequency in MHz. Range 4200 to 4400 in 1 MHz increments.
Output Status	Selections On - generates test signals. Off - turns test signals off.
PRF	Numeric pad: Rate in Hz. Range 2,000 Hz to 30,000 Hz.
Pulse Width	Numeric pad: Pulse Width in ns. Range 20 ns to 400 ns.

5.5.3.B Receive Function



Fig. 5-14 Receive Diagnostics

Control Component	Description
Attenuation	Numeric pad: Attenuation in dB. Range 0 to 31 in 1 dB increments.
Gain Stage	Drop down menu: Selections OFF, ON. Turn on/off the 24 dB Gain Stage.
Power	Power displayed in millivolts.
Measuring	Activates measuring function.

Note:
 Pulse signals or gated FMCW signals are not currently supported in receive diagnostics mode.

5.5.3.C Tx Attens Function

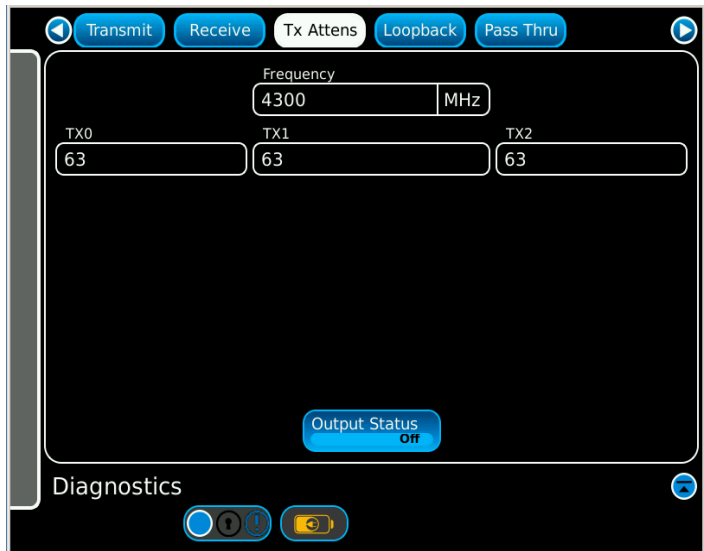

Fig. 5-15 Tx Attens

Control Component	Description
Frequency	Numeric pad: Frequency in MHz. Range 4200 to 4400 in 1 MHz increments.
TX0, TX1, TX2	Numeric pad: TX Attenuation in half dB steps. Ex: setting 31 gives 15.5 dB attenuation. Range 0 to 63 (0 to 31.5 dB)
Output Status	Selections On - generates test signals. Off - turns test signals off.

5.5.3.D Loopback

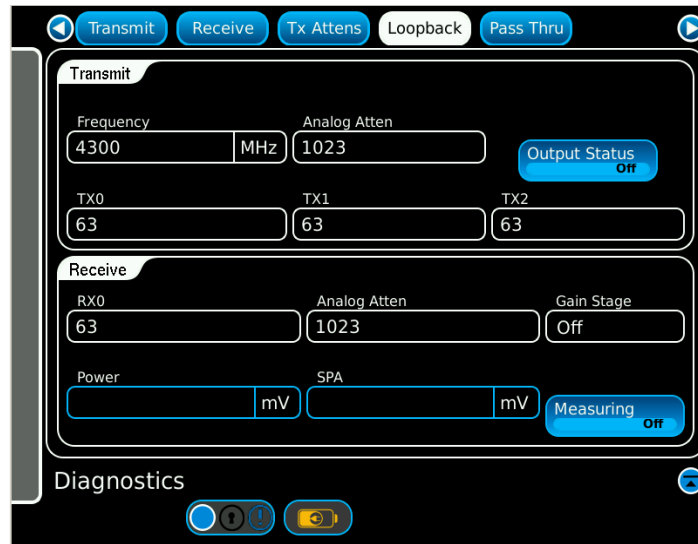

Fig. 5-16 Loopback

Control Component	Description
Frequency	Numeric pad: Frequency in MHz. Range 4200 to 4400 in 1 MHz increments.
Analog Atten	Numeric pad: TX analog attenuation. Range is 0 to 1023. Larger values give larger attenuation.
TX0, TX1, TX2	Numeric pad: TX Attenuation in half dB steps. Ex: setting 31 gives 15.5 dB attenuation. Range 0 to 63 (0 to 31.5 dB)
Output Status	Selections On - generates test signals. Off - turns test signals off.
RX0	Numeric pad: Attenuation in half dB steps. Ex: setting 31 gives 15.5 dB attenuation. Range 0 to 63 (0 to 31.5 dB)
Analog Atten	Numeric pad: RX analog attenuation. Range is 0 to 1023. Larger values give larger attenuation.
Gain Stage	Drop down menu: Selections OFF, ON. Turn on/off the 24 dB Gain Stage.
Power	Power displayed in millivolts.
SPA	Spectrum Analyzer circuit power displayed in millivolts.
Measuring	Activates measuring function.

5.5.3.E Pass Thru

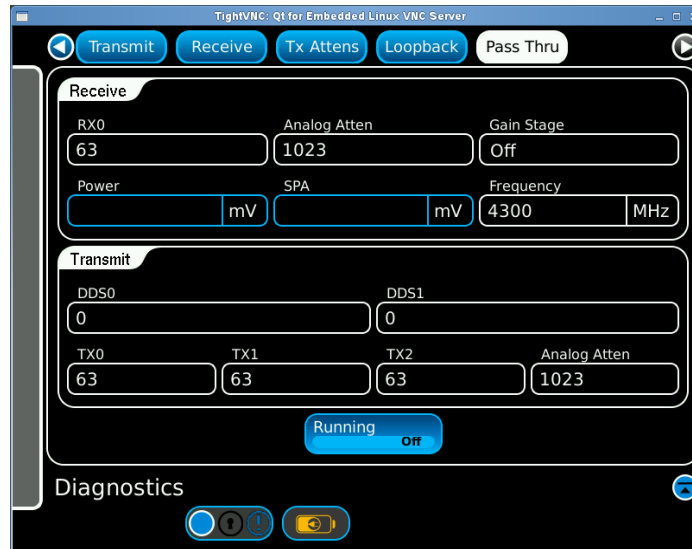

Fig. 5-17 Pass Thru

Control Component	Description
RX0	Numeric pad: Attenuation in half dB steps. Ex: setting 31 gives 15.5 dB attenuation. Range 0 to 63 (0 to 31.5 dB)
Analog Atten	Numeric pad: RX analog attenuation. Range is 0 to 1023. Larger values give larger attenuation.
Gain Stage	Drop down menu: Selections OFF, ON. Turn on/off the 24 dB Gain Stage.
Power	Power displayed in millivolts.
SPA	Spectrum Analyzer circuit power displayed in millivolts.
Frequency	Numeric pad: Frequency in MHz. Range 4200 to 4400 in 1 MHz increments.
TX0, TX1, TX2	Numeric pad: TX attenuation in half dB steps. Ex: setting 31 gives 15.5 dB attenuation. Range 0 to 63 (0 to 31.5 dB)
Analog Atten	Numeric pad: TX analog attenuation. Range is 0 to 1023. Larger values give larger attenuation.
Running	Enable/Disable power output and receive measurements.
DDS0, DDS1	Numeric pad: DDS value to write to hardware to simulate altitude. Range -200 to 20,000. Usually set identical values when driving a FMCW altimeter.

5.5.4 System Info Window

The System Info function window is accessible via the Launch Bar Maintenance function key, as a sub selection. System Info displays the hardware status of the Receive LO, Tracking Synth, SPA, Transmit LO, Offset Synth and DPLL. The indicators display clear when the respective loops are locked.



Note:

- No or very low RF input to the test set will cause the Tracking Synth and DPLL loops to indicate unlocked.
- If any indicator displays red, any UUT parameters displayed may be invalid.

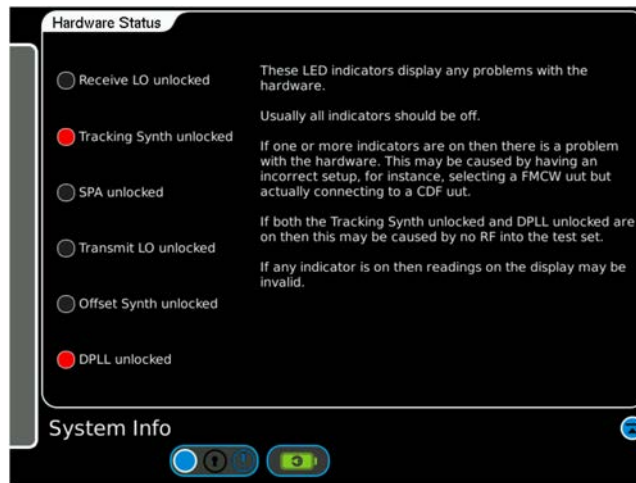

Fig. 5-18 System Info

Display Component	Description
Receive LO unlocked	Displays red when the Receiver Local Oscillator is unlocked.
Tracking Synth unlocked	Displays red when the Tracking Synth is unlocked.
SPA unlocked	Displays red when the SPA is unlocked.
Transmit LO unlocked	Displays red when the Transmit LO is unlocked.
Offset Synth unlocked	Displays red when the Offset Synth is unlocked.
DPLL unlocked	Displays red when the DPLL is unlocked.

THIS PAGE INTENTIONALLY LEFT BLANK.

Product Specifications

6

User Interface

Display 12" color LCD, sun light readable w/ back light
Controls Touchscreen

TX/RX Direct Connection Ports

Impedance 50 Ω
SWR
TX 2.0:1
RX 1.5:1
Connector
TNC x 2 (single TX/RX channel)

Receiver

RF Input Frequency

Range 4.20 GHz to 4.40 GHz

FMCW/CDF FMCW

Frequency Measurement

Range 4.20 GHz to 4.40 GHz
Accuracy ± 5 MHz

TX Power Measurement

Range 4 mW (+6 dBm) to 2 W (+33 dBm)
Accuracy ± 2 dB

FM Sweep Rate Measurement

Range 50 Hz to 400 Hz
Accuracy ± 5 Hz

FM Deviation

Range ± 20 MHz to 100 MHz
Accuracy ± 5 MHz

Pulse

Frequency Measurement

Range 4.20 GHz to 4.40 GHz
Accuracy ± 10 MHz

TX Power Measurement

Range 1 mW (0 dBm) to 300 W
(+54 dBm) peak
Accuracy > 50 ns ± 2 dB
Accuracy < 50 ns ± 3 dB

TX Pulse Width Measurement

Range 20 ns to 5 μ s
Accuracy ± 10 ns

TX Pulse PRF Measurement

Range 2 kHz to 30 kHz
Accuracy $\pm 5\%$

Linear Altitude Rate

Range 1 to 120,000 fpm
Altitude update rate 10Hz max

RF Sample Port (at carrier frequency)

Attenuation -46dBc typical

Test Cable (automatic compensation)

Test Cable Length 1 to 25 ft.
Test Cable Loss 0 to 9.9 dB
Antenna Couplers TX and RX
Coupler Loss Compensation 0 to 19.9 dB

External Attenuation (automatic compensation)

Attenuation Range 0 to 20 dB (UUT:TX)
0 to 50 dB (UUT:RX)

Altitude Simulation

Range 5 to 10,000ft.¹ (at test set connectors, plus interconnecting cables)
Optional Range 16,000 and 25,000 ft as discrete altitude selections
Resolution 5 ft (standard range only)
Accuracy ± 1 ft. $\pm 1\%$ of simulated altitude
Altitude switching time 5ms max (Typically < 3 ms)

Altitude Offset

-100 to 100 ft.

Loop Loss

Manual Mode

Range -35 to -135 dB (0 to 50 ft²)
-55 to -135 dB (55 to 5000 ft²)
-60 to -135 dB (> 5000 ft²)
(dependent upon cable loss, coupler loss and external attenuation)
Accuracy ± 2 dB -35 to -95 dB @ 4.30 GHz
 ± 3 dB -95 to -135 dB @ 4.30 GHz
 ± 2 dB typical (4.20 to 4.40 GHz, referenced to 4.30 GHz)

Flatness

Auto Mode

Computed path loss based on altitude, scattering, cables, couplers and offset.

RF Level Offset (auto)

-20 to +20 dB

Frequency Stability

± 1 ppm

DC Input

Input voltage 11 – 32 VDC
Input power 75 W max
Input current 5 A max

Specifications

Environmental Certifications

Operating Temperature	MIL-PRF-28800, Class 2
	-10° to 55° C (14° to 131° F)
Storage Temperature	MIL-PRF-28800F, Class 2
	-51° to 71° C (w/battery removed) (-59.8° to 159.8° F)
Operational Humidity	MIL-PRF-28800F, Class 2
Storage Humidity	MIL-PRF-28800F, Class 2
Vibration Limits	MIL-PRF-28800F, Class 2
Shock, Functional	MIL-PRF-28800F, Class 2
Shock Resistance	MIL-PRF-28800F, Class 2
Transit Drop	MIL-PRF-28800F, Class 2
Bench Handling	MIL-PRF-28800F, Class 2
Watertight	MIL-PRF-28800F, Class 2
Drip Proof	MIL-PRF-28800F, Class 2
Sand and Dust ³	MIL-PRF-28800F, Class 2
Salt Atmosphere ³	MIL-PRF-28800F, Class 2
Altitude Operating	MIL-PRF-28800F, Class 2
	0 – 4600m
Altitude Non-Operating	4,600m
Explosive Atmosphere	MIL-STD-810F, Method 511.4
Solar Radiation	MIL-PRF-28800F, Class 2
Fungus Resistance ³	
Safety Compliance	EN/UL-61010-1, 3 rd Edition

WEEE

RoHS

EMC

EN/IEC 61326-1: 2013

Supplied External AC to DC Converter (Indoor Use)

Operating Temperature	5° to 40° C (41° to 104° F)
Storage Temperature	-20° to 71° C (-4° to 159.8° F)
Altitude	< 10,000

Size:

<i>Test set case</i>	18.7" x 16.4" x 8.5" 47.5 cm x 41.7 cm x 21.6 cm
<i>w/ standard access</i>	33.75" x 28.50" x 16.25" 85.8 cm x 72.4 cm x 41.3 cm

Weight:

<i>Test Set Only</i>	32 lbs., 14.52 kg
<i>Kit</i>	88 lbs., 39.92 kg

Notes:

- 1) *Minimum simulated altitude will be 5ft + test cable delay + Altitude Offset setting*

- 2) *Actual simulated altitude with 0 ft Altitude Offset. If Altitude offset is used, subtract the altitude offset from the actual simulated altitude to determine break points.*
- 3) *Tests to be performed with unit in transit case and lid closed.*

Abbreviations



A

Table A-1 Abbreviations

Term	Description
A/C	Aircraft
A2D	Analog to Digital
AC	Alternating Current
ADPLL	All Digital Phase Locked Loop
AF	Analog Frequency
ANT	Antenna
APLL	Analog Phase Locked Loop
ASA	Actual Simulated Altitude
BPF	Bandpass Filter
Cal	Calibration
CPU	Central Processing Unit
CW	Continuous Wave
D2A	Digital to Analog
dB	deci-Bel (decibel)
DA	Decision Altitude
DC	Direct Current
DH	Decision Height
DMM	Digital Multimeter
DSA	Desired Simulated Altitude
EMI	Electromagnetic Interference
ESD	Electro Static Discharge
FPGA	Field Programmable Gate Array
FOD	Foreign Objects & Debris
GEN	Generator
GHz	Giga-Hertz
GPIB	General Purpose Interface Bus
Hz	Hertz
I/O	Input/Output
IPMB	Intelligent Platform Management Bus
KHz	Kilo-Hertz (kHz)
LIB	Lithium-Ion Battery
LPF	Lowpass Filter

Abbreviations

Term	Description
MHz	Mega-Hertz
P/N	Part Number
PCI	Peripheral Component Interconnect
PCIe	Peripheral Component Interconnect Express
PRF	Pulse Repetition Frequency
PWM	Pulse Width Modulation
PXI	PCI eXtensions for Instrumentation
RF	Radio Frequency
RSSI	Residual Signal Strength Indicator
SATA	Serial Advanced Technology Attachment
sRIO	Serial Rapid IO
T/R	Transmit/Receive (also Tx / Rx)
TACH	Tachometer
UI	User Interface
USB	Universal Service Bus
Ver	Verification
VGA	Video Graphics Adapter

Terminology

B

Table B-1 Terminology

Term	Description
Actual Simulated Altitude (ASA)	Displays the current altitude simulated by the test set for manual or profile operation. During an altitude simulation, the ASA is the altitude used to determine the accuracy of the altitude displayed by the Radio Altimeter System.
Altitude Rate	The rate of climb or descent. Also known as Vertical Speed
Altitude Trip	Usually relating to ARINC 552 radio altimeters, a relay switched output to control/signal connected systems such as auto-land, that a specific altitude has been reached.
Approach	The landing phase of a flight
ARINC	Aeronautical Radio Incorporated. A U.S. based aeronautical standards organization, originally owned collectively by several airlines. ARINC standards mainly address the system interface, whereas RTCA standards address system design.
ARINC 552	An earlier ARINC standard defining the interface of analog radio altimeters. Typically used in air transport installations.
ARINC 707	A later ARINC standard defining the interface of digital radio altimeters. Typically used in air transport applications
Audio Frequency Altitude	An Audio Frequency that is proportional to altitude.
CDF FMCW	Constant Difference Frequency - Frequency Modulated Continuous Wave A Thales proprietary technique that alters the sweep rate in proportion to altitude maintaining a constant difference or beat frequency in a narrow bandwidth receiver
DC Altitude	A DC voltage that is proportional to altitude, defined by ARINC-552. Used to drive analog altitude indicators and other sub systems.
Decision Height	An altitude, at which the pilot is alerted by the radio altimeter. Typically used to make landing decisions
Desired Simulated Altitude (DSA)	Numeric Pad. During an altitude simulation, this field will be the same as the Start Altitude until the Altitude Pause button is pressed, and a new DSA is entered. The DSA is the altitude that the user would like to achieve. NOTE: Due to the available path lengths in the ALT-9000, the exact DSA may not be achievable, so the closest achievable altitude will be used and displayed as the ASA. This field is only active during Altitude Pause.
De-rotation	The point after touch down when the pilot lowers the nose of the aircraft so the front wheels touch down.
DH Bug	The decision height setting pointer on dial type analog altitude indicators. Also known as the DH index on analog tape indicators and EFIS
DH Set	The knob on an analog altitude indicator that the pilot uses to set the DH bug. Also known as DH adjust.
EFIS	Electronic Flight Instrument System

Terminology

Term	Description
Feeder Cable	The RF Coax Cable linking either the transmitter port to the TX antenna or the receiver port to the RX antenna
Flag	A red mechanical bar or a graphical bar that obscures part of the altitude display to indicate that altitude information is not available or unreliable.
FMCW	Frequency Modulated Continuous Wave Triangular wave frequency modulated technique that produces a difference or beat frequency in a wide bandwidth receiver, that is proportional to altitude
FM Deviation	The limits of deviation of the 4.3 GHz (center carrier) signal, during frequency modulation, expressed in MHz.
Go- Around	A missed approach procedure
Installation Rack	The mounting tray for the LRU that accommodates a mating connector for all discrete and RF signals. The aircraft wiring connects to the installation rack, which typically provides screw down retention for the LRU that allows easy removal.
Integrity Monitor	The Built In Test Equipment that monitors correct operation of an LRU and advises module failure either by dedicated indicators on the LRU front panel or via a BITE word from the test port.
Label 164	ARINC 429 binary data word for radio height. An altitude data output format for ARINC -707 radio altimeters. May also be output on ARINC-707 radio altimeter test ports.
Label 165	ARINC 429 BCD data word for radio height. An altitude data output format for ARINC -707 radio altimeters. May also be output on ARINC-707 radio altimeter test ports.
Leg	A linear altitude ramp, either climbing, level altitude or descending. 1. If climbing or descending the ramp is defined by start altitude, stop altitude and altitude rate. 2. If level (start altitude= stop altitude), the ramp is defined by duration.
Loop Gain Margin	The reflected signal amplitude seen at the radio altimeter receiver that is X dB's above the receiver MDS
LRRA	Low Range Radio Altimeter. Range typically up to 8,000 ft
LRU	Line Replaceable Unit. Would normally refer to the radio altimeter transmitter/receiver unit however, an indicator is also an LRU.
MDS	Minimum Discernible Signal Level. A term used to express radar receiver sensitivity in -dBms
Profile	A sequence of legs forming a simulated flight path i.e. approach
Pulse Radio Altimeter	The altimeter measures the time delay between a transmitted RF pulse and the reply from the ground.
Sweep Rate	The rate of the triangular frequency modulation of an FMCW radio altimeter expressed in Hz. This is usually constant for a given system. CDF FMCW systems will have a saw tooth frequency modulation, where the sweep rate is proportional to altitude.
Test Port	A port provisioned on some radio altimeters, that may provide the following. 1. BITE data output 2. Radio Height in the form of DC altitude, Audio Frequency Altitude or Digital Altitude. 3. Analog trips 4. System flags
UUT	Unit Under Test



22149669 / Rev. 001
Part of CD: 22149666
April, 2022
English