

To buy, sell, rent or trade-in this product please click on the link below:
<http://www.avionteq.com/GE-Everest-XLG3-VideoProbe-NDT-Video-Borescope.aspx>



Everest XLG3™ VideoProbe® System



Operating Manual

Copyright 2009 GE Inspection Technologies, LP. All rights are reserved. No one is permitted to reproduce or duplicate, in any form, this manual or any part thereof without permission from GE Inspection Technologies, LP.

Software in this product is copyright GE Inspection Technologies, LP, or its vendors. All rights are reserved. The software is protected by United States of America copyright and international treaty provisions applicable worldwide. Under such laws, the licensee is entitled to use the copy of the software incorporated with this instrument as intended in the operation of the product in which it is embedded. The software may not be copied, decompiled, reverse-engineered, disassembled, or otherwise reduced to human-perceivable form. This is not a sale of the software or any copy of the software; all right, title, and ownership of the software remains with GE Inspection Technologies, LP, or its vendors.

VideoProbe, ShadowProbe, and StereoProbe are registered trademarks of GE Inspection Technologies, LP. XL PRO, XLG3, iView, All-Way, QuickChange, and Steer-and-Stay are trademarks of GE Inspection Technologies, LP.

NETGEAR is a registered trademark of NETGEAR, Inc. Firefox is a registered trademark of the Mozilla Foundation.

MPEG Layer-3 audio coding technology licensed from Fraunhofer IIS and Thomson.

GE Inspection Technologies, LP, assumes no responsibility for any injury to anyone, or for any illegal or improper use of the product, that may result from failure to use this product in accordance with the information published in this manual.

This device complies with Part 15 of the FCC Rules. Operation is subject to the following two conditions: (1) this device may not cause harmful interference, and (2) this device must accept any interference received, including interference that may cause undesired operation

FCC Statement

This product has been tested and complies with the specifications for a Class A digital device, pursuant to Part 15 of FCC Rules. These limits are designed to provide reasonable protection against harmful interference in a residential installation. This equipment generates, uses, and can radiate radio frequency energy and, if not installed and used according to the instructions, may cause harmful interference to radio communications. However, there is no guarantee that interference will not occur in a particular installation. If this equipment does cause harmful interference to radio television reception, which is found by turning the equipment off and on, the user is encouraged to try to correct the interference by one or more of the following measures:

- Reorient or relocate the receiving antenna
- Increase the separation between the equipment or devices
- Connect the equipment to an outlet other than the receiver's
- Consult a dealer or an experienced radio/IV technician for assistance

FCC Radiation Exposure Statement

This equipment complies with FCC radiation exposure limits set forth for an uncontrolled environment. This equipment should be installed and operated with minimum distance 20 cm between the radiator and your body.

Safety Notices

Caution: To reduce the risk of fire, use only No.26 AWG or larger telecommunication line cord.

Do not use this product near water, for example. in a wet basement or near a swimming pool.

Contact Information

Service

To obtain service for your system, call one of the service centers below. If the problem cannot be corrected over the phone, you will be given a Return Materials Authorization Number (RMA) for shipment to the service center.

Always contact a GE Inspection Technologies service center for an RMA prior to returning any products for service or repair.

USA	GE Inspection Technologies Product Service Dept. 721 Visions Drive Skaneateles, NY 13152	Phone: 888-332-3848 315-554-2000 ext. 1 Fax: 866 899 4184
Germany	GE Inspection Technologies GmbH Lotzenäcker 4 72379 Hechingen	Phone: +49 7471 98820 Fax: +49 7471 9882 30
Hong Kong	GE Inspection Technologies (HK) Ltd. Unit 1602, 16/F Sing Pao Building 101 King's Road North Point Hong Kong	Phone: +852 2877 0801 Fax: +852 2877 0868

Web Site

www.ge.com/inspectiontechnologies

Contents

Contact Information	iii
1 - Introduction	1
About This Manual	1
Getting Help	1
System Overview	2
Frequent Tasks	3
About the Battery	4
About the Image Processing Package	4
About the Network Package	5
About the Menu Directed Inspection Package	6
Controls, Indicators, Connectors, etc.	7
Navigating the Menus	15
Restoring Factory Defaults	16
Safety Information	17
Informations sur la sécurité	20
2 - Safe Powering and Grounding	23
Overview of Safe Powering and Grounding	23
Verifying AC Earth Ground Path	24
Grounding With a DC Source (Battery)	25
Special Grounding Situations	25
3 - Setting Up and Putting Away the System	27
Setting Up the System	27
Changing the Probe	30
Changing the Optical Tip	31
Putting the System Away	32
Communicating to a PC Through a Router or Network	34
Manual Entry - Wireless Access Point	37
4 - Setting Up the Software	39
Reviewing Settings for Audio	39
Reviewing Settings for Image Format and Quality	40
Reviewing the Setting for Video Quality	41
Reviewing Settings for Text Color	42
Reviewing Settings for a Logo	42
Reviewing Settings for Measurement	43
Reviewing Settings for the System	44
Reviewing Settings for Communications	45

5 - Capturing Images and Videos	47
Process Overview	47
Steering the Probe	49
Freezing an Image	50
Working With a Recalled Image	51
Working With a Split Screen	52
Adjusting the Brightness	53
Reducing “Noise” in Dark Images	54
Correcting Wide-Angle Distortion	56
Lengthening Exposure Time	57
Enhancing Contrast	58
Zooming	58
Inverting an Image	59
Annotating With Text or Arrows	60
Saving an Image	65
Working With Videos	67
6 - Managing Files & Communicating With Other Computers	73
About the Thumbnail Screen	73
Working With Removable Storage Devices	74
Recalling a File	75
Creating, Renaming, or Deleting Folders	75
Copying Files	75
Deleting Files	76
Renaming a File	76
Archiving (Copying) Files to a DVD	77
Using the Desktop	78
Sharing Files or Live Video With a PC	80
7 - Measuring Features and Defects	87
About Measuring	87
3D Phase Measurements	91
Stereo Measurements	96
Shadow Measurements	104
Comparison Measurements	110
Verifying Measurement Tips	112
Troubleshooting Measurements	113
8 - Maintenance	115
Inspecting and Cleaning the System	115
Replacing the Lamp	118
Checking and Replacing the Fuses	120
Maintaining the Battery	122
Replacing the Internal Memory Card	125

- 9 - Troubleshooting 127**
 - Image 127
 - Probe 128
 - Power 128
 - Lamp 128
 - Software 129
 - DVD Recording 129
 - Storing Data to USB Thumb Drive 129

- A - Specifications 131**
- B - Agency Certifications 135**
- C - Chemical Compatibility 137**
- D - Warranty 139**
- E - Menu Trees 141**
- F - Optical Tips 147**
 - 6.2mm Internal Working Channel Feature 150

- G - Environmental Compliance 151**

- Index 153**

1 Introduction

About This Manual	1
Getting Help	1
System Overview	2
Frequent Tasks	3
About the Battery	4
About the Image Processing Package	4
About the Network Package	5
About the Menu Directed Inspection Package	6
Controls, Indicators, Connectors, etc.	7
Navigating the Menus	15
Safety Information	17
Informations sur la sécurité	20

About This Manual

This manual is written for visual inspection technicians who have a basic understanding of inspection principles and practices, and who are familiar with basic computer operations (such as using a mouse and managing electronic files and folders), but who may not have experience with a video borescope.

The manual provides a product overview, step-by-step procedures, and reference information. It does not include repair information.

To ensure operator safety, read and understand this manual before using the system.

Getting Help

Beyond this manual you can get product help in several ways:

- **Training**

Introductory in-person training is free with your system purchase. Additional training is available for a fee. Contact GE Inspection Technologies.

- **Phone**

For phone numbers, see “Service” on page iii.

System Overview

The rugged and dependable Everest XLG3™ VideoProbe® system is an advanced video-based flexible borescope used for remote visual inspection.

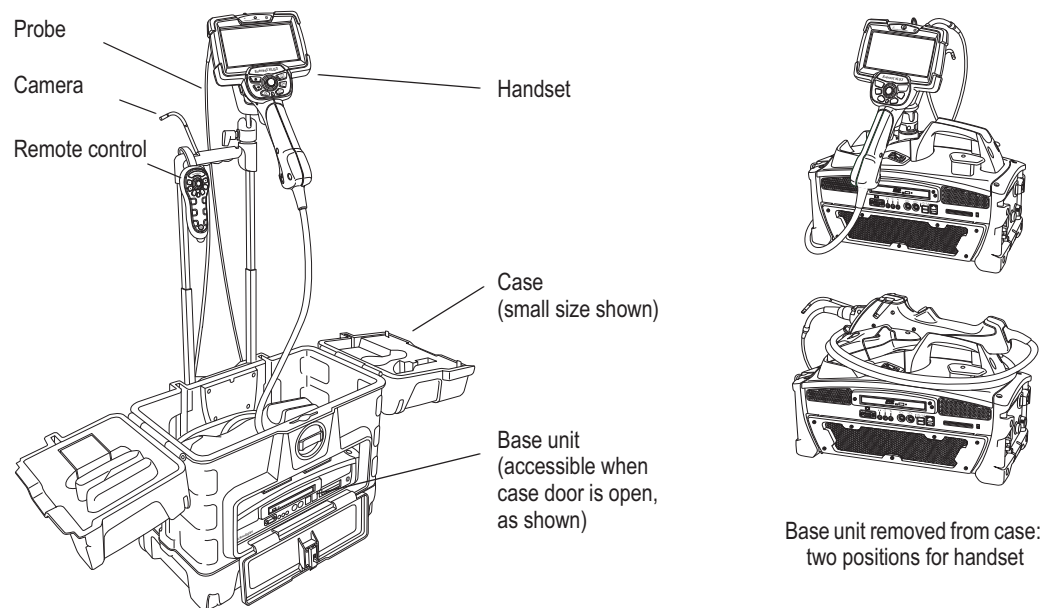
Working through access passages, the XLG3 system delivers high-resolution images of internal details of turbine engines, airframes, automotive engines, piping, vessels, wind-turbine gear boxes, underwater structures, etc.

The probe's fiberoptic bundle illuminates the inspection area with light generated by a 75-watt high-intensity discharge (HID) arc lamp in the base unit. At the end of the probe, a miniature camera assembly converts the image into an electronic image, and sends it back through the probe. The system displays the image on the handset. No focusing is required, because the XLG3 system contains a fixed-focus optical system with a large depth of field.

If your system is equipped with measurement capability, you can measure defects and features.

The XLG3 system is compatible with various removable storage devices: DVD-R, DVD+R, compact Flash cards (Type 1), USB thumb drives, portable drives — most compatible USB-based or compact Flash card-based devices.

With our QuickChange™ interchangeable probes, you can quickly reconfigure the system for maximum productivity.



Frequent Tasks



Setting Up the System — Summary

For details, see [“Setting Up the System”](#) on page 27.

1. Open case’s lids and front door.
2. Verify safe powering and grounding.
Inspect ground prong on power cord.
3. Connect to AC power, or attach battery.
4. Turn on power switch.
5. Remove insertion tube from storage reel.
6. Unwrap handset cable, and remove handset from case.
7. Install optical tip, accessories, and peripheral devices.



Capturing Images — Summary

For details, see [“Capturing Images and Videos”](#) on page 47.

1. Steer probe until desired view is displayed.
Position camera by moving joystick toward desired feature.
2. Freeze the image.
When desired image is displayed, press .
3. Save the image.
Press . Select **Return**. The image is saved.

Recording Video — Summary

For details, see [“Working With Videos”](#) on page 67.

1. Start recording video.
Press . Select **Start Recording**.
2. Stop recording video.
Press . Select **Video Record > Stop Recording**.

Putting the System Away — Summary

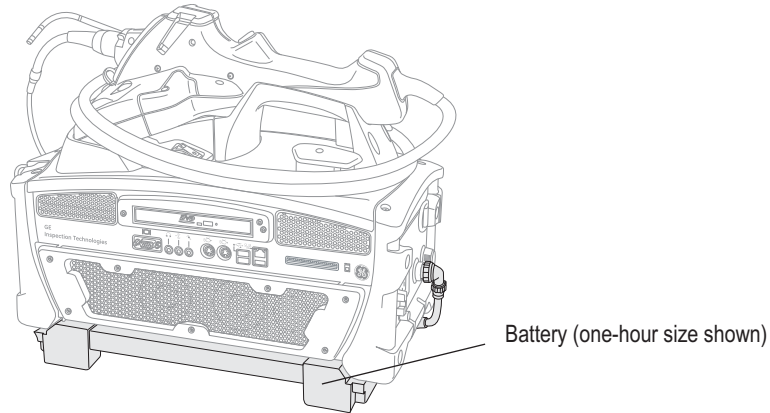
For details, see [“Putting the System Away”](#) on page 32.

1. Straighten bending neck.
2. Turn off system, and disconnect from power source.
3. Detach peripheral devices and accessories.
4. Return insertion tube to storage reel, and wrap handset cable.
5. Store system and components in case.

About the Battery

Batteries for the XLG3 system are optional. Two sizes are available: one-hour and two-hour.

To learn about removing, charging, or installing the battery, see [“Maintaining the Battery”](#) on page 122.



About the Image Processing Package

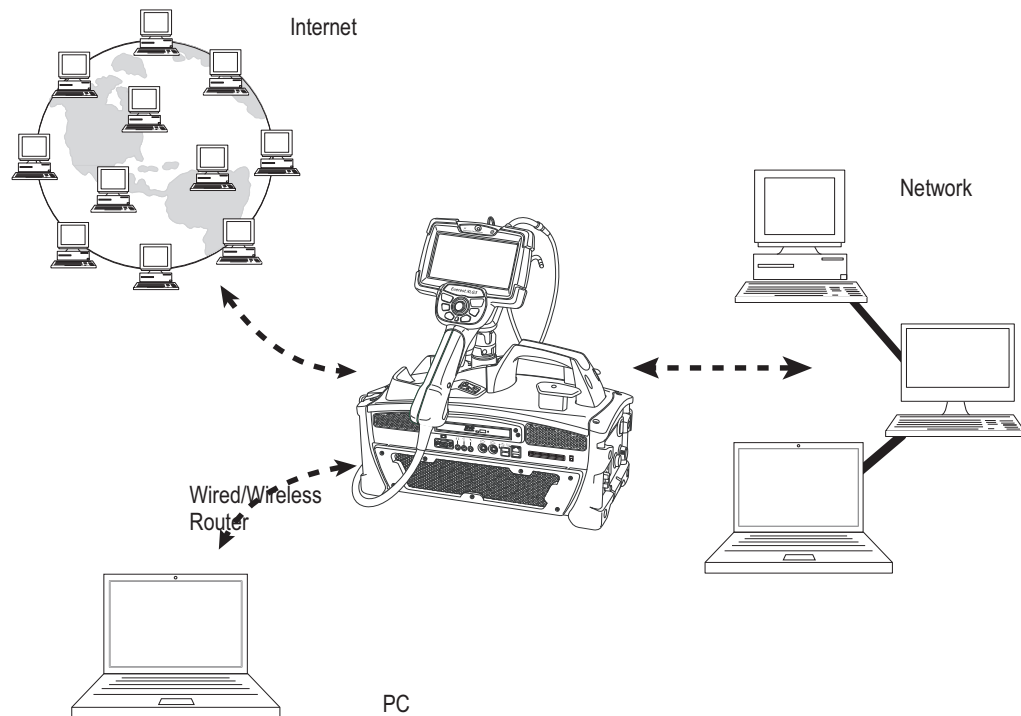
The image processing package — which lets you enhance images under particular circumstances — includes the following features.

Feature	Description	Details
Distortion correction	Flattens image edges when you use a 120° optical tip.	“Correcting Wide-Angle Distortion” on page 56
Adaptive noise reduction	Sharpens images when the probe is in a dark area.	“Reducing “Noise” in Dark Images” on page 54

About the Network Package

The optional network software package — which delivers communication, file sharing, and network functions for the XLG3 system — includes the following features.

Feature	Description	Details
PC and network communications	You can communicate between the XLG3 system and a PC via a wired or wireless network connection. Then you can browse the XLG3 system from the PC and view, download, or upload files. You can also view live video from the PC ("video streaming"). Note: The XLG3 system cannot be connected directly to a PC. See page 34.	"Communicating to a PC Through a Router or Network" on page 34 "Reviewing Settings for Communications" on page 45 "Sharing Files or Live Video With a PC" on page 80 "To Save an Image" on page 66
Virtual desktop	You can manage files and access other applications via a graphical interface.	"Using the Desktop" on page 78
Internet browsing	You can access web pages for viewing, downloading, or uploading.	
E-mail	You can access any outside e-mail service to send e-mail with files attached.	
Internal WiFi	A built-in wireless card lets you connect to a wireless access point.	



About the Menu Directed Inspection Package

Menu Directed Inspection (MDI) is the first software tool to standardize the inspection process in the NDT industry. MDI software helps guide inspectors through the inspection process and intelligently auto-generates a report—saving time, improving quality and increasing productivity.

Menu Directed Inspection (MDI) software provides an advantage and convenience during the inspection process. MDI makes labeling images and videos easier and automatically generates reports from the VideoProbe within a few steps.



Benefits to using MDI include:

- Standardized Inspection Lists.
- Consistent Report Creation in MS Word format
- Data Management
- Decreased reporting time by up to 70%
- Increased speed and ease of sharing data
- Reduction of errors with guided inspections

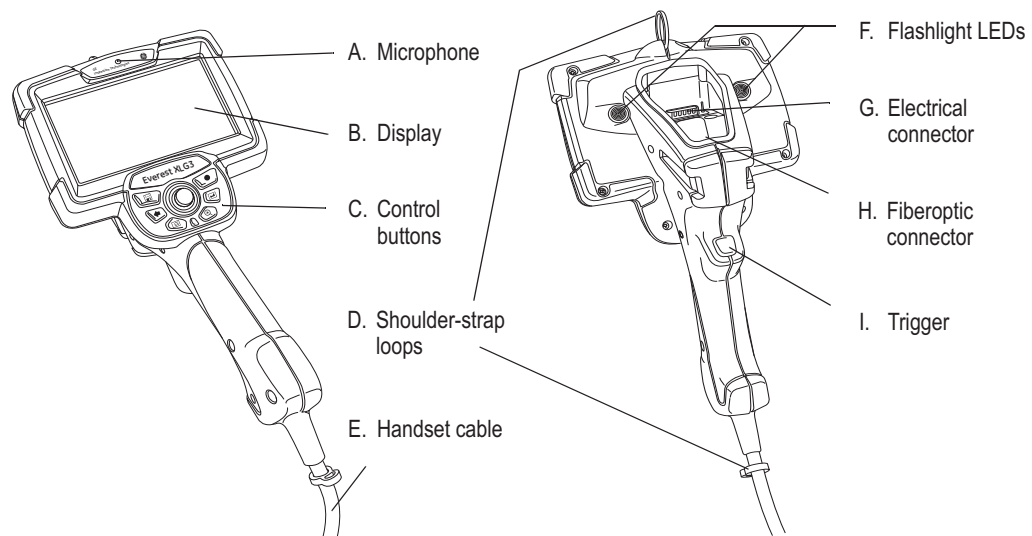
Controls, Indicators, Connectors, etc.


This section describes the controls, indicators, connectors, and other key elements for each main system component:

- “[Handset](#)” on page 7
- “[Control Buttons](#)” on page 8
- “[Probe](#)” on page 9
- “[Base Unit](#)” on page 10
- “[Case](#)” on page 14

Handset

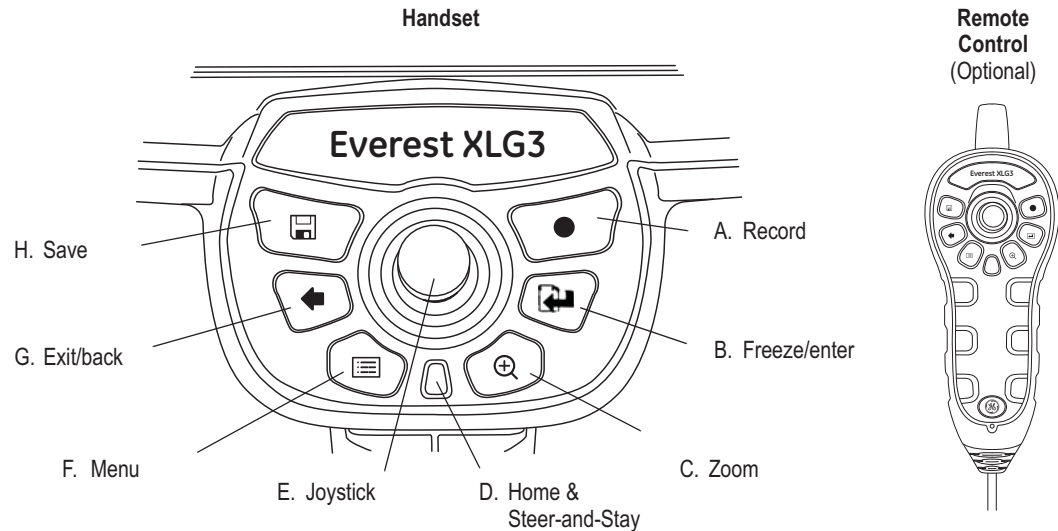
The handset is your interface to the XLG3 system.



Item	Description
A. Microphone	Lets you record voice comments for video or still images.
B. Display	Large, bright, high-resolution wide-VGA LCD screen.
C. Control buttons	For details, see “ Control Buttons ” on page 8.
D. Shoulder-strap loops	Strap is an optional accessory.
E. Handset cable	Plugs into the base unit. Powers the handset, enables communication with the base unit, and conducts light via a fiberoptic bundle from the lamp to the handset.
F. Flashlight LEDs	Provide light for reading or writing. See “ To Turn the Flashlight On and Off ” on page 29.
G. Electrical connector	Enables communication between base unit, handset, and probe.
H. Fiberoptic connector	Couples light to the probe.
I. Trigger	Same functions as the freeze/enter button  (item B. on page 8).

Control Buttons

The control buttons are conveniently located directly below the handset display. The same controls are available on the optional remote control.



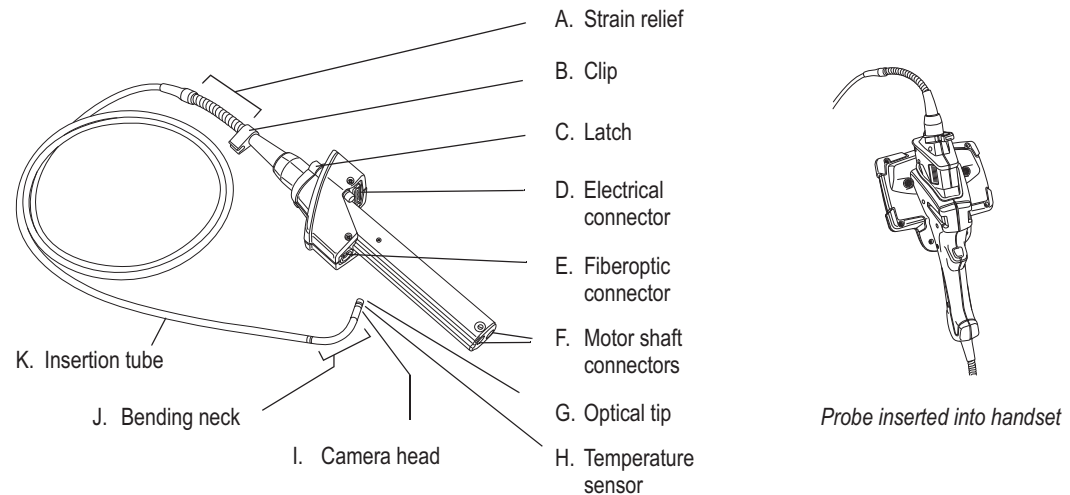
Item	Description
A. Record ●	Starts and pauses video recording. See "Working With Videos" on page 67.
B. Freeze/enter ←	Performs same functions as the trigger (item I. on page 7). <ul style="list-style-type: none"> Freezes and unfreezes images. Selects highlighted items. One-click report (see "Menu-Directed Mode")
C. Zoom ⊕	Changes the zoom level. See "Zooming" on page 58.
D. Home & Steer-and-Stay	Performs two functions: <ul style="list-style-type: none"> Home (press and hold). See "To Straighten the Bending Neck (HOME)" on page 49. Steer-and-Stay (press quickly). See "To Hold the Bending Neck in Place (Steer-and-Stay Mode)" on page 49.
E. Joystick	Moves the probe tip, pans around zoomed images, moves through menus, and navigates the desktop.
F. Menu ☰	Opens and exits menus. See "Navigating the Menu" on page 15.
G. Exit/back ←	Exits a menu or operation.
H. Save 💾	Opens the save menu. See "Saving an Image" on page 65.
I. Restore factory defaults ● + 💾 (5 seconds)	Restores factory defaults for system settings. See "Restoring Factory Defaults" on page 16.


Probe

The probe is the flexible eye of the system. Various probe models are available, with insertion tubes of different diameters and different lengths.

Diameter (mm)	Length (m)
3.9	2.0, 3.0
5.0	2.0, 3.0, 4.5
6.1	2.0, 3.0, 4.5, 6.0, 8.0, 9.6
6.2 Working Channel	3.2
8.4	2.0, 3.0, 4.5, 6.0, 8.0, 9.6

You can change probes quickly. You can also travel lighter by carrying one system and a spare probe rather than a complete spare system.



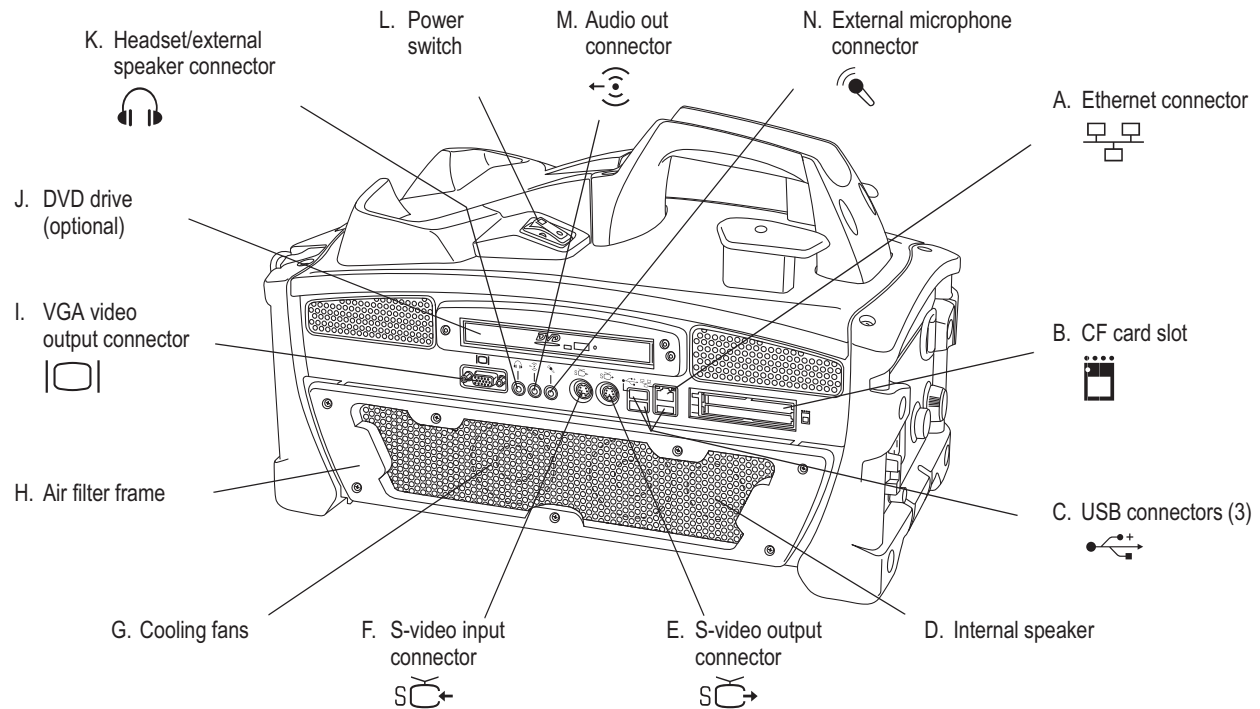
Item	Description
A. Strain relief	Allows the insertion tube to twist up to 180 degrees in either direction.
B. Clip	Holds probe end when not in use.
C. Latch	C-shaped piece that locks the probe in the handset.
D. Electrical connector	Enables communication between base unit, handset, and probe.
E. Fiberoptic connector	Couples light from the handset into the insertion tube.
F. Motor shaft connectors	For controlling the articulation cables.
G. Optical tip	Removable part containing unique precision optics. For a list of available tips, see "Optical Tips" on page 147.
H. Temperature sensor	For 6.1 mm probes only. Displays a warning symbol and beeps when temperature at the probe tip approaches or exceeds operating temperature limits. For an example of the warning symbol, press  , and select Setup > Temp Sensor.
I. Camera head	Made of titanium for superior protection. Contains a high-resolution, durable camera that provides clear, true-color images.
J. Bending neck	The articulating section of the insertion tube.
K. Insertion tube	A woven tube of tungsten wire that protects the electrical conductors and the light-transmission fibers. Conducts light to the inspection area, and returns digital images.

Base Unit

The base unit is the XLG3 system's communications center. It processes still images and video, manages data, and connects to the external world with the optional network package (via the front panel).

The base unit houses a processing board (CPU), system memory, power supply, 75-watt high-intensity discharge (HID) arc lamp, and an integrated reel that can store even the longest insertion tubes.

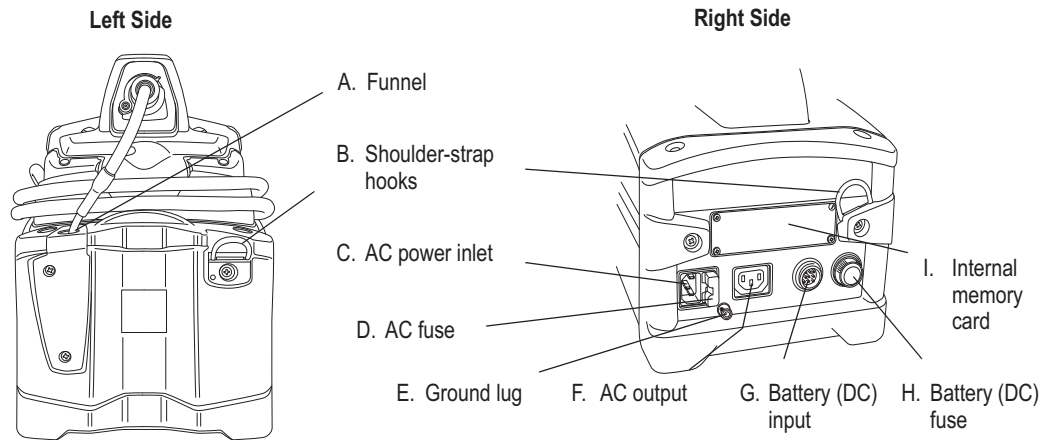
Base Unit, Front



Item	Description
A. Ethernet connector	For connecting to a network or to the Internet with the optional network package.
B. CF card slot	For saving images and videos onto a compact Flash card.
C. USB connectors (3)	For connecting various devices: a keyboard, a mouse, a memory stick, or other removable storage devices. All three connectors support USB 2.0 data rates and are compatible with USB 1.1 devices. You can connect or disconnect a keyboard or mouse any time.
D. Internal speaker	For playback of comments that were saved with images or videos. The menu-driven volume control affects this output.
E. S-video output connector	For connecting a cable to the "video in" connector of a peripheral device, such as an external monitor or recorder. S-video cables are available as accessories.
F. S-video input connector	For connecting a cable to the "video out" connector of a peripheral device, such as a camera. Allows the XLG3 system to capture, manipulate, annotate, and store images and videos from external sources. When the system detects external input, it displays that input automatically. S-video cables are available as accessories.
G. Cooling fans	For system ventilation.
H. Air filter frame	For an optional air filter.

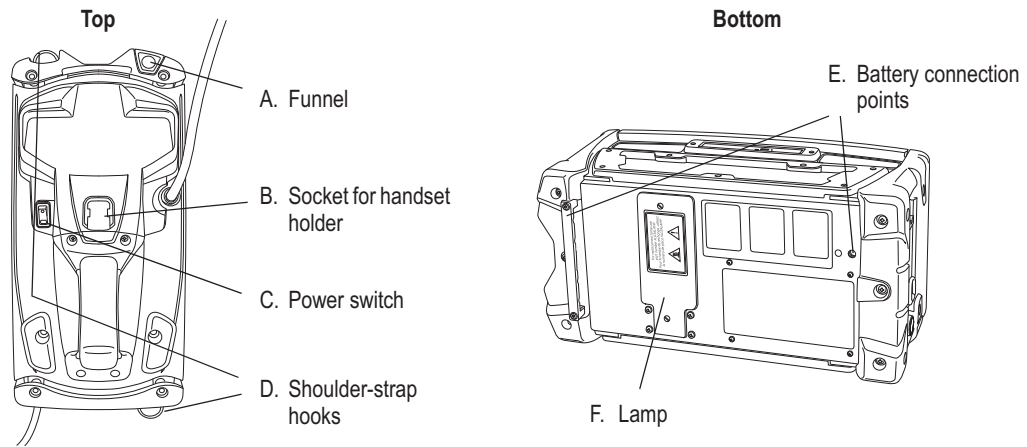
Item (cont.)	Description (cont.)
I. VGA video output connector	For connecting a PC-type monitor.
J. DVD drive (optional)	For storing video files.
K. Headset/external speaker connector	3.5 mm phone jack for a standard stereo headset or an external speaker. The menu-driven volume control affects this output. If headset is plugged in, the internal speaker is automatically disabled.
L. Power switch	Turns the system on and off.
M. Audio out connector	3.5 mm phone jack for a recording device (VCR, digital video tape recorder, etc.), or for powered speakers with their own volume control. Transmits line-level output signals (~2V RMS max). The menu-driven volume control does not affect this output.
N. External microphone connector	3.5 mm phone jack for a headset microphone or standalone microphone. An external microphone has the same function as the built-in microphone. When an external microphone is plugged in, the system automatically uses it for audio recording rather than the built-in microphone.

Base Unit, Sides



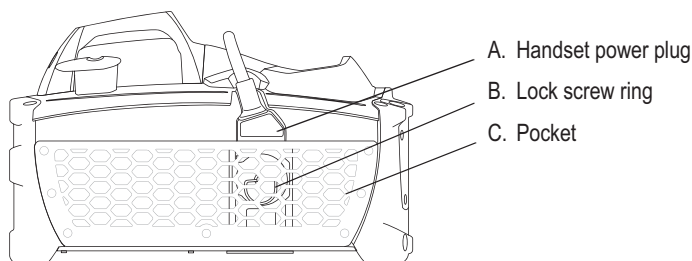
Item	Description
A. Funnel	Guides the insertion tube into the storage reel.
B. Shoulder-strap hooks	Strap is included.
C. AC power inlet	For connecting the power cord.
D. AC fuse	Protects the circuitry when using AC power.
E. Ground lug	Provides an earth ground if one is not available through the AC outlet.
F. AC output	IEC-type F connector. The voltage and frequency of the power available at the AC output is the same as the voltage and frequency applied to the inlet. Maximum output is 100 W.
G. Battery (DC) input	For connecting a battery (optional).
H. Battery (DC) fuse	Protects the circuitry when using a battery or other DC power source.
I. Internal memory card	Card is in the drive behind the access panel. This card contains the operating system software and the memory for storing images. This card is not user serviceable.

Base Unit, Top and Bottom



Item	Description
A. Funnel	Guides the insertion tube into the storage reel.
B. Socket for handset holder	Supports the handset holder.
C. Power switch	Turns the system on and off.
D. Shoulder-strap hooks	Strap is an optional accessory.
E. Battery connection points	For holding the optional battery in place. The bracket is part of the battery assembly.
F. Lamp	High-intensity discharge (HID) arc lamp, behind access panel.

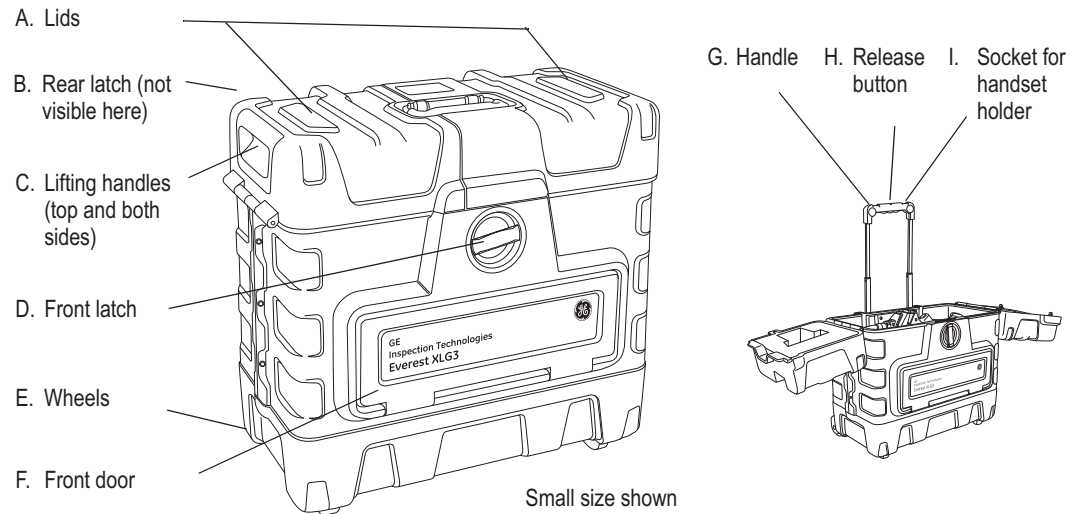
Base Unit, Back



Item	Description
A. Handset power plug	Connects the handset cable to the base unit.
B. Lock screw ring	Latch that disconnects the power plug.
C. Pocket	Mesh storage pocket.

Case

Available in two sizes, the rugged XLG3 case protects the components and accessories during storage, shipping, and operation. The system may be shipped in the storage case without additional overboxing.

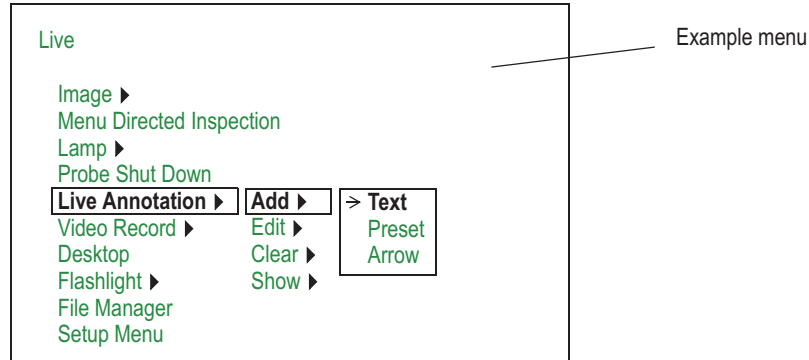


Item	Description
A. Lids	Allow access to components and accessories. Also provide ventilation to prevent overheating when operating with base unit in the case.
B. Rear latch (not visible here)	Together with the front latch, this latch releases the lids.
C. Lifting handles (top and both sides)	Three handles let you lift case whichever way is most convenient.
D. Front latch	Releases lids and front door.
E. Wheels	Let you transport case easily.
F. Front door	When operating with base unit in the case, the front door provides access to base unit's front panel. Front door must be left open to provide ventilation and prevent overheating.
G. Handle	Allows for easy transportation of system. Also supports handset holder.
H. Release button	Releases handle to allow you to extend it. Also releases handset holder from handle.
I. Socket for handset holder	Supports handset holder.

Navigating the Menus



You can navigate the menus using the control buttons on the handset or remote control.

For complete menu structure, see “Menu Trees” on page 141.



Desired Type of Navigation	Control Button
To open a main menu	
To highlight an item	Joystick
To move between a parent menu and submenu or To change the highlighted option	Joystick
To select the highlighted item	
To exit menus	or

Restoring Factory Defaults

To restore factory defaults press and hold the Save  and Record  Buttons for five seconds. Then confirm restoration of factory defaults. Performing this action restores the following options.

- Battery Icon On
- Date/Time..... On
- Logo..... On.
- Temperature Icon..... On
- Text Color..... Green
- Image Format..... JPG
- Measurement Accuracy Index ... On
- Units of Measurement..... Inches






Note Upon next restart of VideoProbe, after restoring factory defaults, select the desired language from the initial language selection screen.

Safety Information





Before using or servicing the system, you must read and understand the following safety information.

Symbols and Terms

When the following symbols and terms appear *in this manual*, they have the following meanings:

Symbol	Term	Meaning
	WARNING	DANGEROUS VOLTAGE.
	WARNING	ELECTRICAL SHOCK HAZARD — PROPER GROUNDING REQUIRED.
	WARNING	Warning statements indicate conditions or practices that could result in injury or loss of life.
	Caution	Caution statements indicate conditions or practices that could result in damage to this product or other property.
	Caution	Surfaces may be hot.

When the following symbols appear *on the product*, they have the following meanings:

Symbol	Meaning
	Chassis grounding point.
	See accompanying documentation.
	Caution: Surfaces may be hot.
	Fuse. For continued protection against fire, replace fuse only with specified type and rating.

General Warnings

The following warning statements apply to use of the system in general. Warning statements that apply specifically to particular procedures appear in the corresponding sections of the manual.



WARNING ELECTRICAL SHOCK HAZARD — PROPER GROUNDING REQUIRED. For procedures, see [“Safe Powering and Grounding”](#) on page 23.



WARNING DANGEROUS VOLTAGE. The outer panels of the base unit should never be removed. Electrical shock hazard exists due to high internal voltage. There are no user serviceable parts inside the base unit, except for the lamp and fuses, which are accessible through the bottom and side panels, respectively. Refer all service to listed service centers.



WARNING DANGEROUS VOLTAGE. Because the insertion tube is conductive, and is connected to the base unit chassis and ground lug, do not allow the system or its working tools to come in direct contact with any voltage or current source. Prevent all contact with live electrical conductors or terminals. Damage to the equipment and/or electrical shock to the operator may result.



WARNING LAMP EMITS ULTRAVIOLET, INFRARED, AND INTENSE VISIBLE LIGHT. To prevent skin or eye injury, follow these instructions:

- Avoid looking at or touching the lamp and fiber bundle output while light is on.
- Do not operate the system when the handset is disconnected from the base unit.



WARNING POSSIBLE EXPLOSION HAZARD. Do not use this system in explosive environments.



WARNING USE PROPERLY. Using of any piece of this equipment in a manner not specified by the manufacturer may impair the product's ability to protect the user from harm.

General Cautions

The following caution statements apply to use of the device in general. Caution statements that apply specifically to particular procedures appear in the corresponding sections of the manual.



Caution ALLOW ADEQUATE VENTILATION. Otherwise, the base unit might overheat. Do not cover or drape anything over the base unit. To ensure adequate airflow, provide a 3 inch (7.6 cm) distance between the base unit and any solid objects. When the base unit is installed in the case (the preferred configuration), the front door of the case must be open during operation to prevent overheating. It is recommended that you also leave the lids open.



Caution REMOVE POWER PROPERLY. To remove all power from the equipment, the disconnect device is the AC mains cord and, if equipped, the battery connector.



Caution HANDLE PROBE CAREFULLY. Keep the insertion tube away from sharp objects that might penetrate its outer sheath. Keep the whole insertion tube as straight as possible during operation; loops or bends anywhere in the tube decrease your ability to steer the probe tip. Avoid bending the insertion tube sharply; the fragile fibers contained inside may break. Always use the Home button to straighten the bending neck before withdrawing insertion tube from inspection area or putting probe away. Never pull, twist, or straighten the bending neck by hand; internal damage may result. At the first sign of damage, return the probe for repair.








Caution CERTAIN SUBSTANCES MAY DAMAGE THE PROBE. For a list of substances that are safe for the probe, see [“Chemical Compatibility”](#) on page 137.

Informations sur la sécurité





Avant l'utilisation ou l'entretien du système, vous devez lire et comprendre les informations de sécurité qui suivent.

Symboles et termes employés

Voici la signification des symboles et termes suivants employés **dans ce manuel** :

	AVERTISSEMENT	TENSION DANGEREUSE.
	AVERTISSEMENT	RISQUE DE CHOC ELECTRIQUE - RACCORDEMENT À LA TERRE OBLIGATOIRE.
	AVERTISSEMENT	Les avertissements préviennent de situations ou de pratiques risquant de provoquer des blessures, voire un danger de mort.
	Attention	Les mentions Attention préviennent de situations ou de pratiques risquant d'endommager le produit ou d'autres biens.
	Attention	Les surfaces concernées peuvent être brûlantes.

Voici la signification des symboles et termes suivants apposés **sur le produit** :

	Point de retour à la terre sur le châssis.
	Voir la documentation jointe.
	Attention: Les surfaces concernées peuvent être brûlantes.
	Fusible. Pour maintenir la protection contre les risques d'incendie, remplacer le fusible uniquement par un fusible du type et de l'ampérage spécifié.

Avertissements généraux

Les avertissements suivants s'appliquent à l'utilisation du système en général. Les avertissements qui s'appliquent spécifiquement à des procédures particulières sont indiqués dans les sections correspondantes de ce manuel.



AVERTISSEMENT RISQUE DE CHOC ELECTRIQUE - RACCORDEMENT À LA TERRE OBLIGATOIRE. Pour les procédures, veuillez consulter la rubrique “Safe Powering and Grounding” en [page 23](#).



AVERTISSEMENT TENSION DANGEREUSE. Les panneaux extérieurs de la base ne doivent jamais être enlevés. Le risque de choc électrique est dû à la présence de tension électrique élevée dans l'unité. La base ne contient aucune pièce dont l'utilisateur puisse effectuer l'entretien ; les seuls éléments concernés sont la lampe et les fusibles qui sont respectivement accessibles par le panneau inférieur et le panneau latéral. Pour les opérations d'entretien, veuillez vous adresser aux centres de service indiqués.



AVERTISSEMENT TENSION DANGEREUSE. La gaine est conductrice et reliée au châssis de la base et à la borne de retour à la terre ; ne laissez pas l'appareil ni ses outils entrer en contact direct avec une source de tension ou d'intensité électrique. Évitez tout contact avec des conducteurs ou des bornes électriques sous tension. L'équipement risquerait d'être endommagé, ou l'opérateur de subir un choc électrique.



AVERTISSEMENT LA LAMPE ÉMET DES ULTRAVIOLETS, DES INFRAROUGES ET UNE LUMIÈRE VISIBLE INTENSE. Suivez les instructions ci-dessous pour éviter une blessure cutanée ou oculaire :

- Évitez de regarder ou de toucher la lampe ou l'extrémité du faisceau de fibres optiques lorsque la lampe est allumée.
- N'utilisez pas le système lorsque le manipulateur est déconnecté de la base.



AVERTISSEMENT RISQUE D'EXPLOSION. Ne pas utiliser ce système dans un environnement à risque d'explosion.



AVERTISSEMENT UTILISER CORRECTEMENT. Si un élément de cet équipement est utilisé d'une manière non indiquée par le fabricant, l'utilisateur peut ne plus être protégé des risques de blessure.

Mentions générales Attention

Les mentions Attention qui suivent s'appliquent à l'utilisation de l'appareil en général. Les mentions Attention qui s'appliquent spécifiquement à des procédures particulières sont indiqués dans les sections correspondantes du manuel.



Attention PERMETTRE UNE VENTILATION ADÉQUATE. La base risque de surchauffer si elle n'est pas bien ventilée. Ne la recouvrez pas avec un tissu ou quoi que ce soit. Pour assurer un flux d'air adéquat, laissez un écart d'au moins 3 pouces (7,6 cm) entre la base et tout autre objet solide. Lorsque la base est installée dans son boîtier (configuration recommandée), le panneau avant de celui-ci doit être ouvert pour éviter la surchauffe de l'appareil pendant son utilisation. Nous vous recommander de laisser aussi les couvercles ouverts.



Attention METTRE HORS TENSION CORRECTEMENT. Pour mettre l'appareil totalement hors tension, débranchez le cordon d'alimentation CA et le connecteur de batterie (le cas échéant).



Attention MANIPULER LA SONDE AVEC PRÉCAUTION. Maintenez la gaine de la sonde à l'écart d'objets pointus ou tranchants qui risqueraient de traverser son fourreau. Maintenez toute la gaine aussi droite que possible pendant l'utilisation : en cas de boucle ou de courbure, il est plus difficile de piloter le bout de la sonde. Évitez de trop courber la gaine car les fibres optiques qu'elle contient sont fragiles et risquent de casser. Utilisez toujours le bouton de rangement pour redresser le collet avant de rétracter la gaine de la zone d'inspection ou de ranger la sonde. Ne manipulez jamais le collet à la main pour le tirer, le courber ou le redresser : vous risqueriez de l'endommager à l'intérieur. Envoyez la sonde en réparation au premier signe d'endommagement.



Attention CERTAINES SUBSTANCES RISQUENT D'ENDOMMAGER LA SONDE. Pour consulter la liste des substances sans danger pour la sonde, voir ["Chemical Compatibility"](#) en page 137.

2 Safe Powering and Grounding

Overview of Safe Powering and Grounding	23
Verifying AC Earth Ground Path	24
Grounding With a DC Source (Battery)	25
Special Grounding Situations	25

Overview of Safe Powering and Grounding

Safe powering and grounding practices are the responsibility of the user.

In most cases, as described in this chapter, you must connect the system to a low-impedance earth ground before using it. With that connection, any stray voltage or static electrical charge on the equipment being inspected will be conducted safely to ground and will bypass the operator.



WARNING ELECTRICAL SHOCK HAZARD — PROPER GROUNDING REQUIRED.

In most cases, safe use of this product requires the presence of a protective earth ground path at the A/C power source. Use of two-conductor extension cords or any other action that may result in the loss of this ground path are in violation of the product's safe operating requirements.



WARNING INSPECTION OF ENERGIZED EQUIPMENT. If the equipment being inspected could be energized relative to earth ground, connect both the system and the equipment being inspected to earth ground. If that is not possible, connect the system either to earth ground or to the equipment being inspected, whichever the user needs to touch. The user should maintain personal electrical isolation from the other so as to avoid becoming a path to earth ground.

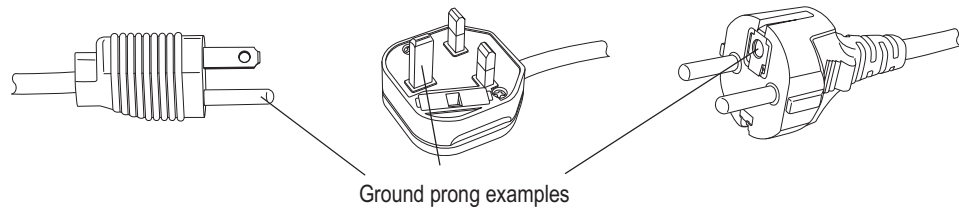
WARNING Before attempting any of the procedures in this chapter, carefully review all guidelines under “[Safety Information](#)” on page 17.

Verifying AC Earth Ground Path

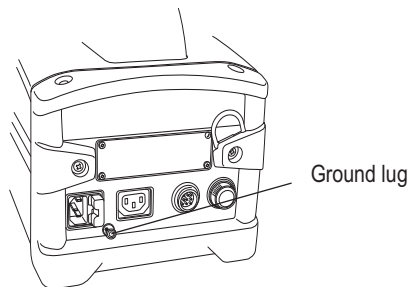
In most cases when using an AC power source, safe use of the XLG3 system requires verifying a protective earth ground path.

To Verify AC Earth Ground Path

1. Verify that the plugs on the AC cable, and any extension cord, have a ground prong.



2. Use an ohm meter to measure the resistance from the ground prong to the base unit's ground lug to be sure that the AC cable is in good condition.



3. Verify that the AC outlet has a hole for the ground prong.



WARNING Do not use a three-prong grounded plug adapter in a two-prong wall outlet. Doing so could result in a shock.

4. If a good earth ground is not available through the AC outlet, connect an external ground wire to the base unit's ground lug, then connect the wire to earth ground or to the equipment being inspected.

A ground wire (part number XLG3AGROUND) is available from GE Inspection Technologies.



WARNING CONNECTING TO A VEHICLE INVERTER. If you connect the XLG3 system to a vehicle inverter, which converts a vehicle's 12-volt DC power to 110-volt AC, even if the inverter's power outlet has a ground plug, the XLG3 system is not necessarily earth grounded, since vehicles usually have rubber tires. You must still connect the base unit's ground lug to a proper earth ground and vehicle chassis. Failure to properly ground the base unit can result in a shock.

Grounding With a DC Source (Battery)

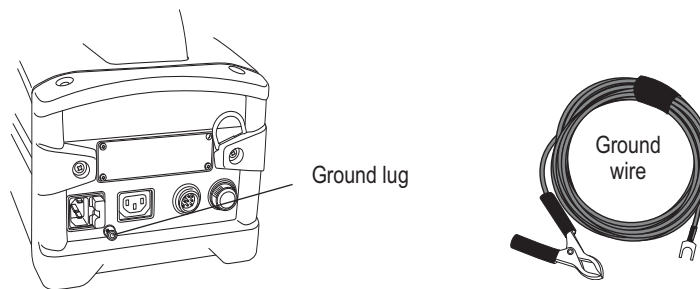
If you are using an external DC power source, such as the optional battery, while inspecting potentially energized equipment, safe use of the XLG3 system requires verifying a protective earth ground path.

To Provide DC Earth Ground Path

1. Connect an external ground wire to the base unit's ground lug.

A ground wire (part number XLG3AGROUND) is available from GE Inspection Technologies.

2. Connect the wire to earth ground or to the equipment being inspected.



Special Grounding Situations

Contact GE Inspection Technologies Technical Support for guidance prior to using the XLG3 system in any situation where the probe may come into contact with energized wires or parts.

For example, inspecting buried pipes that are electrically energized to prevent galvanic corrosion may require special grounding techniques.



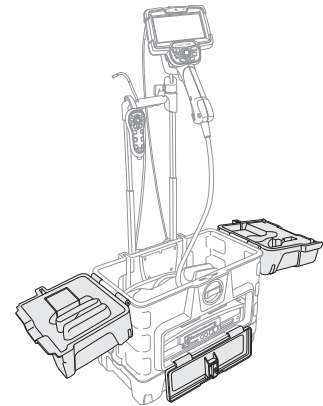
WARNING The XLG3 system and its working tools should never come in direct contact with any voltage or current source. Damage to the equipment or electrical shock to the operator may result.

3 Setting Up and Putting Away the System

Setting Up the System	27
Changing the Probe	30
Changing the Optical Tip	31
Putting the System Away	32
Communicating to a PC Through a Router or Network	34

Setting Up the System

1. Open the case's lids and front door.
Pull out and turn the front and back latches counterclockwise. Lift the center handle to open the first lid. Then open the other lid.
2. Determine whether to remove the base unit.
 - If possible, leave the base unit in the case.
 - If necessary for your application, remove the base unit.

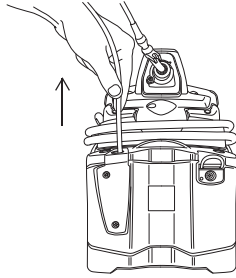


Caution If you leave the base unit in the case, leave the front door open to prevent overheating. It is recommended that you also leave the lids open.

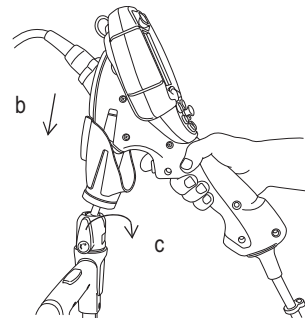
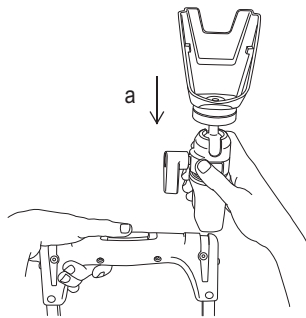
If you remove the base unit, verify that no accessories or cords are installed in any of the connectors on the front panel. Otherwise, damage might occur.

3. Verify safe powering and grounding. See [“Safe Powering and Grounding”](#) on page 23.
4. Connect to AC power, or attach battery.
 - If using AC power, plug the power cord into a grounded 110 or 220 VAC outlet.
 - If using battery for powering or backup, make sure battery is installed.
5. Turn on the power switch.
6. If this is the first time the system has been powered on, select the desired language.

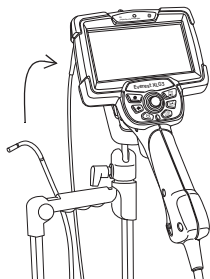
7. Remove the insertion tube.



8. Attach the handset to the handle.
 - a. Slide the handset holder into either of the sockets. (There are sockets on both sides of the handle.) The holder clicks into place.
 - b. Unwrap handset cable and remove handset. Slide handset into the holder, aligning the grooves in the back of the handset with the holder. Swivel the holder into the desired position.
 - c. Lock the swivel ball in position. (The lock holds the handset firmly in position while still letting you turn it from side to side.)

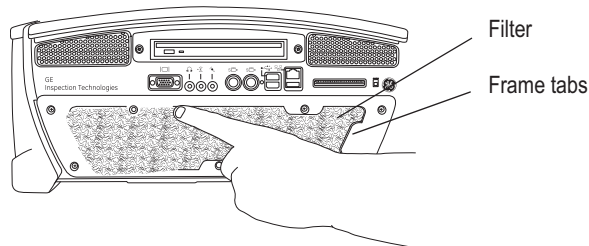


9. Install the desired optical tip. Then snap probe end into the clip near the handset. See [“Changing the Optical Tip”](#) on page 31.



10. If using the system in a dusty environment, install a dust filter.

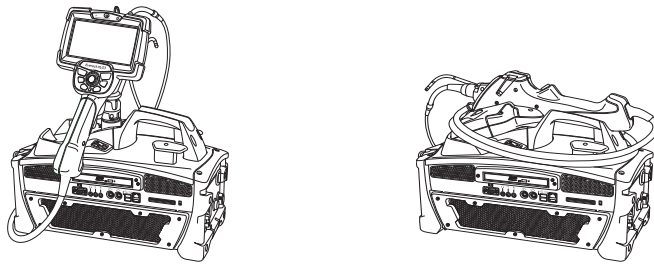
Slide the air filter between the perforated grill and the grill frame's five tabs.



11. If using any peripheral devices and accessories, attach them.

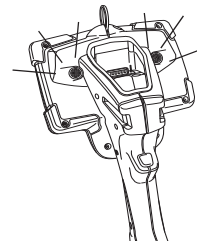
To Use the Base Unit Removed From the Case

Leave the handset face-down for carrying. Install the handset face-up for use. Slide handset holder into the socket next to the base unit's handle.




To Turn the Flashlight On and Off

While viewing a live image, press . Select **Flashlight > On** or **Off**.



To Turn the Lamp On and Off


While viewing a live image, press . Select **Lamp > On** or **Off**.

To maximize the life of the lamp, avoid frequent turning on and off.



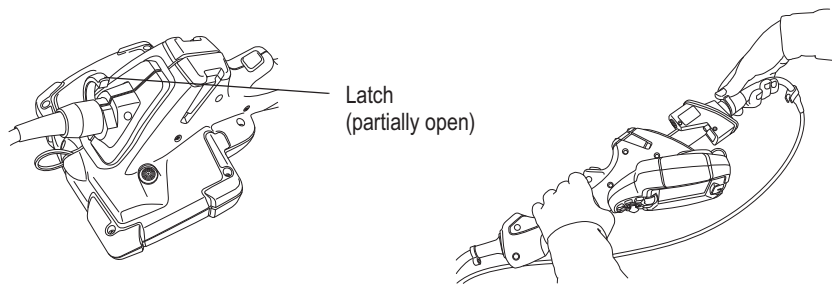
Changing the Probe

To Remove a Probe

1. Shut down the probe.
 - a. While viewing a live or frozen image, press .
 - b. Select **Probe Shut Down**.
2. Open the probe latch. The probe pops out slightly.
3. Gently slide the probe out of the handset.

To Install a Probe

1. Open the probe latch.
2. Slide the probe into the handset.
3. Close the latch.




Changing the Optical Tip

Optical tips are threaded onto the probe with a double set of threads to prevent them from falling into the inspection area. Each optical tip provides a unique depth of field, field of view, and direction of view. For a list of available tips, see [“Optical Tips”](#) on page 147.

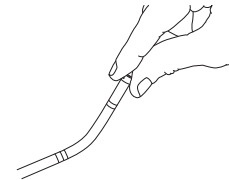


Caution Use only finger pressure to remove or attach tips. Using force — including pliers or other tools — might damage the bending neck. Take care not to cross the threads.

To Remove an Optical Tip

1. (Optional) Turn off lamp.
 - a. While viewing a live image, press .
 - b. Select **Lamp > Off**.
2. Grasp the head of the probe with one hand, and with the other gently turn the tip counterclockwise.

Turn until the tip spins freely, indicating that it has cleared the first set of threads.
3. Gently pull the tip forward (away from probe). Continue turning counterclockwise, engaging the second set of threads. Turn until you can remove it.



To Attach an Optical Tip

1. Verify that the optical tip is clean.
2. Grasp the head of the probe with one hand, and with the other gently turn the tip clockwise.

Turn until it spins freely, indicating that it has cleared the first set of threads.
3. Gently push the tip in. Turn clockwise again, engaging the second set of threads.

Turn until finger tight. Do not overtighten. Pull on the tip gently to verify that it is securely attached. If the second set of threads does not engage, turn the tip slightly in a counterclockwise direction to allow the threads to connect.

Note Measurement tips must be tightened firmly to ensure accuracy.

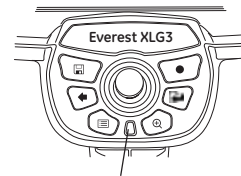
Related Information

- [“To Inspect and Clean an Optical Tip”](#) on page 115
- [“Optical Tips”](#) on page 147

Putting the System Away

To Put the System Away

1. Press and hold the button just below the joystick. The bending neck straightens.
2. If any storage devices are in place, use the Eject Hardware menu command and then remove them.



Hold this button.



Home



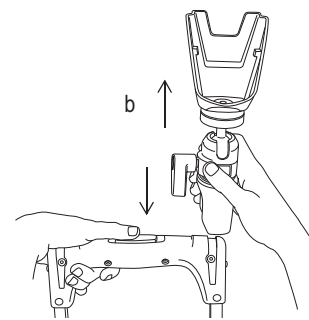
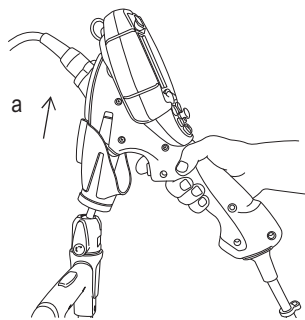
Caution Before removing storage devices, you must use the Eject Hardware menu command. For details, see [“To Eject a Storage Device Other than DVD”](#) on page 74.

3. Turn off the power switch, and disconnect power cord from the power source.
4. Detach any peripheral devices or accessories.
5. Remove the optical tip, and install the head guard.

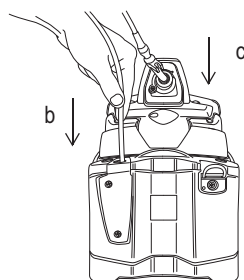


Caution The head guard prevents damage to the tip attachment mechanism. Keep the head guard on whenever no optical tip is in place.

6. Remove the handset and its holder.
 - a. Pull up on the handset, slightly twisting in either direction until it comes free.
 - b. Push the release button, and pull up on the holder.

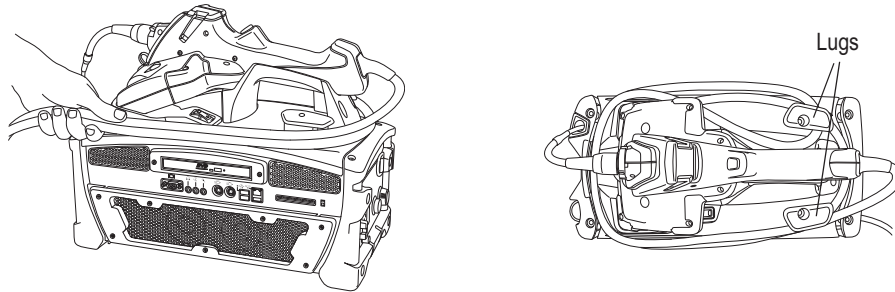


7. Store the insertion tube in the base unit's internal storage reel.
 - a. Straighten any loops or twists in the insertion tube.
 - b. Feed the insertion tube as far as it goes into the funnel.
 - c. Place the handset face-down in the base unit's handle.



8. Wrap handset cable around the top of the base unit.

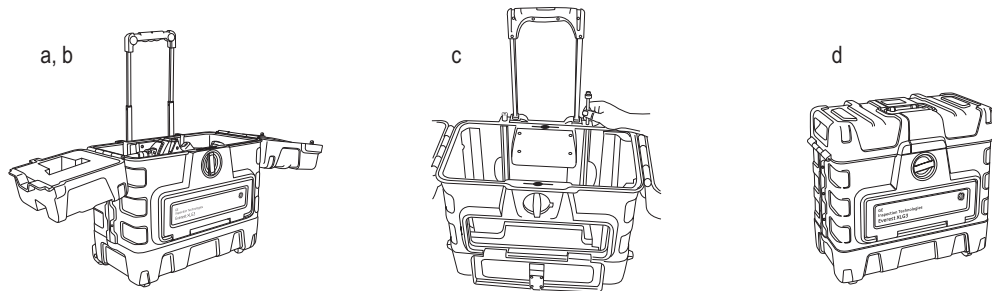
Holding the loop in your hand, wrap the cable clockwise under the first lug. Tuck the cable under the insertion tube. Hook it around the other lug.



9. Pack the system into the case.
 - a. Verify that no accessories or cords are installed in any of the connectors on the front panel.
 - b. Pack components securely into case so that no parts will be pinched in the lids.
 - c. If you have 6-inch or 12-inch rigidizers, insert them into the holes on the back of the case. The 6-inch rigidizer rests in the groove. The 12-inch rigidizer sticks out at the bottom end.
 - d. Close the lids.



Caution If you do not pack the system carefully, as described here, damage might occur.




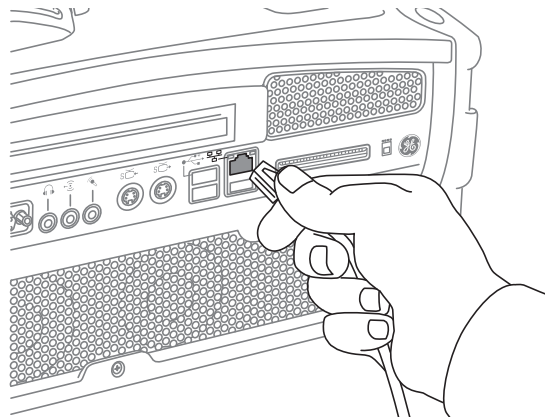
Communicating to a PC Through a Router or Network

PC and network connectivity — wired or wireless — are part of the optional network package. (See “[About the Network Package](#)” on page 5.)

If the XLG3 system is connected to a PC or network, you can send images and videos to other computers for review, further manipulation, or remeasuring. You can also send images from other computers to the XLG3 system.

To Connect the XLG3 System to a PC Through a Router or Network Via an Ethernet Cable

1. At the base unit, plug an Ethernet cable into the Ethernet connector .



2. Plug Ethernet cable into a network port.

The XLG3 Ethernet connector's LEDs light up to indicate that the connection is established.

3. **Connecting the XLG3 to a PC:**



If a local area network (LAN) port is not available, connect the XLG3 to the PC by placing an Ethernet router between them. The router will generate an IP address as described on page 45.

4. No additional software is needed to simply share files with a PC or network via a direct Ethernet connection, using Microsoft™ Internet Explorer.
5. PC Based Re-Measurement iView - This application lets you manage and measure images that were captured by the XLG3 system. It also lets you create reports from those images. To obtain iVIEW PC, contact GE Inspection Technologies.

No software is needed to simply share files with a PC or network via a direct Ethernet connection.

To Connect the XLG3 System to a Wireless Network

The instructions that follow include both “open” (non-encryption) and WEP and WPA encryption.

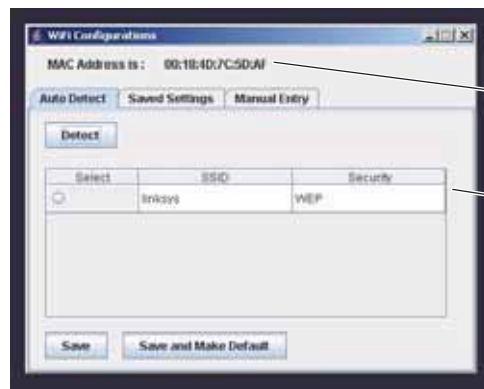
1. Press . Select **Setup Menu > Communications > IP Address > Automatic**.
2. A checkmark appears next to **Automatic**.
3. Press . Select **Setup Menu > Communications > Wireless Configuration**.

The **WiFi Configurations** window opens.

4. Select **Detect**. Please be patient; this may take several minutes.

If the system detects any network access points, they appear now, listed under the **Auto Detect** tab

If the system is connected to a network using both an Ethernet connection and a wireless connection, the system will use the Ethernet connection by default.



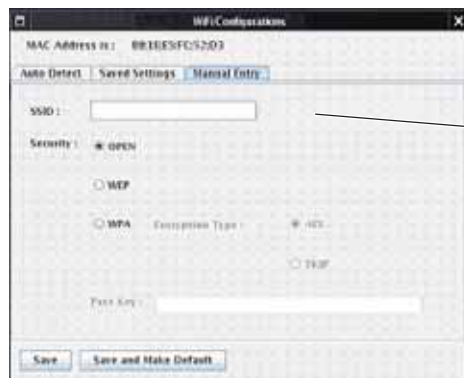
The MAC address is the wireless card's unique identifier.

Any detected access points appear here.

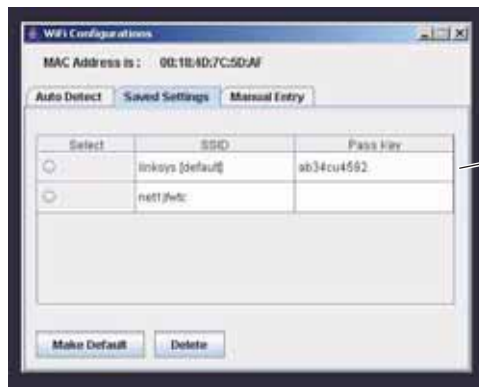
Note: The XLG3 supports both wireless B & G.

5. Select or enter a network access point.

- If at least one wireless network name (SSID) - access point is listed under the **Auto Detect** tab (shown previously), select the desired access point. Select **Save and Make Default**.
- If no access points are listed, see **Manual Entry** below.
- Under **SSID**, enter the name of the local access point. If a pass key is required for security, enter the pass key (from your network administrator.) Select **Save and Make Default**.
- If you want to see or manage the access points that have been saved, click the **Saved Settings** tab.



You can enter access points manually under the **Manual Entry** tab.



Up to five access points may be listed under the **Saved Settings** tab. If five access points are already saved and you want to use a different one, delete one from this list.

Manual Entry - Wireless Access Point

The Manual Entry tab is used to enter network information that is either for “hidden “ networks (non-broadcast of wireless name (SSID)), or to enter networks that are not presently available.

1. To create a manual entry, select the **Manual Entry** tab, as shown below.
2. Under SSID, enter the name of the local access point (SSID). If a pass key is required for security, select your appropriate security format (WEP or WPA). Select **None** when no security encryption is used.
3. Selecting WPA encryption will require you to define encryption type as **AES** or **TKIP**. Contact your local network administrator to define this information.
4. When WEP or WPA are selected, the appropriate entry field will be enabled. Next, select **Save** or **Save and Make Default**.
5. Return to the **Setup Menu > Communications**, select **Automatic**. A check mark will appear next to Automatic.
6. Exit out of the Communications Menu by selecting the **Back** button. Wait approximately 20 seconds and then return to the **Setup Menu > Communications** and an IP address should now be present.

For FireFox browser access, see *Using the Desktop (page 78)*.

4 Setting Up the Software

Reviewing Settings for Audio	39
Reviewing Settings for Image Format and Quality	40
Reviewing the Setting for Video Quality	41
Reviewing Settings for Text Color	42
Reviewing Settings for a Logo	42
Reviewing Settings for Measurement	43
Reviewing Settings for the System	44
Reviewing Settings for Communications	45

Reviewing Settings for Audio

Audio settings affect only audio output, not input. If you want to turn off audio input for video recording, you can do so before you start recording.

To Review Settings for Audio


1. Press .
2. Select **Setup Menu > Audio**.
3. Select the desired item:

Item	Description
Volume	Adjust the volume to the internal speaker and headphone output. This control does not affect line-level output.
Mic	On, muted or disabled. When on, live audio is sent from the microphone to the line-level output, and audio is saved during video recording. When muted, live audio is not recorded, but an audio track is created on MPEG2 recordings. When disabled, live audio is not sent to any outputs, and no audio track is created on MPEG2 recordings. The system still does save audio comments that you choose to record for still images.

Reviewing Settings for Image Format and Quality

If you want to choose the format or quality for a particular image you want to capture, you must change the setting before capturing that image.

To Change Settings for Image Format and Quality

1. Press .
2. Select **Setup Menu > Still Save**.
3. Select the desired settings:
 - **Save Format — JPEG or Bitmap**
 - **JPEG Quality — High or Low**

Stereo measurement JPEGs are always saved at high quality, even if this setting is **Low**.

Decision Factors for Image Format and Quality

When changing format and quality settings, consider these factors:

- which format is required or preferred
- (for JPEGs only) whether high or low quality is more appropriate
- how much storage space is available
- how many files (images and videos) need to be stored

This table may help you determine the best settings for your situation.


File Format and Quality	Typical File Size ^a	Storage Capacities (Approx. Number of Images) ^b	
		2.7 GB Internal Drive ^c	512 MB Removable Storage Device
BMP (Stereo/Shadow)	900 KB	~3000	568
JPEG High (Stereo/Shadow)	200 KB	~13,500	2560
JPEG Low (Stereo/Shadow)	60 KB	~50,000	8533
BMP (Phase)	3.4 MB	~800	150
JPEG High (Phase)	2.3 MB	~1200	223
JPEG Low (Phase)	2.3 MB	~1200	223
BMP (Point Cloud)	1.6 MB	~1700	320
JPEG High (Point Cloud)	500 KB	~5400	1024
JPEG Low (Point Cloud)	400 KB	~6700	1280

- a. File size varies by image content. These sizes are based on typical NTSC images; PAL images are 10% larger.
- b. Audio (WAV) files consume about 120 KB for every 15 seconds of audio. Image storage capacity must be reduced by the amount of audio recorded.
- c. To learn how to check the available memory on your internal drive, see [“Reviewing Settings for the System”](#) on page 44.

Reviewing the Setting for Video Quality

If you want to choose the video quality, you must change the setting before you record. All videos are FMV (full-motion video) MPEG2 files.

To Change the Setting for Video Quality

1. Press .
2. Select **Video Record > Recording Options > MPEG Quality**.
3. Select the desired setting:
 - **MPEG2 High**
 - **MPEG2 Low**

Decision Factors for Video Quality

When changing the video quality setting, consider these factors:

- which quality level is required or preferred
- how much storage space is available
- how many files (images and videos) need to be stored

This table may help you determine the best settings for your situation.

MPEG Quality	Typical File Size ^a	Storage Capacities (Approx. Number of Seconds) ^b		
		2.7 GB Internal Drive ^c	512 MB Removable Storage Device	4.3 GB DVD
MPEG2 High	1 MB/s	~42 min	~8 min	~1 hr, 10 min
MPEG2 Low	0.5 MB/s	~1 hr, 24 min	~17 min	~2 hr, 20 min

- a. File size varies by image content. These sizes are based on typical NTSC images; PAL images are 10% larger.
- b. Audio files, which consume approx. 300 KB per second of video, are saved with video files.
- c. To learn how to check the available memory on your internal drive, see ["Reviewing Settings for the System"](#) on page 44. The available memory also appears on the Recording Options screen; see ["Recording Live Video"](#) on page 69.

Reviewing Settings for Text Color

You can change the color of text and other elements that are displayed over the images (for example, the dashed line that you center over the shadow when taking shadow measurements). The most legible color will vary with the coloring and brightness of the image.

To Change the Text Color

1. Press .
2. Select **Setup Menu > Graphics > Text Color**.
3. Select a color:
 - **White**
 - **Black**
 - **Green**


Reviewing Settings for a Logo

You can add a logo to the screen. You can use any graphics program to create the logo, as long as you save it with these attributes:

- Microsoft Windows-compatible
- 24-bit color
- 200 pixels x 200 pixels maximum
- file name LOGO.BMP
- transparent background color (if desired): red 128, green 128, blue 0

The system can store only one logo file.


To Work With a Logo

1. Insert the removable storage device that contains the logo file.
2. Press .
3. Select **Setup Menu > Graphics > Logo**.
4. Select the desired item:
 - **On** — Turns the logo on.
 - **Off** — Turns the logo off.
 - **Load** — Automatically installs the logo file from your storage device to the internal drive.

Reviewing Settings for Measurement

For XLG3 systems equipped with measurement capability, these settings determine system behavior when you are taking measurements. For details, see [“Measuring Features and Defects”](#) on page 87.

To Review Settings for Measurement

1. Press .
2. Select **Setup Menu > Measure**.
3. Change any desired settings.

Item	Description
Phase	The Cal Info option displays calibration data for the selected phase tip. All other options are for factory-authorized personnel only.
Stereo	The Cal Info option displays calibration data for the selected stereo tip. All other options are for factory-authorized personnel only.
Shadow	The Cal Info option displays calibration data for the selected shadow tip. All other options are for factory-authorized personnel only.
Units	Inches, mm. Determines which units are displayed.
Set Min Index	Accuracy index's minimum value. If the index drops below this value, it flashes.
Index Display	On, off. Determines whether the accuracy index is displayed.
User Prompts	On, off. Determines whether user prompts are displayed in measurement mode. Only trained professionals should turn these prompts off.

Reviewing Settings for the System

1. Press .
2. Select **Setup Menu > System**.
3. Select the desired item:

Item	Choices	Description
System Info		System information appears: <ul style="list-style-type: none"> • Total memory capacity • Remaining memory • Software revision levels • Language
Language	Select	Choose from a list of languages.
	Load	System automatically installs a language file from an external storage device, if any. You must then select the language.
Time/Date	Show	On, off.
	Set	Change the time or date. Time is always in 24-hour format. Date is always in day/month/year format.
Steering	Tip Map	On, off. The tip map is a grid that indicates probe-tip position.
	Zoom Mode	Steer Only — In this mode, when you move the joystick in a zoomed live view, the probe tip articulates. The image changes as the camera moves. Pan Only — In this mode, when you move the joystick in a zoomed live view, the probe tip does not articulate. The image changes as the system electronically pans the camera's full view.
MDI	Load, Unload	Load or unload an existing inspection on the XLG3.
	Annotate -- On, Off	If off, the menu-directed inspection on-screen prompts are not saved in the image.
Update Software		For use with the XLG3 Update Software CD-ROM or thumbdrive.
Feature Update		For use with the XLG3 Feature Installation CD-ROM or thumbdrive.
Video Output Format	NTSC	Standard in US and elsewhere.
	PAL	Standard in Europe and elsewhere.
LCD Display	Full	The image fills the screen. The top and bottom are cropped. There are no black bands at the sides.
	4x3	The complete image that the camera "sees" is displayed. The top and bottom are not cropped. There are bands of black at the sides.
	Unscaled	The image nearly fills the screen. The top and bottom are slightly cropped; there are narrow bands of black at the sides. Unscaled is automatically selected when measuring for most accurate placement of cursors.


Reviewing Settings for Communications

Communications settings are part of the optional network package. (See [“About the Network Package”](#) on page 5.)

The communications settings apply to XLG3 systems connected to a PC or network.

Note The XLG3 system is designed to operate in a protected computing environment behind a firewall.

To Review Settings for Communications

1. Press .
2. Select **Setup Menu > Communications**.
3. Change any desired settings.

Item	Choices	Description
Unit Name		Displays the system's serial number.
IP Address	None, Automatic, or Advanced	Displays the system's IP address and lets you select a setting. Select the setting recommended by your network administrator. Note: When establishing communications with a PC, the setting must be Automatic.
Remote File Access	Disallow	Prevents remote users from accessing files stored on the XLG3 system.
	Allow Read	Lets remote users read and copy files stored on the XLG3 system.
	Allow Read/Write	Lets remote users read and copy files stored on the XLG3 system and transfer files to the system.
Relink Now		Establishes communications between the network and a newly connected XLG3 system that was already turned on when you connected it.
Wireless Configuration		Displays wireless settings. Lets you select a wireless access point.
Video streaming	On/off	Lets remote users view live video. When video streaming is on, video cannot be recorded to the DVD drive.

5 Capturing Images and Videos

Process Overview	47
Steering the Probe	49
Freezing an Image	50
Working With a Recalled Image	51
Working With a Split Screen	52
Adjusting the Brightness	53
Reducing “Noise” in Dark Images	54
Correcting Wide-Angle Distortion	56
Lengthening Exposure Time	57
Enhancing Contrast	58
Zooming	58
Inverting an Image	59
Annotating With Text or Arrows	60
Saving an Image	65
Working With Videos	67

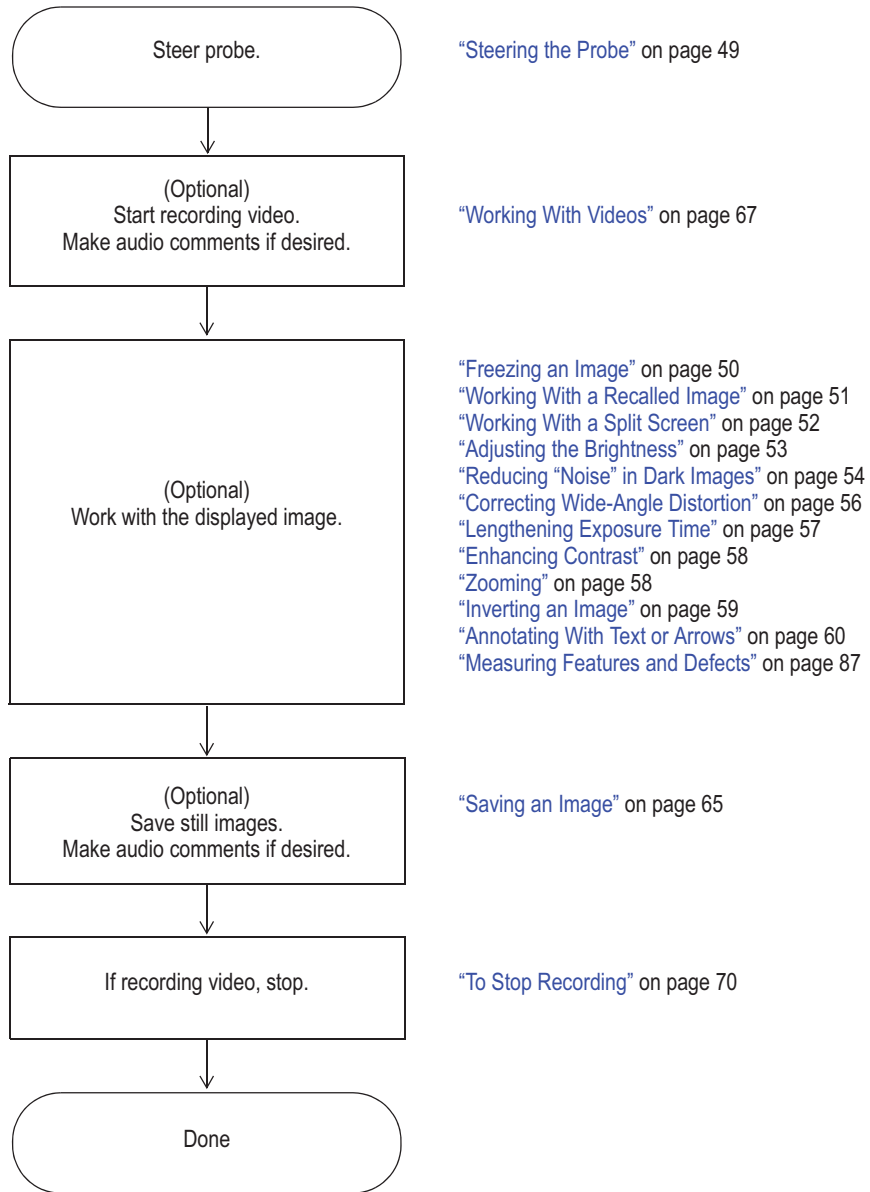
Process Overview

The process of capturing images and recording videos may be simple or complex, depending on what you want to accomplish.

You can record audio comments for still images or videos using the built-in microphone in the handset, an external microphone, or a headset microphone.

For an illustration, see “[Process Diagram: Capturing Images and Videos](#)” on page 48.

Process Diagram: Capturing Images and Videos



Steering the Probe

Guiding the Insertion Tube Into the Inspection Area

With the desired optical tip installed, guide the insertion tube into the inspection area. Use your hands to push the tube until it reaches an area you want to inspect.

Twist the insertion tube gently to bring the desired scene into view.

Accessories are available to make it easier to maneuver the tube:

- Rigidizers, long thin pipes that keep the tube straight as you insert it, are available in different lengths.
- A gripper is a cylindrical handle that slides over the insertion tube to make it easier to control. Grippers are threaded to connect to rigidizers and to access port couplers.



Rigidizer

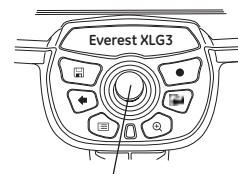
Gripper

Aiming the Camera

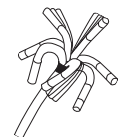
A live image is the image that the camera “sees” in real time. When you are viewing a live image, you can aim the camera by controlling the bending neck in various ways.

To Articulate the Bending Neck

While viewing a live image, move the joystick toward the feature you want to see. The bending neck articulates so that the probe tip moves in that same direction.



Move the joystick.



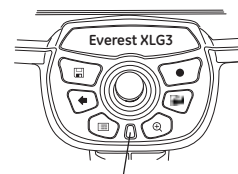
360° All-Way® articulation

To Hold the Bending Neck in Place (Steer-and-Stay Mode)

Press the button just below the joystick. Press quickly; do not hold. The letters SS appear, indicating Steer-and-Stay™ mode.

In this mode, the bending neck holds its position even when you let go of the joystick. If you move the joystick while in Steer-and-Stay mode, the bending neck articulates slowly. When you stop moving the joystick, the bending neck stays in the new position.

To exit Steer-and-Stay mode, press the button again. The letters SS disappear.



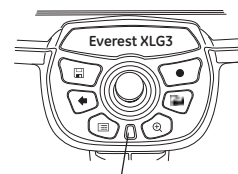
Press this button.



Steer-and-Stay

To Straighten the Bending Neck (HOME)

Press and hold the button just below the joystick. The bending neck straightens for safe withdrawal and storage of the insertion tube.



Hold this button.




Home

Freezing an Image

Freezing an image captures it temporarily for review or adjustment.



When you move the joystick in a frozen view, the probe tip does not articulate. If you zoom in on a frozen image and then move the joystick, the image changes as the system electronically pans the camera's full view.

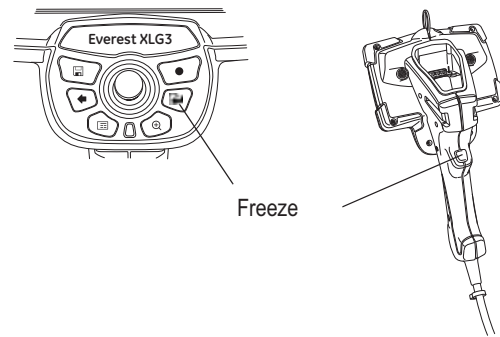
To Freeze an Image

Press  or the trigger.

The image freezes. The letters *FF* (for freeze frame) appear.


To Unfreeze an Image

Press , or the trigger, or .






Working With a Recalled Image

To Work With a Recalled Image

1. Recall the desired image.
 - a. Press .
 - b. Select **File Manager** > **Recall** > *drive or device*.
 - c. Select a file. It opens.

Note When viewing a recalled image, you can cycle through the other images stored in the same folder by moving the joystick.

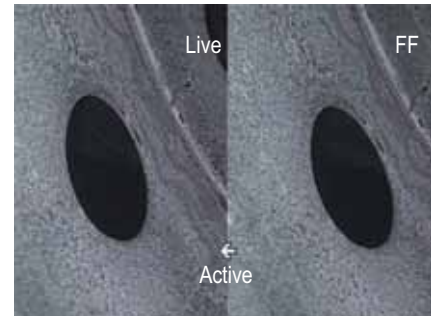
2. Determine your next action.
 - To rename the image, press . Select **Rename Image**. Enter a new file name. The new name overwrites the old.
 - To play recorded audio comments, if any, press . Select **Play Audio**.
 - To record comments, press . Select **Record (or Re-record) Audio**. Speak into the microphone.

For information on general tasks — adjusting brightness, zooming, annotating, saving, etc. — see “[Process Diagram: Capturing Images and Videos](#)” on page 48.

Working With a Split Screen

A split screen displays two images side-by-side in any combination of live, frozen, or recalled. Only one side is active at a time, as indicated by an arrow.

Still images in half-screen view are cropped horizontally. You can use the joystick to pan side-to-side within these images.



To Work With a Split Screen

1. Split the screen.

Press . Select **Image > Split Screen**.

On the left, a live image appears. On the right, the previous full-screen image appears at half-screen size. If it was previously live, it is now frozen.

2. (Optional) Change active sides, or temporarily view one image at full size.
 - a. Press .
 - b. Select **Split Options**.
 - c. Select any items:

Item	Description
Left/Right > Active	The selected side becomes active.
Left/Right > Full Screen	The selected side's image fills the screen.
	When finished viewing, press . Select View other image or Back to split screen

For information on general tasks — adjusting brightness, zooming, annotating, saving, etc. — see “[Process Diagram: Capturing Images and Videos](#)” on page 48.

3. When ready, exit the split screen.
 - To return immediately to a live image, press .
 - To select one of the displayed images to view upon exiting, press . Select **Split Options > Left/Right > Close**.


Adjusting the Brightness

You can adjust the brightness of live, frozen, and recalled images as well as recorded video.

When viewing live images, adjusting the brightness means controlling exposure time and camera gain. When viewing still images or recorded video, adjusting the brightness means controlling digital gain.

The brightness saved will be the brightness recalled.

To Adjust the Brightness

1. Press .
2. Select **Image > Brightness**.
3. Adjust.

Reducing “Noise” in Dark Images

Adaptive Noise Reduction (ANR) is part of the image processing package. (See [“About the Image Processing Package”](#) on page 4.)

When the probe is in a dark area, the live image is often noisy, or grainy (“crawling pixels”). You can improve such images by turning on ANR in either of two modes:

- ANR normal — Reduces noise without any brightening.
- ANR enhanced — Reduces noise and brightens dark areas. (Does not brighten areas that are already bright.)

Note ANR annotation is saved with image.



ANR off



ANR normal
(Noise is reduced without brightening.)



ANR off



ANR enhanced
(Noise is reduced and dark areas are brightened.)

To Turn On ANR

1. While viewing a live image, press .
2. Select **Image > Adaptive Noise Reduction > Normal** or **Enhanced**.

Note When ready to capture an image, keep the probe head as still as possible. When the probe head is moving, noise increases.

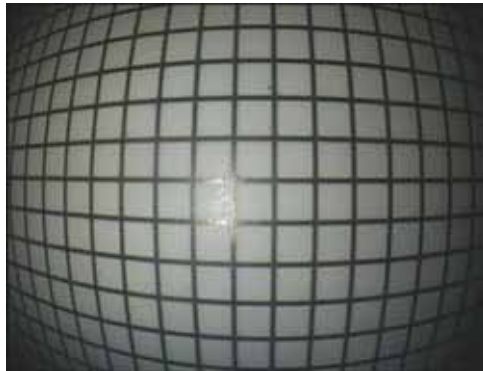
To Turn Off ANR

1. Press .
2. Select **Image > Adaptive Noise Reduction > Off**.

Correcting Wide-Angle Distortion

Distortion correction is part of the image processing package. (See “[About the Image Processing Package](#)” on page 4.)

When you use an optical tip with a 120° field of view, the image edges are distorted. You can improve such images by turning on distortion correction.




120° optical tip,
distortion correction off



120° optical tip,
distortion correction on

Note 120 Deg annotation on image is saved with the image.

To Turn On Distortion Correction

1. While viewing a live image with a 120° optical tip installed, press .
2. Select **Image > Distortion Correction > 120 Deg**.

Note If you enter a measurement mode, a corrected image reverts to its uncorrected state for accuracy.


To Turn Off Distortion Correction

1. Press .
2. Select **Image > Distortion Correction > Off**.

Lengthening Exposure Time


One way to brighten live images is to lengthen the camera's exposure time. The XLG3 system can vary the exposure time from 1/10,000 second to 12 seconds. The longer the exposure, the greater the risk of blurring the image. Keep the probe tip as still as possible when capturing an image with a long exposure.

To Lengthen Exposure Time

1. While viewing a live image, press .
2. Select **Image > Long Exposure**.
3. Select the type of long exposure you want.
 - **Auto** — The system sets the exposure time.
 - **Manual** — You set the exposure time. Move the joystick until the image is as light as you want it.

Lg Exp appears.

To Turn Off Long Exposure

Press .

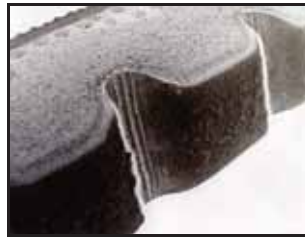
Enhancing Contrast

When there is not enough light or contrast to see important features or defects — for example, when you need to position cursors accurately for measurements — “Inverse +” may help. This feature reverses the brightness like a photographic negative. It enhances the image contrast, making subtle details more visible.

You can enable “Inverse +” for any live, frozen, or recalled image.



“Inverse +” off




“Inverse +” on

To Turn “Inverse +” On

1. Press .
2. Select **Image > Inverse + > On**.

To Turn “Inverse +” Off

Press .

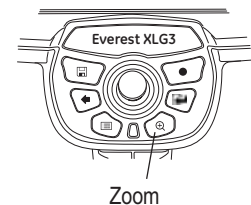
Zooming

You can zoom in and out for all types of images: live, frozen, and recalled.

Zooming is digital, so pixelation increases as you zoom in.

The system cycles through the zoom levels in increments up to 3.0x. When an image is zoomed, its zoom level (for example ZM 2.6) appears on the screen.

To learn about the two zoom modes, which determine what happens when you move the joystick in a zoomed live view, see [“Reviewing Settings for the System”](#) on page 44.



To Zoom

Press .

For larger increments, press  repeatedly. For smaller increments, hold .

To Unzoom

Press .

Inverting an Image

The Invert function flips an image horizontally. You can invert a live, frozen, or recalled image.

You may want to invert images when using a side-view optical tip, since these tips contain a prism that inverts images, causing text to appear backwards.



Invert off




Invert on

To Invert an Image

1. Press .
2. Select **Image > Invert > On**.

To Uninvert an Image

Press .

Annotating With Text or Arrows


Annotating an XLG3 image means adding text or arrows to point out areas of interest: cracks, defects, etc. You can annotate live, frozen, and recalled images.

You can create two types of annotation:

- **Live annotation** is general information — relevant to the entire inspection or a significant portion of it — to be displayed constantly except when hidden. You can show or hide live annotation any time. You would use live annotation, for example, while recording video. To add or clear live annotation, you must be viewing a live image. When you're viewing a still image, you can choose whether to show or hide the live annotation.
- **Still annotation** is information that is specific to a particular image. To display or add still annotation, you must be viewing a still image (frozen or recalled). When you return to a live image, still annotation is cleared.


If you anticipate using certain text over and over, you may want to create one or more *presets* — ready-to-use annotations. You can create multiple presets for use in either live or still annotations. Maximum = 100 presets, 5 lines per preset, 28 characters per line.

To Annotate a Live Image

1. Press .
2. Select **Live Annotation**.
3. Select the desired item:


Item	Choices	Description
Text	Add	Create text for use in a live annotation.
	Edit	Edit existing live text annotations.
	Delete	Deletes all live annotation text from the screen and from memory.
Arrow	Add	Create an arrow for use in a live annotation.
	Edit	Edit existing live arrow annotations.
	Delete	Deletes all live annotation arrows from the screen and from memory.
Preset	Create	Add a new text annotation to the preset manager.
	Recall	Select an existing text annotation from the preset manager to place.
	Edit	Edit an existing text annotation from the preset manager.
	Delete	Delete an existing text annotation from the preset manager.
	Import	Load a .txt file containing presets (see page 61 for details).
	Export	Export a .txt file containing presets.
Show	On, Off	Turns live annotation (text and arrows) on or off.

To Annotate a Still Image

1. Press .
2. Determine whether to display or hide live annotation, if any.
Select **Live Annotation > Show > On or Off**.
3. Select **Still Annotation**.
4. Select the desired item.

Item	Choices	Description
Text	Add	Create text for use in a still annotation.
	Edit	Edit existing still text annotations.
	Delete	Deletes all still annotation text from the screen and from memory.
Arrow	Add	Create an arrow for use in a still annotation.
	Edit	Edit existing still arrow annotations.
	Delete	Deletes all still annotation arrows from the screen and from memory.
Preset	Create	Add a new text annotation to the preset manager.
	Recall	Select an existing text annotation from the preset manager to place.
	Edit	Edit an existing text annotation from the preset manager.
	Delete	Delete an existing text annotation from the preset manager.
	Import	Load a .txt file containing presets (see page 61 for details).
	Export	Export a .txt file containing presets.
Show	On, Off	Turns still annotation (text and arrows) on or off.

Note In addition to annotating with text and arrows, you can also add audio comments to a still image in either of two ways:

- Immediately after saving an image, you can select **Record Audio**.
- If viewing a recalled image, you can press , and then select **Audio > Record Audio**.

Note Changing the display size will change annotations location and may cause annotation to be cut off.

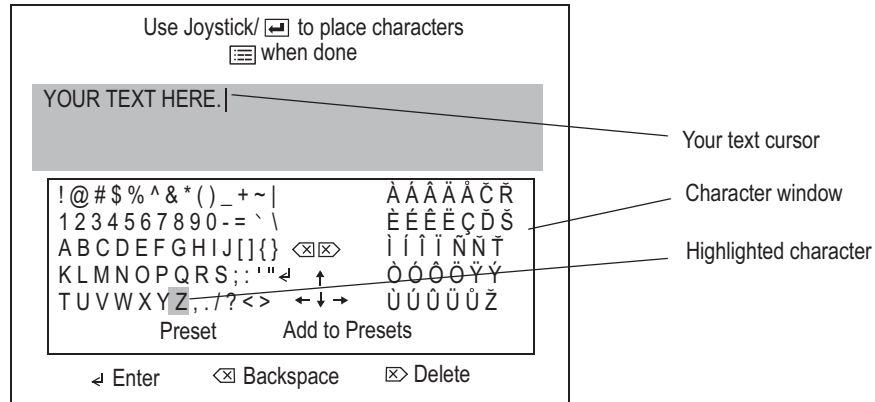
Note

- Preset .txt files may contain presets less than 28 characters each.
- Up to 100 presets may be loaded.

To Use the Text-Entry Screen

You use the text-entry screen when creating an annotation or preset.

Note For faster text entry, you can use a USB keyboard.



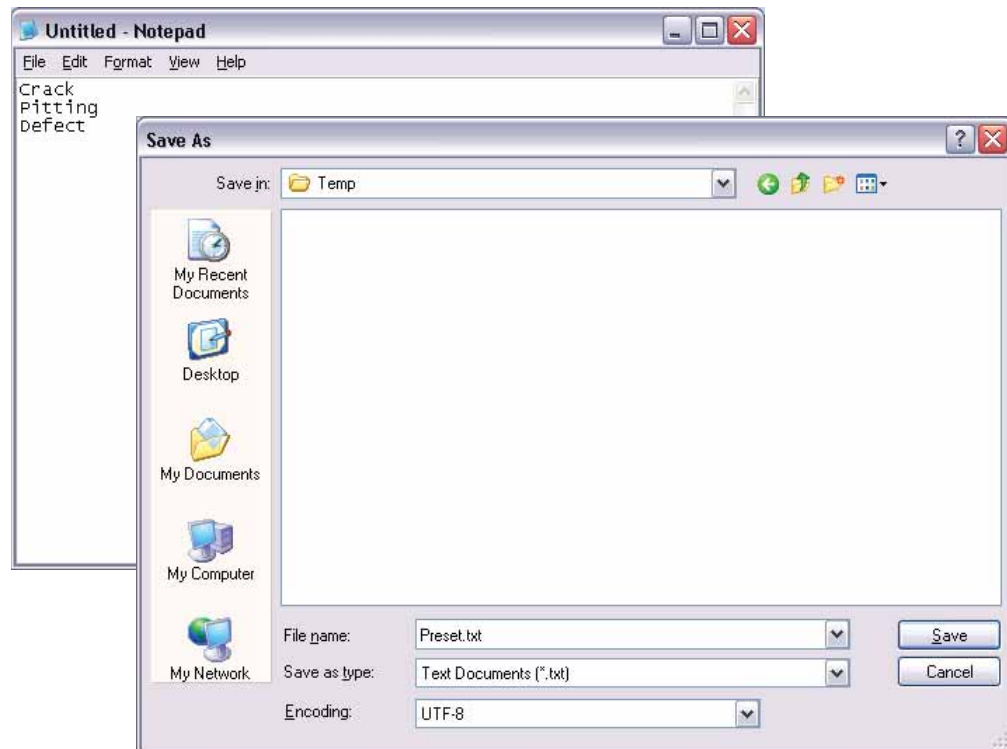
1. If necessary, position your text cursor.
 - a. Move the joystick to highlight an arrow key $\leftarrow \uparrow \rightarrow$ in the character window.
 - b. Press \leftarrow on the handset. Your text cursor moves in the selected direction.
 - c. Repeat until your text cursor is in the desired position
2. Move the joystick to highlight the desired item in the character window.
 - If you want to add a character, highlight that character. For a space, highlight any blank.
 - If you want to start a new line, highlight \leftarrow .
 - If you want to delete a character, highlight \leftarrow or \rightarrow .
3. Press \leftarrow on the handset to activate the highlighted item.
4. Repeat from Step 1 until you are finished creating your annotation.
5. Press $\left[\text{list icon}\right]$. The text-entry screen disappears. Your text is displayed.
6. Determine what to do next.
 - If you have just created an annotation, move it to the desired location.
 - If you have just created a preset, follow the on-screen instructions.

To Load a Preset File


To load a file containing multiple presets onto the XLG3 VideoProbe, a file may be created on a PC. This file must conform to the following:

- Line-delimited (each preset must be on a separate line)
- File Type - .txt
- Encoding - UTF-8
- Recommended Program - Microsoft Notepad

At the time of saving the document, select .txt as the File Type and UTF-8 as the Encoding (as shown below).



Loading the File

1. Save the Preset.txt file onto external media (CF Card, USB ThumbDrive, etc.).
2. Insert the external media in your XLG3 VideoProbe.
3. Press .
4. Select **Live Annotation**.
5. Select **Preset > Load**.
6. Locate the file that you have created.

Annotating with Alternate Input Methods

The XLG3 VideoProbe supports text entry with advanced input methods for Simplified Chinese (Pinyin) and Japanese (Hiragana to Katakana/Kanji). To utilize these input methods the user must have an external keyboard connected to their VideoProbe. These input methods default as active when either Chinese or Japanese are selected as the system language. To return to an on-screen keyboard that doesn't utilize an input method, toggle the button that reads "Input Method -/O".

Chinese

The XLG3 VideoProbe supports the Pinyin text entry method. For each word or phrase that you wish to enter, follow the steps below:

1. Using the external keyboard, type the Pinyin representation of the character to be entered.
2. Use the numbers on the external keyboard to select the desired character from the candidate list.
3. Press the enter key on the external keyboard to confirm the selection.

Japanese

The XLG3 VideoProbe supports a text entry method that converts Hiragana to Katakana and Kanji characters. For each word or phrase that you wish to enter, follow the steps below:

1. Using the external keyboard, type the Hiragana that make up the word being entered.
2. When all of the Hiragana that make up the word are entered, press the space bar on the external keyboard to get a candidate list of Katakana and Kanji characters.
3. Use the numbers on the external keyboard to select the desired word or phrase from the candidate list.
4. Press the enter key on the external keyboard to confirm the selection.

- Note**
- If the desired word or phrase is not shown in the candidate list, press Page Up/Page Down on the external keyboard to cycle through more candidates.
 - A maximum of 6 Hiragana may be entered for each word or phrase for Japanese text entry

Saving an Image

Saving an image is like taking a snapshot. Most screen elements — date, time, zoom level, annotations, measurements, etc. — become part of the saved image. What you see is what you save.

You can save live, frozen, split-screen, or recalled images.



There are two save modes:

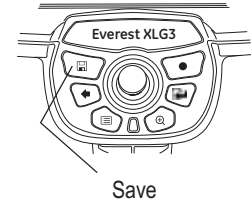
- **Normal**
Saves the image without calibration data. When you recall a normal image, you cannot take measurements.
- **Measurement**
Saves the image with calibration data for the selected measurement tip. When you recall a measurement image, you can take measurements.

Related Information

- [“To Save an Image” on page 66](#)
- [“Reviewing Settings for Image Format and Quality” on page 40](#)
- [“Managing Files & Communicating With Other Computers” on page 73](#)

To Save an Image

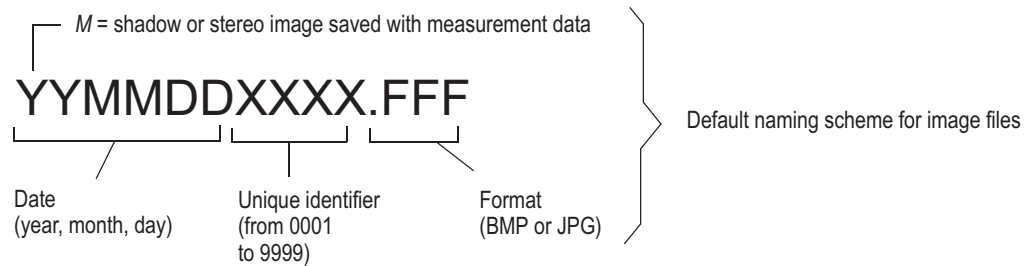
1. (Live or still images) Press .
-or-
(Still images only) Press . Select **Save** or **Save Image**.
2. If the choice is available, select **Normal** or **Measurement**.
3. Select the desired option or options.



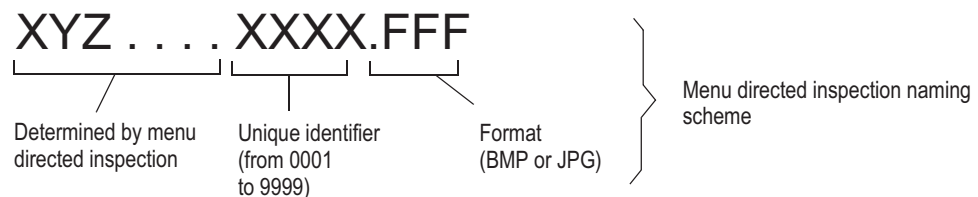
Option	Description
Save	Saves the image file.
Select Save Folder	Lets you select a save folder before you save the file. If you insert a storage device after selecting this menu item, select Refresh Drive List to update the list of choices.
Eject Hardware	(Applicable only for removable storage devices.) Ejects the storage device.
Rename Image	Lets you name the file before you save it. If you do not name the file before saving it, the system assigns a name.
Record Audio	Lets you speak into the microphone to record comments.
Play Audio	Plays recorded comments, if any.
Delete Audio	Deletes recorded comments, if any.

About Image File Names

Unless you run a menu directed inspection, images have a generic format. You can rename them after recalling them, or you can rename them any time from the desktop.



During a menu directed inspection, the file names are determined by the on-screen selections — files are automatically named.



Working With Videos

Any time during your inspection you can record video “in the background” while doing other tasks, such as adjusting brightness, comparing images on a split screen, capturing still images, taking measurements, managing files and folders, etc.

When you record video, the XLG3 system saves everything that appears on the display, including menus that you open, as well as background sounds and comments made near the microphone (unless you turn off the audio).

You can record video onto the internal drive, a DVD, or any other removable storage device.

Related Information

- [“About DVDs”](#) on page 68
- [“Recording Live Video”](#) on page 69
- [“Working With a Recalled Video”](#) on page 72

About DVDs

The optional DVD drive can be used for two purposes:

- to record live MPEG2 video files
- to archive saved files (images or videos)

Do not turn off the system while recording or archiving to a DVD, or you will lose data.

When video streaming is on, video cannot be recorded to the DVD drive. To learn how to turn video streaming on and off, see [“Reviewing Settings for Communications”](#) on page 45.



Caution DVD recording and archiving are sensitive to extremes of temperature, dust, vibration, and shock. For best results, minimize these factors.

DVD Types Accepted

The XLG3 system accepts both DVD+Rs and DVD-Rs.

You can record and/or archive to the same DVD multiple times until it is full.

SBC Version	DVD-R	DVD+R
	Maximum number of allowed starts, stops, and archived commands	Maximum number of allowed starts, stops, and archived commands
02.00.06	35	14
02.00.09	35	14
02.01.XX	33	10
Recommended Brands	Verbatim or Sony	Verbatim or Maxell

Initializing DVDs

If you start recording or archiving to a new DVD that has not been initialized manually, the system automatically initializes it before recording or archiving.

To Initialize a DVD Manually

1. Press .
2. Select **Video Record > DVD Initialize**.

The system initializes the DVD for about 2 minutes. After the DVD is initialized, you can start recording or archiving whenever you are ready.

Related Tasks

- [“Recording Live Video”](#) on page 69
- [“Archiving \(Copying\) Files to a DVD”](#) on page 77
- [“To Eject a DVD”](#) on page 74

Recording Live Video

Before recording video to a DVD, read [“About DVDs”](#) on page 68.

To Start Recording, Using Menus

1. Press  quickly.

- or -

Press . Select **Video Record > Recording Options**.

The Video Recording Options menu appears.

2. Select the desired option or options.

Option	Description
Start Recording	A flashing red dot appears. As long as this dot is flashing, the system is recording. If using a DVD, recording starts only after the DVD drive light stops flashing. If you start recording to a new DVD that has not been initialized manually, the system automatically initializes it before recording. See “Initializing DVDs” on page 68.
Cancel	Exits the menu without recording.
MPEG Quality	MPEG2 High or MPEG2 Low. For decision factors, see “Reviewing the Setting for Video Quality” on page 41.
Mic	On, muted or disabled.
Select Drives	Lets you select the drive or drives to record to. When you record to a DVD, it is recommended that you select a backup drive for simultaneous recording. When you record to a compact flash card, special considerations apply: <ul style="list-style-type: none"> • If you use a compact flash card, it must be an industrial card. • Videos are always saved to the compact flash slot at MPEG2 low quality, even if you select MPEG2 high. • If you record simultaneously to the compact flash slot and a DVD, videos are always saved at MPEG2 low quality to both media.
Select Save Folder	(For any drive other than DVD) Lets you select a save folder on the selected drive.
Name Video	Lets you name the file before recording. If you do not name the file before recording, the system assigns a name.

To Quick-Record, Bypassing Menus

Press and hold ●.

A flashing red dot appears. As long as this dot is flashing, the system is recording. If using a DVD, recording starts only after the DVD drive light stops flashing. If you start recording to a new DVD that has not been initialized manually, the system automatically initializes it before recording. See “Initializing DVDs” on page 68.

To Pause Recording

1. Press ● quickly.

- or -

Press . Select **Video Record > Pause**.

Recording stops temporarily. The pause symbol appears: **||**

2. When ready to resume, press ● again.

- or -

Press . Select **Video Record > Resume Recording**.

The red dot flashes again. Recording resumes.

Note Each time you pause and then resume video recording, the system continues saving to the same MPEG file. If you are recording to a DVD, the first pause or stop takes about a minute to process. The total number of times you can pause and stop varies with DVD type. See “[DVD Types Accepted](#)” on page 68.

To Stop Recording

Press and hold ●.

-or-

Press . Select **Video Record > Stop**.

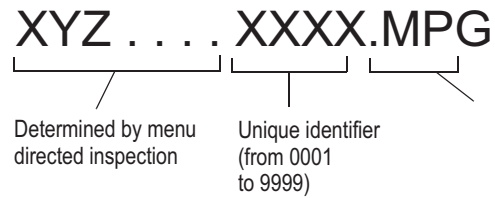
Note Each time you stop recording, the system creates a separate MPEG file. If you are recording to a DVD, the first pause or stop takes about a minute to process. The total number of times you can pause and stop varies with DVD type. See “[DVD Types Accepted](#)” on page 68.

About Video File Names

Unless you run a menu directed inspection, video files are named generically. You can rename them after recalling them, or you can rename them from the desktop.










During a menu-directed inspection, the video file names are determined by the on-screen selections, which automatically name video files for that inspection.



Working With a Recalled Video

To Work With a Recalled Video

1. If recalling a video from a DVD, verify that the DVD drive is selected.
Press . Select **Video Record > Recording Options > Select Drives > DVD**.
2. Recall the desired video.
 - a. Press .
 - b. Select **File Manager > Recall > drive or device**.
 - c. Select a video. It begins to play.
3. (Optional) Determine your next action.
 - Rename the video file.
Press . Playback pauses, and the Recalled Video menu appears. Select **Rename**. Enter a new file name. The new name overwrites the old. (Select **Play** to resume playback.) Note: Video files on a DVD cannot be renamed.
 - Capture a still image from the video.
Press . Playback pauses, and the Recalled Video menu appears. Select **Save Still Image**. Enter a file name. The paused image is saved as a JPEG or bitmap, depending on the settings. (Select **Play** to resume playback.)
 - Control playback by using the control buttons:

Playback Option	Control Button
Pause.	 or trigger
Resume playback when paused.	 or trigger
Fast-forward.	Pause then joystick right
Rewind.	Pause then joystick left
Close video.	

6 Managing Files & Communicating With Other Computers

About the Thumbnail Screen	73
Working With Removable Storage Devices	74
Recalling a File	75
Creating, Renaming, or Deleting Folders	75
Copying Files	75
Deleting Files	76
Renaming a File	76
Archiving (Copying) Files to a DVD	77
Using the Desktop	78
Sharing Files or Live Video With a PC	80

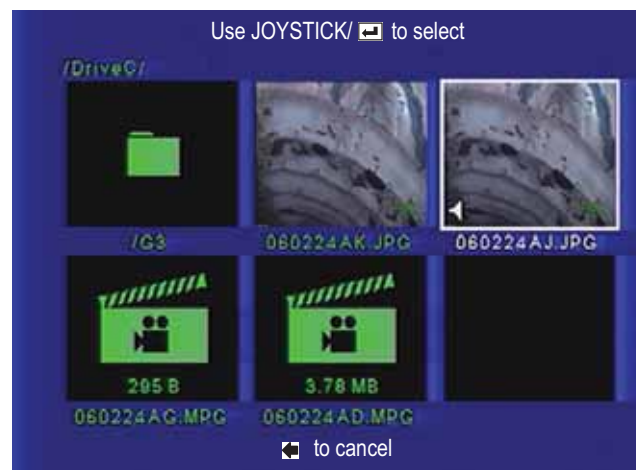
About the Thumbnail Screen

One way to manage files on the XLG3 system is to use the File Manager menu. When you use this menu, you select files from a thumbnail screen. Here is an example of a thumbnail screen showing an internal drive (DriveC) that contains the following items:

- a folder named “G3”
- two JPEG files
- two video files

The instructions on a thumbnail screen vary with the task: recalling, copying, deleting, etc.

To learn about an alternative way to manage files, see “[Using the Desktop](#)” on page 78.



🔊 = audio comments

🎥 = video

“M” at beginning of default file name = measurement image

Working With Removable Storage Devices

The XLG3 system is compatible with various removable storage devices: DVDs, Compact Flash cards, memory sticks, portable drives — any compatible USB-based or Compact Flash-based device.


All devices must be Windows formatted.

To Insert a Storage Device

Insert the device into the appropriate drive.

The system automatically detects and names the device. The system tries to assign each device a name based on information on the device itself. If no information is available, the system uses the name “Generic Storage Device.”

To Eject a Storage Device Other than DVD

1. Press .
2. Select **File Manager > Eject Hardware > device**.
3. When you see a message confirming that it is now safe to remove the device, remove the device.



Caution Always use the Eject Hardware menu command before you remove any storage device from any drive other than a DVD. If you remove a device without first using this command, data corruption or loss may result. The drive or device may also become temporarily unavailable.

To Eject a DVD


Press the button to the left of the DVD drive. You do not need to use the Eject Hardware menu command for DVDs.

For more, see [“About DVDs”](#) on page 68.

Recalling a File

Recalling a file means opening a saved image or video.


To Recall a File

1. Press .
2. Select **File Manager > Recall > drive or device**.
3. Select a file. It opens.

To learn about what you can do with a recalled file, see these sections:

- [“Working With a Recalled Image”](#) on page 51
- [“Working With a Recalled Video”](#) on page 72.

Creating, Renaming, or Deleting Folders


1. Press .
2. Select **File Manager > Folder**.
3. Select and perform the desired task.
 - Create
 - Rename
 - Delete

Copying Files

The Copy menu command lets you copy videos, still images, and audio files from the internal drive to any removable storage device except a DVD. While files are being copied, all functions except the File Manager and Setup menus are available.

To learn how to copy files to a DVD, see [“Archiving \(Copying\) Files to a DVD”](#) on page 77.

To Copy Files


1. Insert a storage device.
2. Press .
3. Select **File Manager > Copy**.
4. Select and perform the desired task.

Item	Description
Selected To	Copy selected files to the storage device.
All To	Copy all files to the storage device.
Folders To	Copy selected folders to the storage device.

Deleting Files

You can delete files from any removable storage device except a DVD.

To Delete Files


1. Press .
2. Select **File Manager > Delete**.
3. Select and perform the desired task.

Item	Description
Selected	Delete selected files.
All	Delete all files from the selected drive.
Folder	Delete the selected folder.

Renaming a File

You do not use the File Manager menu to rename files.

To Rename an Image or Video File

1. Recall the desired file.
2. Press .
3. Select **Rename** or **Rename Image**.
4. Enter a new file name. The new name overwrites the old.


Archiving (Copying) Files to a DVD

The Archive menu command lets you copy videos, still images, and audio files from the internal drive or from a removable storage device to a DVD. While files are being archived, all functions except the File Manager and Setup menus are available.

Before archiving, read [“About DVDs”](#) on page 68.

To learn how to copy files to other storage devices, see [“Copying Files”](#) on page 75.

To Archive Files to a DVD

1. Insert a DVD.
2. Press .
3. Select **File Manager > Archive**.
4. Select and perform the desired task.

Item	Description
Selected From	Copy selected files from the selected location.
All From	Copy all files from the selected location.
Folders From	Copy selected folders from the selected location.

If you start archiving to a new DVD that has not been initialized manually, the system automatically initializes it before archiving. See [“Initializing DVDs”](#) on page 68.

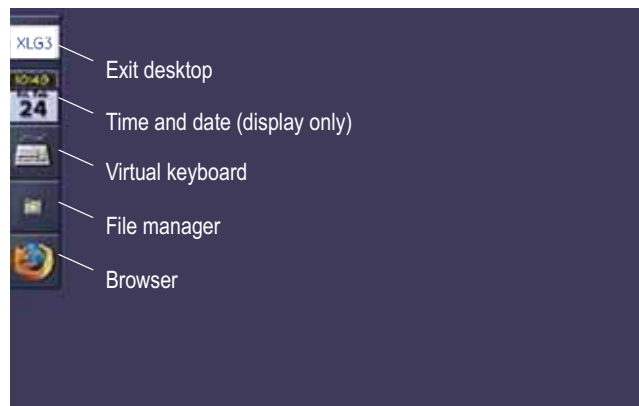
Using the Desktop

The virtual desktop is part of the optional network package. (See [“About the Network Package”](#) on page 5.)


With its graphical interface, the desktop does all of the following:

- Provides a familiar way to manage your files as an alternative to the File Manager menu.
- Gives you access to the Internet for viewing, downloading, or uploading web pages.
- Lets you use any outside e-mail service to send e-mail with files attached.
- Gives you access other applications, for example, a PDF reader.

The time and date icon on the desktop are for display only. To learn about changing the time and date, see [“Reviewing Settings for the System”](#) on page 44.

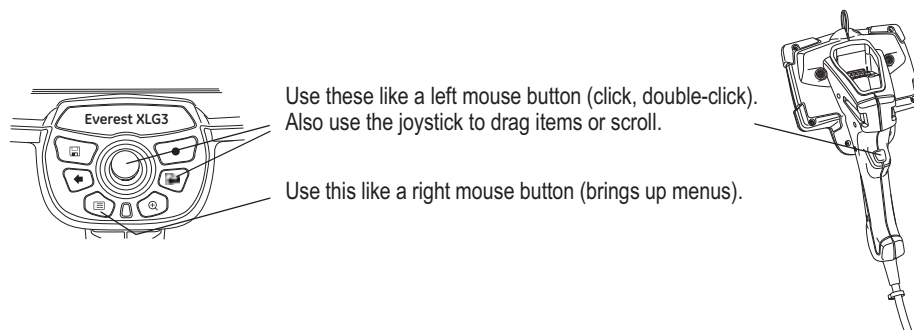


To Open the Desktop



1. While viewing a live image, press .
2. Select **Desktop**.

To Navigate the Desktop

If you do not have a mouse connected to your system, use the handset buttons to navigate the desktop.



To Manage Files from the Desktop

1. Double-click  .
2. If you do not have a keyboard connected to your system, double-click  .
3. Perform the desired tasks — create, rename, move, or delete files or folders — as you would from any computer desktop.


Note When using the desktop, if you copy or delete still images, the system does not copy or delete associated audio (WAV) files. Normally, when you use the File Manager menu to copy and delete, WAV files are treated as part of the image file, but when you manage files using the desktop, you must copy or delete WAV files manually.

To Open the Browser

Double-click  .

A Firefox browser window opens for Internet access.

To Exit the Desktop

Press  .

- or -

Double-click the **XLG3** icon on the desktop.

Sharing Files or Live Video With a PC

PC file sharing and video streaming — viewing live video from a PC — are part of the optional network package. (See [“About the Network Package”](#) on page 5.)

If the XLG3 system is connected to a router or network, you can send files back and forth between the system and other computers for viewing, remeasurement, or manipulation. You can also view live video on other computers. No drivers need to be installed.

Related Information


- [“To Establish Communication With a PC”](#) on page 81
- [“To View XLG3 Files at the PC”](#) on page 83
- [“To Manage Files From the PC”](#) on page 85
- [“To View Live Video From a PC \(Video Streaming\)”](#) on page 86

To Establish Communication With a PC

1. Connect the XLG3 system to the PC through a router or network.

For details, see “[Communicating to a PC Through a Router or Network](#)” on page 34.

2. At the XLG3 system, adjust communications settings as desired.

- a. Press . Select **Setup Menu > Communications**.
- b. Select one of these Remote File Access settings:
 - **Allow Read** — Select this if you only want to transfer files from the XLG3 system to the PC. Most people choose this option.
 - **Allow Read/Write** — Select this if you also want to transfer files from the PC to the XLG3 system.
- c. Verify that all other XLG3 communications settings are set as needed.

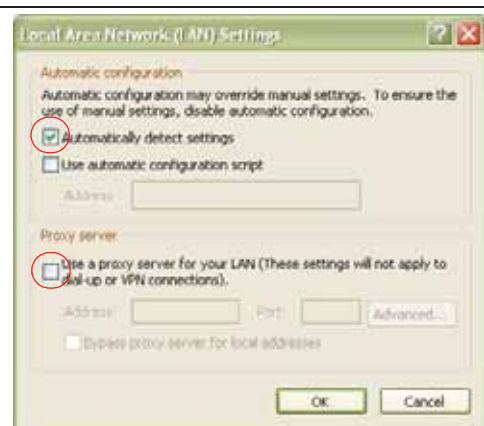
For details, see “[Reviewing Settings for Communications](#)” on page 45.


- d. Note the IP address. You will need it in Step 4.

IP Address Troubleshooting Tips

If you do not see an IP address in the XLG3 Communications menu and you are using Windows XP, verify your LAN settings as follows:

1. At the PC, open a browser window.
2. Select **Tools > Internet Options**.
3. Select the **Connections** tab.
4. Select **LAN Settings**. The Local Area Network (LAN) Settings screen appears, as shown here.
5. Verify that the **Automatically detect settings** box is checked, and the **Use a Proxy server for your LAN** box is unchecked.
6. Click **OK**.

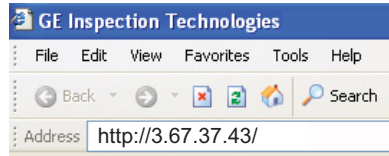


If you still do not see an IP address in the XLG3 Communications menu, refresh the screen by exiting and then wait approximately 20 seconds before reopening the Communications menu. (Press . Select **Setup Menu > Communications**.)

If you still do not see an IP address in the XLG3 Communications menu, reboot your XLG3 with the Ethernet cable connected to the XLG3 system.

The PC needs to be on the same network as the XLG3 system to be able to establish communication.

3. At the PC, open a browser window.
4. In the URL address field, type **http://** then the XLG3 system's IP address, as shown in this example. Do not include **XLG3**. Press **Enter**.



The Remote Browsing screen appears, as shown in this example.



You have now established communication.

Note: The first time this remote browse-in feature is accessed, your computer will be asked to download a Java application that allows Windows Internet Explorer to perform this remote browse in application. An Internet connection will be required to access this Java applet. Contact GE Inspection Technologies for this applet on CD-ROM if an internet connection is not available. To check if Java is running on your PC, or to determine if a newer version is available, go to: <http://java.com>

To View XLG3 Files at the PC

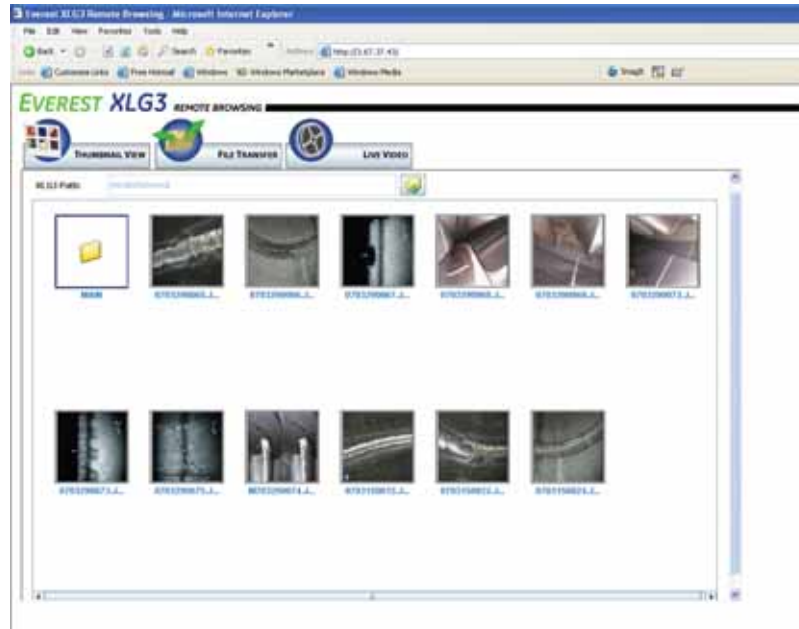
1. Establish communication with the PC.

For details, see “[To Establish Communication With a PC](#)” on page 81.

2. At the PC, select the **Thumbnail View** tab.

Thumbnail versions of files stored on the XLG3 system appear.

If no files appear, download the free software Java 1.5 or later at www.java.com.



3. Navigate to the desired location on the XLG3 internal drive or any external drive.

4. Double-click any thumbnail image. It becomes enlarged.

Manipulate it as desired using the buttons at the bottom of the screen.



To Manage Files From the PC

1. Establish communication with the PC.

For details, see “[To Establish Communication With a PC](#)” on page 81. Remember that **Allow Read/Write** must be selected in the XLG3 Communications settings.

2. At the PC, select the File Transfer tab.

Files stored on the XLG3 appear on the left; files stored on the PC appear on the right. If no files appear, download the free software Java 1.5 or later at www.java.com.



3. Navigate to the desired locations on each side, and select the desired files or folders.
4. Select the desired task button.
 - If transferring files to the XLG3 system, before you select the Transfer button, open the XLG3 folder named Internal, or one of the subfolders inside Internal, so that you will be able to find the files easily later.
 - If deleting files from the XLG3 system, note that you cannot delete folders containing files. You must first delete all files in the folder.

To View Live Video From a PC (Video Streaming)

1. Establish communication with the PC.

For details, see “[To Establish Communication With a PC](#)” on page 81.

2. Verify that video streaming is turned on.

For details, see “[Reviewing Settings for Communications](#)” on page 45.

3. At the PC, select the **Live Video** tab.

If VLC Media Player is not installed on your PC, a prompt appears, including downloading instructions. Download and install this plug-in.

4. Select **Play**.

Live video appears on the PC screen in near real-time (up to a 10-second lag). Live audio is also transmitted.

5. Control your viewing by using the buttons to the right of the video.

Note When video streaming is on, video cannot be recorded to the DVD drive.



7 Measuring Features and Defects

About Measuring	87
3D Phase Measurements	91
Stereo Measurements	96
Shadow Measurements	104
Comparison Measurements	110
Verifying Measurement Tips	112
Troubleshooting Measurements	113

About Measuring

Measurement capability is a standard feature on the XLG3 system. You can measure features or defects either before or after saving an image (if the image was saved in measurement mode). You can save up to five measurements per image. In order to perform 3D phase, stereo or shadow measurements, the image must be captured using a 3D phase, stereo or shadow tip.

Measurement results are valid only for measurements taken in air. For measurements taken in liquid, contact GE Inspection Technologies.

GE Inspection Technologies cannot guarantee the accuracy of measurements calculated by the XLG3 system. Accuracy varies with the operator's ability.

All measurement images saved using the XLG3 system, except for 3D phase images, can be remeasured on a PC using remeasurement software from GE's Inspection Technologies business. For details, see ["Communicating to a PC Through a Router or Network"](#) on page 34 (Step 5).

The XLG3 system can display measurement images that were captured on the Everest XL PRO™ VideoProbe system, including their previously captured measurements. However, you cannot remeasure these images on the XLG3 system.

About Measurement File Formats

You can save measurement images as JPEGs or bitmaps. You can view these files, including the measurement results, in most .BMP or .JPG viewing applications, such as Windows Paint. To learn how to change the file format, see ["Reviewing Settings for Image Format and Quality"](#) on page 40.

Types of Measurement

The XLG3 system supports four types of measurement: phase, stereo, shadow, and comparison.


Measurement Type	Advantages	Disadvantages
Phase	<p><i>Over stereo, shadow or comparison measurements:</i></p> <ul style="list-style-type: none"> Optical tip is used for both viewing and measurement. Automatic tip to target range-finding indicator. Full screen view. More accurate depth measurements. Cross-section profile measurement. Increased measurement distances are possible The surface need not be perpendicular to the tip. Cross-section profile view 3D point cloud view 	<p>The system cannot measure moving parts.</p> <p>Highly reflective surfaces should be measured at an angle.</p>
Stereo	<p><i>Over comparison measurements:</i></p> <ul style="list-style-type: none"> More accurate. No known reference is needed. Can measure depth. The surface does not need to be perpendicular to the probe view. <p><i>Over shadow measurements:</i></p> <ul style="list-style-type: none"> The surface does not need to be perpendicular to the probe view. 	<p>The system may be unable to position the matching cursors accurately with any of these conditions in the measurement area:</p> <ul style="list-style-type: none"> Insufficient detail Repeating patterns Glare Smooth, straight lines to measure along <p>In some cases, you can eliminate the problem by repositioning the probe tip and adjusting the brightness. Otherwise, try shadow measurement.</p>
Shadow	<p><i>Over comparison measurements:</i></p> <ul style="list-style-type: none"> More accurate. No known reference is needed. Can measure depth. Can measure distance along a skew surface. <p><i>Over stereo measurements:</i></p> <ul style="list-style-type: none"> Height and depth contours are more discernible. You can measure along smooth, straight lines. 	<p>Measurement surface must be nearly perpendicular to the probe view for an accurate measurement (except for "skew" measurements).</p> <p>The shadow is sometimes difficult to see.</p> <p>You cannot always place the shadow where you want it.</p>
Comparison	<p><i>Over shadow and stereo measurements:</i></p> <ul style="list-style-type: none"> You can use the probe headguard only. You can measure with probe tip farther away. You can measure large objects. You can check the approximate size of many items quickly. 	<p>Less accurate than shadow or stereo measurements.</p> <p>Known references may not be present and may be difficult to deliver to the measurement site.</p> <p>Measurement surface must be nearly perpendicular to the probe view for an accurate measurement.</p>

Related Information

- ["3D Phase Measurements"](#) on page 91
- ["Stereo Measurements"](#) on page 96
- ["Shadow Measurements"](#) on page 104
- ["Comparison Measurements"](#) on page 110

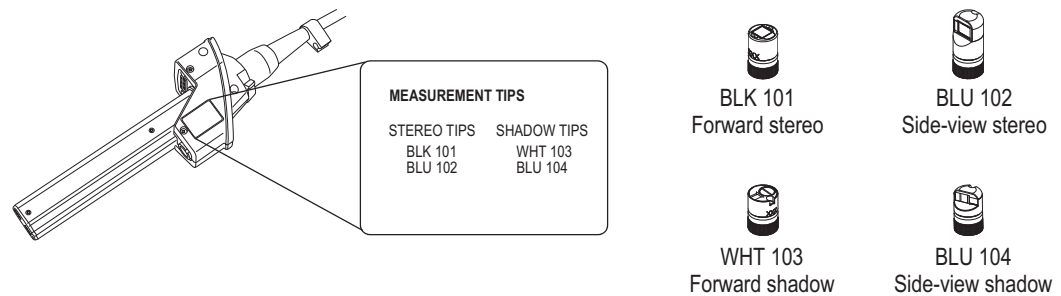
About the Measurement Tips

Unlike standard optical tips, 3D PhaseProbe[®], ShadowProbe[®] and StereoProbe[®] measurement tips are factory-calibrated for use with specific probes and will not measure accurately with other probes. These tips are matched to probes by the serial numbers identified on each optical tip and each probe label. Calibration data is stored in memory in the probe.

To ensure measurement accuracy, check each tip's calibration every twelve months. To display the calibration data, press . Then select **Setup Menu > Measure > Phase or Stereo or Shadow > Cal Info**.

To ensure that no mechanical damage has degraded their accuracy, verify measurement tips each time you use them. See “[Verifying Measurement Tips](#)” on page 112.

To learn which tips are available for which probes, see “[Optical Tips](#)” on page 147.



About the MTD Number

The 3D Phase Measurement system will display a number on-screen after a measurement is complete. While taking the measurement, an MTD number will appear (see the lower left corner of the figure below). MTD stands for *Maximum Target Distance* and is the distance from the 3D Phase Measurement tip to the surface at the point of the active cursor. 3D Phase Measurement systems do not use *Accuracy Index*.



About the Accuracy Index

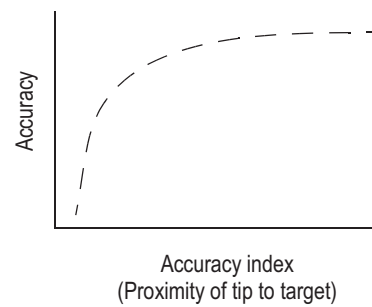
The accuracy index is a number that indicates the amount of magnification during shadow or stereo measurements. The higher the accuracy index, the greater the magnification, the more accurately you can place the measurement cursors, the more accurate your results.

When taking shadow or stereo measurements, you magnify the image not by zooming but by moving the optical tip as close as you can to the target.

To learn about the settings for the accuracy index — how to turn it on and off, and how to change the minimum value at which it flashes — see [“Reviewing Settings for Measurement”](#) on page 43.



The accuracy index can be displayed to indicate the amount of magnification you have achieved.



3D Phase Measurements

3D Phase Measurement optical tips and probe capture a three-dimensional surface scan of the object. Measurements are then made directly on the surface and displayed on the image. Preliminary steps of matching cursors or marking shadow lines are not necessary.

Taking 3D Phase Measurements

As with other measurement types, PhaseProbe accuracy improves as tip-to-target distance is reduced. The range finder bar icon can be used to gauge the suitability of the current tip-to-target distance for a given measurement. When the surface is too far for measurement, a single red bar is shown, and measurement should not be attempted. As the tip is moved closer to the surface, more bars are illuminated, and the color gradually transitions to green. Large length measurements may be performed with few bars illuminated, while still achieving good accuracy. In general, best accuracy is achieved by getting as close to the surface as possible.

Accuracy is generally best when viewing a surface from approximately a 45° angle, especially on surfaces that are shiny or have a speckled appearance.


When measuring surfaces with steps or long, deep features, a side view tip will give better results if the feature or step is horizontal. A front view tip will give better results if the feature or step is vertical. This is due to the LED orientations in the tips.

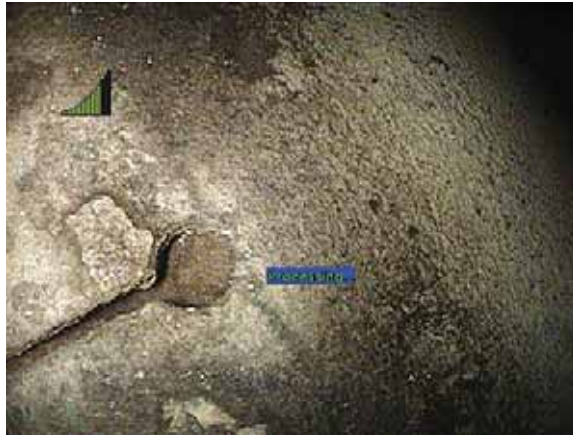




To Take a 3D Phase Measurement

1. Attach either a forward view or side view 3D Phase Measurement optical tip to the probe. Each measurement tip must be factory calibrated to a particular probe, and may be calibrated to more than one probe.
2. Verify that the XLG3 system has automatically identified the 3D Phase Measurement optical tip.
3. Initiate the Image Capture sequence in the following section.

3D Phase Measurement Image Capture

1. When the target is in position, press and hold the green  button or pull and hold the trigger. The 3D Phase Measurement scan will begin.
2. Hold the probe still for approximately one second during the surface scan. Multiple images are taken to complete the scan, and the probe must be held still during this sequence. After the “processing” message appears on-screen, the probe may be moved.



3. Press , then Select Measure>Phase> Measurement Type.
4. Place cursors on the desired feature, using  to aid in accurate placement. Up to five measurements may be placed on each image

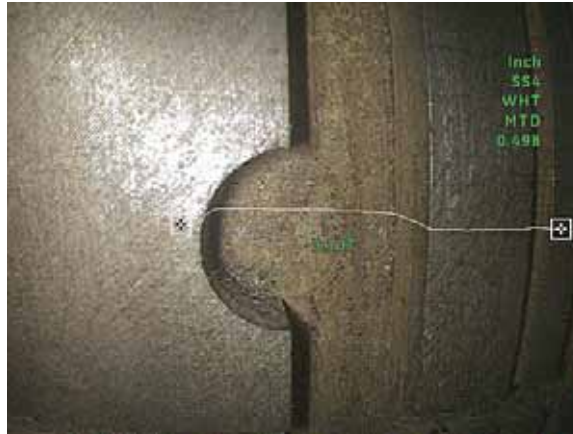
Point Cloud View

The point cloud view offers the following advantages:

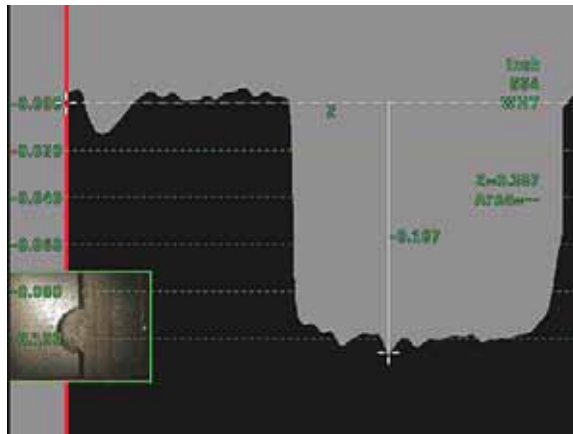
- Provides a rough idea of feature size from depth map (false color) mode scale.
- Shows location of high and low points to help profile and depth measurement cursor positioning.
- Show the level of noise relative to the defect size. You can then move the probe closer if the defect is hidden in noise bumps on the surface.
- Ripple or waves indicate dirt or oil on the gratings or reflections bouncing off one surface onto another.
- When entered with no measurements placed, you can see the entire captured surface.
- When entered with a measurement placed:
 - only the area around the measurement is shown
 - a reference plane is created using the measurement cursors
 - the cursor positions and the lines between the cursors are shown
 - for profile measurements, the profile slice along the surface and the line between the two cursors are shown
 - a square around the data, indicating the reference plane position, is shown
 - a scale indicates the depth or height relative to the reference plane

Profile Measurement

1. Place the first and second cursors on a flat surface on opposite sides of the area of interest. Profile cursors have a square box around the cursor to indicate they are creating a reference plane.
2. The XLG3 system will automatically draw a perpendicular line between the first and second cursor, across the surface of the target. The green dot along the line and dimension indicates the highest or lowest point from the reference surface. The profile slice is made perpendicular to the reference surface.



3. Once you have placed both reference cursors, press and hold the ENTER button to display the Profile View.


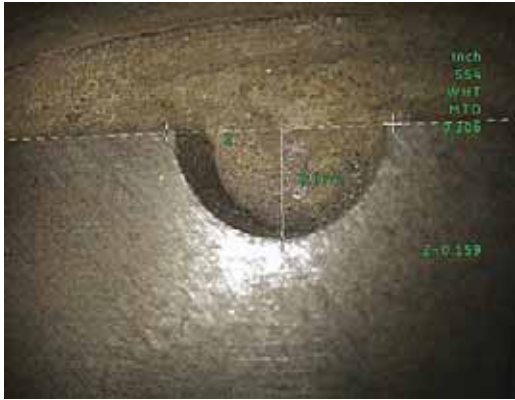



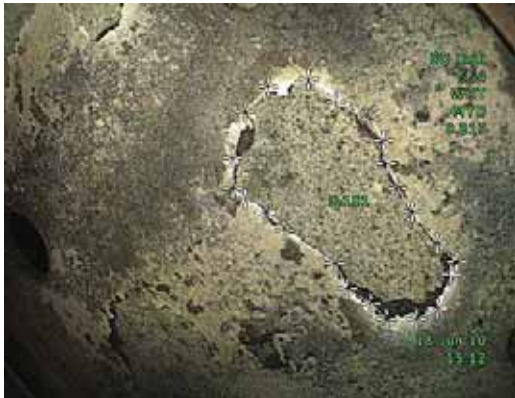

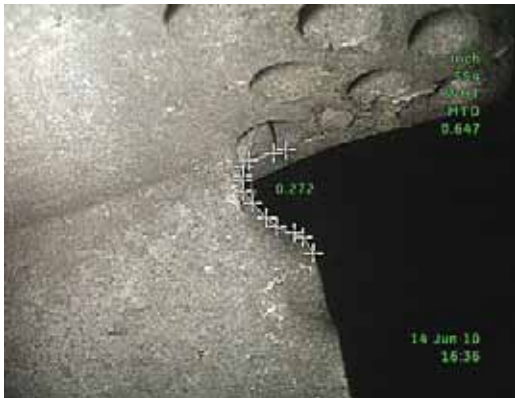



4. In Profile View, you may reposition all cursors and the measurement point by pressing ENTER to toggle between cursors, then using the joystick to reposition them.

Note: Small bumps seen in the profile view may be caused by noise. If the bumps are significant, relative to the feature being measured, the tip was too far from the surface. Another scan should be performed from a closer distance.

Types of 3D Phase Measurements

This table specifically addresses cursor placement for each type of 3D Phase measurement. For the complete procedure, see [“To Take a 3D Phase Measurement”](#) on page 91.

Type	Example	Description	Cursor Placement
Length		A linear (point-to-point) measurement.	Place both cursors at the desired locations.
Point to Line		The perpendicular distance from a point to a line.	Place the first two cursors to define a reference line. Place the third cursor at the perpendicular distance you want to measure.
Depth		The perpendicular distance between a surface and a point above or below it. Used to evaluate changes due to wear, misalignment, and other causes. Negative measurements indicate that the point lies below the plane. Positive measurements indicate that it lies above the plane.	Place the first three cursors to define a reference plane. Place the fourth cursor at the perpendicular distance you want to measure.

Type (cont.)	Example (cont.)	Description (cont.)	Cursor Placement (cont.)
Area		The surface area contained within multiple cursors placed around a feature or defect.	Place three or more cursors (up to 24) around the edge of the area you want to measure. When finished, press  twice. The area closes.
Multi-segment line		The length of a nonlinear feature or defect.	Place two or more measurement cursors (up to 24) to create line segments along the feature. When finished, press  twice. The line is finalized.
Depth Profile		A profile of the perpendicular distances from an area of interest to a specified surface.	Place two measurement cursors on a flat surface adjacent to the area of interest to create a reference plane. When finished, press and hold  to display the depth profile view.

Indication of Non-Measurable Area

When working with a 3D phase measurement image, certain parts of the image may not be measurable. These parts may be too far away, or be too dark, or obscured by light reflections if the surface is highly reflective. The 3D Phase Measurement system will display a red colored zone in those areas. To enhance measurement accuracy, the system will not allow an operator to place cursors in a red colored area.

The 3D Phase Measurement system will display a yellow colored zone in those areas where accuracy is reduced. Cursor placement in a yellow colored area should be avoided if possible.

Stereo Measurements

Stereo measurements require the use of StereoProbe measurement tips, which capture stereoscopic images of a target — two pictures of the same target from two different angles. To measure the target, the XLG3 processor uses triangulation based on these two side-by-side images.

You can take stereo measurements on a frozen image or on a recalled image that was saved in measurement mode.

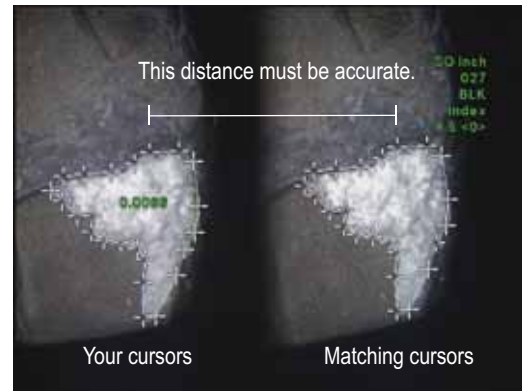
Related Information

Topic	Sections
Stereo measurement's advantages and disadvantages	"Types of Measurement" on page 88
Matching cursors, which make triangulation possible	"About the Matching Cursors" on page 97
How to perform stereo measurements	"To Position the Probe Tip for a Stereo Measurement Image" on page 98 "To Take a Stereo Measurement" on page 100 "Types of Stereo Measurement" on page 102

About the Matching Cursors

For each cursor you place on the left image during stereo measurement, the system places a matching cursor on the right image for use in triangulation.

You must place each left cursor on an image point (a pixel) that has sufficient surrounding detail to differentiate it from its neighboring pixels. If the neighboring pixels look the same as the point you choose — *especially the pixels to the point's left and right*, for example, pixels along a smooth horizontal line — the system cannot accurately place the matching cursor. When there is enough differentiating detail, the “match strength” is high (meaning that the generated match point clearly matches better than its neighboring pixels — the system’s confidence in the match is high). But if there is not enough detail, the match strength is low (meaning that the generated point and its neighboring pixels match almost equally well — the match may be correct, but the system’s confidence in the match is low).



For every matching cursor, the system calculates a match strength value between <0> (lowest confidence) and <5> (highest confidence). If too little detail is present, the system simply does not generate a matching cursor. Whenever possible, you want to achieve a match strength of at least <3>. If you can't, try capturing another image with less glare or more image details. (Adjust the tip orientation or brighten the image.)

Even when match strength is <5>, and especially when the match strength is lower, you need to verify that the matching cursor appears to be placed properly. A matching cursor that is off by just one pixel can have a significant impact on the measurement accuracy.

To Reposition a Matching Cursor

Note Matching cursors are most likely to be misplaced when the measurement area contains a repeating pattern. Generally, you get the best results by leaving the matching cursors exactly where the system places them.

1. If zoom windows are open, press \oplus to close them.
2. Move the matching cursor to the correct position, as described on the screen.

When you stop moving the cursor, the system optimizes the match position. (If you leave zoom windows on while moving the matching cursor, the system does not optimize the match position.)

Each manually corrected matching cursor is indicated by two things: a square around it, and the absence of a match strength number.

Taking Stereo Measurements

For maximum accuracy in any type of stereo measurement, you must begin by positioning the stereo tip carefully.

To Position the Probe Tip for a Stereo Measurement Image

Before freezing a stereo measurement image, position the probe tip to meet these criteria:

- **Visibility.** The item to be measured is fully visible on both sides of the screen.
- **Tip-to-target proximity.** The tip is as close as possible to the target while keeping it in focus.
- **Minimal glare.** Glare is minimized by adjusting the viewing angle and the image brightness in the areas where you will be placing cursors. Small glare speckles do not present a problem, but larger glare areas may appear in different positions on the two sides, causing false matches.
- **Vertical orientation.** If measuring distance between lines or across a circle, the image is oriented so that you can place cursors at left and right edges of the item to be measured — not at top, bottom or diagonal points. The system needs differentiated details to the left and right of each cursor to accurately place the matching cursors in horizontal relationship to the left-side cursors. For detailed explanation and illustration, see [“About the Matching Cursors”](#) on page 97.



Both images were captured for length measurement across the slot.

Bad Example

- Object is not fully visible on right side.
- Object is not well lit. (Optical tip needs to move closer to surface.)
- Object is not oriented to allow placement of cursors at left and right edges of circle or gap.



Good Example


- Object is fully visible on both sides.
- Object is well lit with minimal glare.
- Object is oriented to allow placement of cursors at left and right edges of circle or gap.

Note: The system cannot accurately match points *along* a smooth, straight line. To measure along a smooth, straight line, use shadow measurement. (If you must use stereo measurement, orient the image so that the line is vertical.)

About Single View



While you are positioning the stereo tip, you may want to turn on Single View, which temporarily eliminates the second image, making it easier to aim the camera.

To Turn On Single View

1. While viewing a live stereo image, press .
2. Select **Image > Single View > On**.

To Exit Single View

Do one of the following:

- To return to the live dual image, press .
- To freeze the image and proceed with measuring, press .



Single View

To Take a Stereo Measurement

1. Attach the stereo tip securely, and verify it.

See [“Verifying Measurement Tips”](#) on page 112.

2. Position the probe tip for maximum accuracy.


See [“To Position the Probe Tip for a Stereo Measurement Image”](#) on page 98.

3. Freeze the image.

4. Select the measurement type and tip.

Press . Select **Measure** > **Stereo** > *measurement type* > *tip*.

5. Place the cursors in the left half-screen, as described on the screen.

Measurement accuracy depends on all cursors being positioned accurately. For best accuracy in cursor placement, press  to activate the zoom window for a close-up view of the image around the active cursor.

To learn how to place cursors for specific measurement types, see [“Types of Stereo Measurement”](#) on page 102.

As you move each cursor, the matching cursor in the right half-screen moves accordingly.

6. Inspect each matching cursor as soon as it appears.

Generally, you get the best results by leaving the matching cursors exactly where the system places them. However, under certain circumstances, such as when a repeating pattern exists, you may need to help the system find the correct match. For details, see [“About the Matching Cursors”](#) on page 97.




7. (Optional) Reposition the left-side cursors and the measurement result. Reinspect the matching cursors.

8. (Optional) Verify your measurement accuracy.

Move each left-side cursor a few pixels. If the matching cursors move identically, and if the results change only a little, you have probably achieved accurate results. But if a matching cursor's movement is erratic, or if the results change significantly, your results are unreliable. Capture a fresh image, following the guidelines under [“To Position the Probe Tip for a Stereo Measurement Image”](#) on page 98.

Note This step is especially useful if you have to use a low accuracy index (less than 5) or low match strength (less than 3). For example, you might have to use a low accuracy index if you are measuring a large object or if you have limited access and cannot bring the tip close to the target. You might have to use low match strength if the surface has few details.

9. (Optional) Perform any of these tasks:

Task	Menu Item
Add measurements, up to five total.	Press  . Select Measure > Add .
Clear some or all measurements.	Press  . Select Measure > Clear measurement .
Select the correct tip in the software (if the selected tip is not the one that you are using).	Press  . Select Measure > Tip .

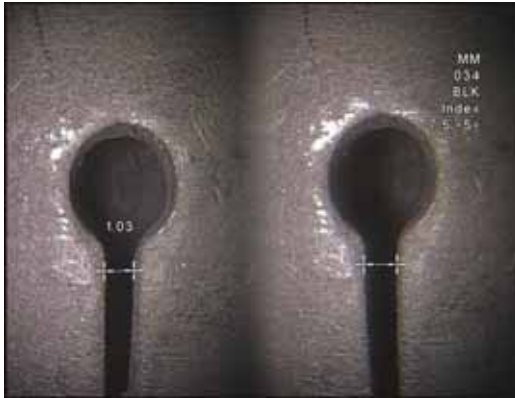
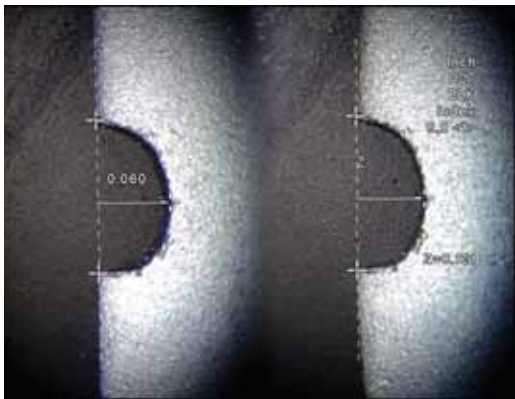
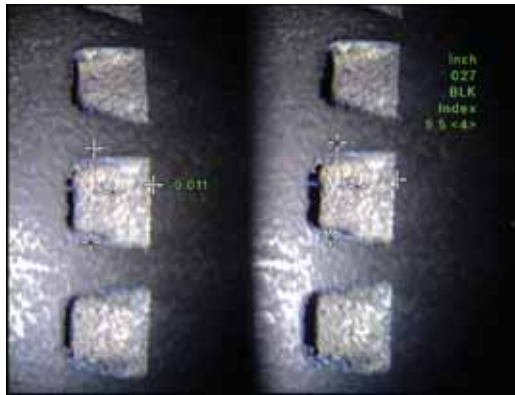
10. Save the image.





Press . For details, see [“Saving an Image”](#) on page 65.

Note Stereo images are saved without zoom windows, borders, and certain other screen graphics. This way, more of the image is visible if you recall it for remeasurement.

Types of Stereo Measurement

This table specifically addresses cursor placement for each type of stereo measurement. For the complete procedure, see [“To Take a Stereo Measurement”](#) on page 100.

Type	Example — “Matching Cursors” on Right Image	Description	Cursor Placement On Left Image
Length		A linear (point-to-point) measurement.	Place both cursors.
Point to Line		The perpendicular distance from a point to a line.	Place the first two cursors to define a reference line. Place the third cursor at the perpendicular distance you want to measure.
Depth		The perpendicular distance between a surface and a point above or below it. Used to evaluate changes due to wear, misalignment, and other causes.	Place the first three cursors to define a reference plane. Place the fourth cursor at the perpendicular distance you want to measure. Note: Depth measurements taken at a low accuracy index are particularly sensitive to the matching cursor's position. If the accuracy index is low, increase it by bringing the probe tip closer. If you cannot increase the accuracy index, place cursors so that they yield high match strengths, and verify your accuracy as described in Step 8 on page 100.

Type (cont.)	Example — “Matching Cursors” on Right Image (cont.)	Description (cont.)	Cursor Placement On Left Image (cont.)
Area		<p>The surface area contained within multiple cursors placed around a feature or defect.</p>	<p>Place three or more cursors (up to 24) around the edge of the area you want to measure.</p> <p>When finished, press  twice. The area closes.</p>
Multi-segment line		<p>The length of a nonlinear feature or defect.</p>	<p>Place two or more measurement cursors (up to 24) to create segments along the feature.</p> <p>When finished, press  twice. The line is finalized.</p>

Shadow Measurements

Shadow measurements require the use of ShadowProbe measurement tips, which project a shadow onto a target. To measure the target, the XLG3 processor uses triangulation based on the shadow's location. You can take shadow measurements on a frozen image or on a recalled image that was saved in measurement mode.

Related Information

Topic	Sections
Shadow measurement's advantages and disadvantages	"Types of Measurement" on page 88
How to perform shadow measurements	"To Position the Probe Tip for a Shadow Measurement Image" on page 105 "To Take a Shadow Measurement" on page 107 "Types of Shadow Measurement" on page 108

Taking Shadow Measurements

For maximum accuracy in any type of shadow measurement, you begin by positioning the shadow tip carefully.

To Position the Probe Tip for a Shadow Measurement Image

Before freezing a shadow measurement image, position the probe tip to meet these criteria:

- **Tip-to-target proximity.** The tip is as close to the surface as possible while still viewing the entire item to be measured. The shadow moves toward the left as the tip approaches. Measurements can be made even if the tip is so close that the image is somewhat out of focus, as long as the features are sharp enough to place the cursors accurately.

For depth measurements, in particular, the tip needs to be close enough to noticeably break the shadow so that the system can accurately differentiate between the raised and recessed surfaces.

- **Perpendicular surface.** There are two criteria here. (1) The shadow is straight up and down, indicating that the surface is vertically perpendicular to the probe view. (2) Visual cues, such as illumination and perspective, indicate that the surface is approximately perpendicular to the probe view horizontally as well.
- **Shadow's proximity to item.** The shadow is near, and on the same plane as, the item you want to measure.



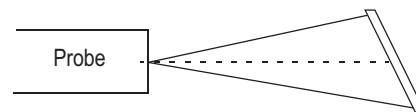
Both images were captured for length measurement across the slot.



Bad Example

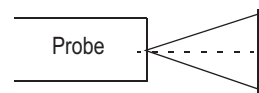
- Shadow is on right side of screen.
(Optical tip needs to move closer to surface.)
- Shadow is not quite vertical, and surface appears skew.
(Surface is neither vertically nor horizontally perpendicular to probe view.)

Note: Linear measurements can be taken on a skew surface, but only if you select the "skew" measurement type.



Good Example

- Shadow is further left.
(Optical tip is very close to surface.)
- Shadow is vertical, and surface does not appear skew.
(Surface is perpendicular to probe view.)
- Shadow is on same plane as item to be measured.





Both images were captured for depth measurement.



Bad Example



From this in-focus distance, there is little difference between the shadow positions on the raised and recessed surfaces, so you are unlikely to get an accurate depth measurement.

Good Example

With the tip closer to the surface, even though the image becomes blurry, the break in the shadow is more significant, so you are more likely to get an accurate depth measurement.






Note: For both depth and skew measurements, the points that you want to measure must fall in the horizontal center of the shadow.


To Take a Shadow Measurement

1. Attach the shadow tip securely, and verify it.
See [“Verifying Measurement Tips”](#) on page 112.
2. Position the probe tip for maximum accuracy.
See [“To Position the Probe Tip for a Shadow Measurement Image”](#) on page 105.
3. Freeze the image.
4. Select the measurement type and tip.
Press . Select **Measure > Shadow > measurement type > tip**.
5. If a vertical dashed line (called the *shadow line*) appears, center it over the shadow.
Measurement accuracy depends on centering this line accurately.
6. Place the cursors.
Measurement accuracy depends on all cursors being positioned accurately. For best accuracy in cursor placement, press  to activate the zoom window for a close-up view of the image around the active cursor.

To learn how to place cursors for specific measurement types, see [“Types of Shadow Measurement”](#) on page 108.

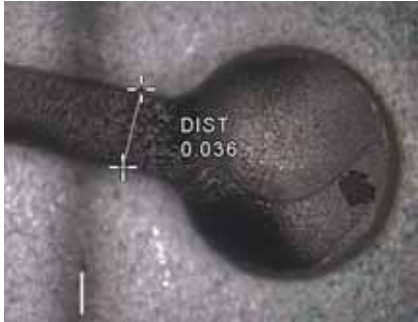
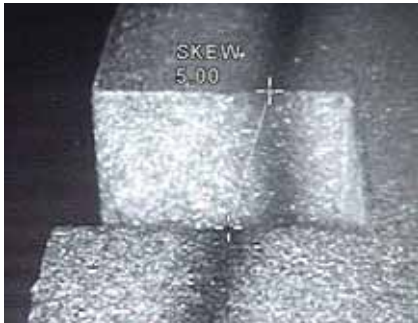
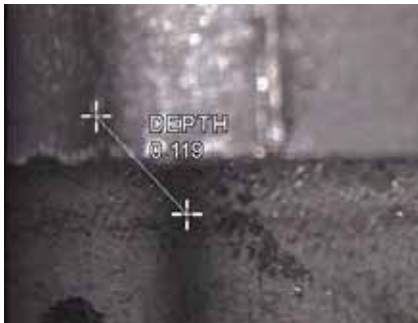
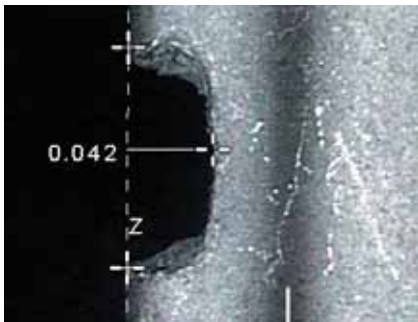
7. (Optional) Reposition the cursors and the measurement result.
8. (Optional) Perform any of these tasks:

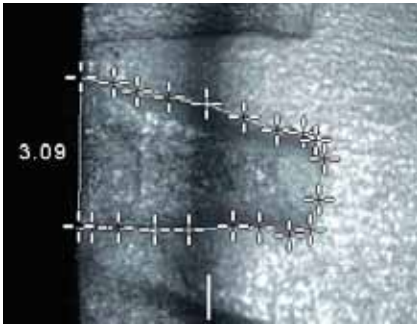




Task	Menu Item
Add measurements, up to five total.	Press  . Select Measure > Add .
Clear some or all measurements.	Press  . Select Measure > Clear measurement .
Select the correct tip in the software (if the selected tip is not the one that you are using).	Press  . Select Measure > Tip .
Adjust the shadow line's position.	Press  . Select Measure > Move Shadow Line . (Shortcut: Hold  .)

9. Save the image.
Press . For details, see [“Saving an Image”](#) on page 65.

Types of Shadow Measurement

This table specifically addresses cursor placement for each type of shadow measurement. For the complete procedure, see [“To Take a Shadow Measurement”](#) on page 107.

Type	Example	Description	Cursor Placement
Distance		A linear (point-to-point) measurement.	Place cursors on or near the shadow.
Skew		A linear (point-to-point) measurement on a surface that is not perpendicular to the probe view. Take a skew measurement only if you cannot obtain a vertical shadow.	Place cursors in the horizontal center of the shadow.
Depth		The perpendicular distance between a surface and a point above or below it. Used to evaluate changes due to wear, misalignment, and other causes. The shadow is further left on the surface that is closer to the probe tip.	Place cursors on the raised and recessed surfaces in the horizontal center of each shadow.
Point to line		The perpendicular distance from a point to a line.	Place the first two cursors to define a reference line. Place the third cursor at the perpendicular distance you want to measure.

Type (cont.)	Example (cont.)	Description (cont.)	Cursor Placement (cont.)
Area		The surface area around a feature or defect.	Place three or more cursors (up to 24) around the edge of the area you want to measure. When finished, press  twice. The area closes.
Multi-segment length		The length of a nonlinear feature or defect.	Place two or more measurement cursors (up to 24) to create segments along the feature. When finished, press  twice. The line is finalized.
Circle gauge		A quick, "go – no go" method of determining whether defects fall within allowable limits.	Place circle on or near the shadow.

Comparison Measurements

Comparison measurements rely on the known dimensions of an object that has been set in the field of view either by the manufacturer or by the probe. The XLG3 processor uses these known dimensions as a reference scale for measuring an unknown target.

You can take comparison measurements on a frozen image or on a recalled image that was saved in measurement mode.

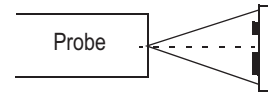
Related Information


Topic	Sections
Comparison measurement's advantages and disadvantages	"Types of Measurement" on page 88
How to perform comparison measurements	"Taking Comparison Measurements" on page 111

Taking Comparison Measurements

1. Attach any standard forward-view or side-view tip to the probe.
2. Position the probe tip for maximum accuracy:

- The surface should appear perpendicular to the probe view.
- The target and known object should both be in the same view and plane.
- The tip should be as close as possible to the target.



3. If the object and reference are small on the screen, zoom in.
Press  until the known object and the target fill the screen as much as possible.

4. Freeze the image.
5. Select the measurement type.

Press . Select **Measure** > **Comparison** > *measurement type*.




6. Establish the reference distance.

Place the two reference cursors at the endpoints of a known distance. Then adjust the displayed number until it matches that distance.

7. Place the cursors for the feature or defect you want to measure.

To learn how to place cursors for a particular type of comparison measurement, follow the same instructions as for “[Types of Shadow Measurement](#)” on page 108.

8. (Optional) Reposition the cursors and measurement result.
9. (Optional) Perform any of these tasks:

Task	Menu Item
Add measurements, up to five total.	Press  . Select Measure > Add .
Clear some or all measurements.	Press  . Select Measure > Clear measurement .
Establish a new reference dimension.	Press  . Select Measure > New Ref Dim .

10. Save the image.

Press . For details, see “[Saving an Image](#)” on page 65.

Verifying Measurement Tips

Verify measurement tips each time you use them to ensure that no mechanical damage has degraded their accuracy.

Every XLG3 system equipped with measurement capability is shipped with a measurement verification block. This tool lets you verify the accuracy of measurement tips. It contains optical measurement targets whose accuracy is traceable to the United States National Institute of Standards and Technology (NIST) measurement standards.

These are the part numbers for the verification blocks used with the XLG3 system:

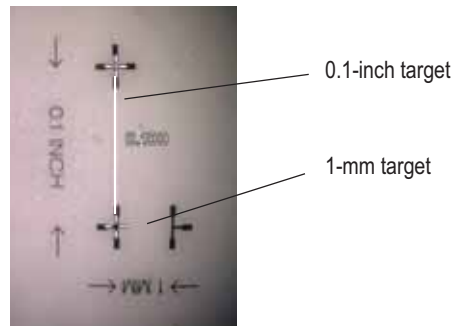
VER2400B	For 3.9 mm systems
VER2600C	For 6.1 mm systems
XLG3TM84VER	For 8.4 mm systems

Each measurement verification block comes with a calibration schedule and a certificate of calibration (C of C), which notes the calibration date and due date.

Measurement verification block



Test targets inside block



To Verify a 3D Phase, ShadowProbe or StereoProbe Measurement Tip


1. Attach the measurement tip securely.
2. Insert the tip into the appropriate test chamber.
3. Measure the test target that matches the units you use: inches or mm.
4. Evaluate your results.


An experienced user can achieve a measurement of 0.100 ± 0.005 inches (1.00 ± 0.05 mm). If your measurement does not fall within these limits, try the suggestions under [“Troubleshooting Measurements”](#) on page 113.

Troubleshooting Measurements

Help: I'm Getting Inaccurate 3D Phase or Stereo or Shadow Measurements

Move the probe tip as close as possible to the target, maximizing magnification.

After capturing an image, verify that the tip attached to the probe matches the tip that is selected in the software. Press . Select **Measure > Tip** (For 3D phase measurements, the tip serial number is shown in the corner of the measurement screen).

Verify that you have selected the correct type of measurement. Press . Select **Measure > Phase or Shadow or Stereo > measurement type**.

Verify that the optical tip is threaded on to the probe head securely.

Measure the target contained in the verification block to ensure that no tip damage has occurred. See [“Verifying Measurement Tips”](#) on page 112.

Help: I'm Getting Inaccurate 3D Phase Measurements

Be sure to hold the probe still for approximately one second during the surface scan. Do not move the probe until after the “processing” message appears on-screen.

Reposition the probe tip until the range finder bar pattern on the Live screen shows the maximum possible number of green bars. It is acceptable to be slightly out of focus for very small defects.

Make sure the gratings are clean.

Try a non-perpendicular view, such as 30-45°. This often significantly decreases the noise level in the data, especially for surfaces that are shiny or have a speckled appearance.

Check with verification block. Check point cloud view for excessive waviness or ripple, which would indicate dirt or oil contamination or tip damage.

Help: I'm Getting Inaccurate Stereo Measurements

Avoid placing cursors in areas of significant glare. If necessary, adjust the brightness or reposition the probe tip to enhance details and reduce glare.

Verify that the object to be measured is near the center of the screen.

Verify that the matching cursor is correct within 1 pixel. If you cannot clearly see where the match point should be, select a different point, or capture the image from a different angle that better reveals details to allow better matching.

Activate the zoom window to most accurately place the measurement cursors.

Try shadow measurement instead if there is little detail in the measurement area, or if you need to measure along smooth, straight lines.

Review guidelines under [“To Position the Probe Tip for a Stereo Measurement Image”](#) on page 98.

Help: I'm Getting Inaccurate Shadow Measurements

Verify that the surface is perpendicular to the probe view for all but skew measurements.

Verify that the shadow is properly oriented, the vertical dashed line (if any) is centered, and the cursors are properly placed.

Review guidelines under [“To Position the Probe Tip for a Shadow Measurement Image”](#) on page 105.

8 Maintenance

Inspecting and Cleaning the System	115
Replacing the Lamp	118
Checking and Replacing the Fuses	120
Maintaining the Battery	122
Replacing the Internal Memory Card	125

Inspecting and Cleaning the System

Inspect and clean the XLG3 system before and after each use. If using the system in a dirty environment, clean the components more frequently as needed.

If images are distorted or blurred within normal range, and if the optical tip is securely threaded, the most likely problem is dirty optical surfaces. For best image quality, clean the optical tip and camera head frequently.

If you discover conditions that require evaluation or repair, return the system to GE Inspection Technologies. Early repair of minor conditions can prevent much more costly repair.



Caution Do not immerse or soak the handset or the probe power plug.

To Inspect and Clean an Optical Tip

1. Check the optical tip for damage or contamination.
2. Clean all external parts of the optical tip. Use glass cleaner or 70% alcohol-to-water solution and a pointed cotton swab.



3. Clean only the internal threads of the optical tip. The internal optical lens should only be cleaned when troubleshooting an optical tip that provides poor focus.



Caution The internal optical lens is surrounded by an o-ring. Use care not to dislodge the o-ring.



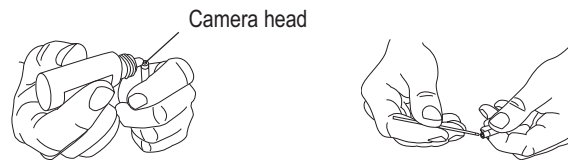
Caution For 3D phase measurement optical tips, do not use a cotton swab to clean the inside of the tip or damage to the tip may occur.

To Inspect and Clean a Probe

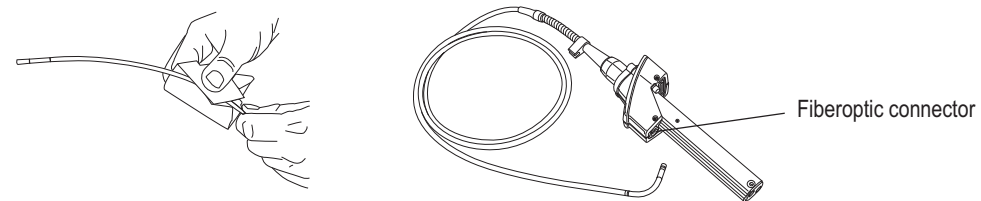
1. Check the probe for damage or contamination. Look for excessive wear in the bending neck, loose strands of the braided weave, or separation of the bonding joints.



2. Clean the probe tip, including the lens on the camera head. Use glass cleaner or 70% alcohol-to-water solution and a pointed cotton swab.

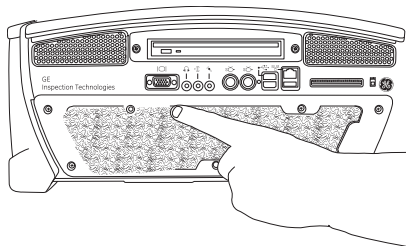


3. Clean the rest of the probe, including insertion tube and fiberoptic connector. Use a soft cloth dampened with glass cleaner or 70% alcohol-to-water solution.



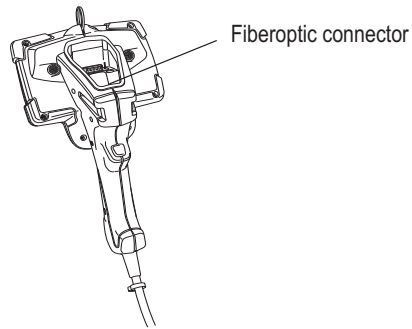
To Inspect and Clean a Dust Filter

1. Check to see if the dust filter has become clogged, reducing airflow and preventing proper cooling.
2. If necessary, remove the filter, rinse it with water, and let it dry completely. Or replace it with a new filter: part number XLG3AFILTER.



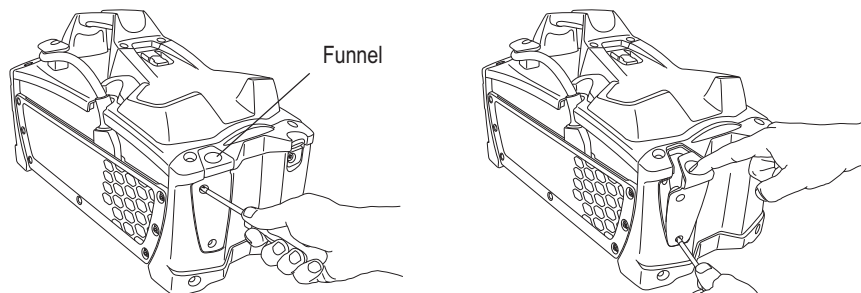
To Inspect and Clean the Handset

1. Disconnect the power cord from the power source.
2. Check for damage or contamination, including any bent pins on the electrical connector.
3. Clean all parts of the handset, including the fiberoptic connector. Use a soft cloth dampened with glass cleaner or 70% alcohol-to-water solution.



To Clean the Insertion Tube Storage Reel

1. Disconnect the AC power cord from the power source.
2. Remove the insertion tube from the funnel.
3. Loosen the two screws, and remove the funnel.



4. Wipe inside the funnel and inside the reel. Use a soft cloth dampened with glass cleaner or 70% alcohol-to-water solution.
5. Replace the access panel.

Replacing the Lamp

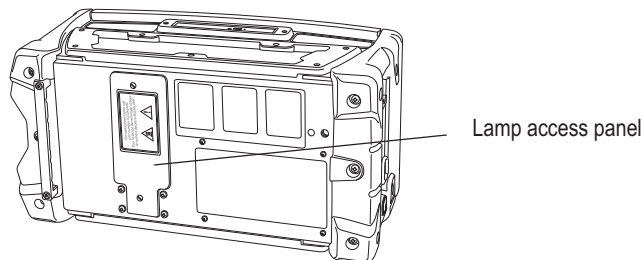
To Determine Whether to Replace the Lamp

If the lamp does not come on when you turn the power switch on, verify all of the following things before replacing the lamp.

- The probe is properly latched in the handset.
- The lamp was correctly installed.
- The system was not turned on too quickly after being turned off. (Leave the system off for at least 15 seconds so that it can complete its shutdown sequence. Then turn it back on.)
- The system is not too hot. (The lamp shuts down in over-temperature conditions.)
- The power switch's green LED lights up when the switch is on. If not, see [“Power”](#) on page 128.

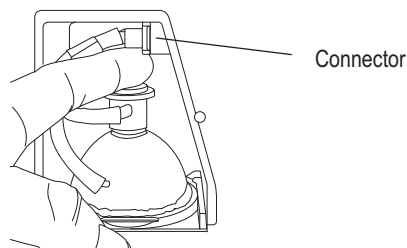
To Remove the Lamp

1. Disconnect all sources of power.
 - If using AC power, disconnect the power cord from the power source.
 - If a battery is installed, disconnect and remove it. See [“To Remove the Battery”](#) on page 122.
2. Unscrew and remove the lamp access panel.



WARNING LAMP MAY BE HOT. Could cause burns. If the lamp has been on, wait 10 minutes for it to cool.

3. Disconnect the connector above the lamp. Gently remove the lamp.



To Install a Lamp

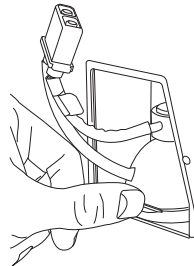


Caution Do not touch the interior of the lamp's glass reflector or the inner lamp tube. Oils from your fingers will shorten the working life of the lamp and could cause it to explode.

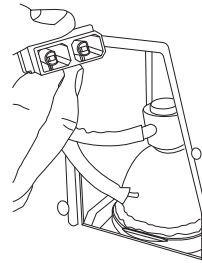


Caution Only use GE Inspection Technologies lamps, part number XLG3ALAMP.

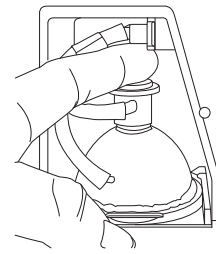
1. Remove a new lamp from its box. Handle it by the metal rim or by the ceramic socket only.
2. Install the lamp.
 - a. Position the new lamp so that the flat spot on the metal rim is toward the left side. Slide the lamp all the way in, past the snap springs. Push down to seat.
 - b. Orient the connector with square edge toward door opening. The connector only goes in one way.
 - c. Plug in the connector. Do not force it. Seat the connector fully with fingertip.



a



b




c

3. Reinstall the lamp door.
If you can't install the door, reseal the lamp.
4. Reconnect to power, and turn the system on.
5. Execute a white balance.

To Execute a White Balance

A white balance corrects the color so that white appears white despite any slight hues that may be present under varying lighting and ambient conditions.

1. Press . Select **Setup Menu > White Balance**.
2. Point the probe at a blank white piece of paper.
3. Select the desired item:
 - **Execute**
Corrects the color for current conditions.
 - **Default**
Restores the original factory setting.

Checking and Replacing the Fuses

If the system power switch is on but the system is not powering up, try the troubleshooting tips under “Power” on page 128. If necessary, check or replace fuses. Use the same fuse type and rating. For fuse values, see “Fuses” on page 131.



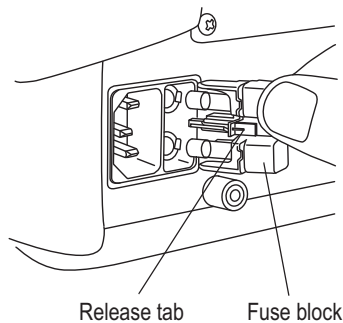
Caution If, after replacing a fuse, the new fuse blows, contact GE Inspection Technologies.

To Check or Replace the AC Fuses

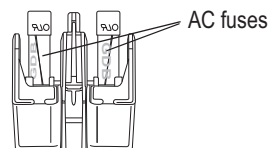


WARNING Before checking or replacing the AC fuses, always turn power switch off, and unplug AC power cord from the base unit. Exposure to live AC power could result in serious injury or death.

1. Turn off the power switch. Unplug the AC power cord from the base unit.
2. Verify that the AC power cord and power source are both working properly.
 - If not, fix the problem.
 - If so, go to Step 3.
3. Squeeze the release tab on the AC fuse block, and remove the fuse block.



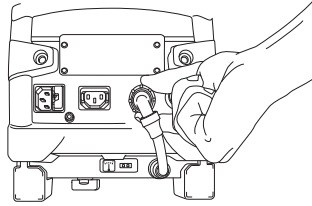
4. Remove the fuses by pulling both out firmly.



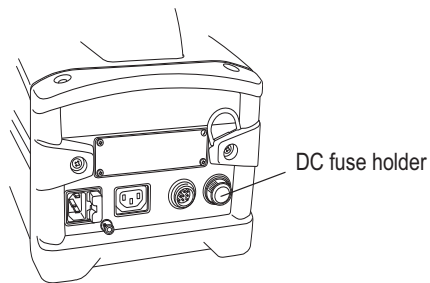
5. Inspect each fuse. If the glass appears cloudy, the fuse is blown. Replace any blown fuse.
6. Reinsert the fuse block.

To Check or Replace the Battery (DC) Fuse

1. Turn off the power switch.
2. Unplug the DC power connector.



3. Turn the DC fuse holder counterclockwise.



4. Remove the fuse, and check it with an ohmmeter.
 - If < 1.0 ohm, the fuse is good.
 - If > 1.0 ohm, replace with a new fuse.

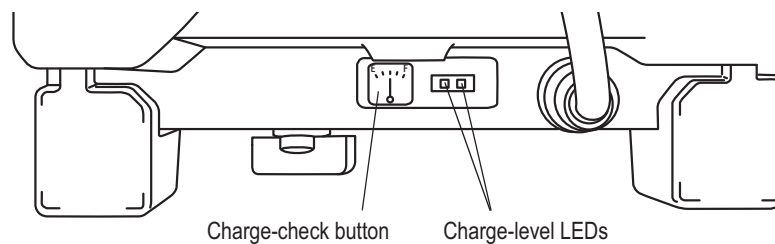
Maintaining the Battery

To Check the Battery's Charge Level

While the battery is in use, press the charge-check button. The green and red LEDs light up according to the battery's charge level, as shown here.

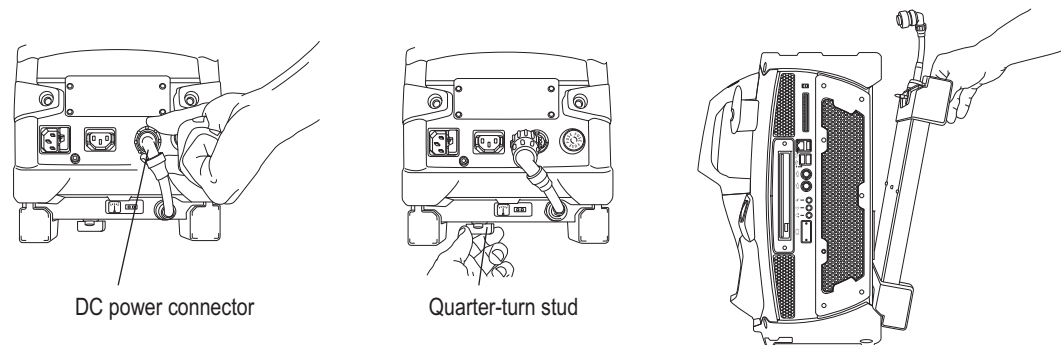
LED Status	Battery Charge Level
Green on	> 80%
Red on	< 80%
Red flashing	Very low
Both off	No charge

These two LEDs do not light up until you press the button.



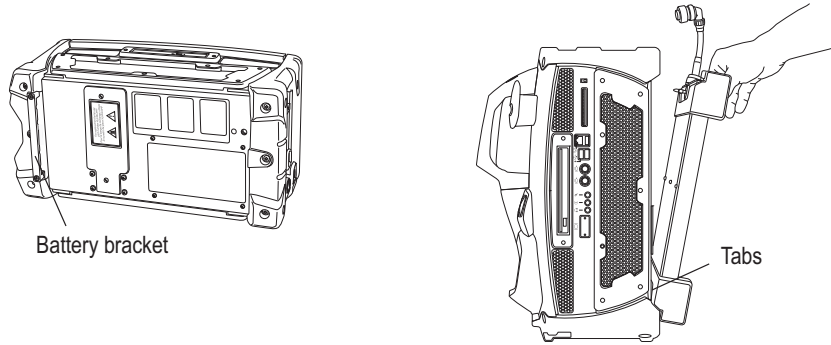
To Remove the Battery

1. Turn off the power switch.
2. Unplug the DC power connector.
3. Turn the quarter-turn stud counterclockwise.
4. Remove the battery.

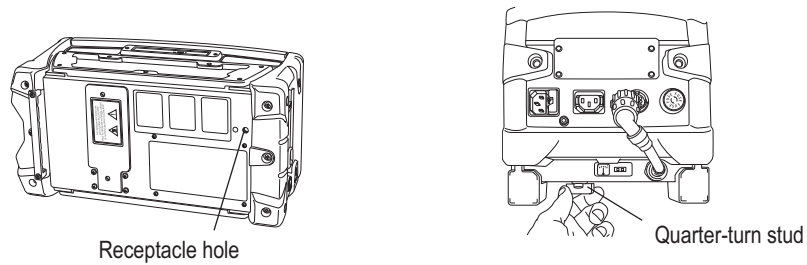


To Install a Battery

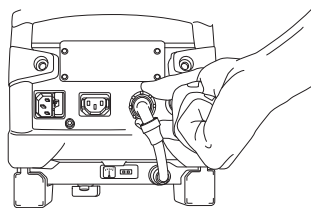
1. If not already installed, install the battery bracket. Use the provided screws.
2. Slide the battery tabs into the bracket slots.



3. Align the quarter-turn stud with the receptacle hole in the base unit. Press the battery to the base unit. Turn the stud clockwise.



4. Plug in the DC power connector.



To Charge the Battery

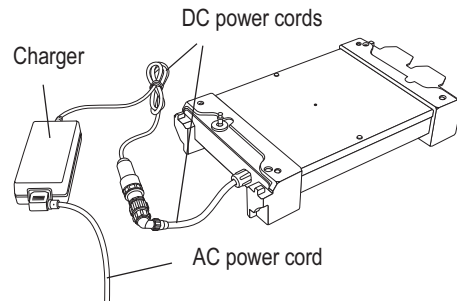
1. Connect to power in one of these ways:

- **Battery installed**

If the battery is installed in the base unit, plug the base unit into AC power. The battery charges whether the system is on or off.

- **Battery removed**

If the battery is removed from the base unit, connect the charger's DC power cord to the battery's DC power cord. Then plug one end of the AC power cord into the charger and the other end into the AC outlet.



2. Wait for the battery to charge.

The battery's green LED flashes for a few seconds. Then it lights up solid and stays lit until the charge is complete. When the charge is complete, the green LED shuts off.

A fully discharged one-hour battery takes about four hours to charge.

A fully discharged two-hour battery takes about eight hours to charge.

If the red LED lights up during this process, contact GE Inspection Technologies.

Replacing the Internal Memory Card

The internal memory card contains the operating system software as well as your image and video files. You might want to replace the memory card, for example, to increase storage capacity.

Only qualified electrical technicians should replace this card. This card is not user serviceable.

To Replace the Internal Memory Card

1. Turn off all sources of power.

Turn off the power switch. Unplug AC power cord from power source. If a battery is installed, unplug the DC power connector.

2. Unscrew and remove the access panel.

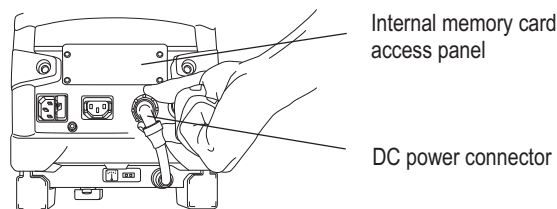
3. Eject the memory card.

Use a pen to push the button to the left of the drive.

4. Slide the new card into the drive. Push in gently to seat the card.

5. Reinstall the access panel.

6. Turn the system back on. Confirm that it starts correctly.



9 Troubleshooting

Image	127
Probe	128
Power	128
Lamp	128
Software	129

For measurement, see “[Troubleshooting Measurements](#)” on page 113.

Image

Condition	Causes	Actions
Images are distorted or blurred within normal range.	<ul style="list-style-type: none"> Optical tip is not threaded onto the camera head securely. The optical surfaces are dirty. 	<ul style="list-style-type: none"> Reinstall the optical tip. See “To Attach an Optical Tip” on page 31. Clean the optical tip and the camera head. See “To Inspect and Clean an Optical Tip” on page 115 and “To Inspect and Clean a Probe” on page 116.
Image quality is otherwise poor.	Various	<ul style="list-style-type: none"> Verify that the QuickChange probe is properly seated and latched. See “To Install a Probe” on page 30. Clean the optical tip and camera head. See “To Inspect and Clean an Optical Tip” on page 115 and “To Inspect and Clean a Probe” on page 116. If the problem occurs in DC operation, check battery’s charge and its compliance with listed specifications. For an illustration of the battery charge indicators, see “Maintaining the Battery” on page 122. Verify that the lamp has been installed properly. See “To Install a Lamp” on page 119.
No image appears in the display. (Green LED on the power switch is lit.)	Various	<ul style="list-style-type: none"> Verify that the probe is properly seated and latched. See “To Install a Probe” on page 30. Point the probe tip toward a bright light and see if image appears. If image appears, the problem is associated with lamp operation. If still no image, contact GE Inspection Technologies. If an external monitor is available, determine whether an image appears on it. Connect the monitor’s VIDEO IN (or S-VIDEO IN) to the base unit’s VIDEO OUT (or S-VIDEO OUT) connector. Verify the image.
Frozen image “jitters.”	Probe tip was moving when image was captured.	Unfreeze then refreeze the image, keeping probe tip steady.

Probe

Condition	Causes	Actions
Reduced articulation in the bending neck.	Various	<ul style="list-style-type: none"> Whenever using the system, minimize bends throughout the entire length of the insertion tube, including the end nearest to the handset. Unnecessary bending can reduce articulation. Redistribute the lubricant inside the insertion tube as follows. Straighten the insertion tube to its full length, with Person A holding it near where it joins the handset (to stabilize the probe), and Person B holding it just before the bending neck (to prevent damaging the bending neck). Have Person B shake the entire tube. CAUTION: Do not pull on the probe tip or the bending neck while shaking the tube. The mechanical cables could break.
Bending neck is not articulating.	System is in a mode that disables articulation: Steer-and-Stay, freeze frame, menu, or desktop.	<ul style="list-style-type: none"> Exit any mode the system may be in. Turn power switch off. Leave the system off for at least 15 seconds so that it can complete its shutdown sequence. Then turn it back on.
Insertion tube does not freely withdraw from the storage reel.	Tube is obstructed.	Remove the funnel. Clear any obstruction or binding. For an illustration of removing the funnel, see "To Clean the Insertion Tube Storage Reel" on page 117.

Power

Condition	Causes	Actions
When plugged into AC power, system won't turn on. (Power switch is on, but its green LED is not lit.)	<ul style="list-style-type: none"> Power interruption. Faulty AC power connection. Blown AC fuses. No AC power. 	<ul style="list-style-type: none"> Leave the system off for at least 15 seconds so that it can complete its shutdown sequence. Then turn it back on. Check the power cable connections. Check the AC power source. Check the AC fuses. See "To Check or Replace the AC Fuses" on page 120.
When unplugged from AC power, system won't turn on. (Power switch is on, but its green LED is not lit.)	<ul style="list-style-type: none"> Battery disconnected or incorrectly connected. Battery low, not charging, depleted, or bad. Blown battery fuse. 	<ul style="list-style-type: none"> Leave the system off for at least 15 seconds so that it can complete its shutdown sequence. Then turn it back on. Check battery's connections. See "To Remove the Battery" and "To Install a Battery" on page 123. Check battery's charge level. See "To Check the Battery's Charge Level" on page 122. Check the battery's compliance to listed specifications. Recharge or replace the battery. See "Maintaining the Battery" on page 122. Replace battery fuse. See "To Check or Replace the Battery (DC) Fuse" on page 121.

Lamp

Condition	Causes	Actions
Lamp does not come on when you turn on power switch. (Green LED on the power switch is lit.)	Various	See "To Determine Whether to Replace the Lamp" on page 118.

Software

Condition	Causes	Actions
Time, date, or other settings are lost when system is turned off.	Internal battery needs replacing. (Normal life is five to seven years.)	Return system to GE Inspection Technologies to have internal battery replaced.

DVD Recording

Condition	Causes	Actions
The XLG3 will not record to the DVD.	You are not using validated media.	<ul style="list-style-type: none"> The XLG3 has been tested to work with only DVD-R and DVD+R media. At the time of publication of this manual, only Sony and Verbatim brands of DVD media have been validated. (Contact GEIT RVI technical support for the latest listing of validated media and accessories.)

Storing Data to USB Thumb Drive

Condition	Causes	Actions
The XLG3 will not record to a USB thumb drive.	<ul style="list-style-type: none"> You are not using a validated USB thumb drive. The USB thumb drive contains "U3" software files. This "U3" software can cause read/write errors on the XLG3. 	<ul style="list-style-type: none"> At the time of publication of this manual, only specific brands of USB thumb drive have been validated. (Contact GEIT RVI technical support for the latest listing of validated media and accessories.) Sandisk (an approved USB thumb drive) has recently begun including "U3" utility software on the thumb drive. The "U3" software must be uninstalled on a PC before the thumb drive can be used with the XLG3. An uninstall program can be downloaded from Sandisk: http://u3uninstall.s3.amazonaws.com/U3Uninstall.exe

A Specifications

Feature	Specification
Power	
AC	100 – 240 V, 50 – 60 Hz; 115 V, 400 Hz
DC (optional battery)	11 – 16 V
Maximum consumption	300 W
Nominal consumption	150 W (when not charging battery or using accessories)
Battery operation	Up to one hour (small battery) or two hours (large battery)
AC output	IEC-type F connector. The voltage and frequency of the power available at the AC output is the same as the voltage and frequency applied to the inlet. Maximum output is 100 W.
Arc lamp	75-watts, high-intensity discharge (HID)
Fuses	
AC	:6.3A, 250V, fast acting
DC	20A, 600 VDC, fast acting
Operating environment	
System operating temperature	-4° to 115°F (-20° to 46°C) LCD requires warm-up period below 32°F (0°C) .
Tip operating temperature	-13° to 176°F (-25° to 80°C) Reduced articulation below 32°F (0°C)
Storage temperature	-13° to 140°F (-25° to 60°C)
Relative humidity	95% max, non condensing
Waterproof:	Insertion tubes are watertight to 1 bar (14.5 psig, 10.2 m [33.5 ft] of H ₂ O)
Hazardous Environments	Not rated for use in hazardous environments
System	
Case Dimensions	Standard: 54.6 x 49.5 x 32.0 cm (21.5 x 19.5 x 12.6 in) Tall: 54.6 x 60.9 x 32.0 cm (21.5 x 24 x 12.6 in)
Weight	In Case: 21.8 kg (48 lb) Without Case: 10.9 kg (24 lb)
QuickChange™ Probes	
6.1 mm (0.242 in), 5.0 mm (0.197 in) and 8.4 mm (0.331 in) Diameter Probes	
Image Sensor	1/6" Color SUPER HAD CCD®
Pixel Count	440,000 pixels
Temperature Sensor	Integrated Temperature Warning System

Feature (cont.)	Specification (cont.)
Camera Housing	Titanium
Articulation	360° All-Way®
Tip Optics	Double threaded attachment
3.9 mm (0.154 in) Diameter Probes	
Image Sensor	1/10" Color, SUPER HAD CCD
Pixel Count:	290,000 pixels
Camera Housing	Titanium
Articulation	360°
All-Way Tip Optics	Double threaded attachment
Handset	
Dimensions	39 x 18 x 13 cm (15.4 x 7.1 x 5.1 in)
Weight	1.81 kg (3.98 lb)
Construction	Polycarbonate housing with integrated elastomer bumpers
LCD	16.3 cm (6.4 in) diagonal, 16 x 9 aspect ratio, 800 x 480 pixels, wide VGA
LCD Brightness	380 nits (cd/m ²)
Power Tube	2.4 m (8 ft) long
User Controls	Joystick and complete button function set
Microphone	Built-in microphone for audio annotation located at the top center of the handset
Base Unit	
Dimensions	44 x 22 x 35 cm (17.3 x 8.7 x 13.8 in)
Weight	7.21 kg (15.90 lb)
Construction	Aluminum chassis with polyurethane bumpers
System CPU	Intel Pentium® M
Video Processors	Multiple digital signal processors
Brightness Control	Automatic and variable, adjustable auto gain and exposure
System Memory	Internal CompactFlash® card, 2.7GB (standard)
Lamp Type	75W High Intensity Discharge (HID)
Lamp Output	4300 Lumens
Lamp Life	1000 hour median
Keyboard Input:	USB keyboard with built-in trackball
Video Outputs	Switchable NTSC/PAL S-Video, Standard 15-pin PC video connector
Video Input	Auto detecting NTSC/PAL S-Video
USB	Three external USB 2.0 ports
Ethernet	Integrated 10/100 Ethernet port
CompactFlash	One CompactFlash card (Type II) slot
AC Input	AC Nominal input: 100 to 240 V, 50 to 60 Hz; 115 V, 400 Hz; 275 W max
AC Output	100 W max; IEC320-2-2 Type F connector
DC Input	11 to 15 VDC; nominal 12 VDC; 150 W max

Feature (cont.)	Specification (cont.)
Audio Output Connectors	Built-in front panel speaker, 3.5 mm stereo line level out, 2V RMS max, 3.5 mm stereo headphone
Audio Input Connector	3.5 mm microphone
Software	
Operating System	Multitasking with desktop software options
User Interface	Drop-down menu driven operation, joystick, and keypad
File Manager	File and folder creation, naming, copying and deleting
Measurements	StereoProbe®, ShadowProbe® and Comparison
MDI Software (optional)	Provides user defined guided inspection. Creates DICONDE compatible inspection files Creates MS Word™ compatible inspection reports
Audio Data	PC compatible, 15 second files (WAV or MP3 format). PCM audio with MPEG2 video recordings
Image Controls	Adjustable brightness, 1/10,000 sec to 12 sec exposure. Left/Right invert for side-view tip correction. Freeze frame, live/still Inverse+ enhancement, side-by-side split screen
Digital Zoom	1X to 3X – Continuous and 5-level stepped
User Available Memory	2.7GB internal, user-supplied external
Annotation	Text and arrow overlays and custom logos
Articulation Controls	360° All-Way® steering, Steer-and-Stay™, Home
Lamp Control	On/Off, menu-controlled
Software Updates	Field upgradeable via removable media
Temperature Warning	Integrated camera and base unit temperature warning systems
DVD writing	DVD+R, DVD-R, still images, audio clips, MPEG2 video and PCM audio real-time recording
Languages	Chinese, Czech, English, French, Japanese, Spanish, Russian, German, Italian, Portuguese, Swedish, or factory supplied custom language.
Tip Articulation	2.0 m, 3.0 m, and 4.5 m Up/Down – 140° min, Left/Right – 140° min 6.0 m Up/Down – 130° min, Left/Right – 130° min 8.0 m Up/Down – 120° min, Left/Right – 120° min 9.6 m Up/Down – 110° min, Left/Right – 110° min Note: Typical articulation exceeds minimum specifications

B Agency Certifications

European Equipment Classification

Group 1, Class A

The **CE** mark on this product indicates it has been tested to and conforms with the provisions noted within the 2004/108/EC Electromagnetic Compatibility Directive. The XLG3 system is in conformance with the following standards: 2004/108/EEC.

Declarations of Conformity are held by GE Inspection Technologies GmbH:

GE Inspection Technologies GmbH
Product Service Center
Lotzenäcker 4
72739 Hechingen Germany
Tel: +49(0) 74719882 0
Fax: +49(0) 74719882 16

Safety Mark

The XLG3 system is in compliance with the following standards: UL61010-1 and CSA-C22.2 No. 61010-1.

Intrinsic Safety

The XLG3 system is not rated for intrinsically safe operation.

FCC Compliance

This device complies with part 15 of the FCC rules. Operation is subject to the following two conditions:

1. This device may not cause harmful interference.
2. This device must accept any interference received, including interference that may cause undesired operation.

FCC Class A Compliance Statement

This equipment has been tested and found to comply with the limits for a Class A digital device pursuant to part 15 of the FCC rules. These limits are designed to provide reasonable protection against harmful interference in a residential installation. This equipment generates, uses, and can radiate radio frequency energy and, if not installed and used in accordance with the instructions, may cause harmful interference to radio communications. However, there is no guarantee that interference will not occur in a particular installation.

If this equipment does cause harmful interference to radio or television reception, which can be determined by turning the equipment off and on, the user is encouraged to try to correct the interference by one or more of the following measures:

- Reorient or relocate the receiving antenna.
- Increase the separation between the equipment and receiver.
- Connect the equipment into an outlet on a circuit different from that to which the receiver is connected.

Caution: Any changes or modifications made to this device that are not expressly approved by GE Inspection Technologies may void the user's authority to operate the equipment.

To maintain compliance with FCC rules and regulations, cables connected to this device must be *shielded* cables, in which the cable shield wire(s) have been grounded (tied) to the connector shell.

Canadian Notice

This equipment does not exceed the Class A limits for radio noise emissions as described in the Radio Interference Regulations of the Canadian Department of Communications.

Le present appareil numerique n'emet pas de bruits radioelectriques depassant les limites applicables aux appareils numeriques de la classe A prescrites dans le Reglement sur le brouillage radioelectrique edicte par le ministere des Communications du Canada.

C Chemical Compatibility

Chemical compatibility refers to the probe's ability to come into contact with various liquid substances and not be damaged. There are far too many different liquids in the industrial environment for GE Inspection Technologies to test each one, so customers must determine for themselves whether the probe is compatible with their specific chemicals.

However, GE Inspection Technologies has tested the probe to several of the more common substances and reports the results in the hope that it might be of assistance.

Whatever the liquid, duration of exposure should be minimized and the probe cleaned after each use before storage.



WARNING POSSIBLE EXPLOSION HAZARD. Do not use this system in explosive environments.

These substances have no affect on the probe:

Water	Synthetic Turbo Oil
Aircraft Gasoline	Gasoline
Jet-A-Fuel	Diesel Fuel
Isopropyl alcohol	Hydraulic Oil
JP-4 Fuel	Inhibited Transformer Oil
Kerosene	

In general, if a liquid is relatively clear and safe for your hand, it is probably safe for the probe. If it is not safe for your hand, it is probably not safe for the probe.

D

Warranty



GE Inspection Technologies warrants its VideoProbe components, when new, to be free from defects in material and workmanship and to perform in accordance with manufacturer's specifications under normal use and service for a period of one year from the date of purchase from GE Inspection Technologies or its authorized distributors, except that, where used, servo motors in the articulation drive system are warranted for the life of this VideoProbe product.

GE Inspection Technologies' obligation under this warranty is limited to the repair or replacement of components determined by GE Inspection Technologies to be defective within the warranty period at no cost to the original purchaser, except for return shipping expenses. It shall be the purchaser's responsibility to return the product to GE Inspection Technologies or one of its authorized service centers. The warranty does not cover lamps, accessories, or optional equipment not manufactured by GE Inspection Technologies, but these items may be covered by separate manufacturers' warranties. This warranty extends to the original purchaser and cannot be assigned or transferred to any third party.

This warranty shall not apply to any damage or product failure determined by GE Inspection Technologies to have been caused by misuse, accident (including shipping damage), neglect, improper maintenance, modification or repair by someone other than GE Inspection Technologies or one of its authorized service representatives.

These express warranties are in lieu of any other warranties, express or implied, including the warranties of merchantability and fitness for a particular purpose, and no other person has been authorized to assume for GE Inspection Technologies any other liability in connection with the sale of its VideoProbe products. GE Inspection Technologies shall not be liable for any loss or damages, whether direct or indirect, incidental, or consequential, resulting from the breach of any express warranty set forth herein.

E Menu Trees

Menu	How to Access
Main Menu: Live, page 141 Freeze Frame, page 142 Split Screen, page 142 Recalled Image, page 143 Recalled Video, page 143	Press  . The menu that appears depends on the type of image displayed.
Shared Menu: File Manager, page 144 Setup, page 144 Video Record, page 145 Video Recording Options, page 145 Save, page 146	Press  . Then select the desired menu.

Live Menu

Live image is displayed.

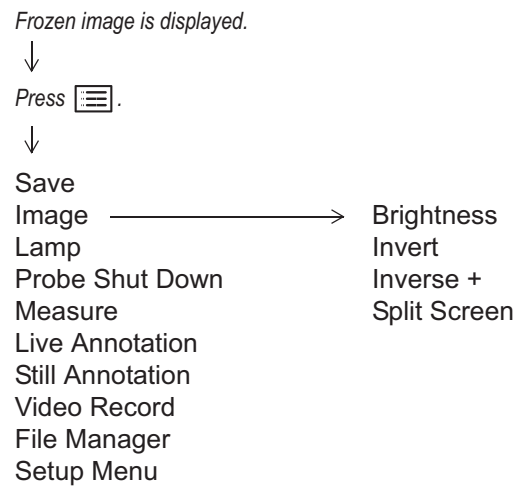


Press .

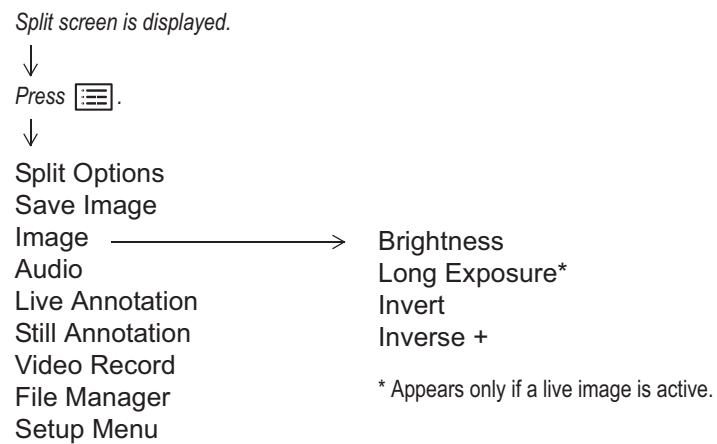


Image	→	Brightness
Menu Directed Inspection		Adaptive Noise Reduction
Lamp		Distortion Correction
Probe Shut Down		Long Exposure
Live Annotation		Invert
Video Record		Inverse +
Desktop		Single View
Flashlight		Split Screen
File Manager		
Setup Menu		

Freeze Frame Menu



Split Screen Menu



Recalled Image Menu

Recalled image is displayed.



Press .



Save Image	→	Brightness
Image		Invert
Rename Image		Inverse +
Live Annotation		Split Screen
Still Annotation		Depth Map
Measure		Point Cloud
Audio		
Video Record		
File Manager		
Setup Menu		

Recalled Video Menu

Recalled video is playing.



Press . Playback pauses.



Play	→	Start Over
Rename		Continue
Save Still Image		
File Manager		

File Manager Menu

Any type of image is displayed.



Press . Select **File Manager**. Then select **File Manager** again.




Recall	→	Internal Drive
Copy		External CF Card
Delete		
Folder		
Archive		
Eject Hardware		

Setup Menu

Any type of image is displayed.



Press . Select **Setup**.



Still Save		
Save Format		
JPEG Quality		
Graphics		
Text Color		
Logo		
Measure		
System	→	
Temp Sensor		
Battery		
White Balance		
Audio		
Communications	→	
		Unit Name
		IP Address
		Remote File Access
		Remote Handset Control
		Relink Now
		Wireless Configuration
		Video Streaming
		System Info
		Language
		Keyboard
		Time/Date
		Steering
		Distortion Values - Load
		MDI-Energy Advanced
		Menu Directed Inspection
		Feature Update
		Video Output Format
		LCD Display

Video Record Menu

Any type of image is displayed.



Press . Select **Video Record**.



Start Recording
Resume Recording
Stop
Pause
DVD Initialize
Recording Options



Only the items that apply to your task will appear.

Video Recording Options Menu

Any type of image is displayed.



Press  quickly.

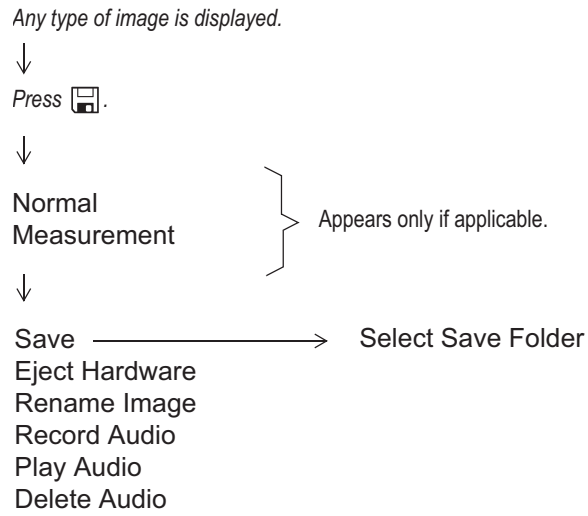
- or -

Press . Select **Video Record > Recording Options**.




































Start Recording
Cancel
MPEG Quality
Mic
Select Drives
Select Save Folder
Name Video













Save Menu



F Optical Tips

Tip	Diameter (mm)	View (DOV)	Color	Field of View (FOV) ^a	Depth of Field (DOF)	Part Number
Standard Optical Tips						
	3.9	Forward	None	80	6 – 80 mm 0.24 – 3.15 in.	PXT480FG
	3.9	Side	Brown	80	4 – 80 mm 0.16 – 3.15 in.	PXT480SG
	5.0	Forward	None	50	50 mm – infinity 1.97 in. – infinity	PXT550FF
	5.0	Forward	White	50	12 – 200 mm 0.47 – 7.87 in.	PXT550FG
	5.0	Forward	Orange	80	3 – 20 mm 0.12 – 0.79 in.	PXT580FN
	5.0	Forward	Black	100	5 – 120 mm 0.20 – 4.72 in.	PXT5100FG
	5.0	Side	Green	50	9 – 160 mm 0.35 – 6.30 in.	PXT550SG
	5.0	Side	Red	80	1 – 20 mm 0.04 – 0.79 in.	PXT580SN
	5.0	Side	Blue	100	4 – 100 mm 0.16 – 3.94 in.	PXT5100SG
	6.1	Forward	None	50	50 mm – infinity 1.97 in. – infinity	XLG3T6150FF
	6.1	Forward	White	50	12 – 200 mm 0.47 – 7.87 in.	XLG3T6150FG
	6.1	Forward	Orange	80	3 – 20 mm 0.12 – 0.79 in.	XLG3T6180FN
	6.1	Forward	Yellow	90	20 mm – infinity 0.79 in. – infinity	XLG3T6190FF
	6.1	Forward	Black	120 ^b	5 – 120 mm 0.20 – 4.72 in.	XLG3T61120FG
	6.1	Forward Oblique	Purple	50	12 – 80 mm 0.50 – 3.2 in.	XLG3T6150FB

Tip	Diameter (mm)	View (DOV)	Color	Field of View (FOV) ^a	Depth of Field (DOF)	Part Number
Standard Optical Tips (continued)						
	6.1	Side	Brown	50	45 mm – infinity 1.77 in. – infinity	XLG3T6150SF
	6.1	Side	Green	50	9 – 160 mm 0.35 – 6.30 in.	XLG3T6150SG
	6.1	Side	Red	80	1 – 20 mm 0.04 – 0.79 in.	XLG3T6180SN
	6.1	Side	Blue	120 ^b	4 – 100 mm 0.16 – 3.94 in.	XLG3T61120SG
	6.2	Forward	None	40	100 mm – infinity 3.94 in. – infinity	PXT6240FF
	6.2	Forward	Yellow	120 ^c	35 mm – infinity 1.38 in. – infinity	PXT62120FF
	6.2	Forward	Black	120 ^c	4 – 190 mm 0.16 – 7.48 in.	PXT62120FN
	6.2	Side	Green	80	18 mm – infinity 0.71 in. – infinity	PXT6280SF
	6.2	Side	Blue	120 ^c	5 mm – infinity 0.20 in. – infinity	PXT62120SN
	8.4	Forward	Gold	20	500 mm – infinity 19.69 in. – infinity	XLG3T8420FF
	8.4	Forward	None	40	250 mm – infinity 9.84 in. – infinity	XLG3T8440FF ^c
	8.4	Forward	Yellow	80	25 – 500 mm 0.98 – 19.69 in.	XLG3T8480FG
	8.4	Forward	Black	120 ^c	5 – 200 mm 0.20 – 7.87 in.	XLG3T84120FN
	8.4	Side	Brown	40	250 mm – infinity 9.84 in. – infinity	XLG3T8440SF ^c
	8.4	Side	Green	80	25 – 500 mm 0.98 – 19.69 in.	XLG3T8480SG
	8.4	Side	Blue	120 ^c	5 – 200 mm 0.16 – 7.87 in.	XLG3T84120SN
3D Phase Measurement Optical Tips						
	6.1	Forward	Black	105	8 – 250 mm 0.31 – 9.84 in.	XL4TM61105FG
	6.1	Side	Blue	105	7 – 250 mm 0.27 – 9.84 in.	XL4TM61105SG

Tip	Diameter (mm)	View (DOV)	Color	Field of View (FOV) ^a	Depth of Field (DOF)	Part Number
ShadowProbe Measurement Optical Tips						
	6.1	Forward	White	50	12 – 30 mm 0.47 – 1.18 in.	XLG3TM6150FG
	6.1	Side	Blue	50	7 – 24 mm 0.28 – 0.94 in.	XLG3TM6150SG
StereoProbe Measurement Optical Tips						
	3.9	Forward	Black	50/50	5 – 45 mm 0.20 – 1.77 in.	PXTM45050FG
	3.9	Side	Blue	50/50	4 – 45 mm 0.16 – 1.77 in.	PXTM45050SG
	5.0	Forward	Black	60/60	4 – 80 mm 0.16 – 3.15 in.	PXTM56060FG
	5.0	Side	Blue	45/45	2 – 50 mm 0.08 – 1.97 in.	PXTM54545SG
	6.1	Forward	Black	60/60	4 – 80 mm 0.16 – 3.15 in.	XLG3TM616060FG
	6.1	Side	Blue	50/50	2 – 50 mm 0.08 – 1.97 in.	XLG3TM615050SG
	6.2	Forward	Black	60/60	4 – 80 mm 0.16 – 3.15 in.	PXTM626060FG
	6.2	Side	White	60/60	2 – 50 mm 0.08 – 1.97 in.	PXTM626060SG
	8.4	Forward	Black	60/60	4 – 50 mm 0.16 – 1.97 in.	XLG3TM846060FG
	8.4	Side	Blue	60/60	4 – 50 mm 0.16 – 1.97 in.	XLG3TM846060SG

a. FOV is specified diagonally.

b. Indicates tips with maximum brightness

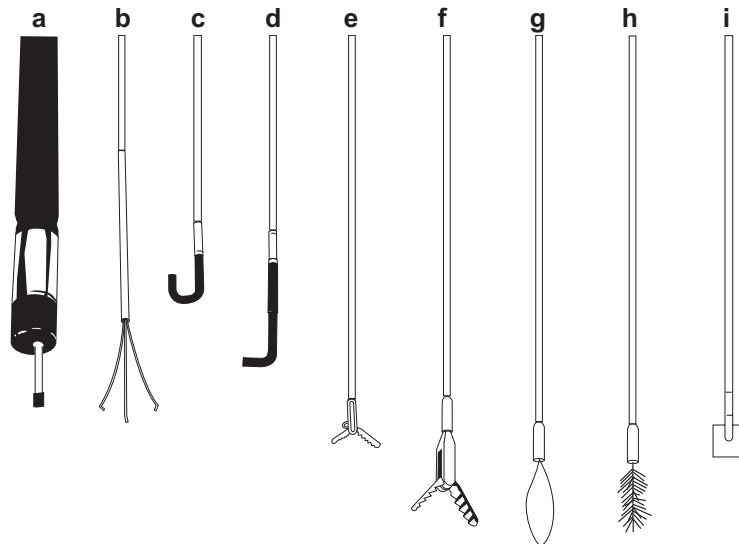
c. Distortion correction is available for 120° tips. For details, see [“Correcting Wide-Angle Distortion”](#) on page 56.

6.2mm Internal Working Channel Feature

The internal working channel is available in the 6.2mm tip models. This channel has a 1.6mm ID and allows the use of micro-tools together with forward-viewing optical tips to perform a number of measurement and retrieval tasks.

The tools are designed to be installed from a specified end of the probe, depending on the particular tool. The following interchangeable tools, as shown below, are available for 6.2mm probes:

- a. 4mm and 8mm magnetic retrieval tools
- b. 3-prong gripper
- c. hook tool
- d. 0.055 inch comparator gauge
- e. small alligator
- f. large alligator
- g. loop/snare
- h. brush
- i. shim



G Environmental Compliance



The equipment that you bought has required the extraction and use of natural resources for its production. It may contain hazardous substances that could impact health and the environment.

In order to avoid the dissemination of those substances in our environment and to diminish the pressure on the natural resources, we encourage you to use the appropriate take-back systems. Those systems will reuse or recycle most of the materials of your end-life equipment in a sound way.

The cross-out wheeled bin symbol invites you to use those systems.

If you need more information on the collection, reuse, and recycling systems, please contact your local or regional waste administration.

Visit www.ge.com/inspectiontechnologies for take-back instructions and more information about this initiative.



EU Battery Directive

This product contains a battery that cannot be disposed of as unsorted municipal waste in the European Union. See the product documentation for specific battery information. The battery is marked with this symbol, which may include lettering to indicate cadmium (Cd), lead (Pb), or mercury (Hg). For proper recycling return the battery to your supplier or to a designated collection point.

What do the markings mean?

Batteries and accumulators must be marked (either on the battery or accumulator or on its packaging, depending on size) with the separate collection symbol. In addition, the marking must include the chemical symbols of specific levels of toxic metals as follows:

Cadmium (Cd) over 0.002%

Lead (Pb) over 0.004%

Mercury (Hg) over 0.0005%

The risks and your role in reducing them

Your participation is an important part of the effort to minimize the impact of batteries and accumulators on the environment and on human health. For proper recycling you can return this product or the batteries or accumulators it contains to your supplier or to a designated collection point. Some batteries or accumulators contain toxic metals that pose serious risks to human health and to the environment. When required, the product marking includes chemical symbols that indicate the presence toxic metals: Pb for lead, Hg for mercury, and Cd for cadmium. Cadmium poisoning can result in cancer of the lungs and prostate gland. Chronic effects include kidney damage, pulmonary emphysema, and bone diseases such as osteomalacia and osteoporosis. Cadmium may also cause anemia,

discoloration of the teeth, and loss of smell (anosmia). Lead is poisonous in all forms. It accumulates in the body, so each exposure is significant. Ingestion and inhalation of lead can cause severe damage to human health. Risks include brain damage, convulsions, malnutrition, and sterility. Mercury creates hazardous vapors at room temperature. Exposure to high concentrations of mercury vapor can cause a variety of severe symptoms. Risks include chronic inflammation of mouth and gums, personality change, nervousness, fever, and rashes.

Visit www.ge.com/inspectiontechnologies for take-back instructions and more information about this initiative.

Index

120-degree distortion correction, 56
 3D phase measurements, 91
 4x3 display setting, 44

A

accuracy index, 43, 90
 AC. *See* power
 adaptive noise reduction (ANR), 4, 54
 agency certifications, 135
 alcohol, probe's compatibility with, 137
 annotations, 60–63
 See also audio comments, 60
 ANR (adaptive noise reduction), 4, 54
 archiving files to a DVD, 77
 area measurements, 95, 103, 109
 arrows. *See* annotations
 audio comments
 about, 47, 48, 79
 adding to images, 61, 66
 icon, 73
 audio files, 40, 41, 79
 audio output
 connector, 10, 11
 settings, 39

B

backup drive for video recording, 69
 base unit, 10–13
 battery
 See also power
 about, 4
 maintenance, 122–124
 bending neck
 holding in place (Steer-and-Stay), 49
 illustration, 9
 straightening (Home), 32, 49
 troubleshooting, 128
 bitmaps (BMP files). *See* images (still)
 brightness, adjusting, 53, 54
 browser, 5, 78, 79
 buttons, control, 8, 15, 78

C

calibration
 measurement tips, 43, 89
 measurement verification block, 112
 camera (external), connector for, 10
 camera head
 about, 2, 9
 aiming, 49
 cleaning, 116
 case, system storage, 14
 “caution,” definition of, 17
 See also safety
 certifications, 135
 chemical compatibility, 137
 circle gauge measurements, 109
 cleaning and inspecting, 115–117
 color, text, 42
 comments. *See* audio comments
 communications, 5
 comparison measurements. *See* measuring features and defects
 components of system, 7–14
 configuration. *See* set up
 contact information, iii
 control buttons. *See* buttons, control
 copying files, 75, 77
 customer service, iii

D

date and time settings, 44, 129
 DC. *See* battery or power
 defaults
 file names, 66, 71
 white balance settings, 119
 deleting files, 76
 deleting folders, 75
 depth measurements, 94, 102, 108
 depth of field, 147
 desktop, 5, 78–79
 display size, 44
 distance (length) measurements, 94, 102, 108
 distortion correction, 4, 56

dust filter, 29, 116

DVDs

- about, 68
- archiving files to, 77
- drive location, 11
- ejecting, 74
- initializing, 68
- recording video to, 69
- storage capacity, 41

E

- ejecting storage devices, 32, 74
- e-mail, 5
- energized equipment, 23, 25
- environmental compliance, 151
- Ethernet connections, 10, 34
- exposure time, 57
- extension cords, 23
- external devices, connectors for, 10

F

- fast-forwarding videos, 72
- FCC compliance, 136
- Feature Update, 44, 144
- field of view, 147
- file management, 73–86
 - See also* “save” folders
- File Manager menu, 144
- file names, default, 66, 71
 - See also* naming and renaming
- file sharing. *See* PC communications
- file sizes, typical, 40, 41
- filter. *See* dust filter
- Firefox. *See* browser
- flashlight LEDs, 7, 29
- FMV (full-motion video) files, 41
- folders and files. *See* file management
- formats, image, 40
- Freeze Frame menu, 142
- freezing an image, 50
- frequent tasks, 3
- “full” display setting, 44
- funnel
 - about, 12, 13
 - inserting and removing insertion tube, 28, 32
 - removing and cleaning, 117
- fuses
 - See also* power
 - checking and replacing, 120–121
 - specifications, 131

G

- gasoline, probe's compatibility with, 137
- grippers, 49
- grounding, 23–25

H

- handset
 - components of, 7, 8
 - inspecting and cleaning, 117
 - using with holder, 28, 29, 32
- handset cable
 - about, 7, 13
 - unwrapping and wrapping, 28, 33
- hardware. *See* set up
- headset connector, 11
- help, getting, 1
- Home function, 32, 49
- humidity, relative, 131

I

- image processing package (optional), 4
- images (still)
 - capturing, 47–66
 - managing, 73–86
 - selecting format and quality of, 40
 - troubleshooting, 127
 - viewing in other applications, 87
- importing files. *See* PC communications
- initializing. *See* DVDs
- insertion tube
 - See also* probe
 - about, 9
 - caring for, 18, 19, 116
 - guiding, 49
 - inserting and removing from funnel, 28, 32
- inspection and cleaning, 115–117
- installation. *See* set up
- internal drive (memory card)
 - about, 12
 - checking available memory, 44
 - replacing, 125
 - storage capacity, 40, 41
- internal working channel, 150
- Internet access, 5, 78, 79
- Inverse +, 58
- inverter, vehicle, 24
- inverting an image, 59
- IP address, 45, 82

J

joystick
 about, 8
 for aiming the camera, 49
 for navigating menus, 15
 for navigating the desktop, 78
 for panning a zoomed image, 44, 50
 JPEGs. *See* images (still)

K

kerosene, probe's compatibility with, 137
 keyboard, USB, 10
 keyboard, virtual, 78
 See also text-entry screen
 keys. *See* buttons, control

L

lamp
 about, 2, 13
 replacing, 118
 troubleshooting, 128
 turning on and off, 29
 warnings, 18
 languages, 44
 LCD display size, 44
 length (distance) measurements, 94, 102, 108
 liquids, probe's compatibility with, 137
 live annotations. *See* annotations
 Live menu, 141
 logo use, 42
 long exposures, 57

M

maintenance, 115–125
 matching cursors, 97
 measuring features and defects
 3D phase measurements, 91
 about, 87–90
 comparison measurements, 88, 110–111
 measurement files, 65–66, 73
 measurement settings, 43
 measurement tips, 89, 112, 148, 149
 at a PC, 34
 phase measurements, 88, ??–95
 shadow measurements, 88, 104–109
 stereo measurements, 88, 96–103
 troubleshooting, 113
 memory, internal. *See* internal drive
 memory sticks (cards). *See* removable storage devices
 Menu Directed Inspection

 About, 6
 menus
 menu trees, 141–146
 navigating (example), 15
 microphone
 external, 10, 11
 location, 7
 turning on and off, 39
 mouse, USB, 10
 MPEG quality, 41, 69
 multi-segment line (length) measurements, 95, 103, 109

N

name of unit (device), 45
 naming and renaming
 See also desktop
 folders, 75
 images, 66
 videos, 69, 71
 navigating the menus, 15
 negative effect (Inverse +), 58
 network package (optional), 5
 "noise" reduction, 4, 54
 normal (nonmeasurement) images, 65
 NTSC setting, 44

O

oil, probe's compatibility with, 137
 operating temperature, 131
 optical tips, 9
 inspecting and cleaning, 115
 removing and installing, 28, 31, 32
 types of, 147–??
 overheating. *See* ventilation

P

PAL setting, 44
 panning a zoomed image, 44, 50
 pausing a video
 when playing back, 72
 when recording, 70
 PC cards. *See* removable storage devices
 PC communications
 as part of network package, 5
 connecting to a PC or network, 34
 reviewing settings, 45
 sharing files, 80–86
 PDF files, viewing, 78
 peripheral devices, connectors for, 10
 phone numbers, iii
 playing a video, 72

point cloud view, 92
 point-to-line measurements, 94, 102, 108
 power
 See also fuses
 grounding, 23–25
 specifications, 131
 troubleshooting, 128
 probe
 See also insertion tube
 about, 2, 9
 available sizes, 9
 inspecting and cleaning, 116
 removing and installing, 30
 problem-solving. *See* troubleshooting
 profile measurements, 95
 Preview. *See* Inverse +

Q

quality settings
 for JPEGs, 40
 for videos, 41, 69
 QuickChange. *See* probe

R

reading files. *See* PC communications
 recalling files
 images, 51, 75, 143
 videos, 72, 75, 143
 recording. *See* video files
 recycling, 151
 relative humidity, 131
 relinking to a network, 45
 remote access. *See* PC communications
 remote control (handheld), 2, 8
 removable storage devices
 drives for, 10
 PC card slot considerations when recording video, 69
 storage capacities of, 40, 41
 working with, 74
 renaming. *See* naming and renaming
 repairs, iii
 rewinding videos, 72
 rigidizers, 33, 49

S

safety
 certifications, 135
 general warnings and cautions, 17–22
 grounding, 23–25
 “save” folders, selecting, 66, 69
 “save” formats for images, 40

Save menu, 146
 saving (still) images, 65–66
 service centers, iii
 set up
 hardware, 27–33
 software, 39–45
 Setup menu, 144
 ShadowProbe. *See* measuring features and defects
 sharing files. *See* PC communications
 shoulder strap, 7, 12, 13
 Single View, 99
 skew measurements, 108
 software, updating, 44
 software. *See* set up
 sound. *See* audio or volume control
 speakers, 10, 11
 specifications, 131
 split screen, 52
 Split Screen menu, 142
 steering the probe, 44, 49
 StereoProbe. *See* measuring features and defects
 still annotations. *See* annotations
 storage case, 14
 storage devices. *See* removable storage devices
 storage procedure, 32–33
 storage reel. *See* funnel
 storage temperature, 131
 strap. *See* shoulder strap
 streaming video, 5, 45, 80, 86
 S-video input and output, 10
 symbols, safety, 17
 system settings, 44
 system storage case, 14

T

technical support, iii
 telephone numbers, iii
 temperature, operating and storage, 131
 temperature sensor, 9
 text annotations. *See* annotations
 text color, 42
 text-entry screen, 62
 thumbnail screen, 73
 time and date settings, 44, 129
 tip map, 44
 tips. *See* optical tips
 tools, internal working channel, 150
 training, 1
 transferring files. *See* PC communications
 trigger, 7, 50
 troubleshooting, 113, 127–129

U

umbilical. See handset cable
unit (device) name, 45
units, measurement, 43
unscaled display setting, 44
update to software or features, 44, 144
uploading files. See PC communications
USB-based storage devices. See removable storage devices
USB connectors, 10

V

vehicle inverter, 24
ventilation, 19, 27, 33
VGA output, 11
video files
 managing, 73–86
 selecting quality of, 41, 69
 working with, 67–72
video input and output connectors, 10, 11
Video Recording Options menu, 145
Video Record menu, 145
video streaming, 5, 45, 80, 86
virtual keyboard, 78
 See *also* text-entry screen
volume control, 39

W

“warning,” definition of, 17
 See *also* safety
warranty, 139
water, probe’s compatibility with, 137
.WAV files. See audio files
Web access, 5, 78
Web site for GE Inspection Technologies, iii
white balance, 119
wide-angle distortion correction, 4, 56
wireless (WiFi) communications, 5, 35–??, 45
writing files. See PC communications

X

XL PRO compatibility, 87

Z

zooming, 44, 58

